



The NOTEBOOK

BOONTON RADIO COMPANY · ROCKAWAY, NEW JERSEY

A Division of Hewlett-Packard Company

FEB 25 1963

New Techniques In FM Linearity Measurement

JOHN P. VAN DUYNE, *Engineering Manager*

INTRODUCTION

It has been characteristic of the development of electronic systems and terminal equipment that effort has been continually devoted to methods of making the output of the equipment or system more faithfully reproduce the important characteristics of the input. A major consideration of this nature has been improvement in the linearity of the transfer characteristics of devices, equipment, or systems. While there are equipment and devices in which some function, other than a straight line, is wanted between the input and output, the straight line or linear relationship is by far the most common. There are several detailed motivations for this activity which have slightly different connotations in various fields of endeavor. However, it is possible to generalize on some of the factors that push development in the direction of improved linearity of transfer characteristic. In the fields of communication equipment development, extreme linearity did not become of major importance until these systems were directed toward more efficient use of the frequency spectrum. This frequently results in multiple channel transmission in which nonlinearity of the transfer characteristic causes unwanted cross-talk between the various channels.

In recent times, the use of communications type systems for the transmission of scientific, commercial, and other forms of data has become common. Since the information being transmitted has other than a subjective end result, the accuracy of data transmission is related to the linearity of the transfer

E_{f_0} = CONSTANT AMPLITUDE "SEARCH" VOLTAGE
 V_1, V_2, V_3 = ARBITRARILY CHOSEN OPERATING POINTS
 $\Delta f_{01}, \Delta f_{02}$ = FREQUENCY DEVIATION AT RATE ΔV AT OPERATING POINT V_k
 K_{f_0} = SLOPE OF SOLID CURVE AT ANY POINT X
 $\Delta f_{0k} = K_{f_0} \cdot E_{f_0}$
 AS $E_{f_0} \rightarrow 0$ $\frac{\Delta f_{0k}}{E_{f_0}} \rightarrow \frac{df}{dE}$

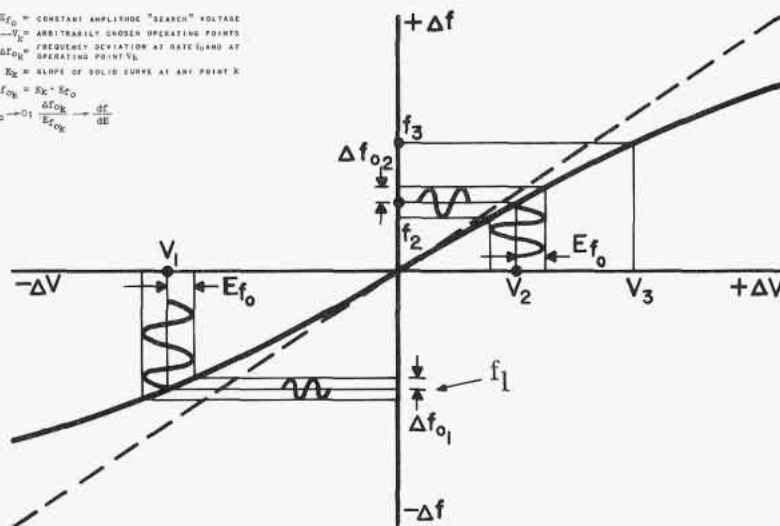

Figure 1. Transfer Characteristic with Typical Nonlinearity

characteristic. Even in the field of entertainment electronics, pressure for more faithful reproduction has been continuous. A recent development in this field, that of a system of FM Stereo Multiplex transmission,^{1, 2} has forced the manufacturers of FM transmitters and receivers for the entertainment field to improve the linearity of their equipment to minimize cross-talk between the Monaural and Stereo channels of the system. One fact that should be noted is that, because of the different objectives and the different technologies which have developed around these objectives, the effects of nonlinearity in the transfer characteristic are described in many different terms.

GENERAL COMMENTS ON NONLINEAR DISTORTION

Before discussing the detailed techniques of measurement, it might be well to consider what we really mean by "nonlinearity", and the distortion which results therefrom. Nonlinearity, as used in this discussion, refers to that characteristic of a circuit which causes the output to be related to the input

by other than a straight line function. As a result, the circuit may not be specified by linear differential equations with time as the independent variable.³

Many terms are used to describe distortion due to this concept of nonlinearity. In order that we may clearly understand the problems, a few definitions will be resorted to. *Nonlinear Distortion* has been defined by the IRE Standards on Circuits as "Distortion caused by a deviation from a desired linear relationship between specified measures of the output and input of a system."

NOTE: The related measures need not be output and input values of the same quantity; e.g., in a linear detector, the desired relation is between the output signal voltage and the input modulation envelope."

Other names used to describe the effects of nonlinear distortion are *Amplitude Distortion*, *Waveform-Amplitude Distortion*, and *Harmonic Distortion*. In addition to these names, there are specific means of measuring nonlinearity among which are *Total Percent Harmonic Distortion* and *Inter-*

YOU WILL FIND . . .

New Techniques in FM Linearity Measurement	1
BRC Appoints Four New Engineering Representatives	7
Editor's Note - BRC Assumes Divisional Status	8

THE BRC NOTEBOOK is published three times a year by the Boonton Radio Company, a Division of Hewlett-Packard Company. It is mailed free of charge to scientists, engineers and other interested persons in the communications and electronics fields. The contents may be reprinted only with written permission from the editor. Your comments and suggestions are welcome, and should be addressed to: Editor, THE BRC NOTEBOOK, Boonton Radio Company, Green Pond Rd., Rockaway, N. J.

modulation Distortion. It should be stressed, that while there may be different names for the effects of non-linearity and many different standard ways of expressing the effects numerically, all of these related types of distortion stem from the same nonlinearity of the transfer characteristic as discussed above.

The casual reader of papers on distortion in the field of sound reproduction, may be left with the feeling that, somehow, there is a large difference between intermodulation distortion (IM) and total percent harmonic distortion (HD). While there may be advantages in one system of measurement or the other, when it is desired to relate the numerical result of the measurement to the subjective response of the listener, it should be remembered that finite results in either an IM or HD measurement occur due to nonlinearity of the transfer characteristic, and measurement by either method may be analytically related for any specific shape of curve. Further discussion of this may be found in Reference 4.

A related case occurs in the measurement of deviation from a frequency modulated source by zero beating another RF source with the peak excursions of the FM carrier. Then, the frequency of this source, for zero beat with the upper and lower FM excursions, is measured and compared with the unmodulated FM carrier. Equality of these differences has sometimes been taken as evidence of good linearity. That this is not so, can be seen in Figure 1. Since voltages V_1 and V_3 have been chosen equal and opposite, and the resulting frequencies, f_1 and f_3 , are equidistant from the origin, the condition of the beat frequency measurement is described. However, the transfer characteristic shown is anything but linear. It is true, though, that the symmetry about the unmodulated carrier, so measured, indicates a predom-

inance of odd-order harmonic distortion. Asymmetry about the unmodulated carrier is a strong indication of even-order distortion.

Many observers have commented on this so called "FM carrier shift" or difference in frequency between the average carrier frequency (when modulated) and the unmodulated carrier. This is due to the "DC" or constant term which appears in a Fourier expansion of the polynomial representation of a transfer function with even-order curvature (second harmonic or "squared" terms), and is a reliable indication of the presence of even-order harmonic distortion; usually second harmonic.

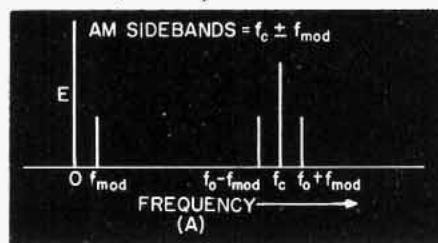

Figure 2A. Undistorted AM Spectrum

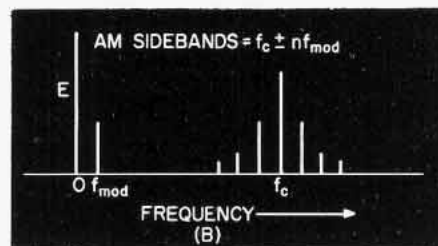

Figure 2B. Distorted AM Spectrum

FM SIGNAL GENERATOR MEASUREMENT

In the development of the Type 202J and 202H FM Signal Generators, Boonton Radio Company faced a specific aspect of the nonlinearity problem. Since we were designing a linear frequency modulator, it was necessary that we be able to measure the transfer characteristic nonlinearity of this modulator to a high degree of precision. An obvious way to accomplish this would be to measure the results of frequency modulation through a perfectly linear demodulator. However, it is somewhat difficult to produce the perfect demodulator without having a perfect modulator with which to measure it. Therefore, another method was needed. Let us examine some common techniques.

In the simple case of amplitude modulation, it is possible, by means of a suitable wave analyzer, to measure the frequency spectrum resulting from the

modulation process. If the modulating signal is free of distortion and the modulation process is perfectly linear, the resulting spectrum in the vicinity of the carrier will contain only the carrier and the two sidebands, separated from the carrier by the modulation frequency as seen in Figure 2A. If nonlinearity of the transfer characteristic exists, the results may be as shown in Figure 2B. Here, the appearance of sidebands, separated from the carrier by integral multiples of the modulating frequency, is not only qualitative evidence of non-linear distortion, but affords a measure of this distortion if the amplitudes of all the sidebands relative to the carrier are determined.

In the FM case, for deviations and modulation frequencies for which the modulation indices, defined as

$$m = \frac{\text{peak deviation}}{\text{modulating frequency}}$$

are appreciably greater than unity (the usual case), the resulting frequency spectrum becomes exceedingly complex, even for an undistorted modulation process.⁵ In the presence of nonlinearity of the frequency modulator, the spectrum becomes even more complex; thus ruling out spectrum analysis as a simple means of measuring nonlinearity.

A second method for measuring a frequency modulator transfer characteristic is possible, if the modulator is capable of operation at dc. This method consists of modulating voltage and measuring the resulting frequency increment. Its precision is limited by the stability of the carrier frequency in the absence of modulation and the ability to read small increments in voltage and frequency precisely. Modern measuring equipment has solved the latter two problems, but not the former.

In addition to the matter of precision, it was desired by BRC to be able to make adjustments on the frequency modulator for minimum nonlinearity as a result of an instantaneous display of nonlinearity of the frequency modulator. This same need is felt by designers and manufacturers of FM transmitters and receivers.

DEVELOPMENT OF THE METHOD

In order to best understand the method to be described, let us avoid specific numbers or circuits, and resort to a general discussion of a circuit which relates a change in voltage to a change in fre-

quency or vice versa. This covers the general case of frequency modulators and demodulators. Reference to Figure 1 will show the transfer characteristic of such a circuit. The horizontal axis represents changes in voltage and the vertical axis changes in frequency. Either may be the independent variable for purposes of our discussion. Shown dotted is a reference straight line which passes through the origin, as does the arbitrary nonlinear curve. Our problem is to measure the departure of the actual curve from the ideal straight line. A corollary to this problem is to define the initial relationship of the straight line to the actual curve. This may be done in several ways. It has been common for people in the telemetry and data transmission field to be interested in the instantaneous departure of their actual transfer characteristic from the ideal straight line. This stems from their historical use of such characteristics to transmit simple analog information. Several ways have been used to express this, but a common one is illustrated in the performance specification of the BRC 202J Telemetry Signal Generator. Here, the reference straight line chosen is that line for which the rms sum of the differences between the actual curve ordinates and the straight line ordinates is a minimum. Another method would be to have the average departure a minimum, or the peak departure a minimum. For small, low order, nonlinearities, there is little difference between these cases.

Figure 1 shows that one way to describe the departure of the curve from the straight line is to measure a large number of individual ordinates of the actual curve, subtract them from the ordinates of the straight line, and report the differences in tabular or curve form. This type of data would result from a point-by-point measurement of the characteristic, using an electronic counter to measure the frequency and a precision incremental voltmeter for the voltage axis. This technique is not instantaneous, even when automated, and yields more data than can be conveniently digested quickly.

It is also evident in Figure 1, that if the slope of the actual curve could be compared, at any point, with that of the straight line, a relationship covering the nonlinearity could be readily developed. Pursuing this line of reasoning, it should be possible to make an incremental measure of the slope of the curve by introducing a small amplitude

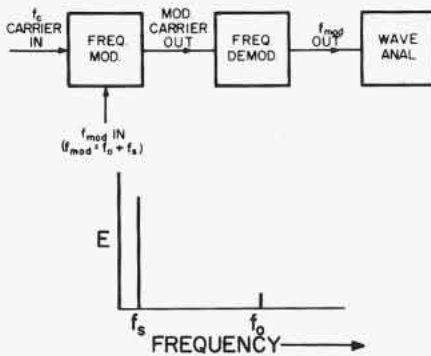

Figure 3A. Linear AM and FM Demodulator with Output Spectrum

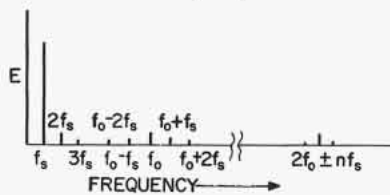

Figure 3B. Nonlinear FM Demodulator - Linear FM Modulator Spectrum

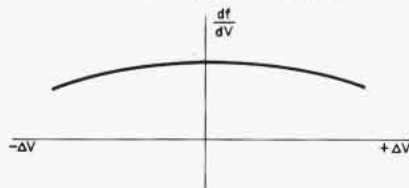

Figure 3C. Plot of df/dV of Figure 1

sine wave of voltage, E_{r_0} , (if voltage were the desired independent variable) superimposed on a direct voltage. The direct voltage may then be varied. If the resulting frequency variation, due to the small constant amplitude search voltage E_{r_0} , were measured at each value of V , and plotted as a function of V over the entire range of interest of the voltage axis, a plot of the varying slope of the actual transfer characteristic would result. The extent to which this departs from the slope of the straight line, is a measure of the nonlinearity of the transfer characteristic. This method sounds relatively laborious, until it is realized that this can be done dynamically by allowing V to vary over the desired dynamic range at a sinusoidal rate, f_s . The slope of the transfer characteristic can be plotted on an oscilloscope by driving the vertical axis with an amplitude proportional to Δf and the horizontal axis with a voltage proportional to V , and varying at rate f_s .

Let us now consider the case of a linear frequency modulator and frequency demodulator, to which we will apply the two test voltages, E_{r_0} and V_{r_0} , with the understanding that V_{r_0} is of

such magnitude as to sweep through the entire dynamic range of interest and that E_{r_0} is very much smaller than V_{r_0} , typically one-tenth as great. This situation is shown in Figure 3.

As might be expected, the output spectrum of the linear demodulator driven by the linear modulator is simply E_{r_0} and V_{r_0} , with the amplitude relationship established by the input. If we now further assume that the frequency modulator is linear, but that the frequency demodulator is nonlinear (curve of the nature shown in Figure 1), we realize that if E_{r_0} were to be plotted as a function of V_{r_0} , we would approximately plot the slope of the transfer characteristic being studied, namely, that of the assumed nonlinear demodulator. Therefore, we may write

$$\text{that } \Delta f = \frac{df}{dV} (E_{r_0}), \text{ where } df/dV$$

is recognized as the slope of the transfer characteristic in Figure 1.

Another view of the same phenomena is shown in Figure 3B. This shows the output spectrum of the nonlinear demodulator driven by the linear modulator, and with the input as assumed previously. The output spectrum is now far more complicated than in the linear case (Figure 3A), consisting not only of V_{r_0} and E_{r_0} , but also of integral multiples with decreasing amplitude of both f_s and f_0 , and sum and difference frequency terms resulting from the nonlinearity of the transfer characteristic.

Figure 3C shows the df/dV curve as determined by plotting the amplitude of Δf from the demodulated output as a function of V_{r_0} . This would be an accurate plot of the transfer characteristic slope if the magnitude of E_{r_0} in the input were made vanishingly small compared to V_{r_0} . For the cases studied by the writer, this approximation is entirely satisfactory if $V_{r_0}/E_{r_0} \approx 10$. It should be emphasized that Figure 3C and the spectrum plot of Figure 3B contain the same information concerning the transfer characteristic nonlinearity, but displayed in a different manner. The question now is, how may we simply achieve such a display?

The block diagram of Figure 4 shows the introduction of a bandpass filter which accepts f_0 and the significant sidebands about it due to f_s , and the display of the resulting carrier envelope on the vertical axis of an oscilloscope. The horizontal axis is driven by the initiating V_{r_0} from the input of the frequency modulator. Figure 5 shows a

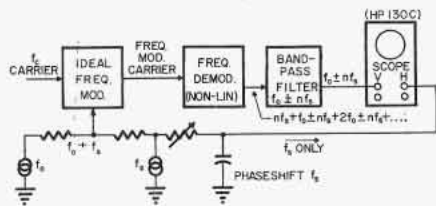

Figure 4. Block Diagram of Circuit Used to Provide Instantaneous Display of Transfer Characteristic Change of Slope

typical result. Since we have passed our demodulated signal through a bandpass filter, the upper and lower section of the envelope presented to the oscilloscope must be symmetrical; therefore, we may select either for consideration. (The final equipment shown in Figures 10 and 11 chose the negative half of the envelope for display.) Where the amplitude of the f_s sidebands about f_c is very low, as would be true of a highly linear circuit, the resulting departure of the oscilloscope trace from a rectangle is small. Since we may ignore half the envelope, it is possible to offset the centering of the oscilloscope and greatly expand either half of the display. If an oscilloscope, such as the Hewlett-Packard 130C, is used, linearity of the display will be maintained for an expansion of half the envelope by 10 times. This permits measuring changes in slope down to about 0.1% of one-half the envelope.

The departure of the envelope in this display from a reference value (chosen as the slope at the origin of Figure 1, and appearing on the vertical center line of the oscilloscope display

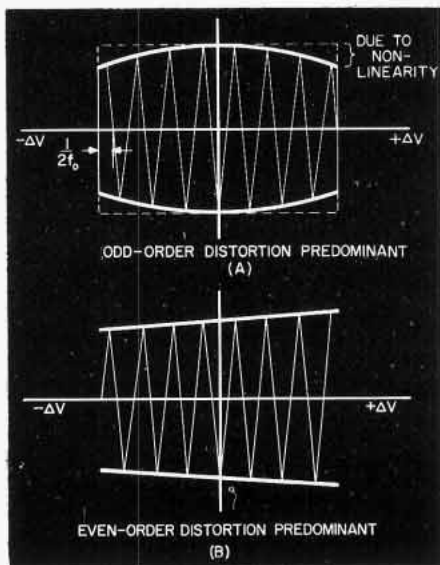

Figure 5. Typical Display from Circuit in Figure 4.

in Figure 5), is a direct measure of the change in slope of the transfer characteristic. Therefore, the slope of this curve is approximately the second derivative of the transfer characteristic. If the envelope of Figure 5 shows symmetry about the vertical center line of the trace (Figure 5A), it can be shown that this is a result of odd-order (3rd, 5th, etc.) harmonic distortion. If the envelope is asymmetrical about the vertical center line and has mirror image symmetry about the horizontal center line (Figure 5B), the distortion is largely even-order (2nd, 4th, etc.) Thus, it can be seen, that much information is contained in the displays of Figure 5, produced by the circuit of Figure 4.

Up to this point in the discussion, we have been assuming a linear modulator. The reader may well comment, "This is all fine, but where do I get the perfectly linear modulator?" The technique illustrated in the block diagram of Figure 6 shows a method of "synthesizing" an FM signal, modulated simultaneously by two frequencies (f_o and f_s), in which sidebands of f_s around f_o are not produced, even though the individual signal generators have some nonlinear distortion. The technique used is borrowed directly from the receiver practice of mixing an incoming signal with a local oscillator and amplifying at a fixed intermediate frequency before frequency demodulation is performed. Let us then consider the linearly demodulated spectrum produced by modulating either signal generator by a single frequency, remembering that one generator is modulated by f_s and the other by f_o .

The output spectrum from a perfect demodulator driven by a nonlinear modulator with single frequency input would consist of the original modulating frequency and integral multiples of this frequency, generally in decreasing magnitude. Since the two frequencies f_s and f_o do not simultaneously exist in either frequency modulator, it is not possible to produce sum and difference frequencies in the linearly demodulated output. (See Figure 7.) When the carrier frequencies (f_{c1} and f_{c2}) generated by the two FM sources (one modulated by f_s and the other by f_o) are mixed at RF (Figure 6), and the difference carrier frequency is amplified by a suitable selective amplifier, the instantaneous frequency in the selective amplifier is the simple arithmetic difference

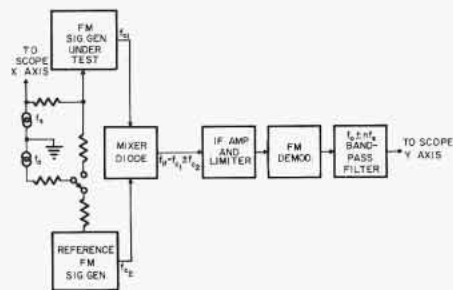

Figure 6. Block Diagram of Circuit for Synthesizing Perfectly Linear Modulation

of the instantaneous frequency modulated sources. Thus, no sum and difference frequencies of the modulating signals f_o and f_s appear in the FM signal at average frequency, f_{if} .

Now, following the technique discussed previously, let us introduce a bandpass filter centered on f_o in the output of the demodulator. The bandwidth of this filter must be wide enough to accept the significant sidebands of f_s about f_o . For the cases studied by the writer, acceptance of sidebands up to the 3rd is sufficient. This bandpass is shown by dotted lines in Figure 7. It will be seen that this filter eliminates f_s and all of the distortion products due to the nonlinearity of the frequency

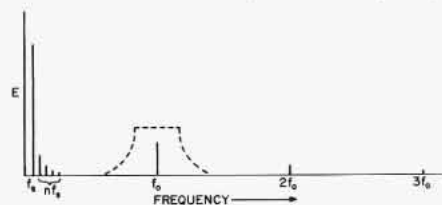

Figure 7. Demodulator Output Spectrum of $n f_s$ and $n f_o$ with Superimposed Bandpass Filter - Linear Case

modulators in the individual signal generators which produce the difference frequency, f_{if} .

Now, let us consider the effect of nonlinearity in the frequency demodulator when driven by a signal generated by the circuit of Figure 6. It is evident from the previous discussion, that the spectrum will consist not only of the components shown in Figure 7, but of sidebands about f_o and its harmonics spaced by $n f_s$. (See Figure 8.) If the output of the bandpass filter is connected to an oscilloscope, as discussed previously, an envelope, similar to that of Figure 5, will be seen. Thus, we have a technique for using two signal generators of finite modulator nonlinearity to synthesize an apparently distortionless signal which may then be

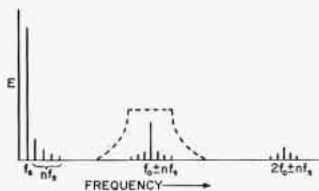

Figure 8. Demodulator Output Spectrum of nf_s and nf_s , including nf_s Sidebands About f_c - Nonlinear Case

used to measure the nonlinearity in a frequency demodulator.

To avoid the necessity of offsetting the axis of the oscilloscope display and expanding the scale to look at small deviations of the envelope from rectilinearity, it is possible to eliminate the carrier with a linear amplitude demodulator. The composite block diagram of Figure 9 shows the application of a simple linear AM detector followed by a low-pass filter to eliminate the carrier, f_c , from the display. The output from the linear detector will be a direct current component proportional to the peak amplitude of f_s , together with the envelope produced by the nf_s sidebands beating with the carrier. The percentage change in slope, compared to a straight line, may be read by expressing the peak value of the demodulated envelope as a percentage of the dc component (which is proportional to the peak value of f_s).

If the output of the AM detector and nf_s low-pass filter is read on an averaging meter, an average value of the percent change in slope will be read. For the cases studied by the writer, the amplitude of the significant harmonics (2nd and 3rd) of f_s has been relatively low, so that the value read by an rms calibrated, average reading meter (such as the Hewlett-Packard 400D) closely approximates the rms value of the departure of the slope of the transfer characteristic from the constant slope of the ideal straight line. Since the departure of the transfer characteristic of Figure 1 from a straight line necessitates a change in the slope of the transfer characteristic, it is seen that these are related effects. Calculations have shown that the numerical values for percent change in slope, as described above, are always less than the values for percent departure of the transfer characteristic from a straight line. The specific relationship depends on the actual shape of the curve. However, for transfer characteristics experienced in FM modulators and demodulators, the ratio of percent departure

from a straight line to percent change in slope from that of a straight line varies from 1/2 to 1/3. Thus, a measurement of 1% change in slope insures a departure of the transfer characteristic from a straight line of less than 1%.

Figure 9 shows a composite block diagram of the entire setup with a few additional features. Instead of separately modulating the Signal Generator under test and the reference Signal Generator with f_s and f_c , respectively, if the Signal Generator under test is simultaneously modulated by f_s and f_c (by switching S_1) the change in slope of the frequency modulator of the Signal Generator under test will be superimposed upon that of the FM demodulator. Thus, if the individual ordinates of the display produced by the block diagram in Figure 9 are noted for the case of separate modulation, and then determined for the case of simultaneous modulation of the Signal Generator under test, the algebraic difference of these ordinates will produce a curve which is due to the nonlinearity of the Signal Generator under test only, and does not depend upon that of the frequency demodulator. Note that when switching f_s from one generator to the other, the horizontal polarity of the display is reversed.

Thus, we have developed a circuit and measuring technique which will measure the change in slope of a frequency modulator largely independently of the demodulator, as well as the change in slope of the demodulator independently of the frequency modulator. Many additional refinements are possible to the basic circuit of Figure 9 to speed up the measurement. Some of these features are:

1. An ac voltmeter, calibrated di-

rectly in kc deviation may be connected to the output of the discriminator. Methods of calibration are covered in Reference 5.

2. A dc meter may be used to indicate the level of the demodulated magnitude of f_s .

3. If the dc meter indication is kept constant, an ac meter on the output of the nf_s bandpass filter may be calibrated directly in percent change in slope.

4. Switching may be added to facilitate the alternate connection of f_s and f_c to separate or to a common signal generator (S_1 in Figure 9).

A photograph of such equipment, used in the production test of BRC 202H and 202J Signal Generators, is shown in Figure 10. It should, of course, be noted that the FM demodulator used must be preceded by an excellent amplitude limiter, or spurious effects will occur which are not measures of the true nonlinearity of the frequency modulator or demodulator. In the equipment shown, normal circuits have proven satisfactory. The particular discriminator used was centered at 21 mc and is approximately 5 mc wide, so that the resulting change in slope for deviations of ± 150 kc is less than 0.2% peak. This high degree of linearity permits direct measurement of signal generator nonlinearity without the need for calculation. In addition, it permits direct measurement of total percent harmonic distortion of a signal generator by the connection of a good distortion analyzer (such as the Hewlett-Packard 330B) to the output of the discriminator.

Figure 11 shows several cases of nonlinearity displayed by the BRC production test equipment shown in Figure 10. The scale calibration is such

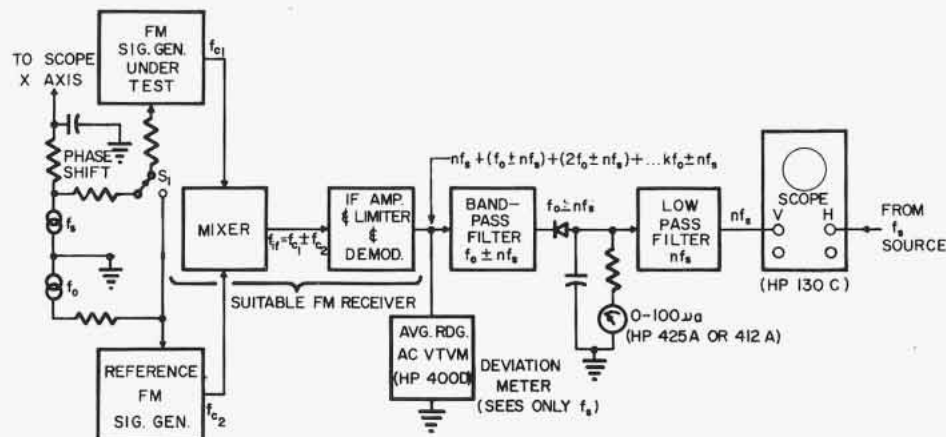

Figure 9. Block Diagram of Circuit Used to Obtain Change of Slope Display

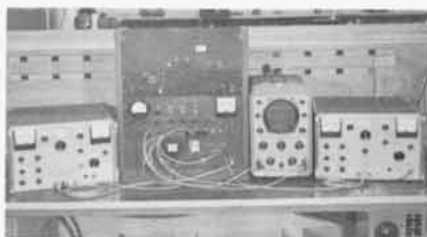

Figure 10. BRC Production Test Station

that a peak-to-peak amplitude of 1.0 cm represents 1% total change in slope.

In this particular equipment, $f_c = 50$ cps and V_{r_s} is set for 150 kc deviation. A frequency of 100 kc was chosen for f_o and E_{r_s} is set for about 15 kc deviation. Almost any other choice of frequencies may be made, subject to the availability of suitable filters; however, f_o should not exceed 100 kc.

Figure 11A shows the change in slope of the BRC production test discriminator alone. This discriminator, plus a properly adjusted 202J Signal Generator, is shown in Figure 11B. Figure 11C shows a typical case of incorrect setting of the operating point of the reactance tube in a 202J Signal Generator. With this display, it is a simple matter to readjust the bias for minimum nonlinearity of the frequency modulator. Resulting changes in carrier frequency must be corrected. A properly set up 202J Signal Generator will show a percent change in slope of less than $\pm 1\frac{1}{2}\%$.

EQUIVALENT FIELD TECHNIQUE

It is possible to utilize the method described above without the complex, specialized equipment shown in Figure 10. This equipment was designed for a particular production test operation and has many features unnecessary to the person who must occasionally adjust a frequency modulator or demodulator for maximum linearity. The circuit of Figure 12 permits the application of our method with readily available commercial instruments. The only special piece of apparatus required is the $f_o \pm nf_s$ bandpass filter and the nf_s low-pass filter which may be readily constructed from the values shown in Figure 12. Should a suitable oscilloscope (such as the Hewlett-Packard 130B or 130C) be available, the refinement of the amplitude demodulator and the nf_s low-pass filter may not be needed.

For FM demodulators of high output impedance, a good electronic voltmeter (HP 400D, etc.) may be used

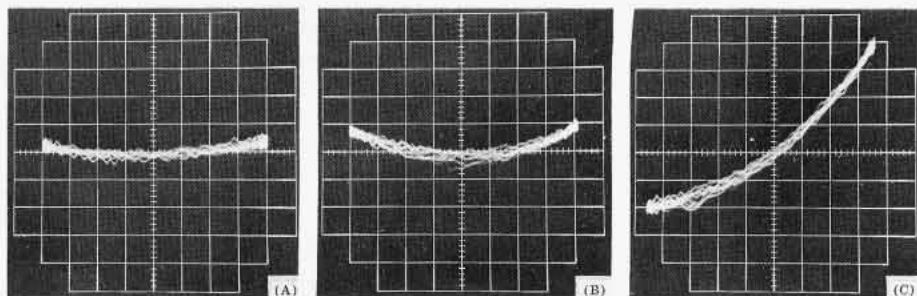

Figure 11. Typical Change of Slope Displays Obtained from Setup in Figure 10.

to provide high input and low output impedance and some attenuation (in 10 db steps). Many telemetry receivers have cathode follower or other low impedance outputs which will drive the 4K ohm bandpass filter impedance adequately. To avoid nonlinearity caused by the voltmeter diodes, the diodes should be shorted out.

The nf_s low-pass filter includes a resonant impedance transformer ($Q \leq 5$) to give a high enough level to the AM demodulator to insure good linearity of the change of slope display. Its output should be checked by the oscilloscope envelope method to insure accuracy.

While it is desirable that the frequency demodulator used be sufficiently linear to permit measuring the signal generator nonlinearity directly, this may be difficult to realize in the field. Therefore, it is essential that the two signal generator method (separately modulated) of Figures 6 and 9 be employed in order to measure or minimize

the nonlinearity of the frequency demodulator. After adjustment for minimum nonlinearity, a "grease pencil" trace may be made on the oscilloscope reticule of the nonlinearity (expressed as percent change in slope) of the demodulator. Switching to simultaneous modulation of the signal generator being adjusted will alter the pattern, due to the nonlinearity of this generator. Allowance must be made for the pattern reversal on the horizontal axis, or the polarity of f_s applied to the generator under test may be reversed. It is then necessary to readjust the reactance tube bias of the signal generator to most nearly equal the change of slope curve of the demodulator traced on the oscilloscope reticule. It is obvious that the method becomes inaccurate when the nonlinearity of the demodulator is large compared to that of the signal generator.

RECEIVER ADJUSTMENT

The equipment setup of Figure 12, with one significant addition, can be

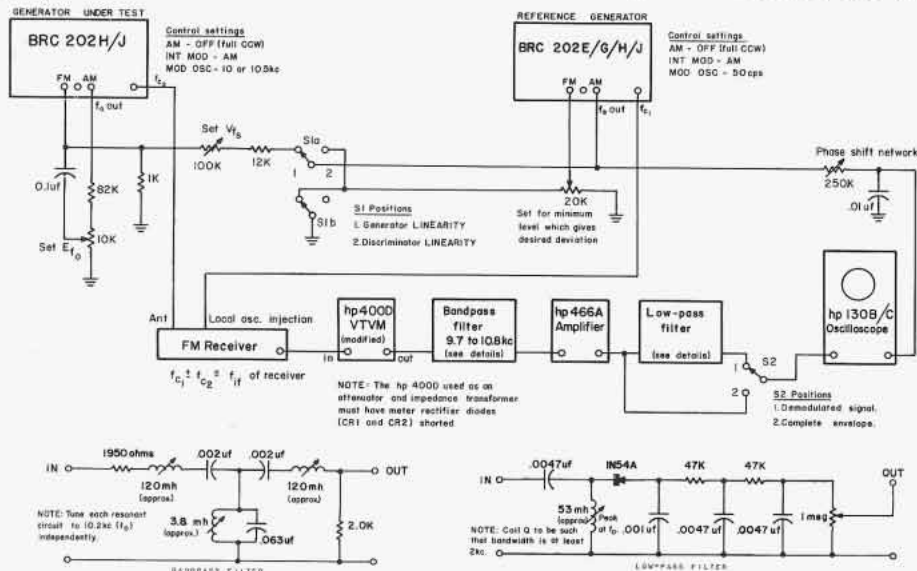

Figure 12. Block Diagram of Setup for Adjusting FM Modulator or Demodulator for Maximum Linearity Using Commercially Available Equipment

used to adjust an FM demodulator for maximum linearity, even in the absence of the complete FM receiver. Substitution of a suitable commercial RF mixer for the receiver front end, followed by one or two of the BRC 230A Signal Generator Power Amplifiers (which provide 24 to 30 db gain) will frequently permit proper drive levels to a limiter and demodulator circuit under development. This use of the 230A facilitates the detailed experimental evaluation of an FM limiter and demodulator prior to the availability of the rest of the receiver. Having substituted the 230A and a commercial mixer for the receiver front end, it is only necessary to proceed as previously outlined. In order to minimize the effects of residual amplitude modulation in the FM signal generator, it is desirable to operate the level of the beating signal generator 6 to 10 db lower than that of the frequency-modulated generator. This allows the diode mixer to minimize the unwanted amplitude envelope due to the tuned carrier bandpass circuits in the signal generator.

When displaying the nonlinearity of the demodulator, it is desirable to vary the carrier level of the generator under test with its attenuator to show that proper amplitude limiting is provided ahead of the frequency demodulator.

In setting up the equipment of Figure 12, the use of 202H and J Signal Generators reduces the needed external instruments over that required with other signal generators. Since the 202H and J (and also 202E, G, etc.) include an AF oscillator, it is possible to use this oscillator for the search voltage (E_{t_0}) and the sweep voltage V_{t_0} . The connections of the AM and FM terminals to accomplish this are shown in Figure 12. It is extremely important, though, to keep the AM controls full counterclockwise to avoid unwanted AM of either carrier.

The filter bandwidth is adequate to be used with both the 10 kc AF of the 202H and the 10.5 kc of the 202J.

When aligning a 202H, after following the procedure to achieve minimum nonlinearity, if the demodulator is appreciably more linear than the 202H, a total percent harmonic distortion reading may be meaningfully made.

CONCLUSION

In conclusion, let us summarize the following points:

1. The general definition of distortion resulting from transfer characteristic nonlinearity has been given, together with qualitative relationships between various types of nonlinear distortion and methods of expressing them.

2. A technique for producing an essentially linear frequency-modulation signal from two relatively imperfect signal generators has been described. This technique permits the accurate measurement of demodulator nonlinearity in the presence of practical levels of modulator nonlinearity in terms of the departure of the slope of the transfer characteristic from that of a reference straight line. Having achieved this measurement, it is then possible to measure the nonlinearity of frequency modulators by calculating out, or eliminating, the nonlinearity of the demodulator in the composite display. This method results in an instantaneous dynamic display which facilitates adjustment of either the modulator or demodulator.

3. An equipment setup has been shown which permits the application of the technique in the field with commercially available test equipment, presuming a suitable frequency modulation receiver or demodulator is available.

Similarity of the techniques discussed here to the Intermodulation Distortion

method of C. J. LeBel⁷ will be seen. However, the numerical results of LeBel's method depend critically on the amplitude ratio of the two signals, while, in the change of slope method, it is only necessary that E_{t_0} be sufficiently small to truly measure slope. V_{t_0} is chosen for the desired deviation being studied.

REFERENCES

1. Van Duyne, J. P., "A Modulator for the New FM Stereo System", BRC Notebook No. 30.
2. Appendix to FCC Docket 13506, "Amendment of Part 3 of the Commission's Rules and Regulations to Permit FM Broadcast Stations to Transmit Stereophonic Programs on a Multiplex Basis."
3. "IRE Standards on Circuits: Definitions of Terms in the Field of Linear Varying Parameter and Nonlinear Circuits", IRE Standard, 53 IRE 4.S1, Proc. of the IRE, March 1954, page 554.
4. Warren, W. J. and Hewlett, W. R., "An Analysis of the Intermodulation Method of Distortion Measurement", Proc. of the IRE, April 1948, pages 457-466.
5. Wachter, J. E., "A Method of Measuring Frequency Deviation", BRC Notebook No. 9, page 5.
6. Hilliard, J. K., "Intermodulation Testing" Electronics 19.7, July 1946, page 123.
7. LeBel, C. J., "A New Method of Measuring and Analyzing Intermodulation", Audio Engineering 35.7, July 1951, page 18.

BRC APPOINTS FOUR NEW ENGINEERING REPRESENTATIVES

Boonton Radio Company recently announced the appointment of four new east-coast engineering representatives: Horman Associates, Inc., RMC Sales Division and Robinson Sales Division of Hewlett-Packard Company, and Yewell Associates, Inc.

Horman Associates, Inc. has its headquarters in Rockville, Maryland, a suburb of Washington, D.C., and a branch office in Baltimore. RMC has two offices: the main office in New York City, and a branch office in Englewood, New Jersey. Robinson Sales Division has three offices, with headquarters located near Philadelphia in West Conshocken, Pennsylvania, and branch offices in Camp Hill, Pennsylvania, and Asbury Park, New Jersey. Yewell Associates, Inc. has its main office in Burlington, Massachusetts, with branches in Middletown, Connecticut, and Poughkeepsie, New York.

With the appointment of RMC, Robinson, Horman, and Yewell, BRC expects to further improve customer services to its many customers. "Chuck" Quinn, who previously had been handling a portion of this territory from the factory, will still be on hand to assist customers with their special application problems.

The complete story on our new representatives, including an introduction to their key personnel, will be presented in the "Meet Our Representatives" series which will be resumed in the next issue of the Notebook. Meantime, we urge our customers in the areas served by these new representatives to call or write them for information about BRC equipment.

A complete list of addresses and telephone numbers for all BRC Engineering Representatives appears on page 8 of this issue.

EDITOR'S NOTE

BRC Assumes Divisional Status

Boonton Radio Corporation, a subsidiary of the Hewlett-Packard Company since 1959, assumed divisional status November 1, 1962. At that time, BRC's name was changed to Boonton Radio Company.

The conversion of BRC to a division of the Hewlett-Packard Co. is a part of an over-all program to achieve greater flexibility of the entire HP organization and to improve operating efficiency. This change will in no way affect BRC policies or product line, but will permit us to offer improved and expanded services to our customers.

Mr. William D. Myers, formerly manufacturing manager of HP's Microwave Division in Palo Alto, has been named general manager of the new Boonton Radio Division. Mr. Myers

joined HP in 1944 as a development engineer and has since held a number of executive positions, including manager of quality-control engineering.

A native of San Jose, California, Mr. Myers is an electrical engineering graduate of Stanford University and a senior member of the Institute of Radio Engineers.

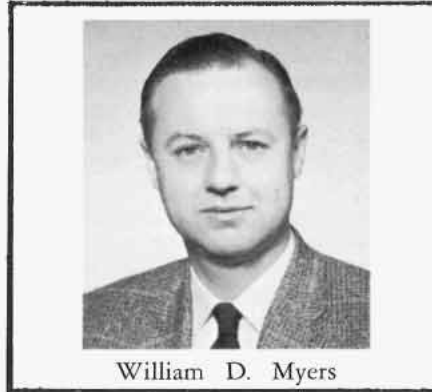

William D. Myers

BRC Wins

"New Good Neighbor" Award

Boonton Radio Company was one of ten winners in the third annual "New Good Neighbor" contest, a state-wide contest sponsored by New Jersey Business Magazine, a service of the New Jersey Manufacturers Association. Nominations for the contest are made by the mayors of the communities in which new buildings are located. Winners are selected by a panel of noted business and civic leaders and architects. Points considered in the judging are: the general attractiveness of the building and its economic value to the community, and the company's overall community relations approach and effectiveness.

BRC is indeed happy to have been selected a winner in the contest and is proud of its "good neighbor" role in the community.

Engineering  Representatives

*ALBUQUERQUE, New Mexico
NEELY ENTERPRISES
6501 Lomas Blvd., N.E.
Tel: (505) 255-5586
TWX: 505-243-8314

ASBURY PARK, New Jersey
ROBINSON SALES DIVISION
Hewlett-Packard Company
1317 Railroad Ave.
Tel: (201) 531-3150
TWX: 201-531-1331

*ATLANTA 5, Georgia
BIVINS & CALDWELL, INC.
3110 Maple Drive, N.E.
Tel: (404) 233-1141
Tel: 404-231-4720

BALTIMORE, Maryland
HORMAN ASSOCIATES, INC.
3006 W. Cold Spring Lane
Tel: (301) 664-4400

*BOSTON, Massachusetts
YEWELL ASSOCIATES, INC.
Middlesex Turnpike
Burlington, Mass.
Tel: (617) 272-9000
TWX: 617-272-1426

*CHICAGO, Illinois
CROSSLEY ASSOCIATES, INC.
2501 W. Peterson Ave.
Tel: (312) 275-1600
TWX: 312-222-0311

*CLEVELAND, Ohio
S. STERLING COMPANY
5827 Mayfield Road
Tel: (216) 442-8080

*DALLAS, Texas
EARL LIPSCOMB ASSOCIATES
3605 Inwood Road
Tel: (214) 357-1881
TWX: 214-899-8541

*DAYTON, Ohio
CROSSLEY ASSOCIATES, INC.
2801 Far Hills Ave.
Tel: (513) 299-7002
TWX: 513-944-0090

*DENVER, Colorado
LAHANA & COMPANY
1886 South Broadway
Tel: (303) 733-3791
TWX: 303-292-3056

*DETROIT, Michigan
S. STERLING COMPANY
21250 10-1/2 Mile Road
Southfield, Michigan
Tel: (313) 442-5656
TWX: 313-357-4615

ENGLEWOOD, New Jersey
RMC SALES DIVISION
Hewlett-Packard Company
391 Grand Ave.
Tel: (201) 567-3933

HARRISBURG, Pennsylvania
ROBINSON SALES DIVISION
Hewlett-Packard Company
Park Place Office Bldg.
Camp Hill, Penna.
Tel: (717) 737-6791

*HARTFORD, Connecticut
YEWELL ASSOCIATES, INC.
589 Saybrook Road
Middletown, Conn.
Tel: (203) 346-6611
TWX: 203-346-7433

*HIGH POINT, North Carolina
BIVINS & CALDWELL, INC.
1923 North Main St.
Tel: (919) 882-6873
TWX: 919-883-4912

*HOUSTON, Texas
EARL LIPSCOMB ASSOCIATES
3825 Richmond Ave.
Tel: (713) 667-2407
TWX: 713-571-1353

HUNTSVILLE, Alabama
BIVINS & CALDWELL, INC.
Tel: (205) 534-5733
(Direct line to Atlanta)

*INDIANAPOLIS, Indiana
CROSSLEY ASSOCIATES, INC.
3919 Meadows Drive
Tel: (317) 546-4891
TWX: 317-635-4300

LAS CRUCES, New Mexico
NEELY ENTERPRISES
114 South Water St.
Tel: (505) 526-2486
TWX: 505-524-2671

*LOS ANGELES, California
NEELY ENTERPRISES
3939 Lankershim Blvd.
North Hollywood, Cal.
Tel: (213) 877-1282
TWX: 213-769-4660

*MONTREAL, P.Q., Canada
HEWLETT-PACKARD (CANADA) LTD.
8270 Mayrand St.
Tel: (514) 735-2273

*NEW YORK, New York
RMC SALES DIVISION
Hewlett-Packard Company
236 East 75th St.
Tel: (212) 879-2023
TWX: 212-867-7136

ORLANDO, Florida
BCS ASSOCIATES, INC.
601 N. Fern Creek Ave.
Tel: (305) 241-1091
TWX: 305-275-0422

OTTAWA, Ontario, Canada
HEWLETT-PACKARD (CANADA) LTD.
1762 Carling Ave.
Tel: (613) 722-8162

*PHILADELPHIA, Pennsylvania
ROBINSON SALES DIVISION
Hewlett-Packard Company
144 Elizabeth St.
W. Conshohocken, Penna.
Tel: (215) 248-1600
TWX: 215-828-3847

*PHOENIX, Arizona
NEELY ENTERPRISES
771 S. Scottsdale Rd.
Scottsdale, Ariz.
Tel: (602) 945-7601
TWX: 602-949-0111

*PITTSBURGH, Pennsylvania
S. STERLING COMPANY
4232 Brownsville Rd.
Tel: (412) 884-5515

PORTLAND, Oregon
ARVA, INC.
2035 S.W. 58th Ave.
Tel: (503) 222-7337

RICHMOND, Virginia
BIVINS & CALDWELL, INC.
1219 High Point Ave.
Tel: (703) 355-7931
TWX: 703-359-5650

ROCHESTER, New York
SYRACUSE SALES DIVISION
Hewlett-Packard Company
800 Linden Ave.
Tel: (716) 381-4120

*SACRAMENTO, California
NEELY ENTERPRISES
1317 15th St.
Tel: (916) 442-8901
TWX: 916-444-8683

SALT LAKE CITY, Utah
LAHANA & COMPANY
1482 Major St.
Tel: (801) 486-8166
TWX: 801-521-2604

*SAN DIEGO, California
NEELY ENTERPRISES
1055 Shafter St.
Tel: (714) 223-8103
TWX: 714-276-4263

*SAN FRANCISCO, California
NEELY ENTERPRISES
501 Laurel St.
San Carlos, Cal.
Tel: (415) 591-7661
TWX: 415-594-8857

*SEATTLE, Washington
ARVA, INC.
1320 Prospect St.
Tel: (206) 622-0177
TWX: 206-998-0733

SPOKANE, Washington
ARVA, INC.
East 127 Augusta Ave.
Tel: (509) 325-2557

*ST. PAUL, Minnesota
CROSSLEY ASSOCIATES, INC.
842 Raymond Ave.
Tel: (612) 646-7881
TWX: 612-551-0055

SYRACUSE, New York
SYRACUSE SALES DIVISION
Hewlett-Packard Company
Packard Bldg., E. Malloy Rd.
Tel: (315) 454-2486

TORONTO, Ontario, Canada
HEWLETT-PACKARD (CANADA) LTD.
1415 Lawrence Ave. W.
Tel: (416) 249-9196

TUCSON, Arizona
NEELY ENTERPRISES
232 S. Tucson Blvd.
Tel: (602) 623-2564
TWX: 602-792-2759

*WASHINGTON, D.C.
HORMAN ASSOCIATES, INC.
941 Rollins Ave.
Rockville, Maryland
Tel: (301) 427-7560
TWX: 301-427-4651

*Indicates Instrument Repair Stations

†For instrument repair contact: Customer Service, Hewlett-Packard Company, 395 Page Mill Rd., Palo Alto, California, Tel: (415) 326-1755

BOONTON RADIO COMPANY