

THE OSCILLOGRAPHER

Vol. 13, No. 2

APRIL - JUNE, 1952

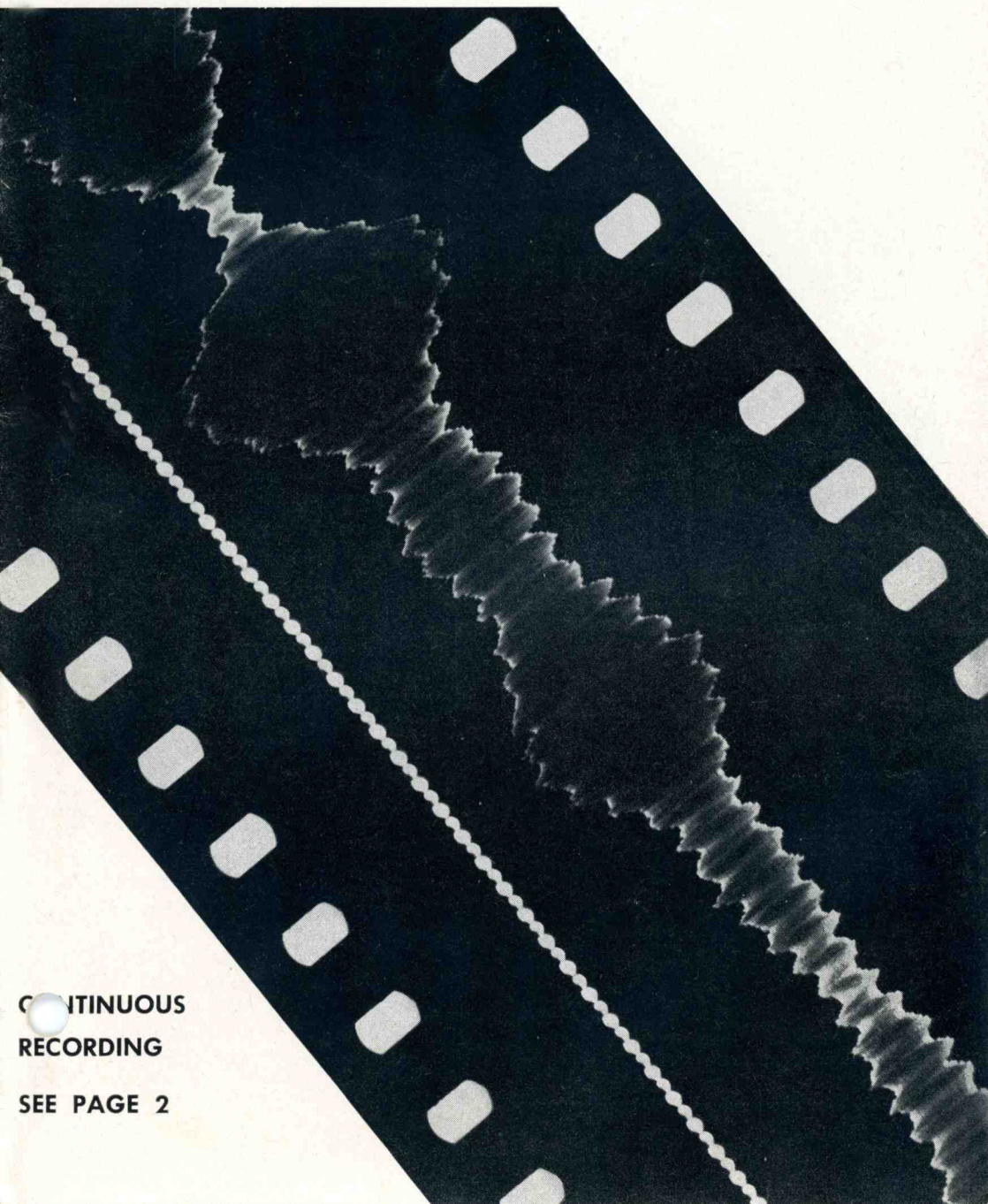

**CONTINUOUS
RECORDING**

SEE PAGE 2

Dr. Du Mont Honored by France

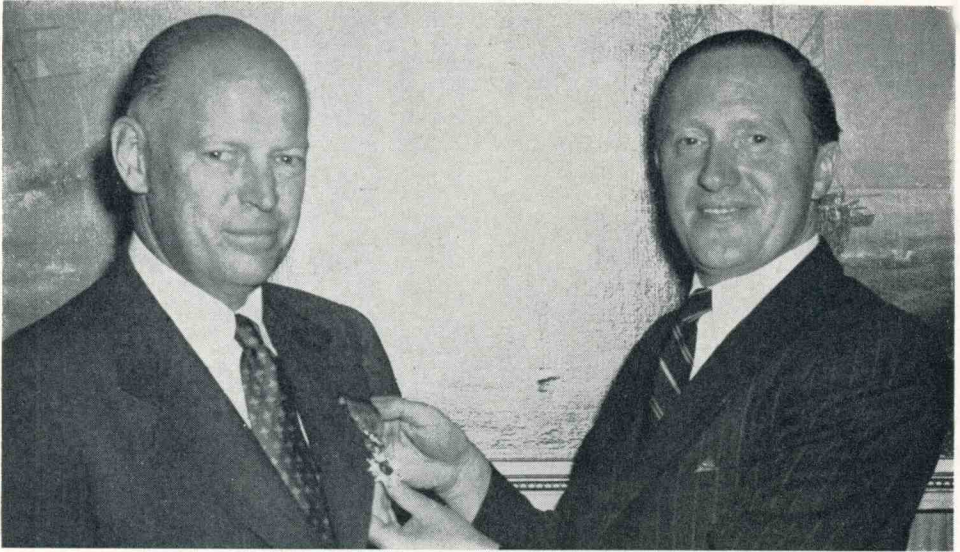

THE OSCILLOGRAPHER

A publication devoted exclusively to the cathode-ray oscillograph, providing the latest information on developments in equipment, applications, and techniques. Permission for reprinting any material contained herein may be obtained by writing to the Editor at address below.

Published quarterly & Copyright 1952
by

Allen B. Du Mont Laboratories, Inc.
Instrument Division
1500 Main Ave.
Clifton, N. J.

Neil Uptegrove - Editor

PRINTED
U.S.A.

ON THE COVER

This interesting pattern is an acoustic recording taken with a new Du Mont Type 321 Continuous-recording Camera from the face of a Du Mont Type 304-H Cathode-ray Oscillograph. Shown with the audio frequency note is a train of timing light markers whose frequency is 60 cycles per second. The new Type 321 is designed to work with any standard 5-inch oscillograph, to record repeating signals or drifting or transient patterns.

Dr. Allen B. Du Mont, president of the Allen B. Du Mont Laboratories, Inc., was recently made a chevalier in the French Legion of Honor for outstanding service rendered to the Allied cause during World War II through his scientific work and for his contributions to commercial relations between the United States and France. Shown conferring the honor is Jean de Lagarde (right), French consul-general in New York City. The presentation was made at a luncheon in the Union League Club, New York City.

TABLE OF CONTENTS

	Page
Dr. Du Mont Made Chevalier in Legion of Honor	2
Techniques of Measurement in Oscillography	3
The Du Mont Type 322 — A new Dual-beam, General-purpose Oscillograph	10

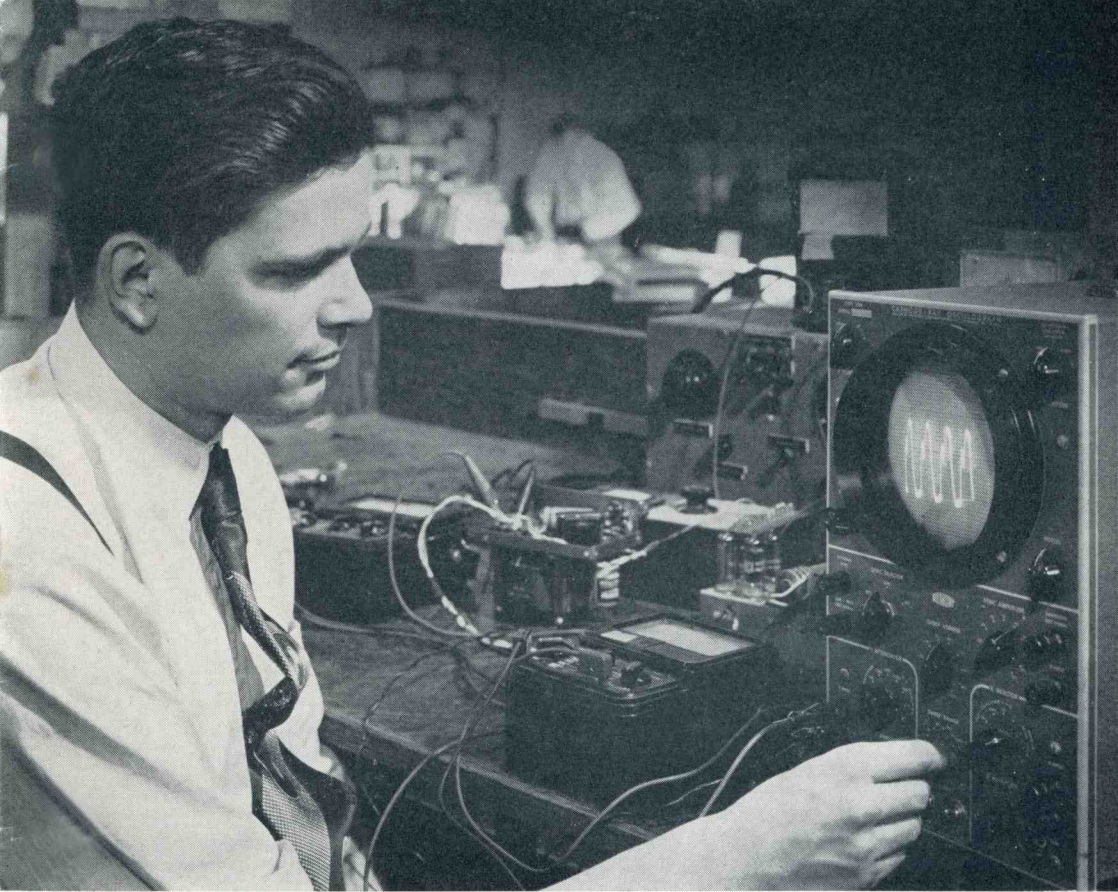

Techniques of Measurement in Oscillography

Part 2

By Dr. P. S. Christaldi

(Editor's note: Part 1 of "Techniques of Measurement in Oscillography" appeared in the preceding issue of the Oscillographer, Jan.-March, 1952, Vol. 13, No. 1. In Part 2, which follows, Dr. Christaldi concludes his discussion with observations on the measurement and interpretation of the pattern, calibration, etc.)

OBSERVATION AND MEASUREMENT OF PATTERN

Considerable freedom in the use of oscillographic equipment is left in the hands of the operator. Because of the wide variety of signal waveforms, it has always been considered desirable to provide as many operating controls as feasible. While this offers many advantages to the oper-

ator, it is also true that an unskilled or unthinking operator can lose much of the effectiveness of his equipment if he is not sufficiently acquainted with the equipment and its performance to use the best combination of settings. In addition, he must exercise the same degree of care in making readings as he would with any other type of measuring instrument.

For example, the resolution which can be obtained with a given instrument is not entirely fixed. Relatively little can be done to improve the spot size without sacrifice of brightness or persistence. However, more information concerning a waveform than perhaps was first thought possible can be obtained if a suitable

choice of sweep speeds is employed. This may also involve the use of delayed and expanded sweeps, with which it may be possible to improve the effective resolution by a factor of 100 or 1000. Similar results can be obtained with the amplitude of the signal, using amplitude selection devices in the form of suitably biased clippers or limiters at the input terminals, or between stages of the amplifier. The previously described method for studying corona impulses, where a relatively small impulse exists on a relatively large 60-cycle sinewave, illustrates the use of a high-pass filter to minimize the indicated amplitude of the 60-cycle wave, while the relatively high-frequency components of the impulse are transmitted with little or no attenuation.

Improvements in accuracy of reading can also be made by applying improved techniques in making the observation. The reduction of parallax by care in location of the observer's eye, using a fixed location for successive measurements, is helpful. Optical superposition of the scale on the oscillogram may be employed to minimize parallax. Photography provides another means for accomplishing this, since the location of the camera ordinarily is fixed with respect to the face of the cathode-ray tube, therefore providing successive records taken from the same point of view.

The effect of spot size and shape on the measurement should not be overlooked. They may vary widely in a given setup, depending upon settings of controls and characteristics of the signal. Spurious signals, such as those from radio-frequency carriers, or spurious magnetic deflection of the beam, may mask the desired effect and increase the effective spot size.

Where measurements of relative amplitude are to be made on different parts of a signal waveform, it is all too frequently assumed that the amplifier is perfectly linear in its response from the input terminals to final presentation on the face of the tube. Too often, unfortunately, this is not the case. Non-linear effects in the cathode-ray tube may amount to several percent, depending upon operating conditions, and usually become worse as the ra-

tio of intensifier to second-anode potentials is increased in high-voltage tubes. Nominally horizontal traces may be found to be not only off horizontal, depending upon the position of the trace, but also curved. Therefore, it is desirable, where extreme accuracies are sought, to calibrate the equipment over a wide range of trace positions. In extreme cases it might be desirable to make up a special calibrated scale utilizing exposures from the face of the cathode-ray tube produced by baselines that are displaced by amounts corresponding to the calibrating voltages.

Similar considerations apply with respect to sweep linearity, which is affected by the performance of the cathode-ray tube as well as by that of the sweep generator and any amplifiers that might be employed. Calibration of the sweep by means of suitable timing markers, applied either simultaneously with the signal or on a substitution basis, usually permits satisfactory results to be obtained. Here again, however, it might under some conditions be desirable to calibrate along the baseline for various positions of the baseline across the face of the tube.

Cross-coupling and other spurious responses sometimes cause trouble. In observing the rise time of a pulse, it might be found that negative time, or times shorter than seem reasonable, are indicated. One possible cause is coupling between the horizontal and vertical deflection circuits, taking place at almost any point along the amplifier chain. It can also occur even where signals are applied directly to the deflection plates, if the capacitances between the signal plate and each plate of the other deflection-plate pair are not equal.

Still another cause for such an apparent result is the departure of the deflection-plate structure from exact rectilinearity. Present manufacturing tolerances usually permit a deviation of deflections produced by the two pairs of plates up to plus or minus 3 degrees from orthogonality, although in practice this is usually held to considerably less. However, the tilt may be enough to cause a pulse rise time to be measured inaccurately, especially if the sweep speed is not sufficiently high to

Figure 1. By reducing the ambient light level greater contrast is obtained with the use of the Du Mont Type 276-A Viewing Hood

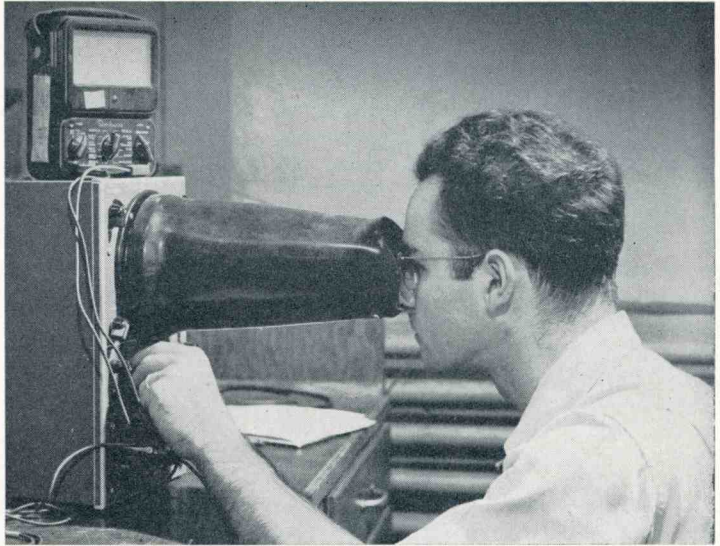

offset errors introduced by non-orthogonality of deflection.

Spurious responses from other causes have been mentioned previously, but it might be well to repeat that adequate electrostatic and magnetic shielding should be provided wherever difficulties are encountered, and that care should be exercised to avoid the presence of induced voltages in the signal leads themselves.

The effects of ambient light in reducing the usefulness of a display have already been mentioned, but it should be emphasized that in the study of short impulses of low repetition rate a considerable improvement usually can be obtained by adequate light shielding. The use of a good viewing hood, such as the type shown in Figure 1, as well as the avoidance of spurious illumination from the rear of the tube and the ventilating louvers, is frequently found to be equivalent to extra kilovolts of accelerating potential.

The stability of the pattern can have an important bearing on the amount of information presented as well as ease of interpretation. Pattern instability may be attributed to many causes, but the most common difficulties are those resulting from improper operation of the synchronizing or trigger controls and from poor power-line voltage regulation. Needless to say, in the case of instruments having d-c

amplifiers, sufficient warm-up time should be allowed for stabilization. This applies also to other circuits which may be temperature sensitive, such as those used in precise measurements of time. If observations are being made on a sequence of waveforms of varying amplitude, it is sometimes found that the synchronization of the sweep varies with the amplitude of the signal. In such cases it may be possible to synchronize or trigger the sweep from a steady external source, thereby providing a relatively stable sweep and avoiding the drift of the pattern or even complete loss of synchronization which may otherwise occur.

It was suggested previously that the use of photography is effective in reducing parallax. Other advantages may also be obtained. It is possible to enlarge the recorded oscillogram by projection, or to study fine detail using a magnifier. Such techniques frequently are employed where it is necessary to obtain data accurate to the order of one per cent. It is surprising to find how much information can be obtained from a suitably enlarged oscillogram, compared to what can be seen on the original negative or on the face of the tube itself.

No comments concerning the observation and measurement of oscillographic patterns would be complete without ad-

vocating the analysis of the techniques employed to determine whether other methods might provide better results. This is a step in the procedure which is all too frequently overlooked, the usual tendency being to judge the equipment incapable of providing the desired information if the first setup proves unsatisfactory. Such an attitude neglects the fact that very often it would be impracticable to design and build special equipment to make a particular measurement, while it might well be possible to use existing equipment by adopting improved techniques, or by making relatively minor modifications.

CALIBRATION OF THE CATHODE-RAY OSCILLOGRAPH

As with any other type of test equipment with which accurate measurements are to be made, calibration of the cathode-ray oscillograph is a vital part of the experimental procedure. The quantities for which calibration is necessary, as well as the techniques employed, will depend largely upon the particular problem at hand. The following discussion will suggest typical approaches.

Amplitude Calibration

Calibration of the signal amplitude usually is accomplished by means of the substitution method, in which a known and controlled voltage is substituted for the signal. It will be found convenient in most cases to adjust the gain of the signal channel to provide a suitably large deflection on the screen and a convenient scale factor. For example, a calibrating signal of one volt may be applied and the amplitude control adjusted to give a deflection of one inch. If the signal channel is perfectly linear, voltage readings can be scaled directly from the screen. When this procedure is followed, obviously the setting of the signal amplitude control must not be changed during the course of the measurements. However, stepped attenuators may be used, since they can be reset to the conditions under which calibration was made.

An alternative method is to substitute for the signal a calibrating voltage whose amplitude can be varied to equal that of

the unknown signal, the value of the calibrating voltage then being read from a meter or scale.

Simultaneous calibration of the amplitude of signals by introducing calibrating pulses or brightening dots directly on the signal is not too practical because of the complexity of the equipment required to accomplish it. However, it can well be considered in those cases where repeated measurements must be taken over a wide range of signal amplitudes.

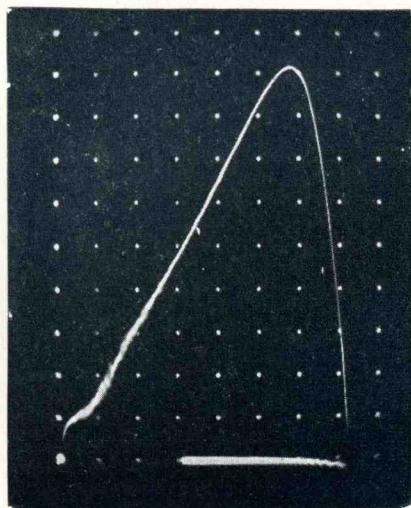

Figure 2. Matrix of dots for voltage calibration along X and Y axes

The type of calibrating signal is of considerable importance, since it influences the accuracy of measurement. In the case of oscillographs having d-c amplifiers, a stabilized source of potential such as a battery may be employed, with precision resistors used to provide a selection of voltages. If desired, a number of points on a divider can be connected consecutively through a rotating selector switch. A further refinement would be to provide a triggered sweep for each of the steps, resulting in a series of horizontal lines spaced in accordance with the calibrating voltages. Equipment has been built in which a grid pattern comprising a series of dots is employed to calibrate both vertical and horizontal amplitudes, as shown in Figure 2. This is achieved by connecting a series of controlled potentials to

the horizontal deflection channel through a rotating selector switch. At the end of each cycle a stepping switch shifts the vertical position of the spot.

The use of sinewaves for calibrating is common, but one of the principle objections to their use is the introduction of errors resulting from waveform distortion. A lesser objection is the difficulty of obtaining an accurate reading of the peaks of such a waveform. Also, the use of sinewaves suggests the possibility of employing the heater-voltage winding of the power transformer to provide the calibrating voltage. Obviously unless further steps are taken, this source will not be regulated. Therefore, it will be a satisfactory calibrating voltage source only if the line voltage is controlled, and if the waveform of the power line voltage is accurately maintained.

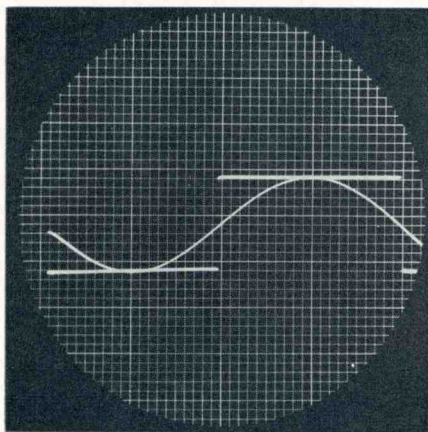

Figure 3. A 600-cycle sinewave and a 60-cycle square wave calibrating signal of equal amplitude shown superimposed for purposes of illustration. In actual practice the substitution method of calibration would be used if a dual-beam cathode-ray oscillograph were not employed

Square wave signals are perhaps most frequently used for calibrating because of the ease with which peak-to-peak readings can be made. (See Figure 3.) They also provide for calibrating different areas of the screen.

In the use of amplitude calibrators one must remember that attenuators should be considered as part of the signal chan-

nel. Normally, however, the attenuators can be expected to retain their calibration for long periods of time compared to amplifiers.

Time calibration of the sweep usually is considered more desirable than relying upon the calibration of controls. The chief reason for this is that the resistive and capacitive components used in generating the sawtooth sweep signals are more susceptible to change with age and temperature than the inductive components normally used in generating timing signals. Furthermore, it is usually more practicable for the manufacturer to compensate circuits used in time calibrating generating circuits to nearly the exact values desired than is the case of the components used in the sweep generating circuits.

Either simultaneous or substitution methods of calibration may be used. The simultaneous method is desirable, provided the timing marks are relatively short compared to the length of the sweep and, therefore, do not interfere seriously with interpretation of the signal waveform. It has the advantage of putting time calibrations along the sweep in exactly the positions on the screen occupied by the signal itself. This minimizes the effects of distortions. The substitution method, however, has the advantage of permitting study of the signal waveform free of extraneous marks.

The choice between intensity and deflection modulation of the trace is one which is not resolved easily, since it depends upon circumstances. Intensity modulation is to be preferred because it does not introduce what might be interpreted as differences in the waveform under study, while it has the disadvantage of introducing some loss of information during the time that the beam is blanked out. This could be avoided by brightening rather than blanking the beam, but in many cases the spot brightness is kept at maximum level and cannot be increased to mark time intervals.

The generation of very short, flat-topped impulses becomes exceedingly difficult as sweep speeds are increased. For example, if 10 markers are required on a

1-microsecond sweep, each marker must be spaced from the next by 0.1 microsecond. If these markers are to have mark-to-space ratios of the order of 1 to 10, the duration of the mark will be approximately 0.01 microsecond. For a rectangular pulse, signal frequency components will be of the order of 500 to 1000 megacycles. Signals such as these normally require low-impedance circuits, so that tremendous signal-current amplitudes must be available to provide the 100 to 200 volts necessary for beam blanking or deflection. Thus, providing markers of this nature is not only difficult but extremely expensive. For this reason it is expedient to use sinewave calibrating signals when the time intervals are relatively short. In addition to the elimination of the high-power circuits required to produce the necessary amplitudes, wave-shaping circuits are unnecessary.

Occasionally it may be desirable to use other means for introducing timing marks. One method is to apply known high-frequency signals to the grid of the cathode-ray tube in such a manner as to produce a series of dots. For relatively low-speed portions of the waveform, the dots will tend to blend into a continuous line, whereas during the high-speed intervals the spacing of the dots may be used to provide time information. Another possible method of application is second-anode potential modulation, the result being a change in deflection sensitivity at the rate of the calibrating signal. For the usual pulse signal waveforms the pattern is not difficult to interpret, and it avoids the difficulty sometimes encountered in attempting to add calibrating signals to beam-gate or other beam-control signals. Modulation of the first-anode voltage may also be used in some cases, although defocusing of the trace can result if the amplitudes are too large.

The application of high-frequency sine-wave or pulse-type timing markers through the signal channel is not always practicable because the frequency components of the timing markers may extend considerably beyond the band-pass of the signal channel. This is a factor in favor

of intensity modulation where simultaneous calibration is desired.

If calibrating signals keyed on synchronously with the beginning of the sweep are not available, it is possible to calibrate the sweep with a c-w signal. To accomplish this, merely connect the calibrating signal to the Y channel, or in any other suitable manner, and trigger the sweep once, recording photographically.

Calibration with respect to other quantities, such as rotation angle, pressure, etc., can be achieved using the principles just described. Because of their specialized nature they will not be considered here in detail.

Once the equipment has been calibrated, it is important that all of the conditions under which the calibration was made be maintained during the measurements. This includes the power-line voltage and the settings of controls. It is desirable to recheck the calibration at the end of the test run.

The size and shape of the spot may be important in determining the accuracies possible. One common difficulty is deciding which portion of the spot to use as the reference, the central portion usually being taken for this purpose. However, variations in spot size or shape across the screen may influence this choice.

Another consideration is the non-linear amplitude characteristics that the amplifier or sweep circuits may have, or that the fields of the cathode-ray tube may introduce. Here again, it is desirable to calibrate over the entire screen area, if this is feasible, and to utilize the calibration corresponding to the portion of the screen occupied by the signal waveform.

COMBINATION TECHNIQUES

In one frequently used technique moving film provides one component of the time-base on which a signal is displayed. Ionospheric recording, for example, uses a series of sweeps on which the height of the reflecting layer is displayed as intensity modulation. Film motion results in recording a series of such sweeps to provide a practically continuous trace in two

dimensions of the locations of the various layers as a function of time.

Another technique that has been employed is that of triggered gating of the beam. In some applications involving circular sweeps or Lissajous-type figures, it is convenient to have the beam gater on for a relatively short time, corresponding to single sweep techniques. This frequently is possible using the beam-gate circuits of oscillographs having single sweep features, with the sweep circuit itself disabled. In this manner it is possible, for example, to photograph a waveform corresponding to a single rotation of a shaft which is rotating continuously. All that is necessary is to adjust the length of the beam gate to correspond to one revolution of the shaft, and to trigger it in some appropriate manner.

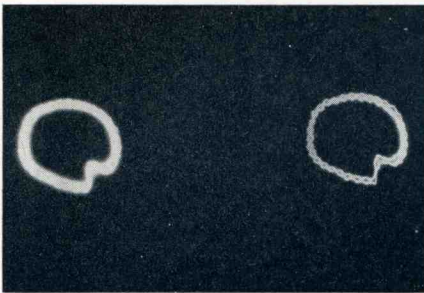

Figure 4. Integrated polar coordinate display of the averaged thread tension on a loom obtained by multiple exposures

Frequently, it is found that a waveform does not repeat itself exactly but with slight variations from cycle to cycle. In such cases averaging effects, produced either by screen persistence or by photographic recording, may be useful in providing a more representative result. (See Figure 4.) With careful consideration given to the characteristics of recording materials, this technique might also be applied for effectively determining distribution of energy or amplitude.

It should not be forgotten that multi-channel displays frequently can provide information in a form not otherwise obtainable, and electronic switching may sometimes be useful.

INTERPRETATION OF THE DISPLAY

Interpretation of the display really involves a review of all that has gone before. Frequently, it is found that reason, or perhaps intuition, tells us that the results that we observe cannot possibly represent the true state of affairs. In such cases we at once attempt to find out what accounts for the discrepancy. In any event, it is well to look with some skepticism upon the results to be sure they are valid. In order to avoid confusion, it is well to examine the calibrations employed to make certain that the scale factors are correct. The conditions of measurement should be checked to be sure that the oscillogram actually represents the phenomenon being studied. Sometimes it is found helpful to change some of the adjustments to see whether the results are related to variations of adjustments. If unexpected patterns are obtained, this might indicate stray signals or unwanted couplings, which should be eliminated.

It is well to examine a measuring technique rather thoroughly to ascertain whether the information desired was obtained in its complete form, or whether additional measurements or different test setups may be necessary. Often initial results suggest improvements or refinements in technique that would give the desired results with better accuracy or completeness.

The relationship of the oscillographic pattern to the phenomenon under study should be clear before the measurement is considered complete. Before breaking down the test setup, it is well to go over the results carefully. All too frequently time is lost setting up again to repeat measurements merely because initial perusal was not sufficiently detailed.

By and large, good oscillographic techniques boil down to careful analysis of the problem and methods to be used, understanding of the problem and of the equipment to be employed, systematic analysis of the results sought and the methods to be employed, and the continued application of ordinary common sense. Nothing should ever be taken for granted.

The Du Mont Type 322

A New Dual-beam, General-purpose, Oscilloscope

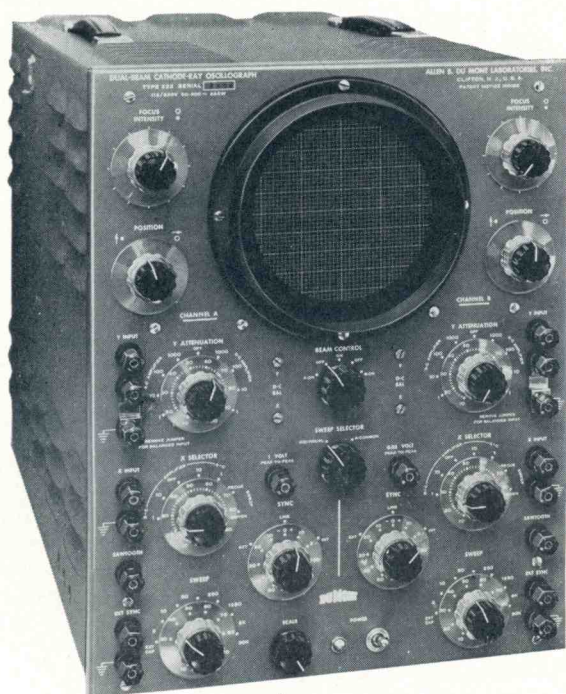

INTRODUCTION

The advantage of a dual-beam oscilloscope with two entirely independent channels have generally been recognized by those engaged in circuit analysis, development, etc. However, dual-beam oscilloscopes have not usually been considered for general applications because of their cost and size.

These objections have been eliminated in the compact Du Mont Type 322 Dual-beam Oscilloscope, placing the desirable features a highly versatile dual-beam oscilloscope well within the limits of the medium price range.

Frequency response of both vertical amplifiers is identical, and with direct

coupling, is flat at zero to 10% down at 100,000 cps. Capacitive coupling is also provided, and low-frequency response is down not more than 10% at 5 cps. The d-c response extends the range of application of the Type 322 to include extremely low-frequency phenomena—waveforms that would be distorted by conventional capacitive coupling. Also, it permits observation of a d-c level together with its a-c component. Thus, effects such as static and dynamic pressures, ignition and extinction potentials of gas tubes, chemical reactions which take several seconds or more, may be presented and analyzed. Vertical gain of both amplifiers is such that the majority of transducers may be used directly with

the Type 222 without preamplification.

Provision is included in both vertical channels for application of balanced signals at the 1 to 1 attenuation positions.

In order that full advantage may be taken of the d-c response of the vertical channel, sweeps of extremely long duration, up to 10 seconds or more, may be obtained by connecting an external capacitance at front panel terminals.

Individual time base generators are provided for the two channels. However, since a frequent application for a dual-beam oscillograph is the comparison of related wave forms, a common time base may be selected. Thus the need for pre-

cise synchronization of two time-base oscillators is eliminated. In order that the amplitude measurements may be made from the screen of the Type 322, a voltage calibrator is incorporated by means of which square wave voltage standards may be applied to the screen.

Additional features adding to the convenience of the Type 322 are: Z axis inputs which permit intensity modulation of each beam individually; also, an edge illuminated calibrated scale with dimming control which facilitates both visual comparison, and analysis from photographic recordings. A colored filter suitable for the screen type ordered is also included.

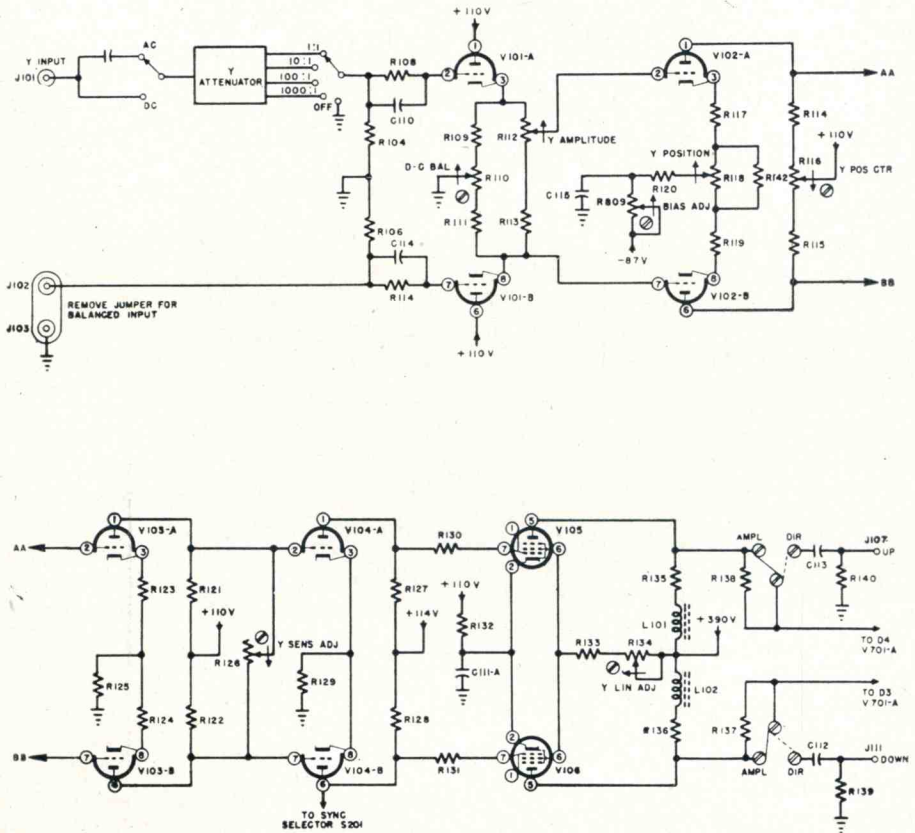

Figure 2. Y-axis amplifier circuit

CIRCUIT ANALYSIS

Vertical Axes

The vertical amplifiers for both channels are similar. Thus the discussion of the Channel A amplifier applies as well to that of Channel B.

The high-gain amplifier is preceded by an input attenuator and consists of an input cathode-follower stage, followed by a phase-inverting balanced amplifier, and three direct-coupled push-pull amplifier stages. The decade attenuator is R-C compensated to maintain frequency and phase response, and to present an impedance of 2.0 megohms in shunt with a maximum of 35 μf to the circuit under test, regardless of the attenuation selected.

Attenuation ratios of 1, 10, 100, and 1000 are available with both direct and capacitive input. With the Y attenuation in the "Off" position, the input signal is removed from the attenuator, and the grid of the cathode follower is grounded. Stage V101 (See Figure 2) is a cathode follower for the connection of single-ended signals, but functions essentially as a differential stage when used with balanced signals. The normally grounded grid (pin 7) of V101 is brought out to the front panel so that balanced-input operation may be obtained simply by removing a jumper on the front panel. The continuously variable AMPLITUDE control (R112) immediately follows V101. Resistor R113, in series with this control, prevents the operator from reducing the gain of the vertical amplifier to zero. Thus any signal having sufficient amplitude to saturate the input stage will cause greater than full-screen deflection, and it can be viewed only after setting the input attenuator control for greater attenuation. Resistors R108 and R114 in series with the grids of V101 guard input circuit from damage resulting from excessive input voltage. Shunting capacitors C110 and C114 provide frequency compensation.

Voltage at the ends of the amplitude control must be equal with no input signal applied. Otherwise vertical shifting of the trace would take place when the Y amplitude control was varied.

Equal voltage is obtained by adjusting the d-c balance adjustment (R110) which is conveniently located on the front panel.

The vertical deflection amplifier is composed of stages V102-V106 inclusive. The D-C Balanced circuit arrangement assures good deflection amplifier stability.

With the Y position control (R118) at its mechanical center, the Y position centering control is set so that the voltage drops across load resistors R114 and R115 are equal. Under this circumstance the undeflected trace will be at the vertical center of the cathode-ray tube. The positioning system provided is such that even with a vertical deflection equivalent to three times full screen diameter, any 5-inch position may be centered on the screen by the Y POSITION control. The Y sensitivity adjustment (R126) permits adjustment of the sensitive Y deflection amplifier to the specified 10 RMS microvolts per inch. This control provides a variable partial short between the plates of the second push-pull amplifier V103 and the input to the third push-pull amplifier V104.

Voltage for the screen grids of V105 and V106 in the final push-pull stage is obtained from an unregulated supply so that the sensitivity of the oscillograph will rise with increases in line voltage. Compensation is thus provided for changes in sensitivity of the cathode-ray tube as the acceleration potential varies with changes in line voltage. The back-of-panel Y linearity adjustment (R134) is a variable screen dropping resistor for the output tubes (V105, V106), thus controlling the linearity of the output signal.

Provision is made for direct input to the vertical deflection plates at side-panel terminals J107 and J111 through series input capacitors C112 and C113. The coupling capacitors are required since the deflection plates are maintained at approximately +200 volts with respect to ground to prevent beam distortion.

Sync and Sweep Circuits

The wide range of driven and recurrent sweeps is ample to cover the majority of general laboratory applications.

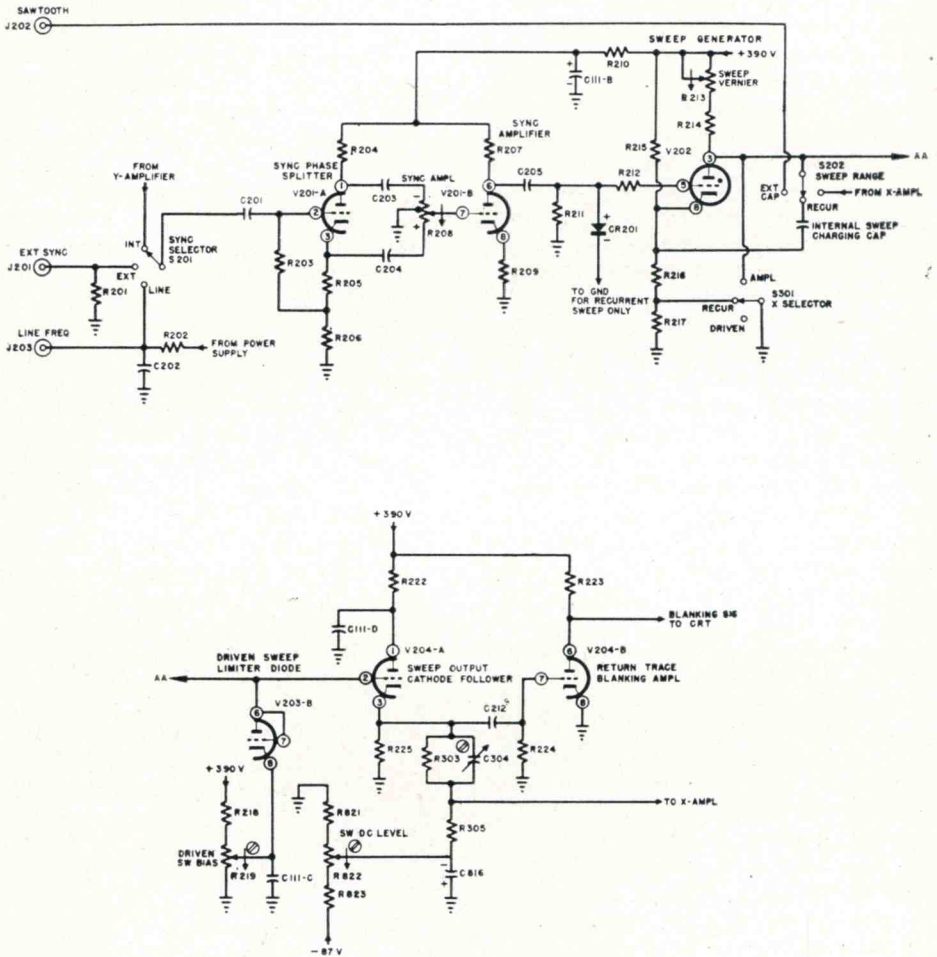

Figure 3. Sync and sweep circuits, simplified schematic

In order to study in detail high-frequency components of signals of lower-frequency, both driven and recurrent sweeps may be expanded up to 6 times full-screen diameter with horizontal positioning available over the entire range. Within the limits of the spot writing rate, up to 10 inches per microsecond, no distortions are introduced. The sync and sweep circuits of both channels are similar. A schematic of the Channel A sync and sweep circuits is shown in Figure 3. Provision is made for both driven and recurrent sweeps with expansion to six times full-screen diameter; the positioning range is sufficient to bring on screen any portion of the expanded sweep. The sweeps may be synchronized by signals of either positive or negative polarity. Similar time-base generators are incorporated in each channel. Moreover, by setting the SWEEP SELECTOR switch to "Common" the sweep of Channel A may be used to deflect both the beams of both channels simultaneously to provide a common time base.

Recurrent Sweep

Gas triode V202 in the simplified schematic of Figure 3 is employed to develop the sawtooth sweep voltage. The firing voltage of this tube is determined by the bias obtained from the voltage divider network consisting of R215 and R216. To facilitate circuit analysis only one sweep capacitor is shown in Figure 3, connected between the plate and cathode of the gas triode. This capacitor is charged from the +390-volt supply through the plate circuit resistors, R213 and R214, and the cathode bias resistor R216 until the plate voltage becomes sufficient for the gas triode to conduct. The sweep capacitor then discharges until the plate-to-cathode voltages falls to the extinction point (about 20 volts). V202 then no longer conducts and the changing cycle repeats to provide a sawtooth wave form. The sweep vernier control (R213) provides a fine adjustment of the time constant of the charging circuit, and hence of the frequency of the sawtooth sweep voltage.

The sawtooth sweep voltage across the

charging capacitor is coupled to the sweep-output cathode follower, V204-A. The output from this cathode follower is applied to a frequency-compensated voltage divider (R303, C304 and R305) which attenuates the sweep to approximately one-fifth of the original value. The lower end of the voltage divider is connected to an adjustable negative bias at the arm of the control (R822). When this back-of-panel adjustment is properly set, equal sweep-trace expansion from both sides of center screen will be obtained as the X AMPLITUDE control is advanced. The output from the voltage divider is coupled to the input of the X-axis amplifier when the X SELECTOR switch is set at the SWEEP position.

It is generally desirable to view only the forward portion of the sweep trace. This requires blanking of the return trace. To accomplish this, a negative pulse is generated at the end of the forward trace by the differentiating circuit composed of R224 and C212. This negative pip is applied to the grid of the return-trace blanking amplifier (V204-B). The resulting positive pulse at the plate of V204-B is coupled to the cathode of the cathode-ray tube to turn off the beam during the interval of the return trace.

Certain applications may require sweep frequencies lower than two cycles per second. For such applications a very low-frequency time base may be obtained by connecting an external capacitor between the SAWTOOTH front-panel terminal and ground when the SWEEP RANGE switch is set at EXT CAP. Approximately 0.5 second of sweep is obtained for each microfarad of capacitance so connected.

Driven Sweep

For operation in the driven-sweep mode, the gas triode (V202) will not "fire" except when triggered by a positive pulse applied to its grid. Each positive pulse of sufficient amplitude initiates a single cycle of sawtooth voltage. When the X SELECTOR switch is set at DRIVEN, the bias on the cathode of V202 is increased, owing to the addition of R217 in the voltage divider network. With this additional bias, a higher plate voltage must be applied to V202 before it

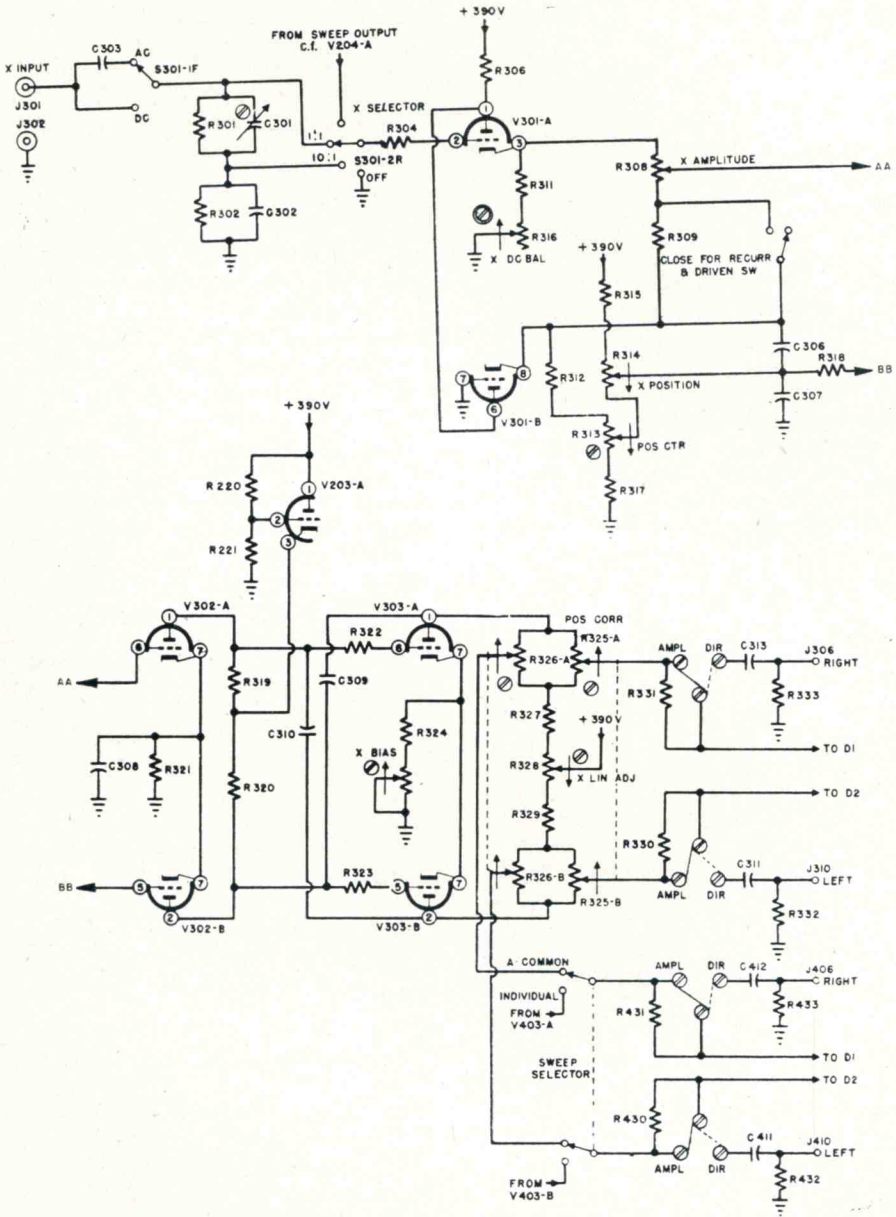

Figure 4. X-axis amplifier circuit, simplified schematic

"fires." The driven-sweep limiter diode (V203-B) prevents the plate of the gas triode from reaching the potential necessary for ionization under steady-state conditions. The functioning of this limiter is essentially as follows: The limiter, (V203-B) will conduct when the forward portion of the sawtooth waveform reaches a certain amplitude, as determined by the "Driven Sweep Bias" back-of-panel adjustment (R219) in the cathode circuit. Upon conduction, the voltage across the sweep charging capacitor is arrested at this point; and when R219 is properly set, the voltage is of insufficient magnitude to fire the gas triode (V202).

The driven sweep is initiated by applying a positive pulse of sufficient magnitude to the grid of V202. This enables the tube to "fire" at a plate potential lower than that established by the fixed bias on the cathode. The sweep capacitor quickly discharges through the ionized conduction path of V202 to the extinction potential. At this point, conduction no longer occurs, and the sweep capacitor again charges. The driven sweep cycle is complete when the sweep capacitor is again charged to the level established by the driven-sweep limiter diode (V203-B). The beam will sweep the screen again only upon application of another positive pulse to the grid of the gas triode.

Synchronization

The SYNC SELECTOR switch (S201) enables selection of the synchronizing signal: INTERNAL (signal obtained from the Y-axis Amplifier); LINE-frequency; or EXTERNAL (signal obtained from an external source). V201-A functions as a sync phase splitter. The SYNC AMPLITUDE control (R208) enables the operator to select the desired amplitude and polarity of the sync voltage. The output from the first sync amplifier (V201-B) is coupled to the grid of the sweep generator (V202) through C205 and R212. The anode of the germanium diode (CR201) is connected at the junction of R211 and R212; however, the cathode is connected to ground only when the X SELECTOR switch is set at RECURRENT SWEEP.

When thus connected in the circuit, this diode limits the sync voltage that can be applied to the sweep generator (V202) to prevent distortion of the sweep waveform which could result from over-sync. CR201 also prevents the grid-circuit capacitance of the sweep generator (V202) from charging to a positive potential at the higher sweep frequencies which would result in premature firing and erratic operation of V202. The useful sweep range is thus extended at the high-frequency end.

Horizontal Axes

The X-axis amplifiers are similar except for the inclusion of a position-correction circuit in the Channel A amplifier following the last push-pull stage. Each of the X-axis amplifiers is preceded by an input attenuator and consists of an input cathode follower, followed by two push-pull amplifier stages. A schematic of the X-axis amplifier is shown in Figure 4.

The X SELECTOR switch (S301) permits selection of internal or external signals for horizontal deflection. The internal signal is obtained from the linear time-base generator, previously discussed. Either d-c or a-c external signals may be applied through the X attenuator, which provides attenuation ratios of 1 or 10. At the OFF position, the grid of the input cathode follower (V301-A) is grounded.

V301-A and V301-B are connected in a cathode-follower circuit. No signal is applied to V301-B, its sole function being to maintain the grid (pin 5) of the phase inverting amplifier stage (V302) at signal ground potential while allowing d-c positioning voltage to be applied. The d-c balance adjustment (R316) is used to equalize the d-c voltage at the ends of the X AMPLITUDE control. When this adjustment is properly set, there will be no shifting (left or right) of the trace when moving X AMPLITUDE control from minimum to maximum with no input to the amplifier.

The over-all gain of the X amplifier is varied by the X AMPLITUDE control (R308). To prevent the operator from inadvertently overloading the input cath-

ode follower with resultant signal distortion, R309 is connected in series with the X AMPLITUDE control. The value chosen for R309 is such that with the X AMPLITUDE control set for minimum gain, a signal large enough to overload the input cathode follower (V301) will cause the beam to be deflected off the screen of the cathode-ray tube. A greater amount of attenuation must then be employed to bring the pattern on-screen. The range of the X AMPLITUDE control is such that a signal which causes five inches deflection of the electron beam on the screen at the maximum X AMPLITUDE control setting will be cut down to between 0.1 and 0.5 inch at the minimum setting.

The input cathode follower is designed so as to maintain the cathode (pin 8) of V301-B at a constant signal potential of zero volts with respect to ground.

When a positive-going signal is applied to the grid (pin 2) of V301-A, this tube will conduct more, causing more current through the series cathode network consisting of R308, R309, R312 and R317. The total current through the last three resistances is determined not only by the cathode current just mentioned but also in part by the current flowing through V301-B. The increased plate current of V301-A produces a voltage drop across R306 in the plate circuit, which lowers the plate voltage on V301-B, resulting in less plate current through the V301-A cathode network previously mentioned. Thus, the junction of R312 and R309 remains at the same (zero) potential. In practice, some small signal voltage may appear at this point; thus, C306 and C307 are provided as a capacitor voltage divider to provide high-frequency compensation.

V302 is connected in a conventional phase inverting amplifier circuit with the plate voltage supplied through the series dropping stage (V203-A) from the +390-volt supply. V203-A, in addition to providing the proper voltage drop, serves as a low-impedance path to ground through the power supply.

The output of the phase inverting amplifier is direct-coupled to a push-pull

output amplifier (V303). Plate voltage for this stage is obtained from the +390-volt supply through a linearity control, (R328, X LIN ADJ). This control is provided to compensate for any unbalance in the circuit caused by asymmetry of the two halves of the tube.

C309 and C310 provide sufficient feedback to reduce the input capacitance of V302, resulting in improvement of the high-frequency response of the amplifier.

Signals may be connected directly to the horizontal deflection plates in essentially the same manner as to the vertical deflection plates.

Power Supply

Channel A and B are each provided with their own low-voltage regulated (+110 volts) and unregulated (+390 volts) supplies. A common -87 volt regulated supply together with common high-voltage (-1400 volts and +1600 volts) supplies are also provided.

The low voltage positive supplies provide power for operating the X and Y-axis amplifiers, and the sync and sweep circuits. The common low-voltage negative supply furnishes the necessary bias for the SWEEP DC LEVEL controls (R822 and R825). The common high-voltage negative supply provides the necessary potentials at the various electrodes of the dual-beam cathode-ray tube and for the beam-control circuits. The high-voltage positive supply provides the necessary potential at the intensifier electrode of the cathode-ray tube.

Low-Voltage Power Supply

The low-voltage rectifiers (V802 and V808) are connected in full-wave rectifier circuits. The output from each is filtered by a capacitor-input type filter (C807, L801, and C806 for Channel A; C813, L802, and C811 for Channel B). The full-voltage output from the filter (+390 volts) is regulated by V802 and V810 to provide +110-volts regulated and is also reduced to +114 volts through V811-A and V811-B, which also provide regulation. The unregulated +390-volt output supplies the Y-amplifier output stages, sync, sweep, and

X-axis amplifier. In addition, this supply furnishes voltage to the second anode and intensifier electrodes of the dual-beam cathode-ray tube.

Each half of V811 is connected as a series regulator, the output of which is +114 volts for the Y-axis amplifier stages (V104 and V604) of the two respective channels.

V812 is connected as a half-wave rectifier from Terminal 13 of T801. Output from this rectifier is filtered by an R-C filter (R828, C809, R813 and C810). The output from this filter is -87 volts, regulated by V804. The NEGative REGulator current adjustment (R812) permits V804 to operate in the range from 1.5 to 3.5 ma d-c when line-voltage variations of as much as $\pm 10\%$ occur.

High-Voltage Power Supplies

V801 is connected in a half-wave rectifier circuit to supply the cathode potential of the cathode-ray tube. Its output is coupled to the sensitivity correction circuit described previously.

V809 is likewise connected as a half-wave rectifier, the output from which is filtered by R815, C812 and R816 a single-section in R-C circuit. Potential at the output of this filter is +1600 volts which provides the potential for the intensifier electrode of the cathode-ray tube.

Regulated Heater Supply

A regulated heater supply on the first and second stages of the Y-axis amplifier of both channels provides good vertical stability. A series-connected thermal regulator (V806 and V807) controls the heater temperature to stabilize cathode emission over a $\pm 10\%$ range of variation in supply voltage.

Voltage Calibrator

Calibrating square-wave potentials of 50 millivolts and 1 volt peak-to-peak, at powerline frequency, are provided at front-panel terminals. The X or Y-axis amplifiers of either channel may thus be calibrated readily by applying these signals to the proper input terminals.

Sixty-cycle voltage from Terminal 13 on T802 is applied to V805 through limiting resistor R827. R827 limits the current through V805 on conduction. With the plate (pin 2) tied to ground, any negative voltage impressed on the tube will cause it to conduct, thus flattening the voltage wave applied to the divider network (R805 through R808). Also, the calibrator clips any waveform in excess of 110 volts positive due to the application of the fixed, regulated, 110-volt potential to the cathode (pin 1). Thus, by connecting V805 in this manner, the peak amplitude of voltage across the voltage-divider network is established at 110 volts; and due to this clamping and clipping action, 60-cycle square waves are produced. R806 (VOLT CAL) is adjusted so that the voltages available at J802 and J803 are of proper amplitude.

In every respect, the Du Mont Type 322 DUAL-Beam Cathode-ray Oscillograph has been engineered to provide the broadest possible coverage of general laboratory applications. For general circuit development work, the dual-beam feature of the Du Mont Type 322 is invaluable. As is apparent in Figure 5, where two related waveforms from different portions of an experimental circuit are displayed on a common time base, the dual-channel display provides a convenience for close comparison which is in many instances essential.

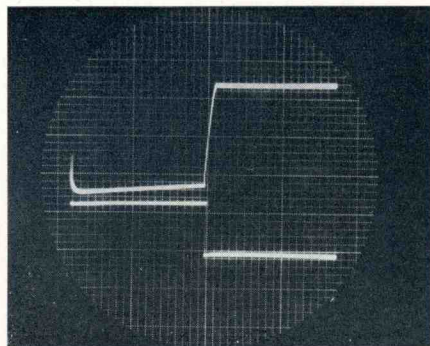

Figure 5. Input (lower trace) and output (upper trace) of an amplifier circuit using the common sweep of the new Type 322. The frequency is 1 KC. Note how the loss in rise time may be conveniently measured

Inclusion of direct-coupled signal amplifiers, aside from enabling the display of a d-c component makes possible the presentation of low-frequency signals without the distortion that would be introduced by the time constants of coupling circuits. Figure 6 shows the same low-frequency square-type wave applied to both channels. The upper waveform shows a-c coupling and the lower waveform, d-c coupling. Note the absence of tilt in the d-c presentation.

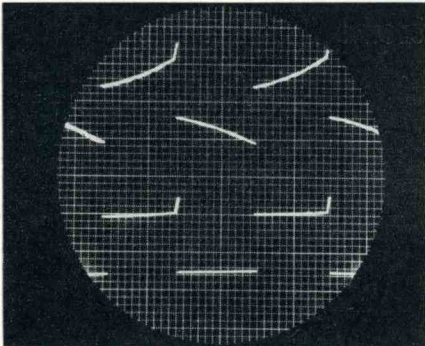

Figure 6. The same low-frequency square-type wave applied to both channels of the Type 322. Upper waveform shows a-c coupling and lower d-c coupling. Tilt in the tops of the upper waveform is caused by time constants in the a-c coupling circuit

Provision for balanced input in the Type 322 is valuable, particularly in instances where low-level signals are to be examined. Figure 7 shows a complex waveform from a balanced source displayed with balanced input (below). Note how the high amplitude of the high-frequency signal on both sides of the balanced output is cancelled with balanced input, but this same phenomenon renders the signal unusable with single-ended input.

The expandable sweeps of the Type 322 permit analysis of high-frequency components of low-frequency signals. Figure 8 shows the voltage field surrounding a fluorescent lamp. The signal is displayed without expansion on the upper trace, while a portion of the same signal expanded to examine the detail, is shown on the lower trace. Even with the sweep expanded to six times full-

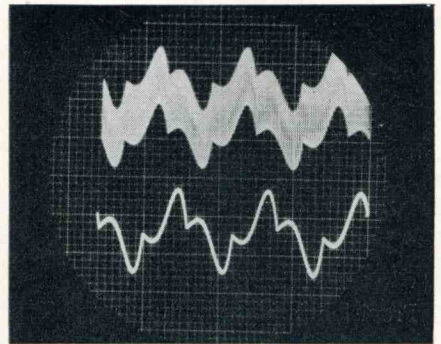

Figure 7. Complex waveform from a balanced output is displayed with balanced input (upper trace) and with single-ended input (lower trace)

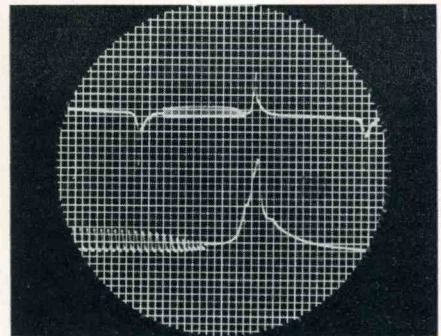

Figure 8. The field surrounding a fluorescent lamp is shown without expansion on the upper trace. A portion of the same signal is shown on the lower trace, expanded to resolve the detail

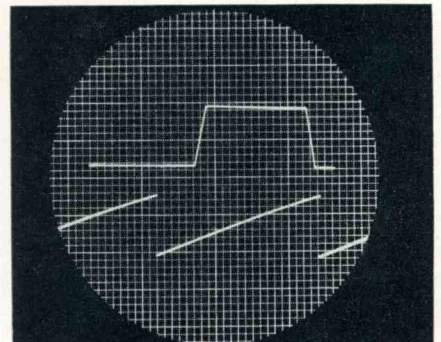

Figure 9. The 1-volt calibration standard, a clipped sinewave, is shown with a sawtooth waveform which has been set at a 1-volt peak amplitude externally by using the scale calibration.

screen diameter, any portion of the trace may be brought on to the screen and displayed without introduction of distortion.

To extend the utility of the Type 322 as a general-purpose oscillograph, regular calibrating potentials are provided at front-panel binding posts. The horizontal or vertical amplifiers of either channel may be calibrated simply by applying these potentials to the proper input (See Figure 9).

Provision is incorporated in the Type

322 to modulate intensity of either beam independently. In Figure 10, synchronizing pulses are displayed on the lower waveform. A single pulse expanded and displayed with timing markers impressed through the Z axis, is presented simultaneously for measurement.

Additional information on the new Du Mont Type 322 Dual-beam Cathode-ray Oscillograph may be obtained by writing the Instrument Division at the address given on Page 2.

Specifications

Cathode-ray Tube: Type 5SP-Dual-beam Cathode-ray Tube. Accelerating potential, 3000 volts overall.

Vertical Deflection — Deflection factor amplifiers (full gain), 0.028 p-p (0.01 rms), a-c or d-c coupling; direct 55-84 p-p v/in. **Input impedance:** to amplifiers, 2 megohms paralleled by 50 μf ; direct (balanced), 3 megohms paralleled by 20 μf ; direct (unbalanced), 1.5 megohms paralleled by 20 μf .

Sinusoidal frequency response of amplifiers (any setting of attenuator and gain controls): direct coupling, down not more than 10% at 100,000 cycles per second; capacitive coupling, down not more than 10% at 5 and 100,000 cycles per second; down not more than 50% at 300,000 cycles per second either input. **Maximum allowable input potential (single-ended)**, a-c coupling, 1000 volts d-c plus peak a-c; d-c coupling, 1000 volts d-c plus peak a-c on all attenuation ranges except 1:1 where it is 100 volts d-c plus peak a-c; **d-c balanced input** (at 1:1 position of attenuator only), may be operated up to +20 volts above ground with $4\frac{1}{2}$ volts peak-to-peak between grids.

Horizontal Deflection — Deflection factor amplifiers (full gain) 0.3 p-p (0.1 rms) v/in; direct, 47-71 v/in. **Input impedance** to amplifiers, 2 megohms paralleled by 50 μf ; direct (balanced) 3 megohms paralleled by 20 μf ; direct (unbalanced) 1.5 megohms paralleled by 20 μf . **Sinusoidal frequency response: single-ended** (for any setting of attenuator and gain controls) direct coupling, down not more than 10% at 100,000 cycles per second; capacitive coupling, down not more than 10% at 5 and 100,000 cycles per second; down not more than 50% at 300,000 cycles per second.

Sinusoidal frequency response: common horizontal amplifier, within 10% from 0 to 70,000 cycles per second; within 50% from 0 to 200,000 cycles per second.

Linear Time Base: Recurrent and driven sweeps variable in frequency from 2 to 30,000 cycles per second. Provision incorporated for sweeps of lower frequency by attaching external capacitance to convenient terminals; 0.5 seconds of

sweep time is secured for each microfarad of external capacitance. Both driven and recurrent sweeps expandable up to 6 times full-screen diameter, with positioning available over entire range. Direction of sweep is from left to right. Return trace is automatically blanked. Sweep may be synchronized by signal of either polarity. Provision for sweep "A" to deflect both beams simultaneously and provide common time base for both channels. Built-in compensation to equalize both X-deflection factors and X-positions when operating with common sweep.

Intensity Modulation: Input impedance to external signals is 0.2 megohm, paralleled by 80 μf . A negative signal of 15 volts peak will blank beam at normal intensity settings. Separate Z-input terminal available for intensity modulation of each beam individually.

Beam Control Switch: A beam control switch has been provided on the front panel to turn the beams on or off independently or simultaneously.

Calibrator: Regulated potentials of 50 millivolts and 1 p-p volt squarewave at power-line frequency available at front-panel binding posts. Vertical or horizontal amplifiers are calibrated by applying these potentials to the amplifiers.

Maximum Photographic Writing Rates: (With Du Mont 35-mm. oscillograph-record cameras) Type 296, using f/2.8 lens, 0.8 inches/ μsec ; Types 321 and 295, using f/1.5 lens, 2.8 inches/ μsec .

Tube Complement: 17-12AU7; 4-6AQ5; 2-6Q5G; 2-OB2; 4-6J6; 2-5Y3GT; 2-2X2A; 1-6AL5; 1-5651; 1-6X4; plus 2 ballast regulator tubes.

Power Source: 115 or 230 volts, 50-400 cycles/sec. Power consumption, 225 watts. Fuse protection, 3 amperes (115 volts), $1\frac{1}{2}$ amperes (230 volts).

Physical Characteristics: Overall dimensions, height $15\frac{3}{4}$ ", width $12\frac{1}{2}$ ", depth $22\frac{7}{8}$ ", weight 75 lbs. Illuminated scale with dimmer control; suitable filter provided for screen type; concentric controls.