

# Oscilloscope HM303-6

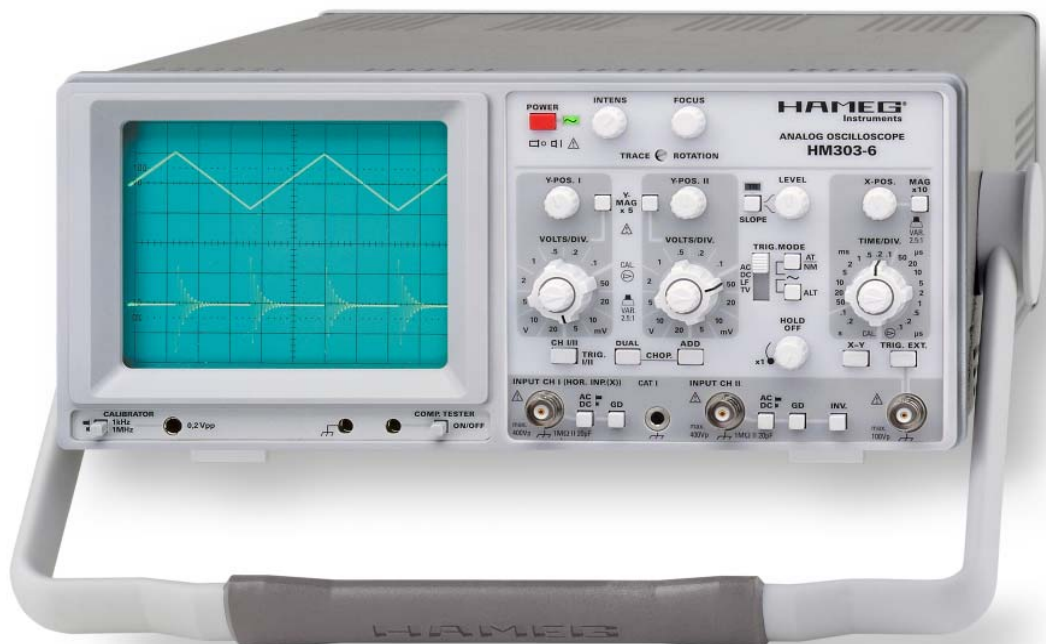

Manual

English



# Oscilloscope HM 303-6

<b>General information regarding the CE marking</b> .....	<b>3</b>		
<b>General Information</b> .....	<b>6</b>		
Symbols .....	6		
General Information .....	6		
Use of tilt handle .....	6		
Safety .....	6		
Intended purpose and operating conditions .....	6		
Warranty .....	7		
Maintenance .....	7		
Protective Switch-Off .....	7		
Power supply .....	7		
<b>Type of signal voltage</b> .....	<b>8</b>		
Amplitude Measurements .....	8		
Voltage values of a sine curve .....	8		
Total value of input voltage .....	9		
Time Measurements .....	9		
Connection of Test Signal .....	10		
<b>First Time Operation</b> .....	<b>11</b>		
Trace Rotation TR .....	11		
Probe compensation and use .....	11		
Adjustment at 1kHz .....	11		
Adjustment at 1MHz .....	12		
<b>Operating modes of the vertical amplifiers</b> .....	<b>12</b>		
X-Y Operation .....	13		
Phase comparison with Lissajous figures .....	13		
Phase difference measurement .....	13		
		in DUAL mode .....	13
		Phase difference measurement in DUAL mode .....	14
		Measurement of an amplitude modulation .....	14
		<b>Triggering and time base</b> .....	<b>14</b>
		Automatic Peak (value) - Triggering .....	15
		Normal Triggering .....	15
		Slope $\nearrow \searrow$ .....	15
		Trigger coupling .....	15
		Line triggering ( $\sim$ ) .....	16
		Alternate triggering .....	16
		External triggering .....	16
		Trigger indicator .....	16
		Holdoff-time adjustment .....	16
		<b>Component Tester</b> .....	<b>17</b>
		General .....	17
		Using the Component Tester .....	17
		Test Procedure .....	17
		Test Pattern Displays .....	17
		Testing Resistors .....	17
		Testing Capacitors and Inductors .....	17
		Testing Semiconductors .....	18
		Testing Diodes .....	18
		Testing Transistors .....	18
		In-Circuit Tests .....	18
		<b>Front Panel Elements HM 303-6 (Brief Description - Front View)</b> .....	<b>20</b>
		<b>Short Instruction for HM303-6</b> .....	<b>22</b>

		<b>KONFORMITÄTSERKLÄRUNG DECLARATION OF CONFORMITY DECLARATION DE CONFORMITE</b>		<b>HAMEG® Instruments</b>	
Hersteller Manufacturer Fabricant	HAMEG Instruments GmbH Industriestraße 6 D-63533 Mainhausen	Angewendete harmonisierte Normen / Harmonized standards applied / Normes harmonisées utilisées			
<b>Die HAMEG GmbH bescheinigt die Konformität für das Produkt The HAMEG GmbH herewith declares conformity of the product HAMEG GmbH déclare la conformité du produit</b>		<b>Sicherheit / Safety / Sécurité</b> EN 61010-1: 1993 / IEC (CEI) 1010-1: 1990 A 1: 1992 / VDE 0411: 1994 EN 61010-1/A2: 1995 / IEC 1010-1/A2: 1995 / VDE 0411 Teil 1/A1: 1996-05 Überspannungskategorie / Overvoltage category / Catégorie de surtension: II Verschmutzungsgrad / Degree of pollution / Degré de pollution: 2			
<b>Bezeichnung / Product name / Designation:</b> Oszilloskop/Oscilloscope/Oscilloscope		Elektromagnetische Verträglichkeit / Electromagnetic compatibility / Compatibilité électromagnétique			
Typ / Type / Type:	HM303-6	EN 61326-1/A1 Störaussendung / Radiation / Emission: Tabelle / table / tableau 4; Klasse / Class / Classe B. Störfestigkeit / Immunity / Imunité: Tabelle / table / tableau A1.			
mit / with / avec:	—	EN 61000-3-2/A14 Oberschwingungsströme / Harmonic current emissions / Émissions de courant harmonique: Klasse / Class / Classe D.			
Optionen / Options / Options:	—	EN 61000-3-3 Spannungsschwankungen u. Flicker / Voltage fluctuations and flicker / Fluctuations de tension et du flicker.			
mit den folgenden Bestimmungen / with applicable regulations / avec les directives suivantes		Datum /Date /Date	Unterschrift / Signature / Signatur		
EMV Richtlinie 89/336/EWG ergänzt durch 91/263/EWG, 92/31/EWG EMC Directive 89/336/EEC amended by 91/263/EWG, 92/31/EEC Directive EMC 89/336/CEE amendée par 91/263/EWG, 92/31/CEE		15.01.2001			
Niederspannungsrichtlinie 73/23/EWG ergänzt durch 93/68/EWG Low-Voltage Equipment Directive 73/23/EEC amended by 93/68/EEC Directive des équipements basse tension 73/23/CEE amendée par 93/68/CEE		E. Baumgartner Technical Manager / Directeur Technique			

## General information regarding the CE marking

HAMEG instruments fulfill the regulations of the EMC directive. The conformity test made by HAMEG is based on the actual generic- and product standards. In cases where different limit values are applicable, HAMEG applies the severer standard. For emission the limits for residential, commercial and light industry are applied. Regarding the immunity (susceptibility) the limits for industrial environment have been used.

The measuring- and data lines of the instrument have much influence on emission and immunity and therefore on meeting the acceptance limits. For different applications the lines and/or cables used may be different. For measurement operation the following hints and conditions regarding emission and immunity should be observed:

### 1. Data cables

For the connection between instruments resp. their interfaces and external devices, (computer, printer etc.) sufficiently screened cables must be used. Without a special instruction in the manual for a reduced cable length, the maximum cable length of a dataline must be less than 3 meters and not be used outside buildings. If an interface has several connectors only one connector must have a connection to a cable.

Basically interconnections must have a double screening. For IEEE-bus purposes the double screened cables HZ72S and HZ72L from HAMEG are suitable.

### 2. Signal cables

Basically test leads for signal interconnection between test point and instrument should be as short as possible. Without instruction in the manual for a shorter length, signal lines must be less than 3 meters and not be used outside buildings.

Signal lines must be screened (coaxial cable - RG58/U). A proper ground connection is required. In combination with signal generators double screened cables (RG223/U, RG214/U) must be used.

### 3. Influence on measuring instruments.

Under the presence of strong high frequency electric or magnetic fields, even with careful setup of the measuring equipment an influence of such signals is unavoidable.

This will not cause damage or put the instrument out of operation. Small deviations of the measuring value (reading) exceeding the instruments specifications may result from such conditions in individual cases.

### 4. RF immunity of oscilloscopes.

#### 4.1 Electromagnetic RF field

The influence of electric and magnetic RF fields may become visible (e.g. RF superimposed), if the field intensity is high. In most cases the coupling into the oscilloscope takes place via the device under test, mains/line supply, test leads, control cables and/or radiation. The device under test as well as the oscilloscope may be effected by such fields.

Although the interior of the oscilloscope is screened by the cabinet, direct radiation can occur via the CRT gap. As the bandwidth of each amplifier stage is higher than the total -3dB bandwidth of the oscilloscope, the influence RF fields of even higher frequencies may be noticeable.

#### 4.2 Electrical fast transients / electrostatic discharge

Electrical fast transient signals (burst) may be coupled into the oscilloscope directly via the mains/line supply, or indirectly via test leads and/or control cables. Due to the high trigger and input sensitivity of the oscilloscopes, such normally high signals may effect the trigger unit and/or may become visible on the CRT, which is unavoidable. These effects can also be caused by direct or indirect electrostatic discharge.

## 35 MHz Analog Oscilloscope HM303-6



Maximum signal fidelity with minimum overshoot

No signal distortion  
resulting from overshoot

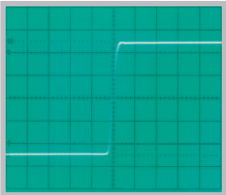

2 Channels with deflection coefficients of 1 mV – 20V/cm,  
Low Noise Amplifiers

Time Base 0.2 s – 100 ns/cm, with X Magnification to 10 ns/cm

Triggering from 0 to 50 MHz from 5 mm signal level  
(100 MHz > 8 mm)

Line triggered composite  
video signal

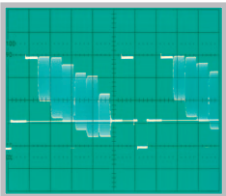

Analog mode provides unexcelled signal presentation at high  
resolution and up to 500,000 signal displays/sec.

Yt, XY and component-test modes

Full screen display of  
35 MHz sine wave signal

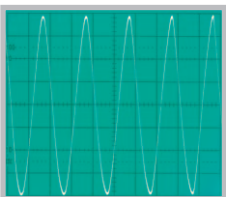

**35 MHz Analog Oscilloscope HM303-6**

Valid at 23 °C after a 30 minute warm-up period

**Vertical Deflection**

<b>Operating Modes:</b>	Channel I or II only Channels I and II (alternate or chopped) Sum or Difference of CH I and CH II
<b>Invert:</b>	CH II
<b>XY Mode:</b>	via CH I (X) and CH II (Y)
<b>Bandwidth:</b>	2 x 0 to 35 MHz (-3 dB)
<b>Rise Time:</b>	< 10 ns
<b>Overshoot:</b>	max. 1%
<b>Deflection Coefficients:</b>	1-2-5 Sequence
1 mV/div. – 2 mV/div.:	± 5% (Bandwidth 0 – 10 MHz (-3 dB))
5 mV/div. – 20 V/div.:	± 3% (Bandwidth 0 – 35 MHz (-3 dB))
Variable (uncalibrated):	> 2.5 : 1 to > 50 V/div.
<b>Input Impedance:</b>	1 MΩ    20 pF
<b>Input Coupling:</b>	DC, AC, GND (ground)
<b>Max. Input Voltage:</b>	400 V (DC + peak AC)

**Triggering**

<b>Automatic (Peak to Peak):</b>	20 Hz – 50 MHz (≥ 5 mm) 50 MHz – 100 MHz (≥ 8 mm)
<b>Normal with Level Control:</b>	0 – 50 MHz (≥ 5 mm) 50 MHz – 100 MHz (≥ 8 mm)
<b>Trigger Indicator:</b>	LED
<b>Slope:</b>	positive or negative
<b>Sources:</b>	Channel I or II, CH I / CH II alternate (≥ 8 mm), Line and External
<b>Coupling:</b>	<b>AC:</b> 10 Hz – 100 MHz <b>DC:</b> 0 – 100 MHz <b>LF:</b> 0 – 1.5 kHz
<b>Trigger Indicator:</b>	LED
<b>External Trigger Signal:</b>	≥ 0.3 V <sub>pp</sub> (30 Hz – 50 MHz)
<b>Active TV sync. separator:</b>	pos. and neg.

**Horizontal Deflection**

<b>Time Base:</b>	0.2 s/div. – 0.1 μs/div. (1-2-5 Sequence)
<b>Accuracy:</b>	± 3%
<b>Variabel (uncalibrated):</b>	> 2.5:1 to > 0.5 s/div.
<b>X Magnification x 10:</b>	up to 10 ns/div.
<b>Accuracy:</b>	± 5%
<b>Hold-Off Time:</b>	variable to approx. 10 : 1
<b>XY</b>	
<b>Bandwidth X Amplifier:</b>	0 – 2.5 MHz (-3 dB)
<b>XY Phase shift &lt; 3°:</b>	< 120 kHz

**Component Tester**

<b>Test Voltage:</b>	approx. 7 V <sub>rms</sub> (open circuit)
<b>Test Current:</b>	max. 7 mA <sub>rms</sub> (short-circuit)
<b>Test Frequency:</b>	approx. 50 Hz
<b>Test Connection:</b>	2 banana jacks 4 mm Ø

One test circuit lead is grounded via protective earth (PE)

**Miscellaneous**

<b>CRT:</b>	D14-363GY, 8 x 10 cm with internal graticule
<b>Acceleration Voltage:</b>	approx. 2 kV
<b>Trace Rotation:</b>	adjustable on front panel
<b>Calibrator Signal (Square Wave):</b>	0.2 V ± 1%, ≈ 1 kHz/1 MHz (tr < 4 ns)
<b>Power Supply (Mains):</b>	105 – 253 V, 50/60 Hz ± 10%, CAT II
<b>Power Consumption:</b>	approx. 36 Watt at 230 V/50 Hz
<b>Ambient temperature:</b>	0° C...+40° C
<b>Safety class:</b>	Safety class I (EN61010-1)
<b>Weight:</b>	approx. 5.4 kg
<b>Dimensions (W x H x D):</b>	285 x 125 x 380 mm

**Accessories supplied:** Line Cord, operator's manual, 2 Probes 1:1 / 10:1 (HZ154)

www.hameg.com

## General information

Please check the instrument for mechanical damage or loose parts immediately after unpacking. In case of damage we advise to contact the sender. Do not operate.

## List of symbols used



Consult the manual



High voltage



Important note



Ground

## Positioning the instrument

As can be seen from the figures, the handle can be set into different positions:

A = carrying

B = handle removal and horizontal carrying

C = horizontal operating

D and E = operating at different angles

F = handle removal

T = shipping (handle unlocked)



### Attention!

**When changing the handle position, the instrument must be placed so that it can not fall (e.g. placed on a table). Then the handle locking knobs must be simultaneously pulled outwards and rotated to the required position. Without pulling the locking knobs they will latch in into the next locking position.**

## Handle mounting/dismounting

The handle can be removed by pulling it out further, depending on the instrument model in position B or F.

## Safety

The instrument fulfils the VDE 0411 part 1 regulations for electrical measuring, control and laboratory instruments and was manufactured and tested accordingly. It left the factory in perfect safe condition. Hence it also corresponds to European Standard EN 61010-1 resp. International Standard IEC 1010-1. In order to maintain this condition and to ensure safe operation the user is required to observe the warnings and other directions for use in this manual. Housing, chassis as well as all measuring terminals are connected to safety ground of the mains. All accessible metal parts were tested against the mains with 200 V<sub>DC</sub>. The instrument conforms to safety class I.

The oscilloscope may only be operated from mains outlets with a safety ground connector. The plug has to be installed prior to connecting any signals. It is prohibited to separate the safety ground connection.

Most electron tubes generate X-rays; the ion dose rate of this instrument remains well below the 36 pA/kg permitted by law.

In case safe operation may not be guaranteed do not use the instrument any more and lock it away in a secure place.

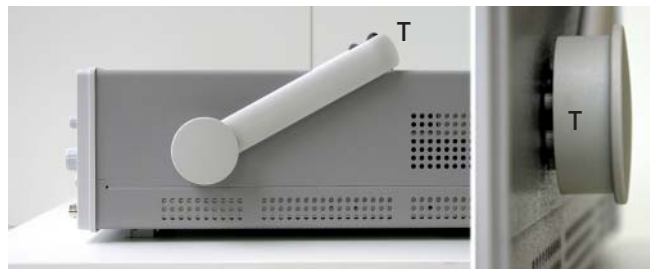
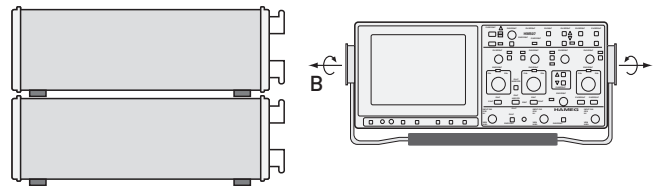
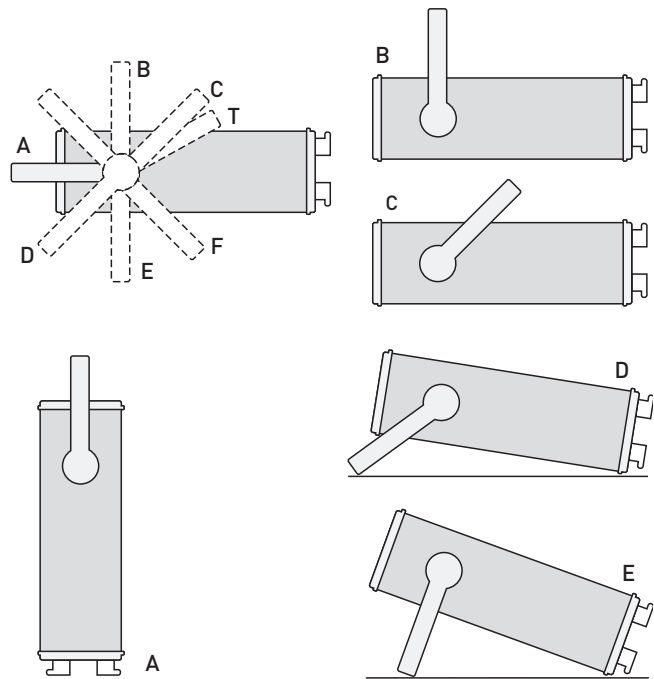

## Safe operation may be endangered if any of the following was noticed:

- in case of visible damage.
- in case loose parts were noticed
- if it does not function any more.
- after prolonged storage under unfavourable conditions (e.g. like in the open or in moist atmosphere).
- after any improper transport (e.g. insufficient packing not conforming to the minimum standards of post, rail or transport company)

## Proper operation

Please note: This instrument is only destined for use by personnel well instructed and familiar with the dangers of electrical measurements.

For safety reasons the oscilloscope may only be operated from mains outlets with safety ground connector. It is prohibited to separate the safety ground connection. The plug must be inserted prior to connecting any signals.

## CAT I

This oscilloscope is destined for measurements in circuits not connected to the mains or only indirectly. Direct measurements, i.e. with a galvanic connection to circuits corresponding to the categories II, III, or IV are prohibited!

The measuring circuits are considered not connected to the mains if a suitable isolation transformer fulfilling safety class II is used. Measurements on the mains are also possible if suitable probes like current probes are used which fulfil the safety class II. The measurement category of such probes must be checked and observed.

### Measurement categories

The measurement categories were derived corresponding to the distance from the power station and the transients to be expected hence. Transients are short, very fast voltage or current excursions which may be periodic or not.

Measurement CAT IV:

Measurements close to the power station, e.g. on electricity meters

Measurement CAT III:

Measurements in the interior of buildings (power distribution installations, mains outlets, motors which are permanently installed).

Measurement CAT II:

Measurements in circuits directly connected to the mains (household appliances, power tools etc).

### Environment of use.

The oscilloscope is destined for operation in industrial, business, manufacturing, and living sites.

### Environmental conditions

Operating ambient temperature: 0 to + 40 degrees C. During transport or storage the temperature may be -20 to +55 degrees C.

Please note that after exposure to such temperatures or in case of condensation proper time must be allowed until the instrument has reached the permissible range of 0 to + 40 degrees resp. until the condensation has evaporated before it may be turned on! Ordinarily this will be the case after 2 hours. The oscilloscope is destined for use in clean and dry environments. Do not operate in dusty or chemically aggressive atmosphere or if there is danger of explosion.

The operating position may be any, however, sufficient ventilation must be ensured (convection cooling). Prolonged operation requires the horizontal or inclined position.



**Do not obstruct the ventilation holes!**

Specifications are valid after a 20 minute warm-up period between 15 and 30 degr. C. Specifications without tolerances are average values.

### Warranty and repair

HAMEG instruments are subjected to a rigorous quality control. Prior to shipment each instrument will be burnt in for 10 hours. Intermittent operation will produce nearly all early failures. After

burn in, a final functional and quality test is performed to check all operating modes and fulfilment of specifications. The latter is performed with test equipment traceable to national measurement standards.

Statutory warranty regulations apply in the country where the HAMEG product was purchased. In case of complaints please contact the dealer who supplied your HAMEG product.

### Maintenance

Clean the outer shell using a dust brush in regular intervals. Dirt can be removed from housing, handle, all metal and plastic parts using a cloth moistened with water and 1 % detergent. Greasy dirt may be removed with benzene (petroleum ether) or alcohol, there after wipe the surfaces with a dry cloth. Plastic parts should be treated with an antistatic solution destined for such parts. No fluid may enter the instrument. Do not use other cleansing agents as they may adversely affect the plastic or lacquered surfaces.

### Line voltage

The instrument has a wide range power supply from 105 to 253 V, 50 or 60 Hz  $\pm 10\%$ . There is hence no line voltage selector.

The line fuse is accessible on the rear panel and part of the line input connector. Prior to exchanging a fuse the line cord must be pulled out. Exchange is only allowed if the fuse holder is undamaged, it can be taken out using a screwdriver put into the slot. The fuse can be pushed out of its holder and exchanged.

The holder with the new fuse can then be pushed back in place against the spring. It is prohibited to "repair" blown fuses or to bridge the fuse. Any damages incurred by such measures will void the warranty.

### Type of fuse:

Size 5 x 20 mm; 250V~, C;  
IEC 127, Bl. III; DIN 41 662  
(or DIN 41 571, Bl. 3).

Cut off: slow blow (T) 0,8A.

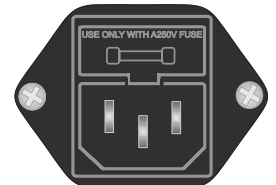

## Type of signal voltage

With the **HM303-6**, most repetitive signals in the frequency range up to **at least 35MHz** (-3dB) can be examined.

Sinewave signals of **50MHz** are displayed with a height of approx. 50% (-6dB). However when examining square or pulse type waveforms, attention must be paid to the **harmonic content** of such signals. The repetition frequency (fundamental frequency) of the signal must therefore be significantly smaller than the upper limit frequency of the vertical amplifier. Displaying composite signals can be difficult, especially if they contain no repetitive higher amplitude content which can be used for triggering. This is the case with bursts, for instance. To obtain a well-triggered display in this case, the assistance of the **variable holdoff** and/or **variable time control** may be required. Television **video signals** are relatively easy to trigger using the built-in **TV-Sync-Separator (TV)**. For optional operation as a DC or AC voltage amplifier, the vertical amplifier input is provided with a **DC/AC** switch. The **DC** position should only be used with a series-connected attenuator probe or at very low frequencies or if the measurement of the DC voltage content of the signal is absolutely necessary.

When displaying very low frequency pulses, the flat tops may be sloping with **AC** coupling of the vertical amplifier (**AC** limit frequency approx. 1.6 Hz for 3dB). In this case, **DC** operation is preferred, provided the signal voltage is not superimposed on a too high DC level. Otherwise a capacitor of adequate capacitance must be connected to the input of the vertical amplifier with DC coupling. This capacitor must have a sufficiently high breakdown voltage rating. **DC** coupling is also recommended for the display of logic and pulse signals, especially if the pulse duty factor changes constantly. Otherwise the display will move upwards or downwards at each change. Pure direct voltages can only be measured with **DC**-coupling.

## Amplitude Measurements

In general electrical engineering, alternating voltage data normally refers to effective values (rms = root-mean-square value). However, for signal magnitudes and voltage designations in oscilloscope measurements, the peak-to-peak voltage ( $V_{pp}$ ) value is applied. The latter corresponds to the real potential difference between the most positive and most negative points of a signal waveform.

If a sinusoidal waveform, displayed on the oscilloscope screen, is to be converted into an effective (rms) value, the resulting peak-to-peak value must be divided by  $2\sqrt{2} = 2.83$ . Conversely, it should be observed that sinusoidal voltages indicated in  $V_{rms}$  ( $V_{eff}$ ) have 2.83 times the potential difference in  $V_{pp}$ . The relationship between the different voltage magnitudes can be seen from the following figure.

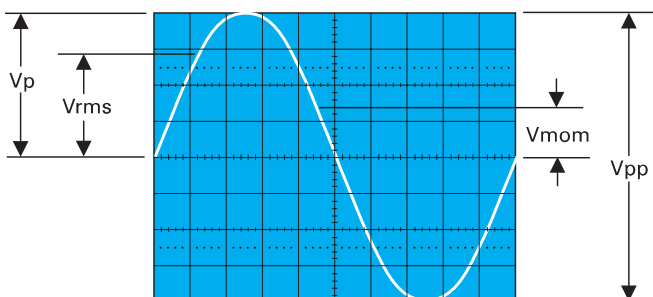

## Voltage values of a sine curve

$V_{rms}$  = effective value;  $V_p$  = simple peak or crest value;  
 $V_{pp}$  = peak-to-peak value;  $V_{mom}$  = momentary value.

The minimum signal voltage which must be applied to the Y input for a trace of 1 div. height is **1mVpp** when the **Y-MAG. x5** pushbutton is depressed, the **VOLTS/DIV.** switch is set to 5mV/div., and the vernier is set to **CAL** by turning the **fine adjustment knob** of the **VOLTS/DIV.** switch fully clockwise. However, smaller signals than this may also be displayed. The **deflection coefficients** on the input attenuators are indicated in **mV/div.** or **V/div.** (peak-to-peak value).

The magnitude of the applied voltage is ascertained by multiplying the selected deflection coefficient by the vertical display height in div.

If an attenuator probe x10 is used, a further multiplication by a factor of 10 is required to ascertain the correct voltage value.

For exact amplitude measurements, the variable control on the attenuator switch must be set to its calibrated detent **CAL**. When turning the variable control ccw, the sensitivity will be reduced by a factor of 2.5.

Therefore every intermediate value is possible within the 1-2-5 sequence.

With direct connection to the vertical input, signals **up to 400Vpp** may be displayed (attenuator set to **20V/div.**, variable control to left stop).

With the designations

**H** = display height in div.,  
**U** = signal voltage in Vpp at the vertical input,  
**D** = deflection coefficient in V/div. at attenuator switch,

the required value can be calculated from the two given quantities:

$$U = D \cdot H \quad H = \frac{U}{D} \quad D = \frac{U}{H}$$

However, these three values are not freely selectable. They have to be within the following limits (trigger threshold, accuracy of reading):

**H** between 0.5 and 8div., if possible 3.2 to 8div.,  
**U** between 0.5mVpp and 160Vpp,  
**D** between 1mV/div. and 20V/div. in 1-2-5 sequence.

### Examples:

Set deflection coefficient  $D = 50\text{mV/div.}$   $0.05\text{V/div.}$ ,  
 observed display height  $H = 4.6\text{div.}$ ,  
 required voltage  $U = 0.05 \cdot 4.6 = 0.23\text{Vpp}$ .

Input voltage  $U = 5\text{Vpp}$ ,  
 set deflection coefficient  $D = 1\text{V/div.}$ ,  
 required display height  $H = 5:1 = 5\text{div.}$

Signal voltage  $U = 230\text{Vrms} \cdot 2\sqrt{2} = 651\text{Vpp}$   
 (voltage > 160Vpp, with probe 10:1:  $U = 65.1\text{Vpp}$ ),  
 desired display height  $H = \text{min. } 3.2\text{div.}, \text{ max. } 8\text{div.}$ ,  
 max. deflection coefficient  $D = 65.1:3.2 = 20.3\text{V/div.}$ ,  
 min. deflection coefficient  $D = 65.1:8 = 8.1\text{V/div.}$ ,  
 adjusted deflection coefficient  $D = 10\text{V/div.}$

**The input voltage must not exceed 400V, independent from the polarity.** If an AC voltage which is superimposed on a DC voltage is applied, the maximum peak value of both voltages must not exceed + or -400V. So for AC voltages with a mean value of zero volt the maximum peak to peak value is 800Vpp. If attenuator probes with higher limits are used, the probes limits are valid only if the oscilloscope is set to DC input coupling.



If DC voltages are applied under AC input coupling conditions the oscilloscope maximum input voltage value remains 400V. The attenuator consists of a resistor in the probe and the 1MΩ input resistor of the oscilloscope, which are disabled by the AC input coupling capacity when AC coupling is selected. This also applies to DC voltages with superimposed AC voltages. It also must be noted that due to the capacitive resistance of the AC input coupling capacitor, the attenuation ratio depends on the signal frequency. For sinewave signals with frequencies higher than 40Hz this influence is negligible.

In the GD (ground coupling) setting, the signal path is interrupted directly beyond the input. This causes the attenuator to be disabled again, but now for both DC and AC voltages.

With the above listed exceptions **HAMEG** 10:1 probes can be used for DC measurements up to 600V or AC voltages (with a mean value of zero volt) of 1200Vpp. The 100:1 probe HZ53 allows for 1200V DC or 2400Vpp for AC.

It should be noted that its ACpeak value is derated at higher frequencies. If a normal x10 probe is used to measure high voltages there is the risk that the compensation trimmer bridging the attenuator series resistor will break down causing damage to the input of the oscilloscope. However, if for example only the residual ripple of a high voltage is to be displayed on the oscilloscope, a normal x10 probe is sufficient. In this case, an appropriate high voltage capacitor (approx. 22-68nF) must be connected in series with the input tip of the probe.

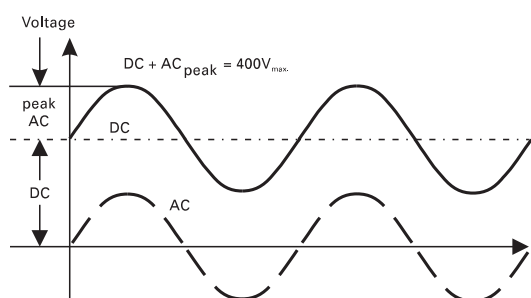

## Total value of input voltage

The dotted line shows a voltage alternating at zero volt level. If superimposed on a DC voltage, the addition of the positive peak and the DC voltage results in the max. voltage (DC + ACpeak).

With **Y-POS.** control (input coupling to **GD**) it is possible to use a horizontal graticule line as **reference line for ground potential** before the measurement. It can lie below or above the horizontal central line according to whether positive and/or negative deviations from the ground potential are to be measured.

## Time Measurements

As a rule, most signals to be displayed are periodically repeating processes, also called periods. The number of periods per second is the repetition frequency. Depending on the time base setting of the **TIME/DIV.** switch, one or several signal periods or only a part of a period can be displayed. The time coefficients are stated in **s/div.**, **ms/div.** and **μs/div.** on the **TIME/DIV.**-switch. The scale is accordingly divided into three fields.

The duration of a signal period or a part of it is determined by multiplying the relevant time (horizontal distance in div.) by the time coefficient set on the **TIME/DIV.**-switch.

**The variable time control (identified with an arrow knob cap) must be in its calibrated position CAL.** (arrow pointing horizontally to the right).

With the designations

**L** = displayed wave **length in div.** of one period,  
**T** = **time in seconds** for one period,  
**F** = recurrence **frequency in Hz** of the signal,  
**Tc** = **time coefficient in s/div.** on time base switch and the relation **F = 1/T**, the following equations can be stated:

$$T = L \cdot T_c \quad L = \frac{T}{T_c} \quad T_c = \frac{T}{L}$$

$$F = \frac{1}{L \cdot T_c} \quad L = \frac{1}{F \cdot T_c} \quad T_c = \frac{1}{L \cdot F}$$

With depressed X-MAG. (x10) pushbutton the Tc value must be divided by 10.

However, these four values are not freely selectable. They have to be within the following limits:

- L** between 0.2 and 10div., if possible 4 to 10div.,
- T** between 0.01μs and 2s,
- F** between 0.5Hz and 30MHz,
- Tc** between 0.1μs/div. and 0.2s/div. in 1-2-5 sequence (with **X-MAG. (x10)** in out position), and
- Tc** between 10ns/div. and 20ms/div. in 1-2-5 sequence (with pushed **X-MAG. (x10)** pushbutton).

### Examples:

Displayed wavelength  $L = 7 \text{ div.}$ ,  
 set time coefficient  $T_c = 0.1 \mu\text{s/div.}$ ,  
 required period  $T = 7 \times 0.1 \times 10^{-6} = 0.7 \mu\text{s}$   
 required rec. freq.  $F = 1:(0.7 \times 10^{-6}) = 1.428 \text{ MHz.}$

Signal period  $T = 1 \text{ s}$ ,  
 set time coefficient  $T_c = 0.2 \text{ s/div.}$ ,  
 required wavelength  $L = 1:0.2 = 5 \text{ div.}$

Displayed ripple wavelength  $L = 1 \text{ div.}$ ,  
 set time coefficient  $T_c = 10 \text{ ms/div.}$ ,  
 required ripple freq.  $F = 1:(1 \times 10 \times 10^{-3}) = 100 \text{ Hz.}$

TV-line frequency  $F = 15625 \text{ Hz}$ ,  
 set time coefficient  $T_c = 10 \mu\text{s/div.}$ ,  
 required wavelength  $L = 1:(15625 \times 10^{-5}) = 6.4 \text{ div.}$

Sine wavelength  $L = \text{min. } 4 \text{ div.}, \text{ max. } 10 \text{ div.}$ ,  
 Frequency  $F = 1 \text{ kHz}$ ,  
 max. time coefficient  $T_c = 1:(4 \times 10^3) = 0.25 \text{ ms/div.}$ ,  
 min. time coefficient  $T_c = 1:(10 \times 10^3) = 0.1 \text{ ms/div.}$ ,  
 set time coefficient  $T_c = 0.2 \text{ ms/div.}$ ,  
 required wavelength  $L = 1:(10^3 \times 0.2 \times 10^{-3}) = 5 \text{ div.}$

Displayed wavelength  $L = 0.8 \text{ div.}$ ,  
 set time coefficient  $T_c = 0.5 \mu\text{s/div.}$ ,  
 pressed X-MAG. (x10) button:  $T_c = 0.05 \mu\text{s/div.}$ ,  
 required rec. freq.  $F = 1:(0.8 \times 0.05 \times 10^{-6}) = 25 \text{ MHz}$ ,  
 required period  $T = 1:(25 \times 10^6) = 40 \text{ ns.}$

If the time is relatively short as compared with the complete signal period, an expanded time scale should always be applied (**X-MAG. x10** button pressed). In this case, the ascertained time values have to be divided by **10**. The time interval of interest can be shifted to the screen center using the **X-POS.** control.

## Type of signal voltage

When investigating pulse or square waveforms, the critical feature is the **risetime of the voltage step**. To ensure that transients, ramp-offs, and bandwidth limits do not unduly influence the measuring accuracy, the risetime is generally measured between **10%** and **90%** of the vertical pulse height. For measurement adjust the Y attenuator switch with its variable control together with the **Y-POS.** control so that the pulse height is precisely aligned with the 0% and 100% lines of the internal graticule. The 10% and 90% points of the signal will now coincide with the 10% and 90% graticule lines. **The risetime is given by the product of the horizontal distance in div. between these two coincidence points and the time coefficient setting.** If X x10 magnification is used, this product must be divided by 10. The **fall time** of a pulse can also be measured by using this method.

The following figure shows correct positioning of the oscilloscope trace for accurate risetime measurement.

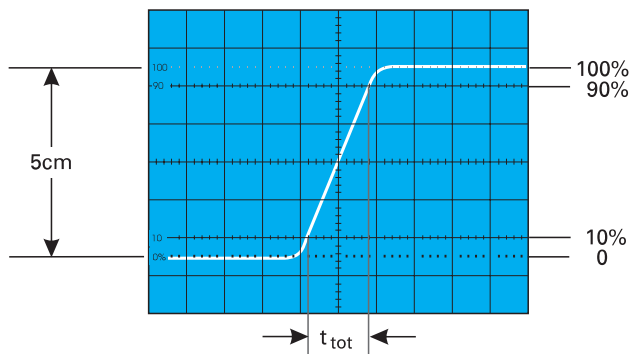

With a time coefficient of  $0.2\mu\text{s}/\text{div.}$  and pushed X-MAG x10 button the example shown in the above figure results in a measured total risetime of

$$t_{\text{tot}} = 1.6 \text{ div} \times 0.2\mu\text{s}/\text{div.} / 10 = \mathbf{32\text{ns}}$$

When very fast risetimes are being measured, the risetimes of the oscilloscope amplifier and of the attenuator probe has to be deducted from the measured time value. The risetime of the

$$t_r = \sqrt{t_{\text{tot}}^2 - t_{\text{osc}}^2 - t_p^2}$$

signal can be calculated using the following formula.

In this  $t_{\text{tot}}$  is the total measured risetime,  $t_{\text{osc}}$  is the risetime of the oscilloscope amplifier (approx. 10ns), and  $t_p$  the risetime of the probe (e.g. = 2ns). If  $t_{\text{tot}}$  is greater than 100ns, then  $t_{\text{tot}}$  can be taken as the risetime of the pulse, and calculation is unnecessary.

Calculation of the example in the figure above results in a signal risetime

$$t_r = \sqrt{32^2 - 10^2 - 2^2} = \mathbf{30,3\text{ns}}$$

The measurement of the rise or fall time is not limited to the trace dimensions shown in the above diagram. It is only particularly simple in this way. In principle it is possible to measure in any display position and at any signal amplitude. It is only important that the full height of the signal edge of interest is visible in its full length at not too great steepness and that the horizontal distance at 10% and 90% of the amplitude is measured. If the edge shows rounding or overshooting, the 100% should not be related to the peak values but to the mean pulse heights. Breaks or peaks (glitches) next to the edge are also not taken into account. With very severe transient distortions, the rise and fall time measurement has little meaning. For amplifiers with approximately constant group delay (therefore good pulse transmission performance) the following numerical relationship between rise time **tr (in ns)** and bandwidth **B (in MHz)** applies:

$$t_r = \frac{350}{B} \quad B = \frac{350}{t_r}$$

## Connection of Test Signal

### Caution:

**When connecting unknown signals to the oscilloscope input, always use automatic triggering and set the DC-AC input coupling switch to AC. The attenuator switch should initially be set to 20V/div.**

Sometimes the trace will disappear after an input signal has been applied. The attenuator switch must then be turned back to the left, until the vertical signal height is only 3-8div. With a signal amplitude greater than  $160V_{pp}$ , an attenuator probe must be inserted before the vertical input. If, after applying the signal, the trace is nearly blanked, the period of the signal is probably substantially longer than the set value on the **TIME/DIV.** switch. It should be turned to the left to an adequately larger time coefficient.

The signal to be displayed can be connected directly to the Y-input of the oscilloscope with a shielded test cable such as HZ 32 or HZ 34, or reduced through a x10 or x100 attenuator probe. The use of test cables with high impedance circuits is only recommended for relatively low frequencies (up to approx. 50kHz). For higher frequencies, the signal source must be of low impedance, i.e. matched to the characteristic resistance of the cable (as a rule  $50\Omega$ ). Especially when transmitting square and pulse signals, a resistor equal to the characteristic impedance of the cable must also be connected across the cable directly at the Y-input of the oscilloscope. When using a  $50\Omega$  cable such as the HZ 34, a  $50\Omega$  through termination type HZ22 is available from **HAMEG**.

When transmitting square signals with short rise times, transient phenomena on the edges and top of the signal may become visible if the correct termination is not used. A terminating resistance is sometimes recommended with sine signals as well. Certain amplifiers, generators or their attenuators maintain the nominal output voltage independent of frequency only if their connection cable is terminated with the prescribed resistance. Here it must be noted that the terminating resistor HZ22 will only dissipate a maximum of 2 Watts. This power is reached with  $10 V_{rms}$  or at  $28.3 V_{pp}$  with sine signal.

If a x10 or x100 attenuator probe is used, no termination is necessary. In this case, the connecting cable is matched directly to the high impedance input of the oscilloscope. When using attenuator probes, even high internal impedance sources are only slightly loaded (approx.  $10M\Omega \parallel 16\text{pF}$  or  $100M\Omega \parallel 9\text{pF}$  with HZ53). Therefore, if the voltage loss due to the attenuation of the probe can be compensated by a higher amplitude setting, the probe should always be used. The series impedance of the probe provides a certain amount of protection for the input of the vertical amplifier. Because of their separate manufacture, all attenuator probes are only partially compensated, therefore accurate compensation must be performed on the oscilloscope (see "Probe compensation").

Standard attenuator probes on the oscilloscope normally reduce its bandwidth and increase the rise time. In all cases where the oscilloscope bandwidth must be fully utilized (e.g. for pulses with steep edges) we strongly advise using the **probes HZ51 (x10) HZ52 (x10 HF) and HZ54 (x1 and x10)**. This can save the purchase of an oscilloscope with larger bandwidth and has the advantage that defective components can be ordered from **HAMEG** and replaced by oneself. The probes mentioned have a HF-calibration in addition to low frequency calibration adjustment. Thus a group delay correction to the

upper limit frequency of the oscilloscope is possible with the aid of an 1MHz calibrator, e.g. HZ60.

In fact the bandwidth and rise time of the oscilloscope are not noticeably changed with these probe types and the waveform reproduction fidelity can even be improved because the probe can be matched to the oscilloscopes individual pulse response.

**If a x10 or x100 attenuator probe is used, DC input coupling must always be used at voltages above 400V.**

With AC coupling of low frequency signals, the attenuation is no longer independent of frequency, pulses can show pulse tilts. Direct voltages are suppressed but load the oscilloscope input coupling capacitor concerned. Its voltage rating is max. 400V (DC + peak AC). **DC** input coupling is therefore of quite special importance with a x100 attenuation probe which usually has a voltage rating of max. 1200 V (DC + peak AC). A **capacitor** of corresponding capacitance and voltage rating may be connected in **series with the attenuator** probe input for blocking DC voltage (e.g. for hum voltage measurement).

With all attenuator probes, the **maximum AC input voltage** must be **derated** with frequency usually above 20kHz. Therefore the derating curve of the attenuator probe type concerned must be taken into account.

The selection of the ground point on the test object is important when displaying small signal voltages. It should always be as close as possible to the measuring point. If this is not done, serious signal distortion may result from spurious currents through the ground leads or chassis parts. The ground leads on attenuator probes are also particularly critical. They should be as short and thick as possible. When the attenuator probe is connected to a BNC-socket, a BNC-adaptor, which is often supplied as probe accessory, should be used. In this way ground and matching problems are eliminated.

Hum or interference appearing in the measuring circuit (especially when a small deflection coefficient is used) is possibly caused by multiple grounding because equalizing currents can flow in the shielding of the test cables (voltage drop between the protective conductor connections, caused by external equipment connected to the mains/line, e.g. signal generators with interference protection capacitors).

## First Time Operation

**Before applying power** to the oscilloscope it is recommended that the following simple procedures are performed:

- Check that all pushbuttons are in the **out** position, i.e. released.
- Rotate the variable controls with arrows, i.e. **TIME/DIV.** variable control, **CH I** and **CH II** attenuator variable controls, and **HOLDOFF** control to their calibrated detent.
- Set all controls with marker lines to their midrange position (marker lines pointing vertically).
- The **TRIG. MODE** selector switch should be set to the position uppermost (AC).
- Both **GD** input coupling pushbutton switches for **CH I** and **CH II** should be set to the **GD** position.

Switch on the oscilloscope by depressing the red **POWER** pushbutton. An LED will illuminate to indicate working order. The trace, displaying one baseline, should be visible after a short warm-up period of approx. 10 seconds. Adjust **Y-POS.I** and **X-POS.** controls to center the baseline. Adjust **INTENS** (intensity) and **FOCUS** controls for medium brightness and optimum sharpness of the trace. The oscilloscope is now ready for use.

If only a spot appears (**CAUTION!** CRT phosphor can be damaged), reduce the intensity immediately and check that the **XY** pushbutton is in the released (out) position. If the trace is not visible, check the correct positions of all knobs and switches (particularly **AT/NM** button in out position).

To obtain the maximum life from the cathode-ray tube, the minimum intensity setting necessary for the measurement in hand and the ambient light conditions should be used.

**Particular care is required when a single spot is displayed**, as a very high intensity setting may cause damage to the fluorescent screen of the CRT. Switching the oscilloscope off and on at short intervals stresses the cathode of the CRT and should therefore be avoided.

The instrument is so designed that even incorrect operation will not cause serious damage. The pushbuttons control only minor functions, and it is recommended that before commencement of operation all pushbuttons are in the "out" position. After this the pushbuttons can be operated depending upon the mode of operation required.

## Trace Rotation TR

In spite of Mumetal-shielding of the CRT, effects of the earth's magnetic field on the horizontal trace position cannot be completely avoided. This is dependent upon the orientation of the oscilloscope on the place of work. A centered trace may not align exactly with the horizontal center line of the graticule. A few degrees of misalignment can be corrected by a potentiometer accessible through an opening on the front panel marked **TRACE ROTATION**.

## Probe compensation and use

To display an undistorted waveform on an oscilloscope, the probe must be matched to the individual input impedance of the vertical amplifier.

For this purpose a square wave signal with a very fast rise time and minimum overshoot should be used, as the sinusoidal contents cover a wide frequency range. The frequency accuracy and the pulse duty factor are not of such importance.

The built-in calibration generator provides a square wave signal with a very fast risetime (<4ns), and switch-selectable frequencies of approx. 1kHz and 1MHz from the output socket below the CRT screen.

***This signal should not be used for frequency calibration!***

The output provides 0.2Vpp 1% (tr <4ns) for x10 probes. When the Y deflection coefficient is set to 5mV/div, the calibration voltage corresponds to a vertical display of 4 divisions (x10 probe).

The output sockets have an internal diameter of 4.9mm to accommodate the internationally accepted shielding tube diameter of modern Probes and F-series slimline probes. Only this type of construction ensures the extremely short ground connections which are essential for an undistorted waveform reproduction of non-sinusoidal high frequency signals.

## Adjustment at 1kHz

The C-trimmer adjustment (low frequency) compensates the capacitive loading on the oscilloscope input (approx. 20 pF for the HM303-6). By this adjustment, the capacitive division assumes the same ratio as the ohmic voltage divider to ensure the same division ratio for high and low frequencies,

# Operating modes of the vertical amplifiers

as for DC. (For x1 probes or switchable probes set to x1, this adjustment is neither required nor possible). A baseline exactly parallel to the horizontal graticule lines is a major condition for accurate probe adjustments. (See also "Trace rotation").

Connect the probes (Types **HZ51**, **52**, **54**, or **HZ36**) to the **CH I** input. All pushbuttons should be released (in the out position). Set input coupling to DC, the attenuator to 5 mV/div., and TIME/DIV. switch to 0.2 ms/div., and all variable controls to CAL. position. Plug the probe tip into the calibrator output socket.

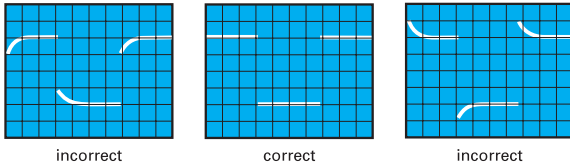

Approximately 2 complete waveform periods are displayed on the CRT screen. Now the compensation trimmer has to be adjusted. The location of the low frequency compensation trimmer can be found in the probe information sheet. Adjust the trimmer with the insulating screw driver provided until the tops of the square wave signal are exactly parallel to the horizontal graticule lines (see 1 kHz diagram). The signal height should then be 4 div. 0.16div. (= 4 % (oscilloscope 3% and probe 1%)). During this adjustment, the signal edges will remain invisible.

## Adjustment at 1MHz

Probes HZ51, 52 and 54 can also be HF-compensated. They incorporate resonance de-emphasizing networks (R-trimmer in conjunction with capacitors) which permit probe compensation in the range of the upper frequency limit of the vertical oscilloscope amplifier. Only this compensative adjustment ensures optimum utilisation of the full bandwidth, together with constant group delay at the high frequency end, thereby reducing characteristic transient distortion near the leading edge (e.g. overshoot, rounding, ringing, holes or bumps) to an absolute minimum.

Using the probes **HZ51**, **52** and **54**, the full bandwidth of the **HM303-6** can be utilized without risk of unwanted waveform distortion.

Prerequisite for this HF compensation is a square wave generator with fast risetime (typically 4 ns), and low output impedance (approx. 50Ω), providing 0.2V at a frequency of approx. 1MHz. The calibrator output of the HM303-6 meets these requirements when the CAL. pushbutton is depressed.

Connect the probe to **CHI** input. Depress the CAL. pushbutton for 1MHz. All other pushbuttons should be released (out position). Set the **CHI** input coupling to **DC**, attenuator switch to **5mV/div**, and **TIME/DIV.** switch to **0.2µs/div**. Set all variable controls to CAL. position.

Insert the probe tip into the output socket. A waveform will be displayed on the CRT screen, with leading and trailing edges clearly visible. For the HF-adjustment now to be performed, it will be necessary to observe the rising edge as well as the upper left corner of the pulse top. The location of the high frequency compensation trimmer(s) can also be found in the probe information sheet. These R-trimmer(s) have to be adjusted such that the beginning of the pulse is as straight as possible. Overshoot or excessive rounding are unacceptable.

The adjustment is relatively easy if only one adjusting point is present. In case of several adjusting points the adjustment is

slightly more difficult, but causes a better result. The rising edge should be as steep as possible, with a pulse top remaining as straight and horizontal as possible.

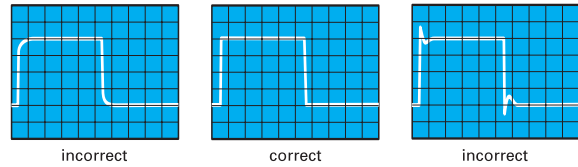

After completion of the HF-adjustment, the signal amplitude displayed on the CRT screen should have the same value as during the 1kHz adjustment.

Probes other than those mentioned above, normally have a larger tip diameter and may not fit into the calibrator outputs. Whilst it is not difficult for an experienced operator to build a suitable adapter, it should be pointed out that most of these probes have a slower risetime with the effect that the total bandwidth of scope together with probe may fall far below that of the HM303-6. Furthermore, the HF-adjustment feature is nearly always missing so that waveform distortion can not be entirely excluded.

The adjustment sequence must be followed in the order described, i.e. first at 1kHz, then at 1MHz. The calibrator frequencies should not be used for time base calibration. The pulse duty cycle deviates from 1:1 ratio. Prerequisites for precise and easy probe adjustments, as well as checks of deflection coefficients, are straight horizontal pulse tops, calibrated pulse amplitude, and zero-potential at the pulse base. Frequency and duty cycle are relatively unimportant. For interpretation of transient response, fast pulse risetimes and low-impedance generator outputs are of particular importance. Providing these essential features, as well as switch-selectable output-frequencies, the calibrator of the HM303-6 can, under certain conditions, replace expensive squarewave generators when testing or compensating wideband-attenuators or -amplifiers. In such a case, the input of an appropriate circuit will be connected to the CALIBRATOR-output via a suitable probe.

The voltage provided at a high-impedance input (1MΩ || 15-30pF) will correspond to the division ratio of the probe used (x10 = 20mVpp). Suitable probes are **HZ51**, **52**, and **54**.

## Operating modes of the vertical amplifiers

The vertical amplifier is set to the desired operating mode by using the 3 pushbuttons (**CH I/II**, **DUAL** and **ADD**) underneath the attenuator switches. For **Mono** mode all 3 buttons must be in their released positions; only channel I can then be operated. The button **CH I/II-TRIG.I/II** must be depressed in mono mode for Channel II. The internal triggering is simultaneously switched over to Channel II with this button. If the **DUAL** button is depressed, both channels are working. Two signals can be displayed together in this button position (alternate mode) if the time-base setting and the repetition frequency of the signal are suited. This mode is not suitable for displaying very slow-running processes. The display then flickers too much or it appears to jump. If the **ADD** button is depressed **in addition to DUAL**, both channels are switched over constantly at a high frequency within a sweep period (**CHOP** mode). Low frequency signals **below 1kHz, or with periods longer than 1ms** are then also displayed without flicker. CHOP mode is not recommended for signals with higher repetition frequencies.

If only the **ADD** button is depressed, the signals of both channels are algebraically added (+I ±II). Whether the resulting

display shows the **sum** or **difference** is dependent on the phase relationship or the polarity of the signals **and** on the positions of the **INV.** (invert) button.

In-phase input voltages:

- INV.** button released = sum.
- INV.** button depressed = difference.

Antiphase input voltages:

- INV.** button released = difference.
- INV.** button depressed = sum.

In the **ADD** mode the vertical display position is dependent upon the **Y-POS.** setting of **both** channels. The same attenuator switch position is normally used for both channels with algebraic addition.

Please note that the Y-POS. settings are added too but are not affected by the INV. pushbutton.

**Differential measurement** techniques allow direct measurement of the voltage drop across floating components (both ends above ground). Two identical probes should be used for both vertical inputs. In order to avoid ground loops, use a separate ground connection and do not use the probe ground leads or cable shields.

## X-Y Operation

For **X-Y operation**, the pushbutton underneath the **TIME/DIV.**-knob marked **XY** must be depressed. The X signal is then derived from the **INPUT CH I (X)**. **The calibration of the X signal during X-Y operation is determined by the setting of the Channel I input attenuator and variable control.** This means that the sensitivity ranges and input impedances are identical for both the X and Y axes. However, the **Y-POS.I** control is disconnected in this mode. Its function is taken over by the **X-POS.** control. It is important to note that the **X-MAG. x10** facility, normally used for expanding the sweep, is inoperative in the X-Y mode.

The bandwidth of the X amplifier, is lower than the Y amplifier and the phase angle which increases with higher frequencies, must be taken into account (please note "Specifications").

The inversion of the Y-input signal (**CH II**) using the **INV.** button is possible.

Lissajous figures can be displayed in the X-Y mode for certain measuring tasks:

- Comparing two signals of different frequency or bringing one frequency up to the frequency of the other signal. This also applies for whole number multiples or fractions of the one signal frequency.
- Phase comparison between two signals of the same frequency.

## Phase comparison with Lissajous figures

The following diagrams show two sine signals of the same frequency and amplitude with different phase angles.

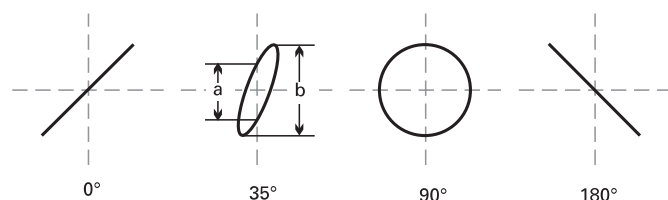

Calculation of the phase angle or the phase shift between the X and Y input voltages (after measuring the distances **a** and **b** on the screen) is quite simple with the following formula, and a pocket calculator with trigonometric functions. Apart from the reading accuracy, the signal height has no influence on the result.

$$\sin \varphi = \frac{a}{b}$$

$$\cos \varphi = \sqrt{1 - \left(\frac{a}{b}\right)^2}$$

$$\varphi = \arcsin \frac{a}{b}$$

### The following must be noted here:

- Because of the periodic nature of the trigonometric functions, the calculation should be limited to angles  $\leq 90^\circ$ . However here is the advantage of the method.
- Do not use a too high test frequency. The phase shift of the two oscilloscope amplifiers of the **HM303-6** in the X-Y mode can exceed an angle of  $3^\circ$  above 120 kHz.
- It cannot be seen as a matter of course from the screen display if the test voltage leads or lags the reference voltage. A CR network before the test voltage input of the oscilloscope can help here. The  $1 \text{ M}\Omega$  input resistance can equally serve as R here, so that only a suitable capacitor C needs to be connected in series. If the aperture width of the ellipse is increased (compared with C short-circuited), then the test voltage leads the reference voltage and vice versa. This applies only in the region up to  $90^\circ$  phase shift. Therefore C should be sufficiently large and produce only a relatively small just observable phase shift.

Should both input voltages be missing or fail in the X-Y mode, a very bright light dot is displayed on the screen. This dot can burn into the phosphor at a too high brightness setting (INTENS knob) which causes either a lasting loss of brightness, or in the extreme case, complete destruction of the phosphor at this point.

## Phase difference measurement in DUAL mode

A larger phase difference between two input signals of the same frequency and shape can be measured very simply on the screen in Dual mode (**DUAL** button depressed). The time base should be triggered by the reference signal (phase position 0).

The other signal can then have a leading or lagging phase angle. Alternate mode should be selected for frequencies  $\geq 1$  kHz; the Chop mode is more suitable for frequencies  $< 1$  kHz (less flickering).

For greatest accuracy adjust not much more than one period and approximately the same height of both signals on the screen. The variable controls for amplitude and time base and the **LEVEL** knob can also be used for this adjustment without influence on the result.

Both base lines are set onto the horizontal graticule center line with the **Y-POS** knobs before the measurement. With sinusoidal signals, observe the zero (crossover point) transitions; the sine peaks are less accurate. If a sine signal is noticeably distorted by even harmonics, or if a D.C. voltage is present, **AC** coupling is recommended for **both** channels. If it is a question of pulses of the same shape, read off at steep edges.

Phase difference measurement in DUAL mode

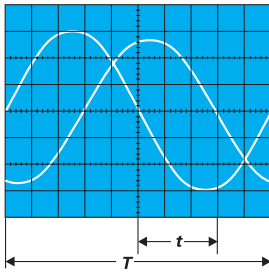

**t** = horizontal spacing of the zero transitions in div.  
**T** = horizontal spacing for one period in div.

In the example illustrated, **t** = 3div. and **T** = 10div. The phase difference in degrees is calculated from

$$\varphi^\circ = \frac{t}{T} \cdot 360^\circ = \frac{3}{10} \cdot 360^\circ = 108^\circ$$

or expressed in radians

$$\text{arc } \varphi^\circ = \frac{t}{T} \cdot 2\pi = \frac{3}{10} \cdot 2\pi = 1,885 \text{ rad}$$

Relatively small phase angles at not too high frequencies can be measured more accurately in the X-Y mode with Lissajous figures.

Measurement of an amplitude modulation

The momentary amplitude *u* at time *t* of a HF-carrier voltage, which is amplitude modulated without distortion by a sinusoidal AF voltage, is in accordance with the equation

$$u = U_T \cdot \sin \Omega t + 0,5m \cdot U_T \cdot \cos(\Omega - \omega) t - 0,5m \cdot U_T \cdot \cos(\Omega + \omega) t$$

where

- U<sub>T</sub>** = unmodulated carrier amplitude
- Ω** = 2πF = angular carrier frequency
- ω** = 2πf = modulation angular frequency
- m** = modulation factor (i.a. ≤ 100%).

The lower side frequency **F-f** and the upper side frequency **F+f** arise because of the modulation apart from the carrier frequency **F**.  
 Figure 1.

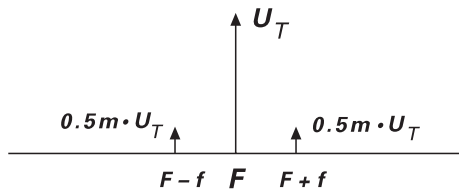

Amplitude and frequency spectrum for AM display (m = 50%)

The display of the amplitude-modulated HF oscillation can be evaluated with the oscilloscope provided the frequency spectrum is inside the oscilloscope bandwidth. The time base is set so that several cycles of the modulation frequency are visible. Strictly speaking, triggering should be external with modulation frequency (from the AF generator or a demodulator). However, internal triggering is frequently possible with normal triggering (**AT/NM** button depressed) using a suitable **LEVEL** setting and possibly also using the time variable adjustment.

Oscilloscope setting for a signal according to figure 2:

- Depress no buttons.
- Y: CH 1; 20mV/div.; AC.**
- TIME/DIV.: 0.2ms/div.**

Triggering: **NM** (NORMAL);  
 with **LEVEL**-setting;  
 internal (or external) triggering.

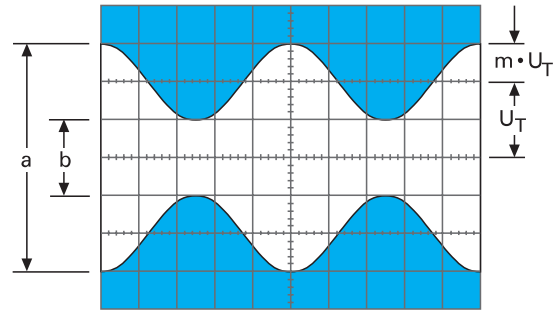

Figure 2.  
 Amplitude modulated oscillation:  
**F** = 1 MHz; **f** = 1 kHz;  
**m** = 50 %; **U<sub>T</sub>** = 28.3 mV<sub>rms</sub>.

If the two values **a** and **b** are read from the screen, the modulation factor is calculated from

$$m = \frac{a-b}{a+b} \text{ resp. } m = \frac{a-b}{a+b} \cdot 100 [\%]$$

where

$$a = U_T (1+m) \text{ and } b = U_T (1-m).$$

The variable controls for amplitude and time can be set arbitrarily in the modulation factor measurement. Their position does not influence the result.

Triggering and time base

Time related amplitude changes on a measuring signal (AC voltage) are displayable in Yt-mode. In this mode the signal voltage deflects the beam in vertical direction while the time base generator moves the beam from the left to the right of the screen (time deflection).

Normally there are periodically repeating waveforms to be displayed. Therefore the time base must repeat the time deflection periodically too. To produce a stationary display, the time base must only be triggered if the signal height and slope condition coincide with the former time base start conditions. A DC voltage signal can not be triggered as it is a constant signal with no slope.

Triggering can be performed by the measuring signal itself (internal triggering) or by an external supplied but synchronous voltage (external triggering).

The trigger voltage should have a certain minimum amplitude. This value is called the trigger threshold. It is measured with a sine signal. When the trigger voltage is taken internally from the test signal, the trigger threshold can be stated as vertical display height in div., through which the time base generator starts, the display is stable, and the trigger LED lights.

The internal trigger threshold of the **HM303-6** is given as £ 0.5div. When the trigger voltage is externally supplied, it can be measured in V<sub>pr</sub> at the **TRIG. EXT.** socket. Normally, the trigger threshold may be exceeded up to a maximum factor of 20.

The **HM303-6** has two trigger modes, which are characterized in the following.

## Automatic Peak (value) - Triggering

If the **AT/NM** pushbutton is in the out position **AT**, the sweep generator is running without test signal or external trigger voltage. A base line is always displayed even without a signal applied.

In automatic trigger mode the sweep generator can run without test signal or external trigger voltage. A base line will always be displayed even with no signal. With an applied **AC** signal the peak value triggering enables the user to select the voltage point on the trigger signal (trigger point), by the adjustment of the trigger **LEVEL** control. The control range depends on the peak to peak value of the signal. This trigger mode is therefore called **Automatic Peak (Value)- Triggering**. Operation of the scope needs only correct amplitude and time base settings, for a constantly visible trace. Automatic mode is recommended for all uncomplicated measuring tasks. However, automatic triggering is also the appropriate operation mode for the "entry" into difficult measuring problems, e.g. when the test signal is unknown relating to amplitude, frequency or shape. Presenting of all parameters is now possible with automatic triggering; the change to normal triggering can follow thereafter.

The automatic triggering works above 20Hz. The failure of automatic triggering at frequencies below 20Hz is abrupt. However, it is not signified by the trigger indicator LED this is still blinking. Break down of triggering is best recognizable at the left screen edge (the start of the trace in differing display height).

The automatic peak (value) triggering operates over all variations or fluctuations of the test signal above 20Hz. However, if the pulse duty factor of a square-wave signal exceeds a ratio of 100:1, switching over to normal triggering will be necessary. Automatic triggering is practicable with internal and external trigger voltage.

## Normal Triggering

With normal triggering (**AT/NM** button depressed) the sweep can be started by **AC** signals within the frequency range defined by the **TRIG. MODE** (trigger coupling) setting.

In the absence of an adequate trigger signal or when the trigger controls (particularly the **LEVEL** control) are misadjusted, no trace is visible, i.e. the screen blanked completely.

When using the internal normal triggering mode, it is possible to trigger at any amplitude point of a signal edge, even with very complex signal shapes, by adjusting the **LEVEL** control. Its adjusting range is directly dependent on the display height, which should be at least **0.5div**. If it is smaller than 1div., the **LEVEL** adjustment needs to be operated with a sensitive touch. In the external normal triggering mode, the same applies to approx. 0.3V<sub>pp</sub> external trigger voltage amplitude.

Other measures for triggering of very complex signals are the use of the time base variable control and **HOLDOFF** time control, hereinafter mentioned.

## Slope $\nearrow \searrow$

The time base generator can be started by a rising or falling edge of the test signal. This is valid with automatic and with normal triggering. The selected slope is set with the **SLOPE** ( $\nearrow \searrow$ ) pushbutton. The  $\nearrow$  sign (button released) means an edge, which is coming from a negative potential and rising to a positive potential. That has nothing to do with zero or ground potential and absolute voltage values. The positive slope may also lie in a negative part of a signal. A falling edge ( $\searrow$  sign) triggers, when the **SLOPE** ( $\nearrow \searrow$ ) pushbutton is depressed.

However the trigger point may be varied within certain limits on the chosen edge using the **LEVEL** control. The slope direction is always related to the input signal and the non inverted display.

## Trigger coupling

The coupling mode and accordingly the frequency range of the trigger signal can be changed using the **TRIG. MODE** selector switch.

### AC: Trigger range <20Hz to 100MHz.

This is the most frequently used trigger mode. The trigger threshold is increasing below 20Hz and above 100MHz.

### DC: Trigger range DC to 100MHz.

DC triggering is recommended, if the signal is to be triggered with quite slow processes or if pulse signals with constantly changing pulse duty factors have to be displayed.

With DC- or LF-trigger coupling, always work with normal triggering and **LEVEL** adjustment.

### LF: Trigger range DC to 1.5kHz (low-pass filter).

The LF position is often more suited for low-frequency signals than the DC position, because the (white) noise in the trigger voltage is strongly suppressed. So jitter or double-triggering of complex signals is avoidable or at least reduced, in particular with very low input voltages. The trigger threshold increases above 1.5kHz.

**TV:** The built-in **active TV-Sync-Separator** enables the separation of sync pulses from the video signal. Even distorted video signals are triggered and displayed in a stable manner.

Video signals are triggered in the automatic mode. The internal triggering is virtually independent of the display height, but the sync pulse must exceed 0.5div. height. For TV sync pulse separation the **TRIG. MODE** switch must be set to **TV**. The **TIME/DIV.**-switch selects between **field (0.2s/div. - 1ms/div.)** and **line (0.5ms/div. - 0.1µs/div.)**.

The slope of the leading edge of the synchronization pulse is critical for the **SLOPE** pushbutton setting. If the displayed sync pulses are **above** the picture (field) contents, then the **SLOPE** pushbutton ( $\nearrow \searrow$ ) must be in  $\nearrow$  position (out). In the case of sync pulses **below** the field/line, the leading edge is negative and the **SLOPE** pushbutton must therefore be depressed (to " $\searrow$ "). Since the **INV.** (invert) function may cause a misleading display, it must not be activated until after correct triggering is achieved.

On the 2ms/div setting field TV triggering is selected and 1 field is visible if a 50 fields/s signal is applied. If the holdoff control is in fully ccw position, it triggers without line interlacing affects caused by the consecutive field. More details in the video signal become visible if the **X-MAG. x10** pushbutton is depressed (in). The **X-POS.** control allows to display any part of the expanded signal. The influence of the integrating network which forms a trigger pulse from the vertical sync pulses may become visible under certain conditions.

Disconnecting the trigger circuit (e.g. by rapidly pressing and releasing the **TRIG. EXT.** button) can result in triggering the consecutive (**odd or even**) field.

On the 10µs/div setting line TV triggering is selected and approx. 1½ lines are visible. Those lines originate randomly from the odd and even fields.

The sync-separator-circuit also operates with external triggering. It is important that the voltage range (0.3V<sub>pp</sub> to 3V<sub>pp</sub>) for external

triggering should be noted. Again the correct slope setting is critical, because the external trigger signal may not have the same polarity or pulse edge as the test signal. This can be checked, if the external trigger voltage itself is displayed first (with internal triggering).

In most cases, the composite video signal has a high DC content. With constant video information (e.g. test pattern or color bar generator), the DC content can be suppressed easily by **AC** input coupling of the oscilloscope amplifier. With a changing picture content (e.g. normal program), **DC** input coupling is recommended, because the display varies its vertical position on screen with AC input coupling at each change of the picture content. The DC content can be compensated using the **Y-POS.** control so that the signal display lies in the graticule area. Then the composite video signal should not exceed a vertical height of 6div.

### Line triggering (~)

A voltage originating from mains/line (50 to 60Hz) is used for triggering purposes if the **AT/NM** and **ALT** pushbuttons are depressed ( ~ symbol). When the **AT/NM** pushbutton is depressed the instrument is automatically set to normal triggering.

This trigger mode is independent of amplitude and frequency of the Y signal and is recommended for all mains/line synchronous signals. This also applies within certain limits to whole number multiples or fractions of the line frequency. Line triggering can also be useful to display signals below the trigger threshold (less than 0.5div). It is therefore particularly suitable for measuring small ripple voltages of mains/line rectifiers or stray magnetic field in a circuit. In this trigger mode the **SLOPE** pushbutton selects the positive or negative portion of the line sinewave. The **LEVEL** control is operative for trigger point adjustment.

Magnetic leakage (e.g. from a power transformer) can be investigated for direction and amplitude using a search or pick-up coil. The coil should be wound on a small former with a maximum of turns of a thin lacquered wire and connected to a BNC connector (for scope input) via a shielded cable. Between cable and BNC center conductor a resistor of at least 100Ω should be series-connected (RF decoupling). Often it is advisable to shield statically the surface of the coil. However, no shorted turns are permissible. Maximum, minimum, and direction to the magnetic source are detectable at the measuring point by turning and shifting the coil.

### Alternate triggering

With **alternate triggering** (**ALT** button depressed) it is possible to trigger two signals which are different in frequency (asynchronous). In this case the oscilloscope must be operated in **alternate DUAL** mode with signals of sufficient height at each input. To avoid trigger problems due to different DC voltage components, **AC** input coupling for both channels is recommended.

The peak (value) detection which is normally present in automatic triggering mode (AT), is automatically switched off; the **LEVEL** control becomes inoperative and the trigger threshold is set to 0 Volt.

The internal trigger source is switched in the same way as the channel switching after each time base sweep.

Phase difference measurement is not possible in this trigger mode.

### External triggering

The internal triggering is disconnected by depressing the **TRIG. EXT.** button. The time base can be triggered externally via the **TRIG. EXT.** socket using a 0.3V<sub>pp</sub> to 3V<sub>pp</sub> voltage, which is in synchronism with the test signal. This trigger voltage may have completely different form from the test signal voltage. Triggering is even possible in certain limits with whole number multiples or fractions of the test frequency, but only with synchronous signals.

The input impedance of the **TRIG. EXT.** socket is approx. 100kΩ || 10pF. The maximum input voltage of the input circuit is 100V (DC+peak AC).

It must be noted that a different phase angle between the measuring and the triggering signal may cause a display not coinciding with the **SLOPE** pushbutton setting. The trigger coupling selection can also be used in external triggering mode. Unlike internal triggering, the lowest frequency for external triggering is 20Hz in all trigger coupling conditions.

### Trigger indicator

An LED on condition (above the **SLOPE** switch) indicates that the trigger signal has a sufficient amplitude and the **LEVEL** control setting is correct. This is valid with automatic and with normal triggering. The indication of trigger action facilitates a sensitive **LEVEL** adjustment, particularly at very low signal frequencies. The indication pulses are of only 100ms duration. Thus for fast signals the **TR**-LED appears to glow continuously, for low repetition rate signals, the LED flashes at the repetition rate or at a display of several signal periods not only at the start of the sweep at the left screen edge, but also at each signal period.

In automatic triggering mode the sweep generator starts repeatedly without test signal or external trigger voltage. If the trigger signal frequency is <20Hz the sweep generator starts without awaiting the trigger pulse. This causes an untriggered display and a flashing trigger LED (TR).

### Holdoff-time adjustment

If it is found that a trigger point cannot be located on extremely complex signals even after repeated and careful adjustment of the **LEVEL** control, a stable display may be obtained using the **HOLD OFF** control. This facility varies the hold-off time between two sweep periods approx. up to the ratio 10:1. Pulses or other signal waveforms appearing during this off period cannot trigger the time base. Particularly with burst signals or aperiodic pulse trains of the same amplitude, the start of the sweep can be delayed until the optimum or required moment.

A very noisy signal or a signal with a higher interfering frequency is at times displayed double. It is possible that **LEVEL** adjustment only controls the mutual phase shift, but not the double display. The stable single display of the signal, required for evaluation, is easily obtainable by expanding the holdoff time. To this end the **HOLD OFF** knob is slowly turned to the right, until one signal is displayed. A double display is possible with certain pulse signals, where the pulses alternately show a small difference of the peak amplitudes. Only a very exact **LEVEL** adjustment makes a single display possible. The use of the **HOLD OFF** knob simplifies the right adjustment.

After specific use the **HOLD OFF** control should be reset into its calibration detent (fully ccw), otherwise the brightness of the display is reduced drastically. The function is shown in the following figures.



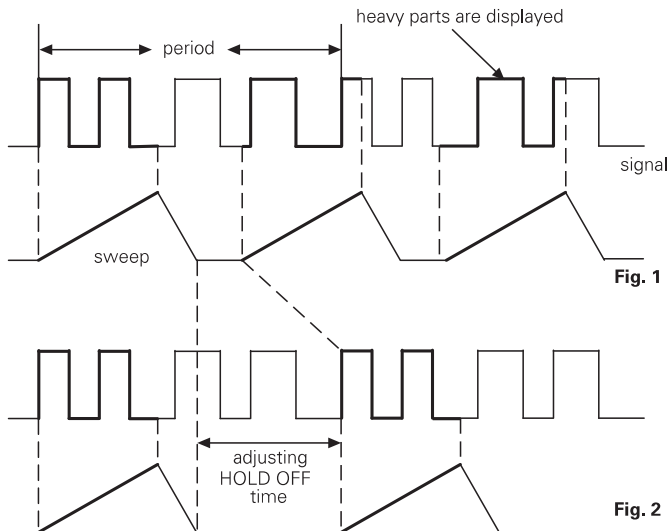

**Fig. 1** shows a case where the **HOLD OFF** knob is in the minimum position and various different waveforms are overlapped on the screen, making the signal observation unsuccessful.

**Fig. 2** shows a case where only the desired parts of the signal are stably displayed.

## Component Tester

### General

The **HM303-6** has a built-in electronic Component Tester (**COMP. TESTER**), which is used for instant display of a test pattern to indicate whether or not components are faulty. The **COMP. TESTER** can be used for quick checks of semiconductors (e.g. diodes and transistors), resistors, capacitors, and inductors. Certain tests can also be made to integrated circuits. All these components can be tested in and out of circuit.

The test principle is fascinatingly simple. A built-in generator delivers a sine voltage, which is applied across the component under test and a built-in fixed resistor. The sine voltage across the test object is used for the horizontal deflection, and the voltage drop across the resistor (i.e. current through test object) is used for vertical deflection of the oscilloscope. The test pattern shows a current-voltage characteristic of the test object.

Since this circuit operates with a frequency of 50Hz ( $\pm 10\%$ ) and a voltage of approx. 7Vrms (open circuit), the indicating range of the component tester is limited. The impedance of the component under test is limited to a range from  $20\Omega$  to  $4.7k\Omega$ . Below and above these values, the test pattern shows only short-circuit or open-circuit. For the interpretation of the displayed test pattern, these limits should always be borne in mind. However, most electronic components can normally be tested without any restriction.

### Using the Component Tester

The component tester is switched on by depressing the **COMP. TESTER** pushbutton (on) beneath the screen. This makes the vertical preamplifier and the time base generator inoperative. A shortened horizontal trace will be observed. It is not necessary to disconnect scope input cables unless in-circuit measurements are to be carried out. In the **COMP. TESTER** mode, the only controls which can be operated are **INTENS**, **FOCUS**, **X-POS.** and **X-MAG. X10 pushbutton (must be released)**. All other controls and settings have no influence on the test operation.

For the component connection, two simple test leads with 4mm  $\varnothing$  banana plugs, and with test prod, alligator clip or sprung hook, are required. The test leads are connected to the insulated socket and the adjacent ground socket beneath the screen. The component can be connected to the test leads either way round.

After use, to return the oscilloscope to normal operation, release the **COMP. TESTER** pushbutton (off).

### Test Procedure

#### Caution!

**Do not test any component in live circuitry - remove all grounds, power and signals connected to the component under test. Set up Component Tester as stated above. Connect test leads across component to be tested. Observe oscilloscope display.**

**Only discharged capacitors should be tested!**

### Test Pattern Displays

- Open circuit is indicated by a straight horizontal line.
- Short circuit is shown by a straight vertical line.

### Testing Resistors

If the test object has a linear ohmic resistance, both deflecting voltages are in the same phase. The test pattern expected from a resistor is therefore a sloping straight line. The angle of slope is determined by the resistance of the resistor under test. With high values of resistance, the slope will tend towards the horizontal axis, and with low values, the slope will move towards the vertical axis.

Values of resistance from  $20\Omega$  to  $4.7k\Omega$  can be approximately evaluated. The determination of actual values will come with experience, or by direct comparison with a component of a known value.

### Testing Capacitors and Inductors

Capacitors and inductors cause a phase difference between current and voltage, and therefore between the X and Y deflection, giving an ellipse-shaped display. The position and opening width of the ellipse will vary according to the impedance value (at 50Hz) of the component under test.

A horizontal ellipse indicates a high impedance or a relatively small capacitance or a relatively high inductance.

A vertical ellipse indicates a small impedance or a relatively large capacitance or a relatively small inductance.

**A sloping ellipse means that the component has a considerable ohmic resistance in addition to its reactance.**

The values of capacitance of normal or electrolytic capacitors from  $0.1\mu\text{F}$  to  $1000\mu\text{F}$  can be displayed and approximate values obtained. More precise measurement can be obtained in a smaller range by comparing the capacitor under test with a capacitor of known value. Inductive components (coils, transformers) can also be tested. The determination of the value of inductance needs some experience, because inductors have usually a higher ohmic series resistance. However, the impedance value (at 50Hz) of an inductor in the range from  $20\Omega$  to  $4.7k\Omega$  can easily be obtained or compared.

## Testing Semiconductors

Most semiconductor devices, such as diodes, Z-diodes, transistors, FETs can be tested. The test pattern displays vary according to the component type as shown in the figures below.

The main characteristic displayed during semiconductor testing is the voltage dependent knee caused by the junction changing from the conducting state to the non conducting state. It should be noted that both the forward and the reverse characteristic are displayed simultaneously. This is a two-terminal test, therefore testing of transistor amplification is not possible, but testing of a single junction is easily and quickly possible. Since the test voltage applied is only very low, all sections of most semiconductors can be tested without damage. However, checking the breakdown or reverse voltage of high voltage semiconductors is not possible. More important is testing components for open or short-circuit, which from experience is most frequently needed.

## Testing Diodes

Diodes normally show at least their knee in the forward characteristic. This is not valid for some high voltage diode types, because they contain a series connection of several diodes. Possibly only a small portion of the knee is visible. Z-diodes always show their forward knee and, up to approx. 9V, their Z-breakdown, forms a second knee in the opposite direction. A Z-breakdown voltage of more than approx. 9V can not be displayed.

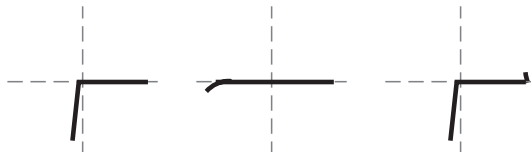

Type: **Normal Diode**      **Highvolt.-Diode**      **Z-Diode 6.8V**  
 Terminals: Cathode-Anode      Cathode-Anode      Cathode-Anode  
 Connections: (CT-GD)      (CT-GD)      (CT-GD)

The polarity of an unknown diode can be identified by comparison with a known diode.

## Testing Transistors

Three different tests can be made to transistors: base-emitter, base-collector and emitter-collector. The resulting test patterns are shown below.

The basic equivalent circuit of a transistor is a Z-diode between base and emitter and a normal diode with reverse polarity between base and collector in series connection. There are three different test patterns:



**N-P-N Transistor**  
 Terminals: B-E      B-C      E-C  
 Connections: (CT-GD)      (CT-GD)      (CT-GD)



**P-N-P Transistor**  
 Terminals: B-E      B-C      E-C  
 Connections: (CT-GD)      (CT-GD)      (CT-GD)

For a transistor the figures b-e and b-c are important. The figure e-c can vary; but a vertical line only shows short circuit condition.

These transistor test patterns are valid in most cases, but there are exceptions (e.g. Darlington, FETs). With the **COMP. TESTER**, the distinction between a P-N-P and an N-P-N transistor is discernible. In case of doubt, comparison with a known type is helpful. It should be noted that the same socket connection (**COMP. TESTER** or ground) for the same terminal is then absolutely necessary. A connection inversion effects a rotation of the test pattern by 180 degrees round about the center point of the scope graticule.

**Pay attention to the usual caution with single MOS-components relating to static discharge or frictional electricity!**

## In-Circuit Tests

The test patterns show some typical displays for in-circuit tests.

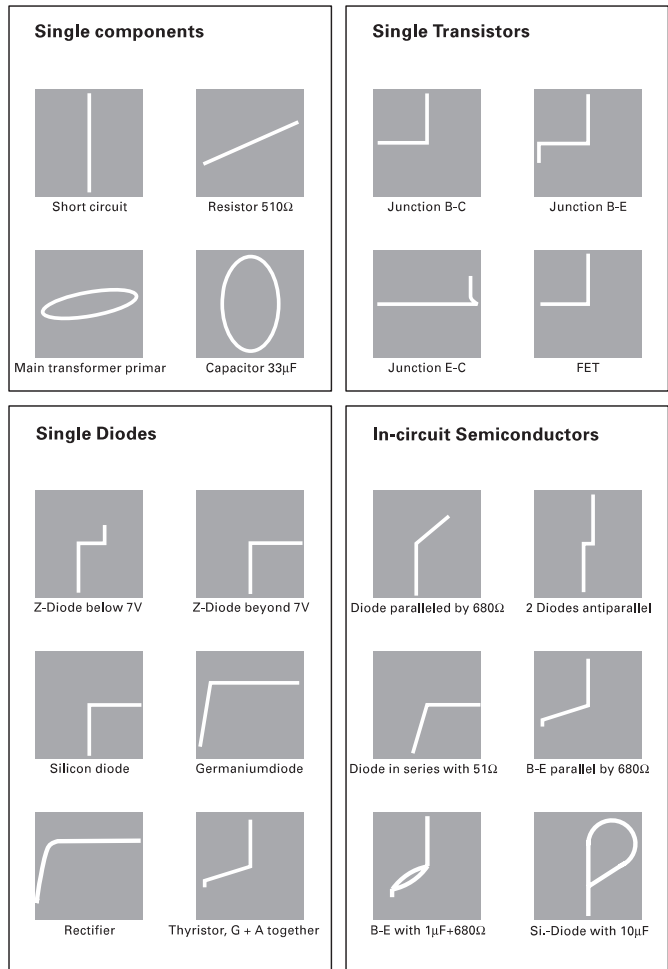

**Caution!**  
**During in-circuit tests make sure the circuit is dead. No power from mains/line or battery and no signal inputs are permitted. Remove all ground connections including Safety Earth (pull out power plug from outlet). Remove all measuring cables including probes between oscilloscope and circuit under test. Otherwise both COMP. TESTER leads are not isolated against the circuit under test.**

In-circuit tests are possible in many cases. However, they are not well defined. This is caused by a shunt connection of real or complex impedances - especially if they are of relatively low impedance at 50Hz - to the component under test, often results differ greatly when compared with single components. In case of doubt, one component terminal may be unsoldered. This terminal should then be connected to the insulated **COMP. TESTER** socket avoiding hum distortion of the test pattern.

Another way is a test pattern comparison to an identical circuit which is known to be operational (likewise without power and any external connections). Using the test prods, identical test points in each circuit can be checked, and a defect can be determined quickly and easily. Possibly the device itself under test contains a reference circuit (e.g. a second stereo channel, push-pull amplifier, symmetrical bridge circuit), which is not defective.

# Front Panel Elements HM 303-6 (Brief Description - Front View)

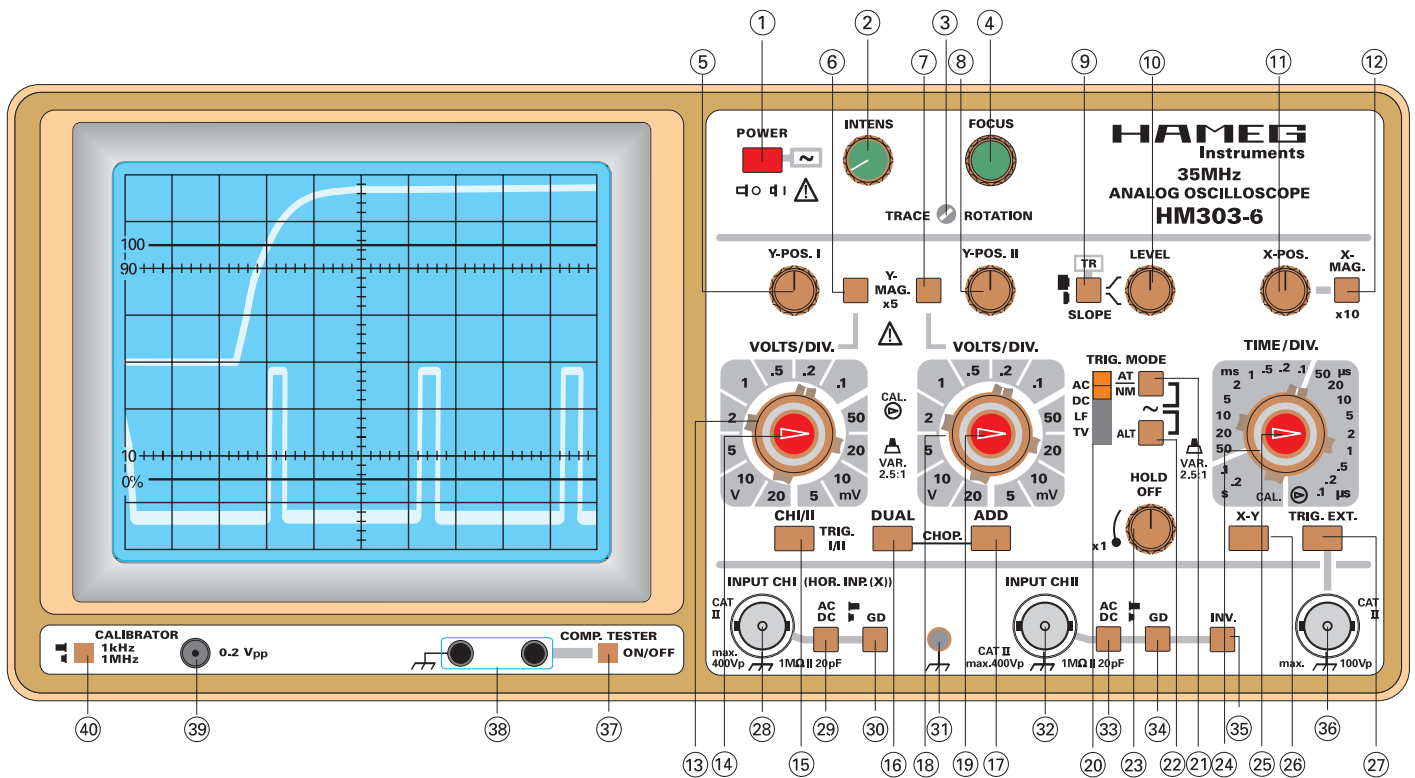

Element	Function
① <b>POWER</b> (pushbutton + LED)	Turns scope on and off. LED indicates operating condition.
② <b>INTENS</b> (knob)	Intensity control for trace brightness
③ <b>TRACE ROTATION</b> (potentiometer; adjustment with screwdriver)	To align trace with horizontal graticule line. Compensates influence of earth's magnetic field.
④ <b>FOCUS</b> (knob)	Focus control for trace sharpness.
⑤ <b>Y-POS. I</b> (knob)	Controls vertical position of channel I display. Inoperative in X-Y mode.
⑥ <b>Y MAG. x5</b> (pushbutton switch)	When depressed, increasing of Y-sensitivity CH I 5 fold (max. 1mV/div.)
⑦ <b>Y MAG. x5</b> (pushbutton switch)	When depressed, increasing of Y-sensitivity CH II 5 fold (max. 1mV/div.)
⑧ <b>Y-POS. II</b> (knob)	Controls vertical position of channel II display.
⑨ <b>SLOPE</b> $\nearrow \searrow$	Selects the slope of the trigger signal.

Element	Function
⑩ <b>SLOPE</b> $\nearrow \searrow$ (pushbutton switch)	$\nearrow$ = rising edge; $\searrow$ = falling edge.
<b>TR</b> (LED)	LED lights, if sweep is triggered.
⑪ <b>LEVEL</b> (knob)	Adjustment of trigger level.
⑫ <b>X-POS.</b> (knob)	Controls horizontal position of trace.
⑬ <b>X-MAG. x10</b> (pushbutton switch)	10:1 expansion in the X direction. Max. resolution 10ns/div. (inoperative in XY-mode).
⑭ <b>VOLTS/DIV.</b> (12 position rotary switch)	Channel I input attenuator. Selects Y input sensitivity in mV/div. or V/div. in 1-2-5 sequence.
⑮ <b>VAR. GAIN</b> (knob)	Fine adjustment of Y amplitude CH I. Increases attenuation factor min. by 2.5 (left hand stop). For amplitude measurement must be in CAL. position (right hand stop).
⑯ <b>CH I/II-TRIG. I/II</b> (pushbutton switch)	No button depressed: CH I only and triggering from channel I. When depressed, channel II only and triggering from channel II. (Trigger selection in DUAL mode).

## Front Panel Elements HM 303-6 (Brief Description - Front View)

Element	Function	Element	Function
⑩ <b>DUAL</b> (pushbutton switch)	Button released: one channel only. Button depressed: channel I and channel II in alternating mode.	⑫ <b>XY</b> (pushbutton switch)	Selects X-Y operation, stops sweep. X signal via CH I. Attention! Phosphor burn-in without signal.
	<b>CHOP.</b> DUAL and ADD buttons depressed: CH I and CH II in chopped mode.	⑬ <b>TRIG. EXT.</b> (pushbutton switch)	Button released = internal trig. Button depressed = external triggering, trigger signal via TRIG. EXT. BNC socket.
⑪ <b>ADD</b> (pushbutton switch)	ADD depressed only: algebr. addition. In combination with INV.: difference.	⑭ <b>INPUT CH I</b> (BNC socket)	Channel I signal input and input for horizontal deflection in X-Y mode. Input impedance 1M $\Omega$ II 20pF.
⑰ <b>VOLTS/DIV.</b> (12 position rotary switch)	Channel II input attenuator. Selects Y input sensitivity in mV/div. or V/div. in 1-2-5 sequence.	⑮ <b>AC-DC</b> (pushbutton switch)	Selects input coupling of CH I vertical amplifier. DC = direct coupling AC = coupling via capacitor.
⑱ <b>VAR. GAIN</b> (knob)	Fine adjustment of Y amplitude CH II. Increases attenuation factor min. by 2.5 (left hand stop). For amplitude measurement must be in CAL. position (right hand stop).	⑯ <b>GD</b> (pushbutton switch)	GD = signal disconnected from input, Y amplifier grounded.
⑲ <b>TRIG. MODE</b> (switch) AC-DC-LF-TV	Trigger selector: <b>AC:</b> 10Hz-100MHz. <b>DC:</b> DC-100MHz. <b>LF:</b> DC-1.5kHz. <b>TV:</b> Triggering for frame and line.	⑳ (4mm socket)	Connector for reference potential (galvanically connected to earth).
⑳ <b>AT/NM</b> (pushbutton switch)	Button released = autom. trig. trace visible without input signal. Button depressed = normal trig. with LEVEL adjustment.	㉑ <b>INPUT CH II</b> (BNC socket)	CH II signal input. Input impedance 1M $\Omega$ II 20pF.
	<b>AT/NM</b> and <b>ALT</b> pushbuttons depressed: Internal line triggering in combination with normal triggering.	㉒ <b>AC-DC</b> (pushbutton switch)	Selects input coupling of the CH II vertical amplifier. Specs see (29).
㉑ <b>ALT</b> (pushbutton switch)	Triggering alternates between CH I and CH II in alternating DUAL Channel mode only.	㉓ <b>GD</b> (pushbutton switch)	GD = signal disconnected from input, Y amplifier grounded.
㉒ <b>HOLD OFF</b> (knob)	Controls holdoff-time between sweeps. Normal position = full ccw.	㉔ <b>INV.</b> (pushbutton switch)	Inversion of CH II display. In combination with ADD button = difference CH I, CH II.
㉓ <b>TIME/DIV.</b> (rotary switch)	Selects time coefficients (speeds) of time base, from 0.2s/div. to 0.1 $\mu$ s/div.	㉕ <b>TRIG. EXT.</b> (BNC socket)	Input for external trigger signal. (Pushbutton TRIG. EXT. depressed.)
㉔ <b>Variable time base control</b> (center knob)	Variable adjustment of time base. Decreases time deflection speed at least 2.5 fold. For time measurements turn to right hand stop.	㉖ <b>COMP. TESTER</b> (pushbutton switch)	Switch to convert oscilloscope to component tester mode. Release X-MAG. X10 pushbutton.
		㉗ <b>COMP. TESTER</b> (4mm sockets)	Connectors for test leads of the Component tester.
		㉘ <b>0.2V<sub>pp</sub></b> (test socket)	Calibrator square wave output 0,2V <sub>pp</sub> .
		㉙ <b>CALIBRATOR 1kHz/1MHz</b> (pushbutton switch)	Selects calibrator frequency. Button released: approx. 1kHz, Button depressed: approx. 1MHz.

# Short Instruction for HM303-6

---

## Switching on and initial setting

Connect instrument to power outlet, depress red **POWER** button. LED indicates operating condition.

**Case, chassis and all measuring terminals are connected to the safety earth conductor (Safety Class I).**

Do not depress any further button. **TRIG. MODE** selector switch to **AC**.

**AT/NM** button released, **CH I** input coupling switch to **GD**, set **TIME/DIV.** switch to 50 $\mu$ s/div.

Adjust **INTENS** control for average brightness.

Center trace on screen using **X-POS.** and **Y-POS.I** controls. Then focus trace using **FOCUS** control.

## Vertical amplifier mode

Channel I: **CH I/II**, **DUAL** and **ADD** pushbuttons in out position.

Channel II: **CH I/II** pushbutton depressed.

Channel I and II: **DUAL** pushbutton depressed. Alternate channel switching: **ADD (CHOP.)** pushbutton in out position.

Signals <1kHz or time coefficient  $\geq 1$ ms/div: **DUAL** and **ADD (CHOP.)** buttons depressed.

Channel I+II (sum): depress only **ADD** button.

Channel I-II (difference): depress **ADD** and **INV.** pushbuttons.

## Triggering mode

Select trigger mode with **AT/NM** pushbutton:

**AT** = Automatic Peak (value) Triggering <20Hz to 60MHz (out position). **NM** = Normal Triggering (depressed).

Trigger edge direction: select slope with **SLOPE ( $\nearrow$ )** pushbutton.

Internal triggering: select channel with **TRIG. I/II (CH I/II)** pushbutton.

Alternating triggering (internal): **DUAL** and **ALT.** pushbuttons depressed, **ADD (CHOP.)** pushbutton in the out position.

External triggering: **TRIG. EXT.** pushbutton depressed; sync signal (0.3V<sub>pp</sub> to 3V<sub>pp</sub>) to **TRIG. EXT.** socket.

Line triggering (normal triggering): **AT/NM** and **ALT** pushbuttons depressed ( $\sim$ ).

Select trigger coupling with **TRIG. MODE** selector switch. Trigger frequency ranges:

**AC**: >20Hz to 100MHz; **DC**: DC to 100MHz; **LF**: DC to 1.5kHz.

**TV**: Composite video signal with line or horizontal frequency.

**TIME/DIV. 0.2s/div. - 1ms/div.** = field frequency

**TIME/DIV. 0.5ms/div. - 0.1 $\mu$ s/div.** = line frequency

Select edge direction with **SLOPE ( $\nearrow$ )** pushbutton (sync. pulse above  $\nearrow$ , below  $\searrow$ ).

Pay attention to trigger indicator: **TR** LED above the **SLOPE** pushbutton.

## Measurements

Apply test signal to the vertical input connectors of **CH I** and/or **CH II**.

Before use, calibrate attenuator probe with square wave **CALIBRATOR**-signal.

Switch input coupling to **AC** or **DC**.

Adjust signal to desired display height with attenuator switch (**VOLTS/DIV.**).

Select time coefficient on the **TIME/DIV.** switch.

Set trigger point with **LEVEL** knob for normal triggering.

Trigger complex or aperiodic signals with longer **HOLD OFF**-time.

Amplitude measurement with Y fine control at right stop (**CAL.**).

Time measurement with time fine control at right stop (**CAL.**).

Horizontal expansion 10 fold with **X-MAG. x10** button depressed.

External horizontal deflection (**X-Y mode**) with **XY** pushbutton depressed (X input: **CH I**).

## Component Tester

Press **COMP. TESTER** pushbutton (on). Connect both component terminals to **COMP. TESTER** jacks.

**In-circuit test:** Circuit under test must be disconnected from battery or power (pull out power plug), signals and ground (earth).

Remove all signal connections to HM303-6 (cable, probe), release **X-MAG. X10** pushbutton, then start testing.

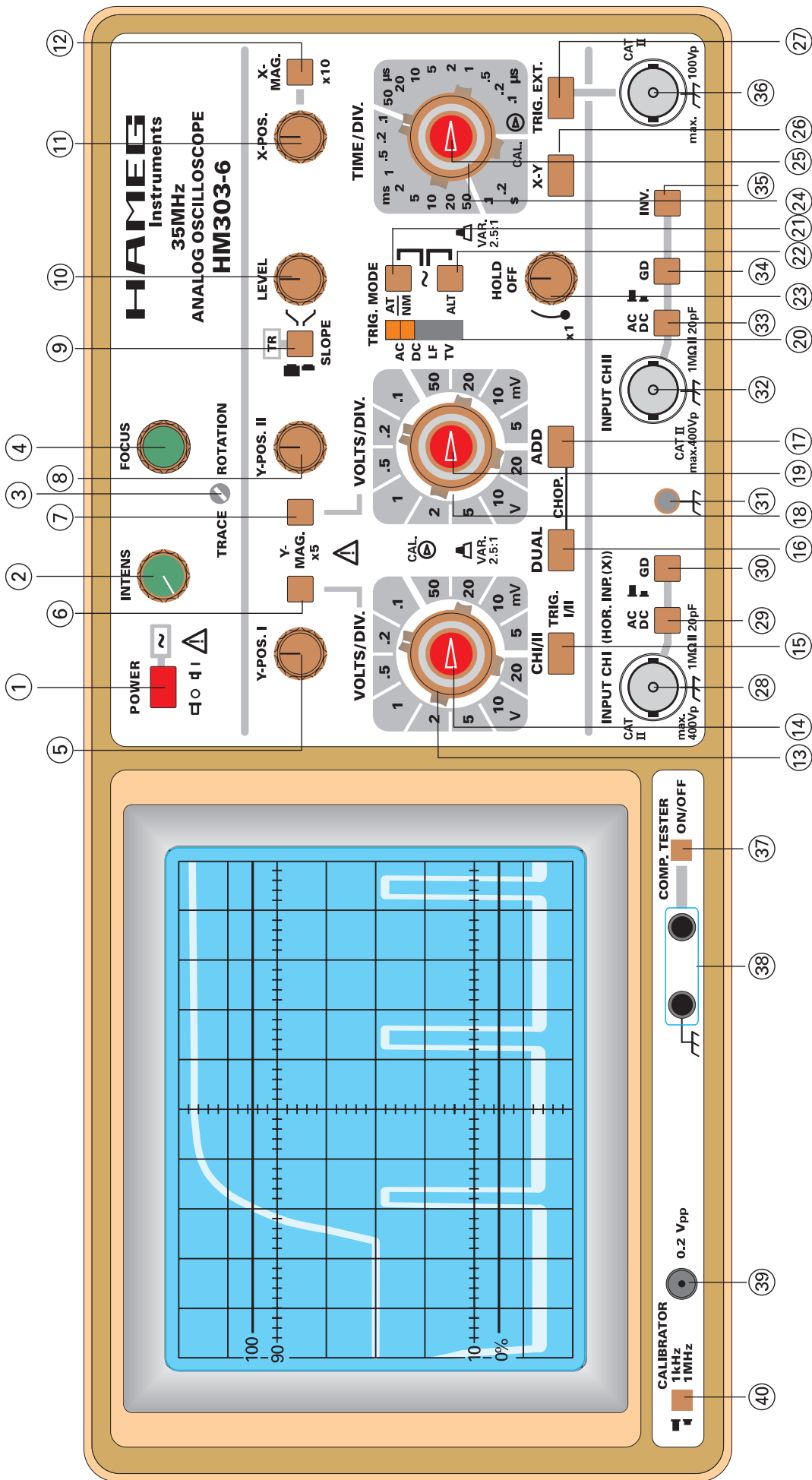

- ① POWER
- ② INTENS
- ③ FOCUS
- ④ ROTATION
- ⑤ Y-POS. I
- ⑥ Y-POS. II
- ⑦ Y-MAG. x5
- ⑧ Y-MAG. x10
- ⑨ TR
- ⑩ SLOPE
- ⑪ LEVEL
- ⑫ X-POS.
- ⑬ X-MAG. x10
- ⑭ VAR. 2.5:1
- ⑮ CAL.
- ⑯ VAR. 2.5:1
- ⑰ CAL.
- ⑱ VAR. 2.5:1
- ⑲ TRIG. MODE
- ⑳ TRIG. EXT.
- ㉑ HOLD OFF
- ㉒ INV.
- ㉓ CHOP.
- ㉔ DUAL
- ㉕ ADD
- ㉖ CH I/II
- ㉗ CH II
- ㉘ CH I (HOR. INP. (X))
- ㉙ CH II
- ㉚ CH I
- ㉛ CH II
- ㉜ COMP. TESTER ON/OFF
- ㉝ CALIBRATOR 1kHz 1MHz 0.2 Vpp
- ㉞ CAT II max. 400Vp 1MΩ II 20pF
- ㉟ CAT II max. 400Vp 1MΩ II 20pF
- ㊱ CAT II max. 100Vp 1MΩ II 20pF

Oscilloscopes



Spectrum Analyzer

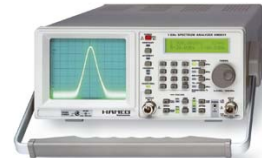

Power Supplies



Modular System  
8000 Series



Programmable Instruments  
8100 Series



authorized dealer



41-0303-06E0

[www.hameg.com](http://www.hameg.com)

Subject to change without notice  
41-0303-06E0 / 20012007-gw  
© HAMEG Instruments GmbH  
A Rohde & Schwarz Company  
® registrierte Marke



DQS-Zertifikation: DIN EN ISO 9001:2000  
Reg.-Nr.: 071040 QM

HAMEG Instruments GmbH  
Industriestraße 6  
D-63533 Mainhausen  
Tel +49 (0) 61 82 800-0  
Fax +49 (0) 61 82 800-100  
sales@hameg.de