

Errata

Title & Document Type: 5316A Universal Counter Operating & Service Manual

Manual Part Number: 05316-90001

Revision Date: May 1981

HP References in this Manual

This manual may contain references to HP or Hewlett-Packard. Please note that Hewlett-Packard's former test and measurement, semiconductor products and chemical analysis businesses are now part of Agilent Technologies. We have made no changes to this manual copy. The HP XXXX referred to in this document is now the Agilent XXXX. For example, model number HP8648A is now model number Agilent 8648A.

About this Manual

We've added this manual to the Agilent website in an effort to help you support your product. This manual provides the best information we could find. It may be incomplete or contain dated information, and the scan quality may not be ideal. If we find a better copy in the future, we will add it to the Agilent website.

Support for Your Product

Agilent no longer sells or supports this product. You will find any other available product information on the Agilent Test & Measurement website:

www.tm.agilent.com

Search for the model number of this product, and the resulting product page will guide you to any available information. Our service centers may be able to perform calibration if no repair parts are needed, but no other support from Agilent is available.

OPERATING AND SERVICE MANUAL

5316A 100 MHz Universal Counter



- General Information*
- Installation*
- Operation and Programming*
- Performance Tests*
- Adjustments*
- Replaceable Parts*
- Manual Changes*
- Service*

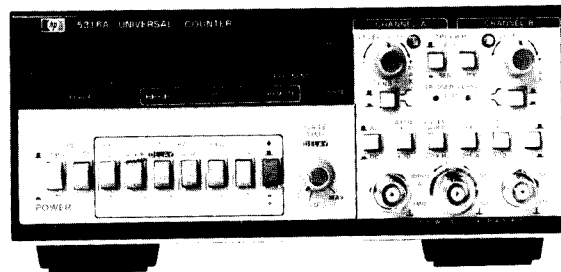

CERTIFICATION

Hewlett-Packard Company certifies that this product met its published specifications at the time of shipment from the factory. Hewlett-Packard further certifies that its calibration measurements are traceable to the United States National Bureau of Standards, to the extent allowed by the Bureau's calibration facility, and to the calibration facilities of other International Standards Organization members.

WARRANTY

This Hewlett-Packard instrument product is warranted against defects in material and workmanship for a period of one year from date of shipment. During the warranty period, Hewlett-Packard Company will, at its option, either repair or replace products which prove to be defective.

For warranty service or repair, this product must be returned to a service facility designated by HP. Buyer shall prepay shipping charges to HP and HP shall pay shipping charges to return the product to Buyer. However, Buyer shall pay all shipping charges, duties, and taxes for products returned to HP from another country.

HP warrants that its software and firmware designated by HP for use with an instrument will execute its programming instructions when properly installed on that instrument. HP does not warrant that the operation of the instrument, or software, or firmware will be uninterrupted or error free.

LIMITATION OF WARRANTY

The foregoing warranty shall not apply to defects resulting from improper or inadequate maintenance by Buyer, Buyer-supplied software or interfacing, unauthorized modification or misuse, operation outside of the environmental specifications for the product, or improper site preparation or maintenance.

NO OTHER WARRANTY IS EXPRESSED OR IMPLIED. HP SPECIFICALLY DISCLAIMS THE IMPLIED WARRANTIES OF MERCHANTABILITY AND FITNESS FOR A PARTICULAR PURPOSE.

EXCLUSIVE REMEDIES

THE REMEDIES PROVIDED HEREIN ARE BUYER'S SOLE AND EXCLUSIVE REMEDIES. HP SHALL NOT BE LIABLE FOR ANY DIRECT, INDIRECT, SPECIAL, INCIDENTAL, OR CONSEQUENTIAL DAMAGES, WHETHER BASED ON CONTRACT, TORT, OR ANY OTHER LEGAL THEORY.

ASSISTANCE

Product maintenance agreements and other customer assistance agreements are available for Hewlett-Packard products.

For any assistance, contact your nearest Hewlett-Packard Sales and Service Office. Addresses are provided at the back of this manual.

OPERATING AND SERVICE MANUAL

5316A 100 MHz Universal Counter

SERIAL PREFIX: 2120A

This manual applies to Serial Prefix 2120A, unless accompanied by a Manual Change Sheet indicating otherwise.

First Edition — May 1981

©Copyright 1981
by
HEWLETT-PACKARD COMPANY
5301 Stevens Creek Boulevard
Santa Clara, California 95050

MANUAL PART NUMBER 05316-90001
Microfiche Part Number 05316-90002

 **HEWLETT
PACKARD**

TABLE OF CONTENTS

Section	Title	Page
I	GENERAL INFORMATION	1-1
	1-1. Introduction	1-1
	1-4. Description	1-1
	1-9. Specifications	1-1
	1-11. Options	1-5
	1-16. Safety Considerations	1-5
	1-18. Instrument Identification	1-5
	1-20. Accessories	1-5
	1-22. Recommended Test Equipment	1-6
II	INSTALLATION	2-1
	2-1. Introduction	2-1
	2-3. Unpacking and Inspection	2-1
	2-5. Preparation for Use	2-1
	2-6. Power Requirements	2-1
	2-8. Line Voltage Selection	2-1
	2-14. Power Cable	2-2
	2-16. Operating Environment	2-2
	2-19. Storage and Shipment	2-2
	2-20. Environment	2-2
	2-23. Packaging	2-3
	2-26. Field Installation of Options	2-3
	2-28. Part Numbers for Ordering Option Kits	2-4
	2-30. Option 001 TCXO Installation	2-4
	2-32. Option 004 Installation	2-5
	2-34. Option 003 Channel C Installation	2-5
III	OPERATION	3-1
	3-1. Introduction	3-1
	3-3. Operating Characteristics	3-1
	3-6. Modes of Operation	3-1
	3-8. FREQ A	3-1
	3-10. PER A	3-2
	3-12. T.I. A→B	3-2
	3-14. T.I. AVG A→B	3-2
	3-17. T.I. DELAY (Hold Off)	3-3
	3-19. RATIO A/B	3-3
	3-21. A BY B	3-3
	3-23. A ARMED BY B	3-4
	3-27. FREQ C (Option 003)	3-6
	3-29. TOT STOP/START	3-6
	3-31. CHECK	3-6
	3-33. Display Check	3-6
	3-35. Panel Features and Controls	3-7
	3-37. Function Selection Controls	3-7
	3-42. Signal Conditioning Controls	3-8
	3-45. Trigger Level/Sensitivity Controls	3-8
	3-47. Display	3-8
	3-49. Operator's Checks	3-10
	3-51. Operating Instructions	3-10
	3-52. Power-Up Self-Check	3-10
	3-55. Measurement Procedures	3-11
	3-57. Frequency, Period, and Ratio Measurements	3-11
	3-58. Time Interval Measurements	3-12
	3-59. Troubleshooting/Error Messages	3-12

TABLE OF CONTENTS (Continued)

Section	Title	Page
III	OPERATION (Continued)	
	3-62. Options	3-13
	3-64. Time Base Options	3-13
	3-66. Channel C Option 003	3-13
	3-68. Operator's Maintenance	3-13
	3-71. Power/Warm Up	3-14
	3-73. Remote Programming via the HP-IB	3-29
	3-74. Introduction	3-29
	3-77. Bus Compatibility	3-29
	3-78. Interface Function	3-29
	3-81. Bus Messages	3-30
	3-83. Address Selection	3-30
	3-86. Front Panel HP-IB Status LEDs	3-32
	3-88. Device Command D	3-32
	3-93. Input Code Format	3-36
	3-95. Output Format	3-36
	3-98. Programming Examples	3-36
	3-101. Special Programming Considerations	3-38
IV	PERFORMANCE TESTS	4-1
	4-1. Introduction	4-1
	4-3. Operational Verification	4-1
	4-5. Performance Tests	4-1
	4-7. Equipment Required	4-1
	4-9. Test Record	4-1
	4-11. HP-IB Verification	4-12
V	ADJUSTMENTS	5-1
	5-1. Introduction	5-1
	5-4. Equipment Required	5-1
	5-6. Factory Selected Components	5-1
	5-8. Adjustment Locations	5-2
	5-10. A1 Power Supply Adjustments	5-2
	5-12. A4 Input Offset Adjustments	5-3
	5-14. A6 Digital-to-Analog Converter Adjustments (Remote Trigger Levels)	5-4
	5-16. A3 Trigger Level Gain Compensation	5-5
	5-18. A1 Injection-Locked Multiplier Amplifier Adjustment	5-8
	5-20. A7 Time Base Reference Adjustment — Standard Instrument	5-9
	5-22. A7 Option 001 TCXO Adjustment	5-10
	5-26. A7 Option 004 Oven Oscillator	5-12
	5-28. A9 Option 003 Channel C Adjustment	5-13
VI	REPLACEABLE PARTS	6-1
	6-1. Introduction	6-1
	6-3. Abbreviations	6-1
	6-5. Replaceable Parts	6-1
	6-9. Ordering Information	6-1
	6-12. Direct Mail Order System	6-3
	6-15. Special Parts Replacement Considerations	6-3
VII	MANUAL CHANGES	7-1
	7-1. Introduction	7-1
	7-3. Manual Changes	7-1
	7-5. Newer Instruments	7-1
	7-7. Older Instruments	7-1

TABLE OF CONTENTS (Continued)

Section	Title	Page
VIII	SERVICE	8-1
8-1.	Introduction	8-1
8-3.	Theory of Operation	8-1
8-5.	Troubleshooting	8-1
8-8.	Recommended Test Equipment	8-1
8-10.	Schematic Diagram Notes	8-1
8-12.	Reference Designations	8-1
8-14.	Identification Markings on Printed Circuit Boards	8-3
8-17.	Safety Considerations	8-3
8-22.	Service Aids	8-4
8-23.	Pozidriv Screwdrivers	8-4
8-25.	Service Aids on Printed Circuit Boards	8-4
8-28.	Theory of Operation	8-5
8-29.	Signal Mnemonics	8-5
8-31.	Introduction	8-5
8-33.	Block Theory	8-5
8-35.	Overall Theory	8-6
8-40.	Troubleshooting	8-13
8-43.	Preliminary Troubleshooting	8-13
8-46.	Main Counter Theory	8-21
8-54.	Main Counter Troubleshooting	8-21
8-56.	HP-IB Theory (Remote Control)	8-22
8-69.	Signature Analysis Troubleshooting	8-23
8-71.	Time Base Support and Injection-Locked Multiplier Theory	8-25
8-75.	Injection-Locked Multiplier Troubleshooting	8-25
8-78.	Power Supplies	8-26
8-86.	Power Supply Troubleshooting	8-27
8-88.	Channel A and B Theory	8-32
8-90.	A3 Input Switch Assembly	8-33
8-95.	A4 Input Amplifiers	8-33
8-99.	A3/A4 Input Amplifier Troubleshooting	8-34
8-101.	A9 Channel C Theory of Operation	8-38
8-107.	Channel C Troubleshooting	8-39
8-112.	A7 Time Base Oscillator	8-42
8-115.	Option 004 Oven Oscillator	8-42
8-117.	A7 Troubleshooting	8-42
8-122.	A6 Digital-to-Analog Converter	8-46
8-136.	A6 Digital-to-Analog Converter Troubleshooting	8-47
8-145.	A2/A5 Display Assembly	8-52
8-150.	A2 Display Troubleshooting	8-53
8-152.	A12 HP-IB Interface Assembly	8-54
8-158.	A12 HP-IB Interface Troubleshooting	8-54

LIST OF TABLES

Table	Title	Page
1-1.	Model 5316A Specifications	1-2
1-2.	Accessories Supplied	1-5
1-3.	Accessories Available	1-6
1-4.	Recommended Test Equipment	1-6
2-1.	Options 001, 004, and 003 Parts List	2-4
3-1.	Display Check	3-7
3-2.	HP-IB Interface Functions	3-29
3-3.	Bus Messages	3-31
3-4.	Address Selection	3-33
3-5.	Output String Format	3-37
3-6.	HP-IB Program Code Set	3-39
4-1.	Operational Verification	4-2
4-2.	5316A In-Cabinet Performance Test	4-5
4-3.	HP-IB Verification	4-13
4-4.	5316A HP-IB Verification Program	4-17
5-1.	Adjustments	5-1
6-1.	Reference Designations and Abbreviations	6-2
6-2.	Replaceable Parts List	6-5
6-3.	Mechanical Parts List	6-18
6-4.	5316A Hardware	6-21
6-5.	Manufacturers Code List	6-22
7-1.	Manual Backdating	7-1
8-1.	5316A Assembly Reference Designators	8-5
8-2.	Mnemonics	8-6

LIST OF FIGURES

Figure	Title	Page
1-1.	Model 5316A Universal Counter and Power Cable	1-0
2-1.	5316A Line Voltage Selection	2-2
2-2.	Power Cable HP Part Numbers versus Main Plugs Available	2-3
3-1.	T.I. Average Dead Time	3-2
3-2.	T.I. Delay	3-3
3-3.	Totalize A BY B	3-4
3-4.	A Armed BY B	3-5
3-5.	Trigger Level/Sensitivity Control	3-8
3-6.	Input Amplifier Block Diagram	3-9
3-7.	AC Coupled Measurements	3-11
3-8.	DC Coupled Measurements	3-12
3-9.	Details of Input Connector J1 and Fuse Mounting	3-14
3-10.	Front Panel Features	3-15
3-11.	5316A Rear Panel Features	3-18
3-12.	Operator's Check	3-19
3-13.	Frequency A/Period A Measurements	3-20
3-14.	Time Interval Measurement	3-21
3-15.	Time Interval Delay Measurement	3-22
3-16.	Time Interval Average A→B	3-23
3-17.	Ratio A/B Measurements	3-24
3-18.	A BY B Measurements	3-25
3-19.	FREQ A Armed by B Measurements	3-26
3-20.	Totalize Measurements	3-27
3-21.	Frequency C Measurements	3-28
3-22.	5316A Address Switches (20)	3-32
4-1.	Channel C Test Setup	4-11
5-1.	Power Supply Adjustment Location	5-2
5-2.	A4 Offset Adjustment Location	5-3
5-3.	Digital-to-Analog Converter Adjustment Location	5-4
5-4.	Trigger Level Gain Compensation Adjustment Location	5-6
5-5.	Injection-Locked Multiplier Adjustment Location	5-8
5-6.	Internal Time Base Adjustment Location	5-9
5-7.	TCXO Option 001 Adjustment Location	5-11
5-8.	Option 004 Oven Oscillator Adjustment Location	5-12
5-9.	Channel C Adjustment Location	5-14
6-1.	Model 5316A Mechanical Parts Layout	6-19
6-2.	Model 5316A Mechanical Parts Layout	6-20
8-1.	Schematic Diagram Notes	8-2
8-2.	Overall Block Diagram	8-11
8-3.	Troubleshooting Flowchart	8-17
8-4.	Troubleshooting Block Diagram	8-19
8-5.	A1 Motherboard (Counter Portion) (Sheet 1 of 2)	8-29
8-5.	A1 Motherboard (HP-IB) (Sheet 2 of 2)	8-31
8-6.	A3/A4 Input Assembly	8-37
8-7.	A9 Channel C Assembly	8-41
8-8.	A7 Time Base Assemblies	8-45
8-9.	A6 Digital-to-Analog Converter Assembly	8-51
8-10.	A2/A5 Display Assembly	8-53
8-11.	A12 HP-IB Interface Assembly	8-55

PREFACE

This manual is designed to present the information required by the user to effectively operate and maintain the 5316A Universal Counter.

It is divided into sections, each relating to a specific topic. As much as possible the sections are self-contained. It is the intention of this manual to allow for the quick location of desired information, while still providing the overall depth of detail required. Some sections provide the learning and working information, and will be used frequently. Other sections are dedicated to general and introductory types of information, and are intended to be used only for reference. Where applicable, photos, illustrations, and diagrams foldout allowing the user access to related information throughout the manual.

In limiting the depth of coverage in this manual, a certain amount of previous knowledge on the part of the reader must be assumed. A variety of additional related documentation is available. These materials address in depth the specific areas of interest, and should be used, whenever necessary, to supplement this manual. Users unfamiliar with HP-IB or Logic Symbology, for example, may want to refer to the 5316A Documentation Map to find additional sources of information.

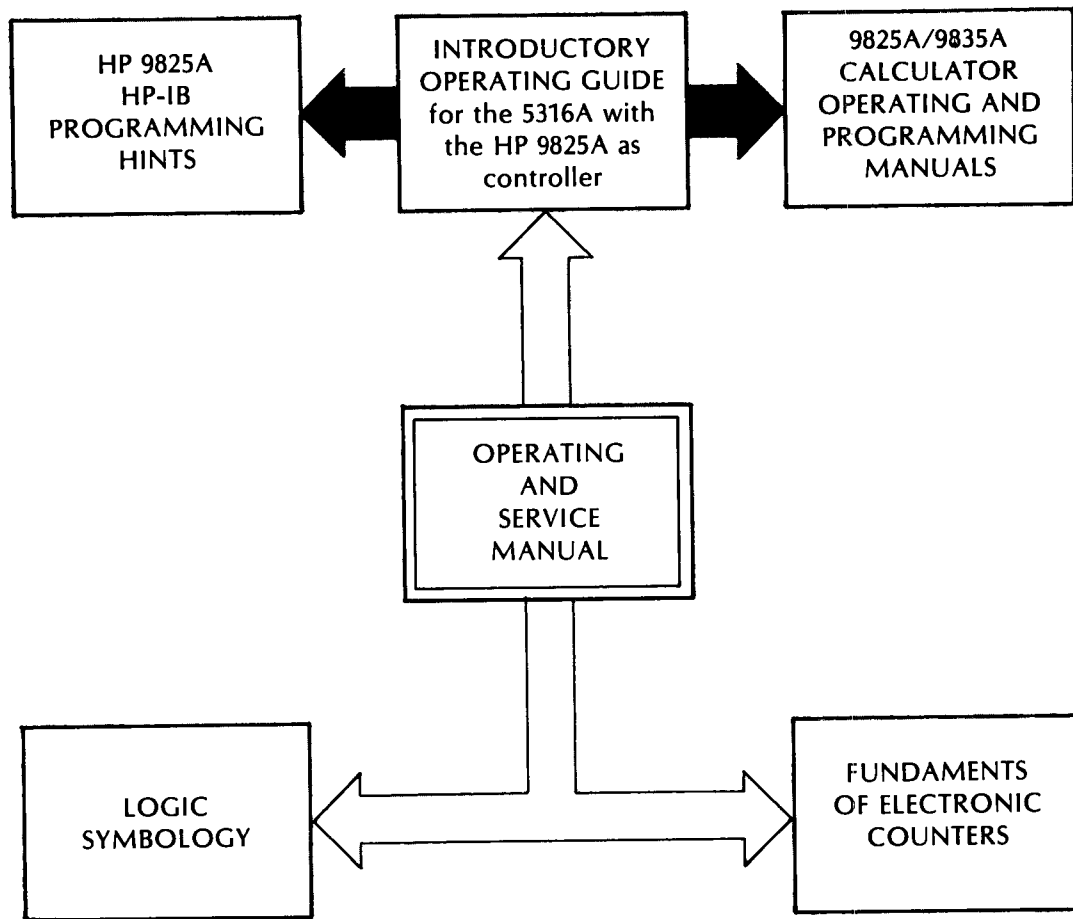

5316A/9825A INTRODUCTORY OPERATING GUIDE — Provides basic HP-IB interconnection information, remote programming examples and applications; specifically for the HP 5316A Universal Counter, using the HP 9825A as controller.

5316A OPERATING AND SERVICE MANUAL — Provides primary operating instructions and service information.

FUNDAMENTALS OF ELECTRONIC COUNTERS (AN 200) — Provides the basic concepts, techniques and underlying principles of electronic counters.

HP LOGIC SYMBOLOGY TRAINING MANUAL — Instructional training and definition of new Logic Symbology.

HP 9825A HP-IB PROGRAMMING HINTS — Includes a variety of HP-IB related documents, including general bus theory and instrument specific programming examples.

9825A/9835A OPERATING AND PROGRAMMING MANUALS — Provides programming instructions for the 9825A and 9835A calculators — (Two separate manuals).

SAFETY CONSIDERATIONS

GENERAL

This is a Safety Class I instrument. This instrument has been designed and tested according to IEC Publication 348, "Safety Requirements for Electronic Measuring Apparatus".

This manual contains information, cautions, and warnings which must be followed by the service person to ensure safe operation and to retain the instrument in safe condition.

WARNINGS

SAFETY

If this instrument is to be energized via an autotransformer for voltage reduction, make sure the common terminal is connected to the earthed pole of the power source.

BEFORE SWITCHING ON THIS INSTRUMENT, the protective earth terminals of this instrument must be connected to the protective conductor of the (mains) power cord. The mains plug shall only be inserted in a socket outlet provided with a protective earth contact. The protective action must not be negated by the use of an extension cord (power cable) without a protective conductor (grounding).

Make sure that only fuses with the required rated current and of the specified type (normal blow, time delay, etc.) are used for replacement. The use of repaired fuses and the short-circuiting of fuse holders must be avoided.

Whenever it is likely that the protection offered by fuses has been impaired, the instrument must be made inoperative and be secured against any unintended operation.

GROUNDING

Any interruption of the protective (grounding) conductor (inside or outside the instrument) or disconnecting the protective earth terminal is likely to make this instrument dangerous. Intentional interruption is prohibited.

HIGH VOLTAGE

Warning — These servicing instructions are for use by qualified personnel only. To avoid dangerous electric shock, do not perform any servicing other than that contained in the operating instructions unless you are qualified to do so.

CAUTIONS

LINE VOLTAGE SELECTION

BEFORE SWITCHING ON THIS INSTRUMENT, make sure the instrument is set to the voltage of the power source. Verify that the power module is matched to the available line voltage. Verify that the correct fuse is installed.

GROUNDING

BEFORE SWITCHING ON THIS INSTRUMENT, ensure that all devices connected to this instrument are connected to the protective (earth) ground. (Grounding one conductor of a two-conductor outlet is not sufficient.)

ATTENTION

This symbol: , which appears on the instrument means: Read the instruction manual before operating the instrument. If the instrument is operated without reading the instructions, it may not operate correctly.

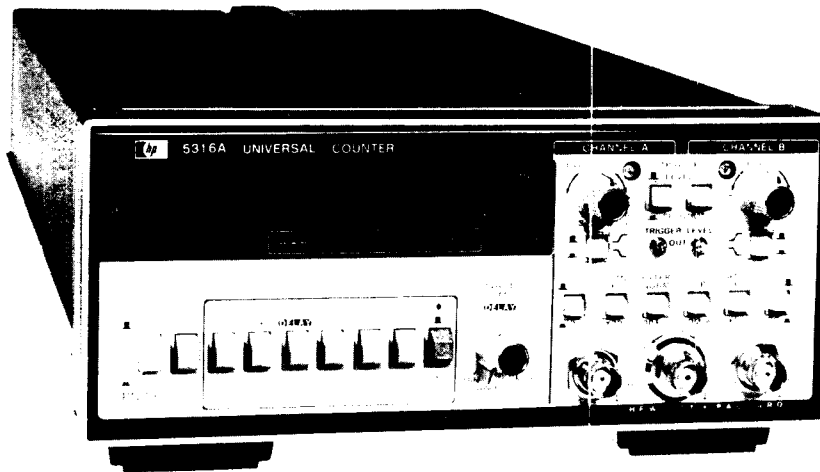

5316A UNIVERSAL COUNTER

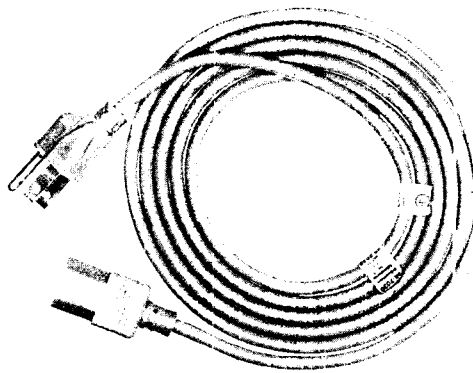

**POWER CORD
PART NO. 8120-1378**

Figure 1-1. Model 5316A Universal Counter and Power Cable

SECTION I GENERAL INFORMATION

1-1. INTRODUCTION

1-2. This manual provides information pertaining to the installation, operation, programming, testing, adjustments, and maintenance of the HP Model 5316A Universal Counter, shown in *Figure 1-1*.

1-3. This manual is divided into eight sections, each covering a particular topic for the operation of the HP Model 5316A Universal Counter. The topics by section number are:

Section	Topic
I	General Information
II	Installation
III	Operation and Programming
IV	Performance Tests
V	Adjustments
VI	Replaceable Parts
VII	Manual Changes
VIII	Service

A three-section users manual is provided with the 5316A. These three sections duplicate the first three sections of the eight-section manual. We suggest that you keep the users manual with the 5316A.

1-4. DESCRIPTION

1-5. The Hewlett-Packard Model 5316A is a universal counter, measuring signals over a range of DC to 100 MHz. The 5316A measures Frequency, Period, Time Interval, Time Interval Average, Time Interval Holdoff (delay), and Ratio. A Totalize function with manual or external gating is also provided. All measurements except Totalize are displayed in engineering notation with up to eight digits of resolution. In addition, the 5316A may be programmed via the Hewlett Packard Interface Bus (HP-IB).

1-6. Two independent input channels are provided for time interval measurements. Each input channel has an Attenuator (X1, X20), Trigger Slope selector, Trigger Level/Sensitivity control, three-state trigger lamps, and front panel Trigger Level Monitoring jacks. A front panel selectable Low-Pass Filter is provided for Channel A.

1-7. Four options extend the capabilities of the 5316A. Option 001 TCXO and Option 004 Oven Oscillator offer improved time base stability. Option 003 Channel C allows frequency measurements in the range of 50 MHz to 1 GHz. Option 006 Offset/Normalizer allows active mathematical modifications to the 5316A display. Complete specifications are given in *Table 1-1*.

1-8. The 5316A is designed for rack mounting or stacking and features a metal cabinet to minimize EMI.

1-9. SPECIFICATIONS

1-10. The instrument specifications are listed in *Table 1-1*. These specifications are the performance standards or limits against which the instrument may be tested.

Table 1-1. Model 5316A Specifications

**INPUT CHARACTERISTICS
(Channel A and Channel B)**

Range:

DC coupled, 0 to 100 MHz.
AC coupled, 30 Hz to 100 MHz.

Sensitivity:

10 mV rms sine wave to 10 MHz.
25 mV rms sine wave to 100 MHz.
75 mV peak-to-peak pulse at minimum pulse width of 5 ns.
Sensitivity can be varied continuously up to 500 mV rms
NOMINAL by adjusting sensitivity control. In sensitivity
mode, trigger level is automatically set to 0V **NOMINAL**.

Dynamic Range:

30 mV to 5V peak-to-peak, 0 to 10 MHz.
75 mV to 5V peak-to-peak, 10 to 100 MHz.

Signal Operating Range: +2.5V dc to -2.5V dc.

Coupling: AC or DC, switchable.

Filter: Low pass, switchable in or out of Channel A.
3 dB point of **NOMINALLY** 100 kHz.

Impedance:

1 MΩ **NOMINAL** shunted by less than 40 pF.

Attenuator: X1 or X20 **NOMINAL**.

Trigger Level: Variable between +2.5V dc and -2.5V dc.

Slope: Independent selection of + or - slope.

Common Input: All specifications are the same for Common A
except the following:

- Sensitivity: 20 mV rms sine wave to 10 MHz.
50 mV rms sine wave to 100 MHz, 150 mV peak-to-peak.
- Dynamic Range: 60 mV to 5V peak-to-peak 0-10 MHz,
150 mV to 5V peak-to-peak 10-100 MHz.
- Impedance: 500 kΩ **NOMINAL** shunted by less than 70 pF.

Damage Level:

- AC & DC × 1:
 - DC to 2.4 kHz 250V (DC + AC rms)
 - 2.4 kHz to 100 kHz (6 × 10⁵V rms × Hz)/FREQ
 - >100 kHz 6V rms
- AC & DC × 20:
 - DC to 28 kHz 500V (DC + AC peak)
 - 28 kHz to 100 kHz (1 × 10⁷V rms × Hz)/FREQ
 - >100 kHz 100V rms

FREQUENCY (Channel A)

Range: .1 Hz to 100 MHz.

LSD Displayed: 10 Hz to 1 nHz depending upon gate
time and input signal. At least 7 digits displayed per
second of gate time.

Resolution:

For FREQ < 10 MHz;

$$\pm \text{LSD} \pm 1.4 \times \frac{\text{Trigger Error}}{\text{Gate Time}} \times \text{FREQ.}$$

For FREQ ≥ 10 MHz; ±LSD††

Accuracy: ± Resolution ± (time base error) × FREQ.

RATIO

Range: .1 Hz to 100 MHz, both channels.

LSD:

$$\frac{2.5 \times \text{Period}}{\text{Gate Time}} \times \text{Ratio (rounded to nearest decade).}$$

where "Period" is the period of the highest frequency
input signal.

Resolution:

FREQ A > FREQ B

$$\pm \text{LSD} \pm \frac{\text{B Trigger Error}}{\text{Gate Time}} \times \text{Ratio.}$$

FREQ B > FREQ A

$$A = \frac{2.5 \times \text{Period A}}{\text{Gate Time}} \times \text{Ratio}$$

(Rounded to nearest decade)

$$\pm A \pm \frac{\text{B Trigger Error}}{\text{Gate Time}} \times \text{Ratio}$$

Accuracy: Same as resolution.

TOTALIZE

Manual:

Range: 0 to 100 MHz.

A Gated By B:

Totalizes input A between two events of B. Instrument must be
reset to make new measurement. Gate opens on A slope, closes
on B slope.

Range: 0 to 100 MHz.

Resolution: ±1 count.

Accuracy: ±1 count ± B Trigger Error × Frequency A.

PERIOD

Range: 10 ns to 10⁵ s.

LSD Displayed: 100 ns to 1 fs depending upon gate time and
input signal. At least 7 digits displayed per second of
gate time.

Resolution:

For PER > 100 ns;

$$\pm \text{LSD} \pm 1.4 \times \frac{\text{Trigger Error}}{\text{Gate Time}} \times \text{PER.}$$

For PER ≤ 100 ns; ±LSD††

Accuracy: ± Resolution ± (time base error) × PER.

†Best Case Resolution for 1 Second Gate

	100 Hz	1 kHz	10 kHz	100 kHz	1 MHz	10 MHz	100 MHz
50 mV rms	±0.004 Hz	±0.0048 Hz	±0.014 Hz	±0.1 Hz	±1 Hz	±1 Hz	±10 Hz
100 mV rms	±0.002 Hz	±0.0029 Hz	±0.012 Hz	±0.1 Hz	±1 Hz	±1 Hz	±10 Hz
500 mV rms	±0.0005 Hz	±0.0014 Hz	±0.011 Hz	±0.1 Hz	±1 Hz	±1 Hz	±10 Hz
1V rms	±0.0003 Hz	±0.0012 Hz	±0.010 Hz	±0.1 Hz	±1 Hz	±1 Hz	±10 Hz

This chart shows best case frequency resolution versus input sine wave rms amplitude.
This is best case because noise from the signal source is assumed to be zero; the trigger
error is produced only by the counter's noise (i.e., 120 μV rms).

††Due to arithmetic truncation, quantization error will be ±1 or ±2 counts of the
LSD (Least Significant Digit) as follows:

$$\pm 2 \text{ counts of LSD if } \frac{\text{LSD}}{\text{FREQ or PER}} < 1 \times 10^{-7}, \text{ FREQ} < 10 \text{ MHz.}$$

$$\pm 2 \text{ counts of LSD if } \frac{\text{LSD}}{\text{FREQ or PER}} < \frac{1}{\text{Gate Time}}, \text{ FREQ} \geq 10 \text{ MHz.}$$

±1 count of LSD for all other cases.

Table 1-1. Model 5316A Specifications (Continued)

TIME INTERVAL

Range: 100 ns to 10⁵ s.
LSD Displayed: 100 ns.
Resolution: ± LSD ± Start Trigger Error ± Stop Trigger Error.
Accuracy: ± Resolution ± (time base error) × T.I.

TIME INTERVAL AVERAGE

Range: 0 ns to 10⁵ s.
LSD Displayed: 100 ns to 10 ps depending upon gate time and input signal. See table in Definitions section.
Resolution:

$$\pm \text{LSD} \pm \frac{\text{Start Trigger Error}}{\sqrt{N}} \pm \frac{\text{Stop Trigger Error}}{\sqrt{N}}$$

Accuracy: ± Resolution ± (time base error) × T.I. ± 4 ns.
Number of Intervals Averaged (N): N = Gate Time × FREQ
Minimum Dead Time (stop to start): 200 ns.

TIME INTERVAL DELAY (Holdoff)

Front panel gate time knob inserts a variable delay of **NOMINALLY** 500 μs to 20 ms between START (Channel A) and enabling of STOP (Channel B). Electrical inputs during delay time are ignored. Delay time may be measured by simultaneously pressing T.I. Average, T.I. Delay, and Blue Shift key. Other specifications of T.I. Delay are identical to Time Interval.

TIME BASE

Frequency: 10 MHz.
Aging Rate: <3 × 10⁻⁷/mo.
Temperature: ≤5 × 10⁻⁶, 0 to 50°C.
Line Voltage: ≤1 × 10⁻⁷ for ±10% variation.
Oscillator Output: 10 MHz, 50 mV p-p into 50Ω.
External Frequency Standard Input: 1, 5, 10 MHz, 1V rms into 500Ω, on rear panel; 6V rms maximum.

GENERAL

Trigger Level Output: ±5% ±15 mV, over ±2.0V dc range at front panel test connectors.
Check: Counts internal 10 MHz reference frequency over gate time range **NOMINALLY** 500 μs to 30 ms.
Error Light: LED warning light activated if logic error is found during instrument turn-on self-check.
Display: 8-digit LED display, with engineering units annunciator.
Overflow: Only frequency and totalize measurements will overflow. In case of overflow, eight least significant digits will be displayed and front panel overflow LED will be actuated. All other measurements which would theoretically cause a display of more than eight digits will result in the display of the eight most significant digits.
Gate Time: Continuously variable, **NOMINALLY** from 60 ms to 10 s or 1 period of the input, whichever is longer. For FREQ A, a shorter gate time of 500 μs–30 ms is selectable by simultaneously pressing T.I. Delay and Totalize keys.
Sample Rate: Up to seven readings per second **NOMINAL** except in time interval mode, where it is continuously variable **NOMINALLY** from four readings per second to 1 reading every 10 seconds via Gate Time control.
Operating Temperature: 0° to 50°C.
Power Requirements: Selectable 100, 120, 220, or 240V (+5%, -10%) 48–66 Hz; 30 VA maximum.
Dimensions: 212 mm W × 88 mm H × 415 mm D (8 3/8 × 3 1/2 × 16 1/2 in.).

Weight: Net, 3.9 kg (8 lbs. 10 oz.); Shipping, 6.3 kg (14 lbs.). Rack and stack metal case with rear panel, switchable AC power line module.
Rack Mount Kit: 5061-0072 recommended.

HP INTERFACE BUS (HP-IB)

Data Output
Format: (alpha character) ± (Reading) (Exponent) ± (2 digits).
Data Output Rate: ~7 Readings/second max. (10 in short G.T.)
Talk Only Mode: Selectable by rear panel switch.
Operating Commands
5316A: Reset, Initialize (to FREQ A), Wait State ON/OFF, Service Request Enabled/Disabled, Gate Time Range.
HP-IB: Group Execute Trigger, Device Clear, Selected Device Clear, Interface Clear, Local, Remote, Local Lockout, Read Status (Serial Poll Enable).
Programmable Controls and Functions
Frequency Functions: FREQUENCY A, FREQ A ARMED BY B, TOTALIZE, A GATED BY B, RATIO A/B, and FREQ C.
Period Function: Period A.
Time Interval Functions: Time Interval A–B, Time Interval Average A–B, Time Interval Delay.
Trigger Level Commands: Set Channel A Slope (±), set Channel B Slope (±), A Trigger Level: ±X.XX, B Trigger Level: ±X.XX.
Gate Time Command: Sets Gate Time Range.
Miscellaneous Functions: Gate Time Check, Display Test, 10 MHz Check, Interface Test.

OPTIONS

OPTION 001: High Stability Time Base (TCXO)
Frequency: 10 MHz.
Aging Rate: <1 × 10⁻⁷/mo.
Temperature: <1 × 10⁻⁶, 0° to 40°C.
Line Voltage: <1 × 10⁻⁸ for ±10% variation.
OPTION 003: C Channel
Input Characteristics
Range: 50 to 1000 MHz, prescaled by 10.
Sensitivity: 15 mV rms sine wave (-23.5 dBm) to 650 MHz. 75 mV rms sine wave (-9.5 dBm) to 1000 MHz. Sensitivity can be decreased continuously by up to 20 dB **NOMINAL**, 50 to 500 MHz and 10 dB **NOMINAL**, 500 to 1000 MHz by adjusting sensitivity control. Trigger level is fixed at 0V **NOMINAL**.
Dynamic Range:
15 mV to 1V rms (36 dB), 50 to 650 MHz.
75 mV to 1V rms (20 dB), 650 to 1000 MHz.
Signal Operating Range: +5V dc to -5V dc.
Coupling: AC
Impedance: 50Ω **NOMINAL (VSWR, 12.5:1 TYPICAL)**.
Damage Level: ±8V (DC + AC peak), fuse protected. Fuse located in BNC connector.
Frequency
Range: 50 to 1000 MHz.
LSD Displayed: 100 Hz to 1 Hz depending upon gate time. At least 7 digits per second of gate time.
LSD, Resolution and Accuracy: Same formulas as for Frequency A except “Gate Time” term becomes “(Gate Time)/10”.

Table 1-1. Model 5316A Specifications (Continued)

OPTIONS (Continued)

OPTION 004: Oven Oscillator

Frequency: 10 MHz.

Aging Rate: $<5 \times 10^{-8}$ /month after 7 days of continuous operation. $<3 \times 10^{-7}$ /year after 180 days continuous operation.

Warm-up: $\pm 5 \times 10^{-8}$ of final value after 20 minutes.

Temperature: $\pm 2 \times 10^{-8}$, 0° to 50°C.

Oscillator Output: 50 mV p-p into 50Ω.

DEFINITIONS:

Resolution: Smallest discernible change of measurement result due to a minimum change in the input.

Accuracy: Deviation from the actual value as fixed by universally accepted standards of frequency and time.

Least Significant Digit (LSD) Displayed:

Frequency:

$$\frac{2.5 \times 10^{-7}}{\text{Gate Time}} \times \text{FREQ, for FREQ} < 10 \text{ MHz.}$$

$$\frac{2.5}{\text{Gate Time}} \quad \text{for FREQ} \geq 10 \text{ MHz.}$$

Period:

$$\frac{2.5 \times 10^{-7}}{\text{Gate Time}} \times \text{PER, for PER} > 100 \text{ ns.}$$

$$\frac{2.5}{\text{Gate Time}} \times \text{PER}^2, \text{ for PER} \leq 100 \text{ ns.}$$

All above calculations should be rounded to nearest decade (i.e., 5 Hz will become 10 Hz and .4 ns will be .1 ns).

NOTE

Time Interval Average is a statistical process. LSD displayed is calculated for 1 standard deviation (σ) confidence level.

Trigger Error:

$$\frac{\sqrt{(120 \times 10^{-6})^2 + e_n^2}}{\text{(Input slew rate in V/s at trigger point)}} \text{ seconds rms,}$$

Typical where e_n is the rms noise voltage of the input for a 100 MHz bandwidth.

Time Interval Average:

	LSD
1 to 25 intervals	100 ns
25 to 2500 intervals	10 ns
2500 to 250,000	1 ns
250,000 to 25,000,000 intervals	100 ps
>25,000,000 intervals	10 ps

1-11. OPTIONS

1-12. The options available for the 5316A are listed below. There are no field retrofit kits available for these options. All options should be requested at the time of the initial order. However, Section II contains the necessary information required to install Option 001 TCXO, Option 004 Oven Oscillator, and Option 003, Channel C. Options 001 and 004 requires the standard A7 assembly be replaced by the appropriate option (Option 004 adds an A13 assembly). Option 003 requires the addition of the A9 assembly and a new front panel. All parts must be ordered as separate items and then installed as described in Section II. Option 006 is described in its own manual. Full descriptions of Options 001, 003, and 004 begin with paragraph 3-62.

Option	Description
001	High Stability Time Base (TCXO)
003	Channel C 1 GHz
004	Oven Oscillator
006	Offset/Normalizer

1-13. Option 001 TCXO is a Temperature Compensated Crystal Oscillator that directly replaces the standard A7 oscillator assembly. Option 004 Oven Oscillator provide increased temperature stability over the TCXO. Specifications are listed in *Table 1-1*.

1-14. Option 003 Channel C allows frequency measurements to 1 GHz. Specifications are listed in *Table 1-1*.

1-15. Option 006 Offset/Normalizer allows the operator to make active mathematical modifications to the display of the 5316A. Option 006 is described in its own operation and service manual, HP Part Number 05315-90011, plus Addendum 05315-90019.

1-16. SAFETY CONSIDERATIONS

1-17. The 5316A Universal Counter is a Safety Class I instrument, designed according to International Safety Standards. This operating manual contains information, cautions, and warnings which must be followed by the user to ensure safe operation and keep the instrument in safe condition.

1-18. INSTRUMENT IDENTIFICATION

1-19. Hewlett-Packard instruments have a 2-section, 10-character serial number (0000A00000), which is located on the rear panel. The four-digit serial prefix identifies instrument changes. If the serial prefix of your instrument differs from that listed on the title page of this manual, there are differences between this manual and your instrument. Instruments having higher serial prefixes are covered with a "Manual Changes" sheet included with this manual. If the change sheet is missing, contact the nearest Hewlett-Packard Sales and Service Office listed at the back of this manual. Instruments having a lower serial prefix than that listed on the title page are covered in Section VII.

1-20. ACCESSORIES

1-21. *Table 1-2* lists accessory equipment supplied and *Table 1-3* lists accessories available.

Table 1-2. Accessories Supplied

Description	HP Part Number
Detachable Power Cord, 229 cm (7½ feet)	8120-1378

Table 1-3. Accessories Available

Description	HP Part Number
Rack Mount Kit	5061-0072

1-22. RECOMMENDED TEST EQUIPMENT

1-23. The test equipment listed in *Table 1-4* is recommended for use during performance tests, adjustments, and troubleshooting. Substitute test equipment may be used if it meets the required characteristics listed in the table.

Table 1-4. Recommended Test Equipment

Instrument	Critical Specifications	Recommended Model	Use*
Oscilloscope	100 MHz Bandwidth	HP 1740A	P,A,T
Synthesizer/Generator	0.1—10 MHz	HP 3325A	P,A,T
Signal Generator	10—100 MHz	HP 8654A	P,A,T
Synthesized Generator	1000 MHz	HP 8660C/86602A	P,A,T
DC Voltmeter	20V Range, 0.05V Resolution	HP 3465A	P,A,T
Counter	10 MHz, .1 Hz Resolution	HP 5345A	A
50Ω Feedthrough	BNC Type	HP 10100C	P,A,T
Tee Connector	BNC Type	HP 1250-0781	P,A,T
Power Splitter	DC—18 GHz	HP 11667A	P
Cables (3)	4 BNC 50Ω	HP 11170C	P,A,T
Controller	IEEE 488-1978	HP 9825A/B	P,A,T,
Signature Analyzer		HP 5004A/5005A	T

*P = Performance Tests, A = Adjustments, T = Troubleshooting.

**9825A requires the 98210A Advanced Programming-String Variable ROM, the 98213A/14A or 16A General Extended I/O ROM, and a 98034A HP-IB Interface Card. A 9825B and 98034A may be used in place of the above system.

SECTION II INSTALLATION

2-1. INTRODUCTION

2-2. This section contains information for unpacking, inspection, storage, and installation.

2-3. UNPACKING AND INSPECTION

2-4. If the shipping carton is damaged, inspect the instrument for visible damage (scratches, dents, etc.). If the instrument is damaged, notify the carrier and the nearest Hewlett-Packard Sales and Service Office immediately (offices are listed at the back of this manual.) Keep the shipping carton and packing material for the carrier's inspection. The Hewlett-Packard Sales and Service Office will arrange for repair or replacement of your instrument without waiting for the claim against the carrier to be settled.

2-5. PREPARATION FOR USE

2-6. Power Requirements

2-7. The HP 5316A requires a power source of 100-, 120-, 220-, or 240-volt ac, +5%, -10%, 48 to 66 Hz single phase. Power consumption is approximately 15 watts. See Section I, Specifications for description.

2-8. Line Voltage Selection

CAUTION

Before connecting the instrument to ac power lines, be sure that the voltage selector is properly positioned as described below.

2-9. The 5316A is equipped with a power connector module that has a plug-in printed-circuit card line voltage selector to choose 100-, 120-, 220-, or 240-volt ac operation (see *Figure 2-1*). Before applying power, the selector card must be set to the correct position and the correct fuse must be installed as described below.

2-10. Power line connections are selected by the position of the plug-in card in the module. When the card is plugged into the module, the only visible markings on the card indicate the line voltage to be used. The correct value of line fuse, with 250-volt rating, must be installed after the card is inserted.

2-11. To convert from one line voltage to another, the power cord must be disconnected from the power module before the sliding window covering the fuse and card compartment can be moved to expose the fuse and circuit card.

2-12. Pull on the fuse lever to remove the fuse and then pull the card out of the module. The fuse lever must be held to one side to remove and insert the card. Insert the card so the marking that agrees with the line voltage to be used is visible.

2-13. Return fuse lever to normal position, insert correct fuse, slide plastic window over the compartment, and connect the power cord to complete the conversion.

NOTE

For operation from 100V ac or 120V ac use a .3A slo-blo fuse. For 220V ac or 240V ac operation, use a .15A slo-blo fuse.

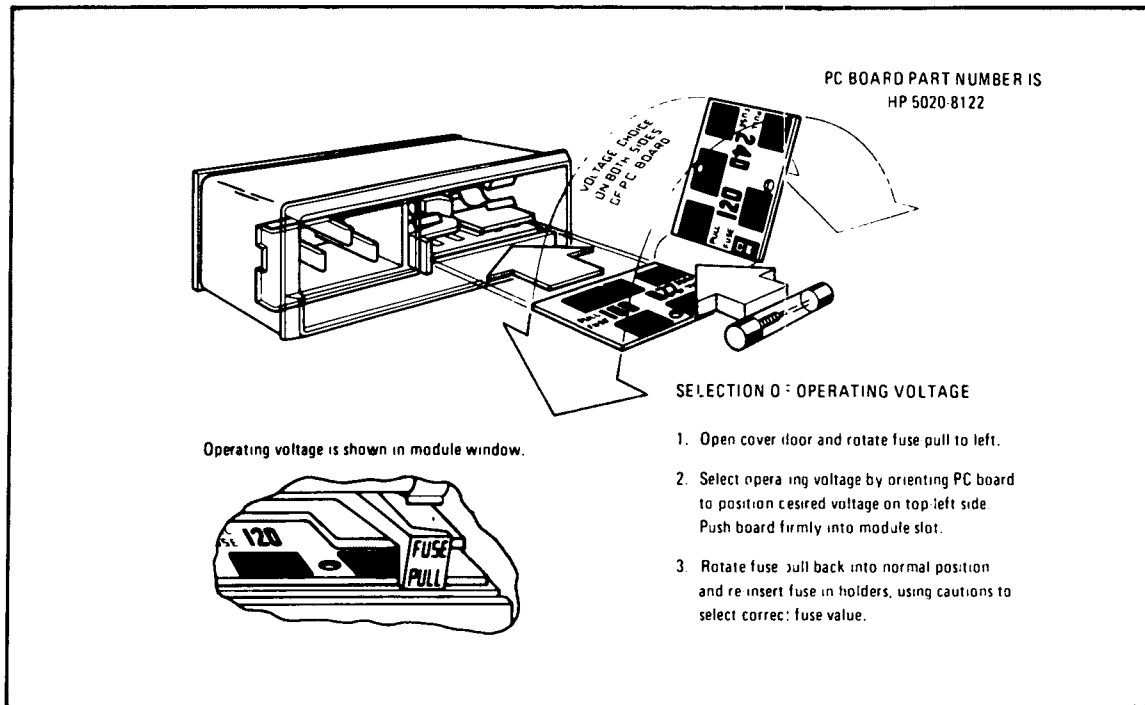

Figure 2-1. 5316A Line Voltage Selection

2-14. Power Cable

WARNING

BEFORE CONNECTING ELECTRIC POWER TO THIS INSTRUMENT, THE PROTECTIVE EARTH TERMINALS OF THIS INSTRUMENT MUST BE CONNECTED TO THE PROTECTIVE CONDUCTOR OF THE (MAINS) POWER CORD. THE MAIN PLUG SHALL ONLY BE INSERTED IN A SOCKET OUTLET PROVIDED WITH A PROTECTIVE EARTH CONTACT. THE PROTECTIVE ACTION MUST NOT BE NEGATED BY THE USE OF AN EXTENSION CORD (POWER CABLE) WITHOUT A PROTECTIVE CONDUCTOR (GROUNDING).

2-15. The 5316A is shipped with a three-wire power cable. When the cable is connected to an appropriate ac power source, this cable connects the chassis to earth ground. The type of power cable plug shipped with each instrument depends on the country of destination. Refer to Figure 2-2 for the part numbers of the power cable and plug configurations available.

2-16. Operating Environment

2-17. TEMPERATURE. The 5316A may be operated in temperatures from 0°C to 50°C.

2-18. ALTITUDE. The 5316A may be operated at altitudes up to 4,600 metres (15,000 feet).

2-19. STORAGE AND SHIPMENT

2-20. Environment

2-21. The instrument may be stored or shipped in environments with the following limits:

Temperature	-40°C to +75°C
Altitude	7,620 metres (25,000 feet)

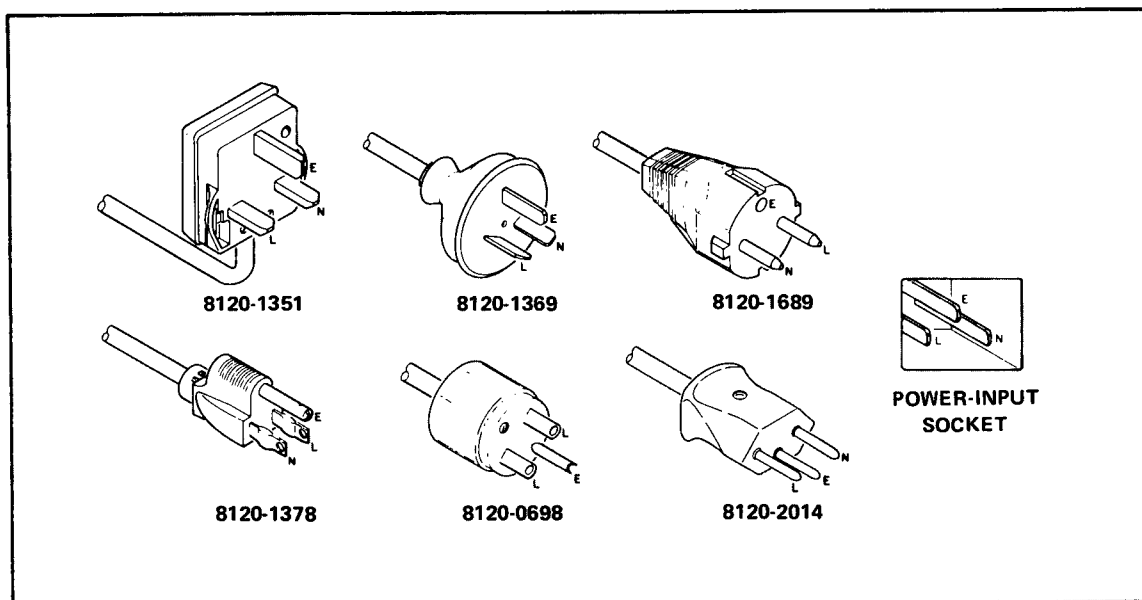

Figure 2-2. Power Cable HP Part Numbers versus Main Plugs Available

2-22. The instrument should also be protected from temperature extremes which cause condensation within the instrument.

2-23. Packaging

2-24. ORIGINAL PACKAGING. Containers and materials identical to those used in factory packaging are available through Hewlett-Packard offices. If the instrument is being returned to Hewlett-Packard for servicing, attach a tag indicating the type of service required, return address, model number, and full serial number. Also, mark the container FRAGILE to ensure careful handling. In any correspondence, refer to the instrument by model number and full serial number.

2-25. OTHER PACKAGING. The following general instruction should be used for repacking with commercially available materials:

- a. Wrap instrument in heavy paper or plastic. (If shipping to Hewlett-Packard office or service center, attach a tag indicating type of service required, return address, model number, and full serial number.)
- b. Use strong shipping container. A double-wall carton made of 350-pound test material is adequate.
- c. Use a layer of shock-absorbing material 70 to 100 mm (3- to 4-inch) thick around all sides of the instrument to provide firm cushioning and prevent movement inside container. Protect control panel with cardboard.
- d. Seal shipping container securely.
- e. Mark shipping container FRAGILE to ensure careful handling.
- f. In any correspondence, refer to instrument by model number and full serial number.

2-26. FIELD INSTALLATION OF OPTIONS

2-27. The following paragraphs provide instructions for the installation of Option 001 (TCXO), Option 004 (Oven Oscillator), and Option 003 (Channel C). Any of the options may be installed after the purchase of the 5316A by ordering the appropriate parts in *Table 2-1* and performing the installation procedure listed in paragraphs 2-30 through 2-35.

Table 2-1. Options 001, 004, and 003 Parts Lists

OPTON 001 TCXO	
A7 TCXO ASSEMBLY	05316-60007
OPTION 004 OVEN OSCILLATOR	
Oven Oscillator Assembly Kit	05316-60104
4-40 .187" Pan Head Pozidriv Screws (3 ea.)	2200-0179
6-32 .250" Pan Head Pozidriv Screws (3 ea.)	2360-0113
OPTION 003 CHANNEL C	
Special BNC Connector	05305-60205
Connector Body	05305-20104
Teflon Insulator	05305-20105
Hex Nut	0590-0038
Lockwasher	1250-0632
Connector	05305-60206
Fuse .125A	2110-0301
Front Panel	05316-00005
Channel C Assembly A9	05315-60009
Screws 6-32 X .250" Pan Head Pozidriv (4 ea.)	2360-0113

WARNING

TO PREVENT ELECTRICAL SHOCK, REMOVE ALL POWER FROM THE INSTRUMENT BEFORE REMOVING TOP COVER.

2-28. Part Numbers for Ordering Option Kits

2-29. To obtain the necessary parts for installation of an option, order by part number as listed in Table 2-1 (refer to Section VI for ordering information):

2-30. Option 001 TCXO Installation

2-31. Option 001 Temperature Compensated Crystal Oscillator (TCXO) replaces the standard reference oscillator which plugs into a connector (J10) on the A1 motherboard. To install Option 001, proceed as follows:

- a. Remove the AC power cord.
- b. Remove the top cover by removing the screw located at the rear top of the cover. This screw also secures the strap handle to the top cover. Slide the cover backward and remove.
- c. Remove the two Pozidriv screws securing the A7 standard reference oscillator to the A1 Motherboard.
- d. Remove the A7 standard reference oscillator.
- e. Insert the Option 001 TCXO into J10 located on the motherboard. This is the same jack previously occupied by the standard reference oscillator.
- f. Secure the Option 001 TCXO using the two posidriv screws previously securing the standard reference oscillator.
- g. Perform the "Operator's Checks" listed in Figure 3-12.
- h. Go to Section V, A7 Option 001 TCXO Adjustment, paragraph 5-22.
- i. Replace the top cover.

2-32. Option 004 Installation

2-33. Option 004 Oven oscillator consists of two sections, a voltage regulator assembly that replaces the standard A7 assembly and an oven oscillator module (A13) that is mounted to the left side frame. A cable connects the regulator assembly and the module to supply power to the oscillator and route the 10 MHz output back to the A1 Motherboard via the A7 regulator assembly. To install Option 004 Oven oscillator, proceed as follows:

- a. Remove the AC power cord.
- b. Remove the top cover by removing the screw located at the rear top of the cover. This screw also secures the strap handle to the top cover. Slide the cover backward and remove.
- c. Remove the bottom cover by rotating the screw located at the rear of the cover counterclockwise. As the screw is rotated the cover will begin to slide backwards and away from the rear frame. When the screw comes free, slide the cover backwards until it can be freely removed.
- d. Remove the two Pozidriv screws securing the standard A7 assembly to the A1 Motherboard.
- e. Remove the A7 assembly.
- f. Insert the A7 regulator assembly into J10 on the A1 Motherboard. This is the same jack previously occupied by the standard oscillator.
- g. Secure the A7 regulator assembly with the same screws previously securing the standard oscillator.
- h. Orient the oscillator module so the label is facing the front of the 5316A, the power supply and output pins are facing the rear, and the portion of the bracket that wraps around the module is against the left frame.
- i. Looking at the left frame of the 5316A, note the 17 holes that run along the top of the frame. Position the oscillator/bracket so the top two holes of the bracket align with the 7th and 9th holes of the frame, as counted from the rear of the 5316A. Note the hole at the bottom of the bracket aligns with the 9th hole as counted from the rear. Secure the bracket to the side frame with three (3) 6-32 1/4" screws. See *Figure 5-8*.
- j. Center trimmer A7R2 (located at the top of the regulator assembly).
- k. Apply power to the 5316A. Select the CHECK mode. Set the Gate Time control fully counterclockwise, but not HOLD.
- l. The 5316A should display 10 MHz with the Gate Lamp flashing. If this does not occur, remove power and check all connections. The most likely place for mistakes are the connections to the oscillator module. If all connections are correct, but the oscillator still does not operate, then go to Section VIII, Troubleshooting, for the Option 004 Oven Oscillator.
- m. If the 5316A is operating properly, go to Section V, Adjustments, for the Option 004 Oven Oscillator, paragraph 5-26.
- n. This completes the installation of the Option 004 Oven Oscillator.

2-34. Option 003 Channel C Installation

2-35. To install Option 003 proceed as follows:

- a. Remove the AC power cord.
- b. Remove the top cover by removing the screw located at the rear top of the cover. This screw also secures the strap handle to the top cover. Slide the cover backwards and remove.
- c. Disconnect the secondary of transformer T1 from the motherboard at J7. J7 is located in front of transformer T1.

- d. Remove the three screws on the right side frame of the instrument securing the support bracket (also a heat sink for the power supply regulators) and A6 Digital-to-Analog Converter to the right-side frame. Remove the cable connecting the A6 Digital-to-Analog Converter to the A3 Input Switch assembly. Remove the A6 Digital-to-Analog Converter.
- e. Remove the screw located at the front of the A12 HP-IB interface assembly securing this assembly to a spacer mounted to the A1 Motherboard.
- f. Remove the screw located at the lower center of the rear panel securing the A1 Motherboard to the rear panel.
- g. Remove the gray trim strip from the top of the front frame and remove the three screws securing the front panel to the front frame.
- h. Remove the three screws located on the bottom of the front frame securing the front panel to the front frame. The front two feet must be removed to access these screws.
- i. Disconnect the ribbon cable connecting the A12 HP-IB Interface to the A1 Motherboard (J8).
- j. On the rear panel, remove the nut securing the INT/EXT BNC to the rear panel.
- k. Remove the A1 Motherboard from the cabinet frame by gently pushing at the rear of the A4 Input Amplifier assembly and the heat sink until the motherboard can be freely removed.
- l. Remove the two LEVEL/SENS knobs and GATE TIME knob from the front panel.
- m. Remove the two ¼-inch nuts securing the trigger level nuts to the front panel.
- n. Remove the two hex nuts securing the CHANNEL A and CHANNEL B BNC's to the front panel.
- o. Remove the ¼-inch hex nut on the left-side (back) of the A2 assembly, and pull the front panel straight forward, until clear. Note the spacer between the front panel and the A2 assembly. Disconnect the two front panel trigger level slide-on connectors from A3.
- p. Remove the four Pozidriv screws securing the A4 assembly to the A1 Motherboard. Remove the combination A3/A4 assembly by gently lifting on the rear edge of the A4, until the pins come free of the A1 Motherboard Connector A1J4.
- q. Position the A9 Channel C assembly, component side up and protruding pins toward the rear of the instrument, over the A1 Motherboard Connector A1J3. Install by gently pressing the row of pins into connector A1J3 until the assembly rests on the spacers mounted on A1. Secure the A9 assembly with four Pozidriv screws (6-32 × .250").
- r. Install the special input BNC (supplied) in the INPUT C position (center) of the 5316A replacement front panel (supplied) as illustrated in Section III, *Figure 3-9*.
- s. Connect the brass SMC connector on A9W1 to the INPUT C BNC and tighten.
- t. Go to A9 Option 003 Channel C Adjustment, paragraph 5-28.
- u. Reassemble the instrument by essentially performing the reverse of steps a. through p.

SECTION III OPERATION

3-1. INTRODUCTION

3-2. This section provides operating information for the 5316A Universal Counter. Descriptions of all front panel controls, connectors, and indicators, as well as an operator's check, operating instructions, and operator's maintenance, are provided.

3-3. OPERATING CHARACTERISTICS

3-4. The 5316A is a 100 MHz/100 ns full universal counter, capable of Frequency, Period, Time Interval, Ratio, and Totalize measurements. To maximize resolution, the 5316A uses a reciprocal counting technique for frequencies below 10 MHz, automatically switching to conventional frequency counting for frequencies above 10 MHz. The gate time is continuously adjustable from 60 ms to 10 s, via the front panel. The internal microcomputer performs the calculations, and automatically takes into account the selected gate time. The display is given in engineering notation (i.e., exponents of blank, ± 3 , ± 6 , or ± 9 , except in totalize modes). The input amplifiers are optimized for both time interval and frequency measurements. In addition, the 5316A may be programmed via the HP-IB. The rear panel external reference input can accept 1, 5, or 10 MHz as the reference due to a time base multiplier (injection-lock-multiplier). With the addition of Option 001 TCXO or Option 004 Oven Oscillator, increased temperature stability is gained, and this increased stability allows extended calibration periods.

3-5. When Option 003 Channel C is installed, the frequency counting range of the counter is extended to 1 GHz. Signals on Input C are prescaled by 10, then routed to the Channel C input of the MRC (Multiple Register Counter) integrated circuit on the 5316A motherboard. The input sensitivity can be decreased, continuously, up to 20 dB nominally (in the range of 50 to 500 MHz) and 10 dB nominally (in the range of 500 to 1000 MHz).

3-6. MODES OF OPERATION

3-7. The 5316A provides 10 modes of operation and two CHECK functions. The resolution and accuracy for each mode except A Armed by B is provided in *Table 1-1*. The modes of operation are described in the following paragraphs:

FREQ A	A BY B (Gated Totalize)
PER A	FREQ A ARMED BY B
T.I. A→B	FREQ C (Option 003)
T.I. AVG. A→B	TOT (Manual Totalize START/STOP)
T.I. DELAY (Holdoff)	CHECK
RATIO A/B	Display Check

3-8. FREQ A

3-9. Frequency measurements are made by connecting a signal (up to 100 MHz) to INPUT A, and pressing the FREQ A function (with the Blue Shift key OUT). Select the appropriate input signal conditioning and adjust the LEVEL/SENS control (with TRIGGER LEVEL/SENSITIVITY key to TRIGGER LEVEL) to the optimum trigger point. The optimum trigger point may be determined by centering the LEVEL/SENS control within the triggering range, and triggering is indicated by the flashing TRIGGER light. The actual trigger voltage may be determined by monitoring the TRIGGER LEVEL OUT on the front panel. The voltage at these points will be within $\pm 5\% \pm 15$ mV of the actual trigger voltage over a ± 2.0 volt range. The GATE TIME control determines the resolution of the measurement, and may be

displayed by pressing the GATE TIME function key and Blue Shift key. The gate time range when FREQ A is pressed is 60 ms to 10 s, typical. However a gate time range of 500 μ s to 30 ms is available by pressing T.I. DELAY and TOT STOP/START simultaneously. When the Blue Shift key is OUT, the 5316A will be in FREQ A. When the Blue Shift key is IN, the 5316A will be in PER A. PER A is discussed in the following paragraph.

3-10. PER A

3-11. The Period A mode allows signal period measurements to be made over a range of 10^5 s to 10 ns into INPUT A. Select the appropriate input signal conditioning, and Trigger Level/Sensitivity. The gate time range is 60 ms to 10 s, typical, when PER A is pressed. However, a shorter gate time is also available for PER A (500 μ s to 30 ms) as described in FREQ A, paragraph 3-9.

3-12. T.I. A \rightarrow B

3-13. T.I. A \rightarrow B measures the time interval between a START signal at INPUT A and a STOP signal at INPUT B. If both the START and STOP signals are derived from the same signal, connect the signal to INPUT A and set the SEP/COM A key to the COM A position (IN). Separate Slope and Level/Sensitivity controls for each channel allow variable triggering on either positive or negative going slope. A single-shot time interval measurement may be made over a range of 100 ns to 10^5 s.

3-14. T.I. AVG A \rightarrow B

3-15. The T.I. Average mode provides greater resolution of time interval measurements than single-shot T.I. mode provides. In the T.I. AVG mode, the gate time control varies the number of events of time intervals averaged (approximately GATE TIME \times REP RATE). The resolution of the measurement is improved by the \sqrt{N} , where N is the number of time intervals averaged. A limited range of negative T.I. measurements (i.e., B triggers before A) are possible in T.I. AVG mode.

3-16. In the T.I. AVG mode, there must be at least 200 ns dead time. Dead time is the time between the preceding time interval stop event and the current time interval start event, as shown in Figure 3-1. This means that in T.I. AVG mode, the repetition rate must be less than 5 MHz. Also time interval averaging of high stability (synthesized) sources is not recommended because the displayed result may not be accurate. Proper averaging requires that there be no coherence between the source and the counter time base oscillator.

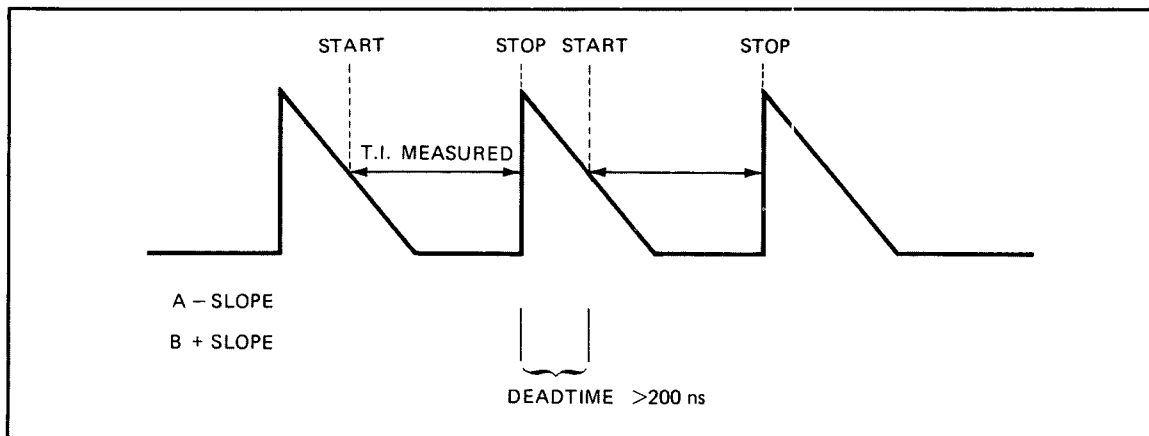

Figure 3-1. T.I. Average Dead Time

3-17. T.I. DELAY (HOLD OFF)

3-18. The T.I. DELAY mode of operation is similar to T.I. A→B, but with the following additional control: The front panel GATE TIME control inserts a variable delay (from 500 μ s to 30 ms nominal) between the START (INPUT A) event and the enabling of the STOP (INPUT B) event. Potential STOP events are ignored during the specified delay or holdoff. The amount of delay time may be continuously measured and displayed by simultaneously pressing the T.I. A→B, T.I. DELAY, and Blue Shift keys. *Figure 3-2* illustrates the T.I. DELAY function. It should be noted that both START and STOP Slopes are positive in this illustration.

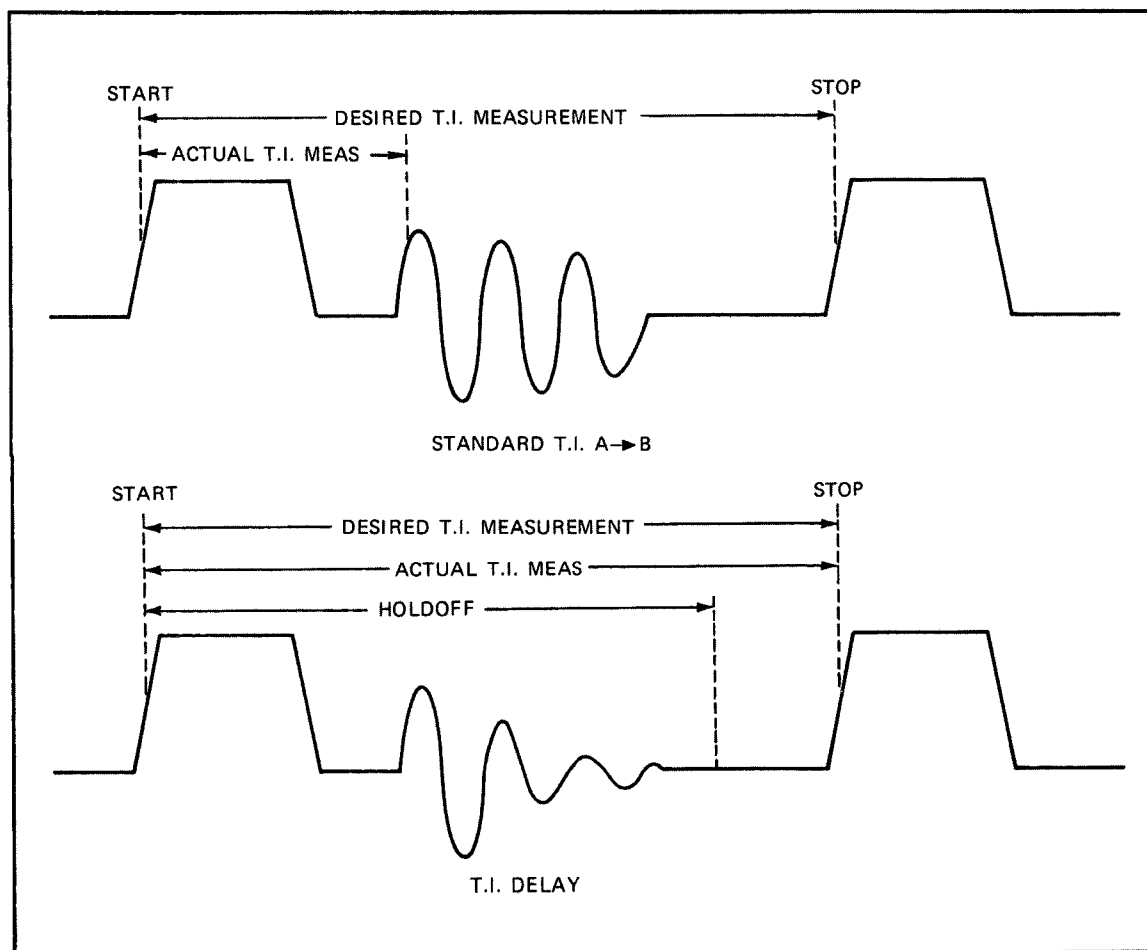

Figure 3-2. T.I. DELAY

3-19. RATIO A/B

3-20. The RATIO A/B mode of operation measures and displays the frequency ratio of signals on INPUT A to signals on INPUT B. The GATE TIME control determines the resolution by selecting the number of cycles of the INPUT B signal over which the ratio A/B is measured. Increasing the gate time (towards MAX) or increasing the frequency of INPUT A results in an increased resolution of the measurement. Frequencies up to 100 MHz are allowed on both channels.

3-21. A BY B

3-22. A BY B (A gated by B) is a totalize mode of operation (see *Figure 3-3*) in which events on INPUT A (up to 100 MHz) are counted for a duration determined by INPUT B. The gate is "OPENED" on the slope of Input B selected by the Channel A Slope switch, and "CLOSED" on

the slope of Input B selected by the Channel B Slope switch. This allows any one of four discrete gate durations from a given signal on Input B. The Channel A Slope switch also determines which slope of the events signal (on INPUT A) is counted. A BY B is a single-shot mode of operation. The RESET button must be pressed to clear the display and allow the initiation of a new measurement.

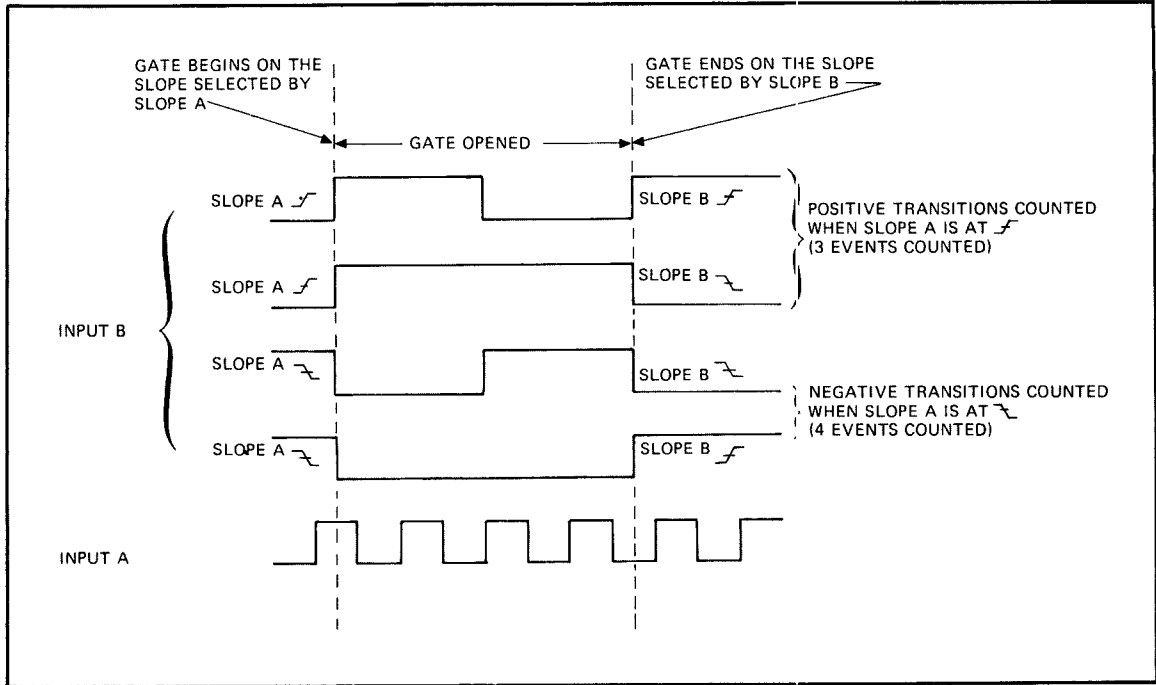

Figure 3-3. Totalize A BY B

3-23. A ARMED BY B

3-24. The 5316A has a measurement function, Frequency A, Averaged, Armed By B, for frequency averaging. Called "A ARMED BY B", this function allows the 5316A to average together multiple frequency measurements. To do this a sampling signal synchronized with and of pulse width less than the frequency bursts must be applied to the Channel B input. This signal performs two functions: one, it tells the the 5316A when to count the incoming bursts and when to ignore the dead time between bursts; and two, it opens the 5316A gate. The measurement interval is set from the front panel and its length determines the number of bursts to be averaged. Figure 3-4 shows an example of function A Armed By B. In this example, 1MHz bursts, 10 μ s wide, at a 10 kHz repetition rate are applied to Channel A input. A sampling signal of equal repetition rate and shorter pulse width is applied to Channel B. This sampling signal must be synchronized with the Channel A frequency burst signal. When the first burst occurs, the sampling signal at Channel B opens the gate, and tells the 5316A to begin counting the events at Channel A. When the sampling signal disappears, the 5316A stops counting the events at Channel A. If the gate is still open and another burst occurs, the 5316A will add these "new" events to the previous events counted. This will continue until the measurement interval runs out. On the next sampling pulse, after the gate closes, the 5316A will compute the average frequency of the signal during the burst (in this example 1 MHz). A final sampling pulse **must** occur after the measurement interval ends to terminate the measurement. The events that occurred during this final pulse are not averaged in.

3-25. The length of the measurement interval and signal repetition rate determine how many bursts will be averaged. Faster burst repetition rates allow shorter measurement intervals for a given number of averages. The main limit is that no more than 100 million "events" can be counted (either input frequency cycles or time base counts). In the case of Figure 3-4, each burst contains 10 "events", with 10

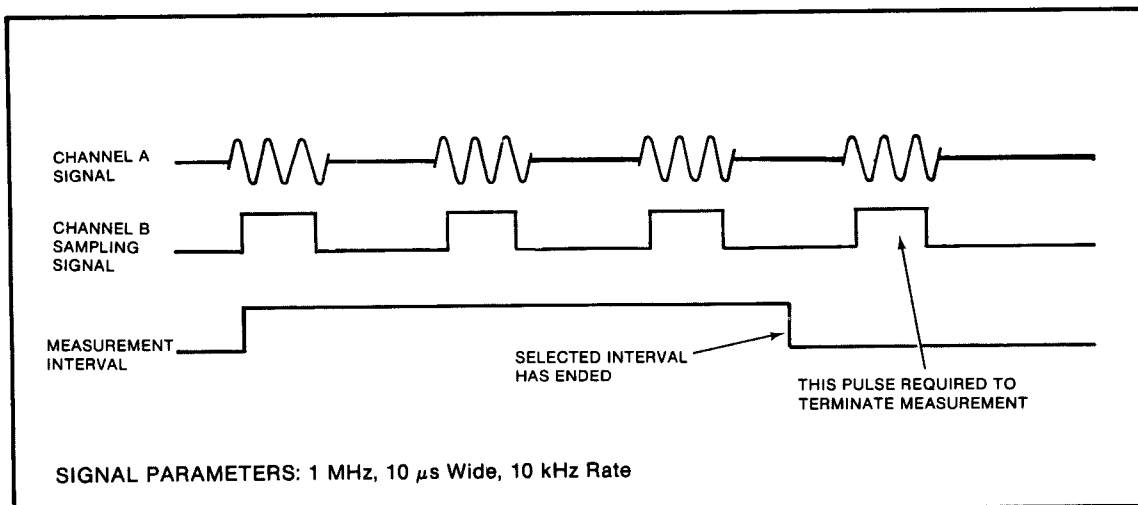

Figure 3-4. A ARMED BY B

thousand occurring in 1 second for 100 thousand "events" per second. Since 100 million events is the limit, the 5316A could average for 1000 seconds before the events counter would overflow. And, since the measurement interval determines the number of averages, a 1000-second measurement interval would be necessary before the events count or time base count would overflow. This, of course, is longer than that obtainable from the 5316A (maximum measurement interval of ~ 10 seconds). A specific case where the 5316A would overflow would be a 50 MHz signal pulsed for 200 ns at a 2 MHz rate. In this case 10 "events" occur during each burst, with 2 million bursts per second, or 20 million "events" in 1-second. So, the 5316A would overflow in 5 seconds, thus the gate time must be less than 5 seconds, and 10 million bursts would be averaged. If the 100 million events limit is exceeded the displayed answer will be inaccurate.

3-26. A ARMED BY B has two modes (two different measurement interval ranges) and is not labeled on the front panel. For a measurement interval range of 500 μ s-30 ms, press T.I. DELAY and RATIO A/B together. The measurement interval may be displayed by selecting the GATE TIME mode for the LONG interval or by pressing T.I. A \rightarrow B, T.I. DELAY, and Blue Shift key simultaneously for the SHORT interval. For a measurement interval range of 60 ms to 10 seconds, press FREQ A and TOT STOP together. The Channel A Trigger Slope is set by the front panel Channel A Slope switch. The sampling signal enable slope (begin counting) is determined by the Blue Shift key. In the OUT position the counting will be enabled on the sampling signal positive slope. In the IN position, the counting will be enabled on the sampling signal negative slope. The gate will also be opened on the same slope as determined by the Blue Shift key. The disable slope is determined by the Channel B front panel slope switch. The measurement interval is controlled, as normal, by the front panel GATE TIME control. The gate will close once the selected time has passed. There is no problem if the gate should close in the middle of counting a burst. The following limits do exist in this mode.

1. 200 ns minimum dead time between bursts.
2. 100 ns minimum burst width.
3. The enable slope can only be negative when using the short measurement interval (500 μ s-30 ms), but can be positive or negative when under remote control.

Resolution increases with the square root of the number of samples averaged, N.

$$\text{Resolution} \sim \frac{(10^{-7}) \times (\text{INPUT FREQ})}{(\text{Sampling Signal Width}) \times (\sqrt{N})} \quad \text{Hz}$$

$$N \sim \frac{\text{Measurement Interval}}{\text{Gate signal repetition rate}}$$

From Figure 3-4, the sampling signal is 10 μ s wide at a 10 kHz repetition rate with a measurement interval of 1-second. With a single-shot measurement:

$$\text{resolution} = \frac{100 \times 10^{-9}}{10 \times 10^{-6}} \times \frac{1 \times 10^6}{\sqrt{N}} = 10^4 \text{ or } 10 \text{ kHz resolution}$$

but with average N = 10000 (1 s measurement interval):

$$\text{resolution} = \frac{100 \times 10^{-9}}{10 \times 10^{-6}} \times \frac{10^6}{\sqrt{10000}} = 100 \text{ Hz (100 times better)}$$

Accuracy: The actual measurement interval is shorter than the correct value by about 1 ns. With short sample pulse widths and large N values the displayed answer will not be perfectly accurate:

$$\text{Ultimate accuracy} = \frac{10^{-9}}{\text{measurement interval}} \times (\text{Input FREQ})$$

With a 10 μ s sample pulse width, accuracy can be as good as 100 Hz if enough events are averaged.

3-27. FREQ C (Option 003)

3-28. To make a frequency measurement on a CW signal in the range of 50 MHz to 1 GHz, select FREQ C function and apply the signal to INPUT C.

CAUTION

Make sure that the amplitude of the signal does not exceed the 1V rms dynamic range.

Set the GATE TIME control to MIN (but not hold). Set the SENS C control to MIN. Slowly move the SENS C control in a clockwise direction (toward MAX) until the counter begins to gate. This represents the optimum trigger sensitivity. To increase the displayed resolution, move the GATE TIME control toward MAX.

NOTE

The Trigger Lights for INPUT A and INPUT B are inoperative and extinguished when functions FREQ C or GATE TIME are selected. This is normal. However pressing either Channel A or B Slope switches will reset the counter.

3-29. TOT STOP/START

3-30. Totalize STOP/START is a manually gated, Totalize mode of operation. Pressing the Blue Shift key (IN position) opens the main gate, allowing INPUT A events to be counted. Pressing the Blue Shift key again (OUT position) closes the gate, stopping the count. The count is continuously displayed, and cumulative from gate cycle to gate cycle. The RESET button clears the counter and resets the display to zero.

3-31. CHECK

3-32. The Check function applies 10 MHz from the internal (or external) reference oscillator to the Multiple Register Counter (MRC). It is used to verify the basic operation of the counter, GATE light and GATE TIME control.

3-33. Display Check

3-34. The Display Check is an unlabeled function, which cycles the display through a routine that exercises all digits and most annunciators. With the POWER switch to ON, and all function switches to the "OUT" position, a rolling display, corresponding to Table 3-1, will result.

Table 3-1. Display Check

Digit Displays (7-segment)	OVFL	ERROR	-	Hz	S	GATE	Decimal Point Position		
							1	2	3
0							*		
1	*		*					*	
2	*				*				*
3	*		*		*				
4	*			*					
5	*	*	*	*					
6	*			*	*				
7	*		*	*	*				
8	*					*			
9	*		*			*			
BLANK	*		*	*	*	*			

3-35. PANEL FEATURES AND CONTROLS

3-36. The following paragraphs describe the features and controls of function selection, signal conditioning, and display sections of the front panel. Front and rear panel controls are individually located and described in *Figures 3-10* and *3-11*.

3-37. FUNCTION SELECTION CONTROLS

3-38. The function selection controls section of the front panel contains the POWER (STBY/ ON), and RESET/LOCAL keys, the "Function" keys group (within the border outline) and Gate Time/Delay control.

3-39. The POWER key sets the 5316A either to ON or STBY (standby). In the ON position (IN) power is supplied to the entire instrument. In the STBY position (OUT) the unregulated voltages are disconnected from the power supply voltage regulators. The RESET/LOCAL key clears and updates the display for continuous measurement modes, and resets the counter in Totalize modes. Also see Remote Programming via the HP-IB paragraph 3-73.

3-40. Each of the keys within the outlined function group can select one of two functions, as follows: With the Blue Shift key in the "OUT" position, the keys select the function labeled above (e.g., FREQ A, T.I. A→B, etc.). With the Blue Shift key in the IN position, the keys select the function labeled in blue below (e.g., PER A, T.I. AVG A→B, etc.).

3-41. The GATE TIME/DELAY control determines the amount of gate time per measurement, continuously adjustable over a range of 60 ms to 10 s. The selected gate time may be displayed by pressing the GATE TIME function key, and the Blue Shift keys. In the T.I. DELAY mode of operation, the control determines the amount of time the start channel is held off or "delayed" (see paragraph 3-17). The amount of "delay" may be displayed by pressing the T.I. A→B, T.I. DELAY, and Blue Shift key simultaneously. In the T.I. A→B mode of operation, the GATE TIME/DELAY control determines the "sample rate".

3-42. SIGNAL CONDITIONING CONTROLS

3-43. A full complement of signal conditioning controls are provided for each channel (A and B) input (see *Figure 3-6*). These controls allow the selection of Attenuation (X1, X20), Slope (positive or negative) and input coupling (AC or DC). The SEP/COM A switch allows the selection of separate Channel A and B input in the SEP position. The COM A position disconnects the Channel B Input BNC, and connects both Channel A and Channel B input amplifiers to the Channel A input.

3-44. A low pass filter for Channel A input is provided. With the FILTER NORM key in the 100 kHz (IN) position, frequencies above 100 kHz are effectively attenuated. With the FILTER NORM key in the Normal (OUT) position there is no effect.

3-45. TRIGGER LEVEL/SENSITIVITY CONTROLS

3-46. The Trigger Level/Sensitivity controls provided for each channel operate as follows: With the TRIGGER LEVEL/SENSITIVITY key in the "OUT" position, the LEVEL/SENS control adjusts the trigger level, (over a range of ± 2.5 volts dc in ATTN X1, or ± 50 volts dc in ATTN X20). With the TRIGGER LEVEL/SENSITIVITY key in the "IN" position, the LEVEL/SENS control adjusts the input sensitivity from MAX (10 mV up to 10 MHz, 25 mV up to 100 MHz) with control fully clockwise to MIN (greater than 500 mV) with control fully counterclockwise (see *Figure 3-5*). The trigger levels may be monitored at the front panel TRIGGER LEVEL jacks. The voltage at this point is $\pm 5\% \pm 15$ mV of the actual voltage over the range of ± 2.0 V.

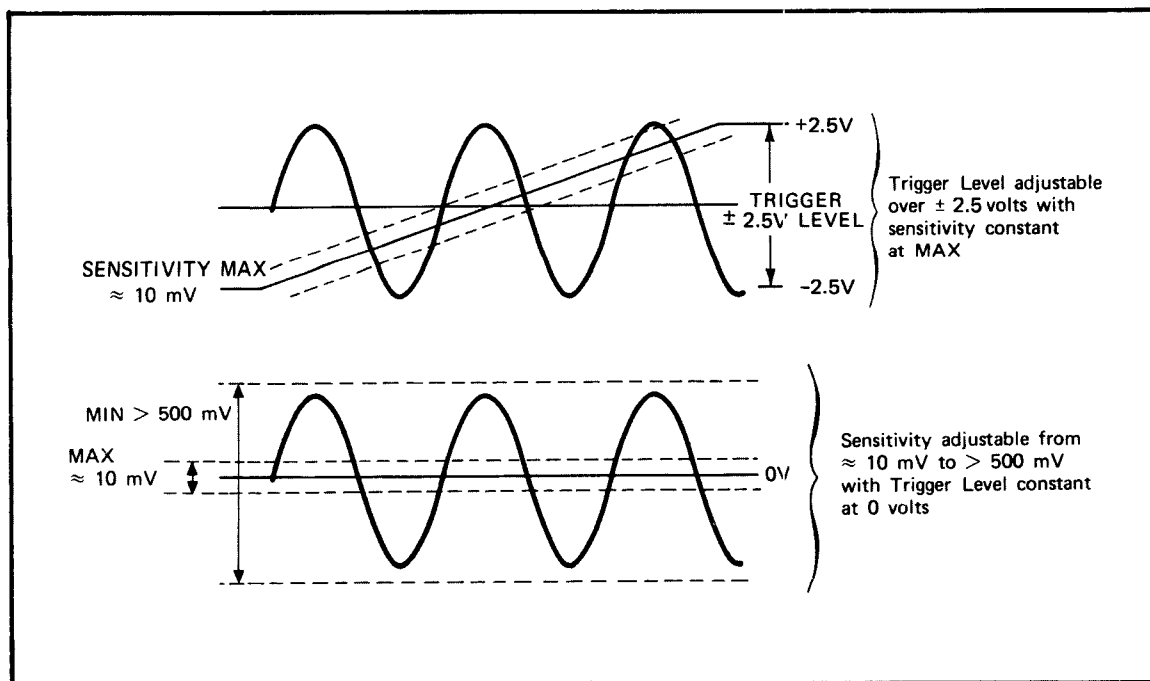

Figure 3-5. Trigger Level/Sensitivity Control

3-47. DISPLAY

3-48. The 5316A counter display consists of nine LEDs, providing eight digits of resolution and a one-digit exponent. All measurements (except Totalize modes) are displayed in engineering notation [i.e., exponents of blank (none), ± 3 , ± 6 , or ± 9 (+ is not displayed)] with automatic decimal point location. Annunciators for indicating the measurement units Hz, for Hertz, and s, for seconds are provided. The OVFL annunciator indicates that the leftmost significant digits have overflowed

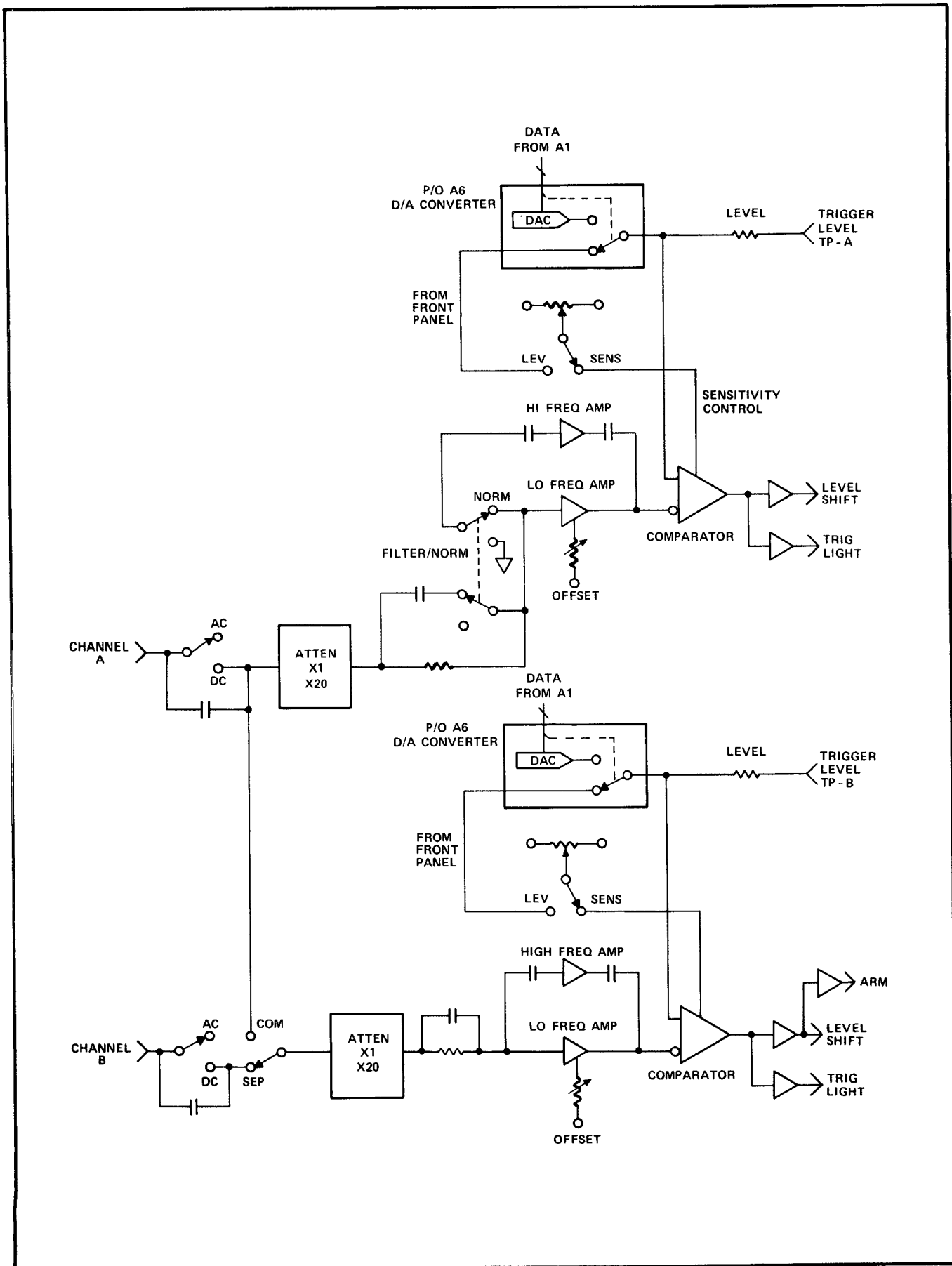

Figure 3-6. Input Amplifier Block Diagram

the display. The GATE annunciator indicates the counter has been triggered and a measurement is in progress. The ERROR annunciator indicates a failure during power-up self-check (see paragraph 3-59). The ADRSD and REMOTE lamps annunciators indicate the instrument's status during remote control (see Paragraph 3-86).

3-49. OPERATOR'S CHECKS

3-50. A procedure for verifying the basic operation of the 5316A is provided in *Figure 3-12*. This check utilizes the instrument's self-calibration cycle and visual verification of front panel controls by front panel indicators. No additional equipment is required.

NOTE

This check is not intended to verify the accuracy or performance specifications of the instrument.

3-51. OPERATING INSTRUCTIONS

WARNING

BEFORE THE INSTRUMENT IS SWITCHED ON, ALL PROTECTIVE EARTH TERMINALS, EXTENSION CORDS, AUTOTRANSFORMERS, AND DEVICES CONNECTED TO IT SHOULD BE CONNECTED TO A PROTECTIVE EARTH GROUNDED SOCKET. ANY INTERRUPTION OF THE PROTECTIVE EARTH GROUNDING WILL CAUSE A POTENTIAL SHOCK HAZARD THAT COULD RESULT IN PERSONAL INJURY.

WARNING

ONLY FUSES WITH THE REQUIRED RATED CURRENT AND SPECIFIED TYPE SHOULD BE USED. DO NOT USE REPAIRED FUSES OR SHORT CIRCUITED FUSE-HOLDERS. TO DO SO COULD CAUSE A SHOCK OR FIRE HAZARD.

CAUTION

Before the instrument is turned on, it must be set to the voltage of the power source, or damage to the instrument could result.

3-52. POWER-UP SELF-CHECK

3-53. When the 5316A is turned on, a power-up reset and self-check cycle is automatically initiated. This is approximately a 2-second cycle, indicated by the following display:

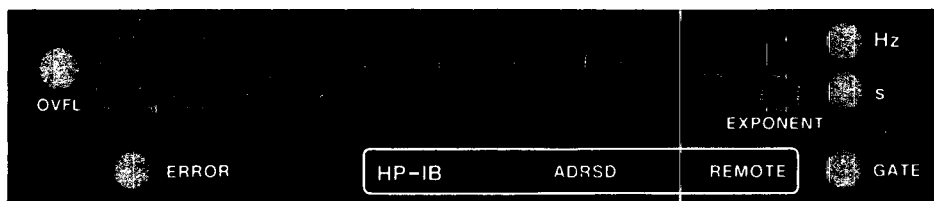

NOTE: Error LED may or may not light during Power-Up Self-Check

3-54. During this cycle, the microcomputer performs a check sum of the internal program in ROM and a bit pattern is written into RAM. Then it performs a partial check of the MRC and I/O ports, and performs a U1-U10 (3870-6801) link test between the microcomputers. Any failure during the cycle will produce a numbered error (for a U1 microcomputer, MRC or I/O failure), or a flashing of the HP-IB status LEDs (for a U1-U10 microcomputer link test failure). If a numbered error occurs, the ERROR LED will remain lit. Refer to Error Messages, paragraph 3-59. If the 5316A is placed into STANDBY and then immediately placed in ON again, the display will illuminate random segments during the power-up cycle. This is normal.

3-55. MEASUREMENT PROCEDURES

3-56. Figures 3-13 through 3-21 show general operating procedures with the HP Model 5316A Universal Counter in typical measurement setups. Description numbers match the locator illustrations. The following paragraphs provide recommended operating guidelines, to assist in making the most accurate measurement possible.

3-57. Frequency, Period, and Ratio Measurements

1. For cw sine wave or symmetrical waveforms (triangle, square, etc.) use ac coupling and the sensitivity mode.
2. For asymmetrical waveforms (pulse trains, TTL, ECL signals, ramps, etc.) use a combination of dc coupling, Trigger Level, and fixed attenuator. AC coupling these types of signals tends to distort them slightly, due to the charging of the capacitor. More important, the position of the signal on the zero preset trigger level is determined by the average dc level of the input. Depending on the pulse width and duty cycle, this dc average may be low enough to allow the base line noise to trigger the counter, producing false counts (see Figure 3-7). DC coupling fixes the dc level of the input signal, which allows the adjustable Trigger Level to be positioned at the optimum point. Set the Trigger Level control to the approximate center of the triggering range indicated by the trigger light (see Figure 3-8) The actual dc trigger level may be monitored at the front panel test point. When programming via the HP-IB, it may be set directly.

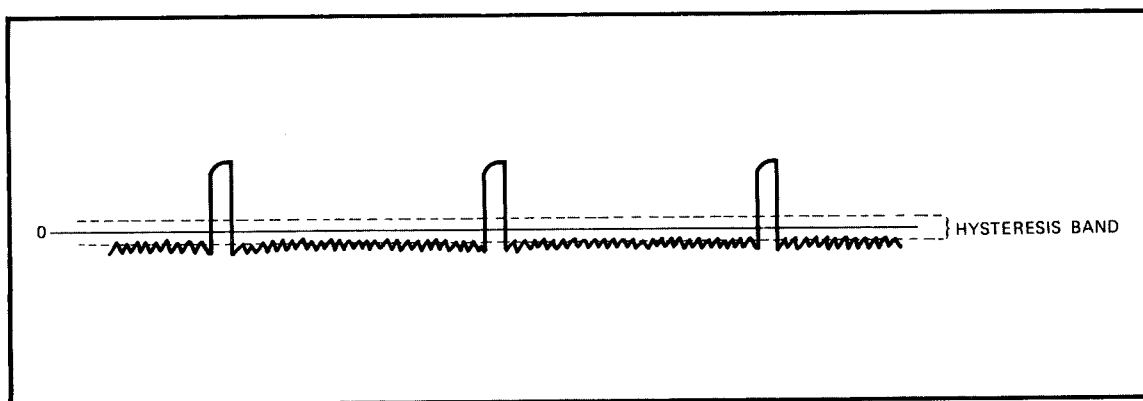

Figure 3-7. AC Coupled Measurements

3. When input loading is a problem (i.e., 1 M Ω load or cable capacitance) or when a more convenient method of probing is desirable, use a 10:1 scope probe. A probe is recommended for all logic applications.
4. For sine wave measurements <100 kHz, always use the low pass filter, selectable on the front panel. Normally the input signal is integrated over the entire 100 MHz bandwidth. Use of the Filter effectively removes noise and harmonics (above 100 kHz), that may affect the correct measurement.

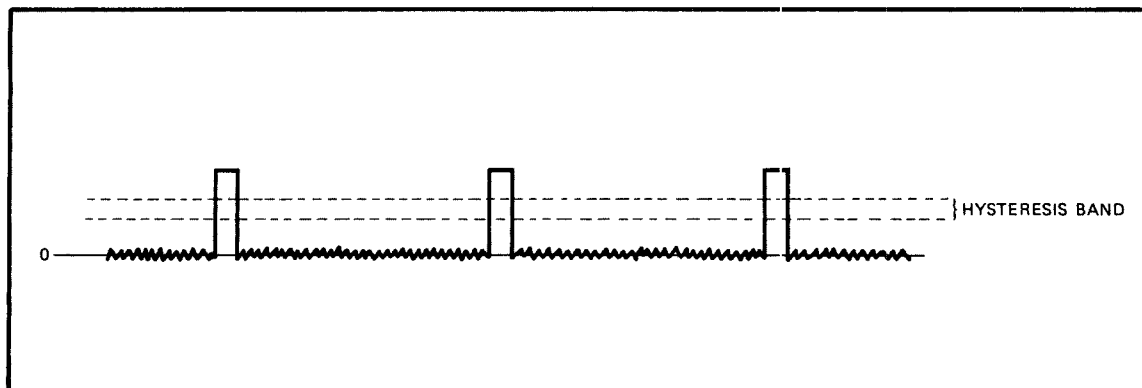

Figure 3-8. DC Coupled Measurements

5. Be very careful with input levels at higher frequencies (greater than 5 MHz). The counter front end is protected to 6 volts rms at these frequencies.

WARNING

WHEN MEASURING POWER LINE FREQUENCIES, BE EXTREMELY CAREFUL AND ALWAYS USE A STEP-DOWN ISOLATION TRANSFORMER (WITH $\approx 10V$ OUTPUT). THE COUNTER'S PANEL IS TYPICALLY AT SIGNAL GROUND, SO NEVER TRY TO MEASURE THE 50 OR 60 Hz LINE WITHOUT AN ISOLATION TRANSFORMER.

3-58. Time Interval Measurements

1. To insure waveform fidelity during T.I. measurements, always use dc coupling.
2. Measurements of pulse width, and time between pulses, are more conveniently made in the COM A (common) position.
3. T.I. Average measurements of high stability (synthesized) sources are not recommended. The displayed result may not be accurate. Proper averaging requires that there be no coherence between the source and the counter time base oscillator. (See Application Note 162-1, Time Interval Averaging.)
4. In general, use the GATE TIME control to vary the amount of resolution displayed. This control does not affect accuracy. It basically trades off longer measurement time for more resolution.

3-59. TROUBLESHOOTING/ERROR MESSAGES

3-60. Two different type error messages exist in the 5316A. First is the numbered errors. Failures in the power-up self-check will result in the momentary display of one of these messages. The ERROR LED will remain on until the error is cleared and the instrument reset. The three error messages are:

ERROR	MESSAGE
E1	Possible failure in microcomputer A1U1 (3870)
E2	Possible failure in I/O ports
E3	Possible failure in A1U2 (MRC); rear panel oscillator switch in the EXT position with no external signal; or a failure in the A7 oscillator assembly.

If the ERROR annunciator is lit, verify the error number (1, 2, or 3) by repeating the power-up self-check, and refer to Section VIII, Troubleshooting, paragraph 8-45, step h. Power-up self-check is initiated when the POWER switch is placed from STBY to ON.

3-61. The two HP-IB status annunciators indicate a failure in the following ways:

- Flashing in-phase Possible failure in the HP-IB microcomputer A1U10 (6801).
- Flashing out-of-phase Possible A1U1-U10 (3870-6801) link failure or defective HP-IB microcomputer A1U10 (6801).

If one of these failures occur when the POWER switch is placed in ON from STBY, refer to Section VIII, Troubleshooting, paragraph 8-45, step m.

3-62. OPTIONS

3-63. The operating characteristics of the 5316A are affected by the addition of any of the options described in the following paragraphs.

3-64. Time Base Options

3-65. Option 001 provides a Temperature Compensated Crystal Oscillator (TCXO) which results in higher accuracy. The TCXO is a 10 MHz oscillator, capable of making minor frequency corrections to compensate for offsets due to temperature variations. Option 004 Oven Oscillator provides increased temperature stability and accuracy over Option 001. See *Table 1-1* for complete specifications of Options 001 and 004.

3-66. Channel C Option 003

3-67. Option 003 extends the frequency counting range of the 5316A from 100 MHz (in Channel A) to 1 GHz (in Channel C). The input sensitivity and gate time are adjustable via front panel controls. See *Table 1-1* for complete specifications of Option 003.

3-68. OPERATOR'S MAINTENANCE

3-69. The only maintenance the operator should normally perform is the replacement of the primary power fuse. This fuse is located within the Line Module Assembly. For instructions on how to change the fuse, refer to paragraph 2-8, Line Voltage Selection.

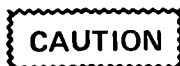

Make sure that only fuses with the required rated current and of the slow-blow type are used for replacement. The use of repaired fuses and the short-circuiting of fuse-holders must be avoided.

3-70. When Option 003 Channel C is installed, the operator may be required to replace the input BNC fuse. This is a 1/8A fuse (HP Part No. 2110-0301) which is located within the INPUT C BNC connector (see *Figure 3-9* for details). To replace the fuse, disconnect the power cord, unscrew the special BNC barrel (P/N 05305-60205) and, with needle-nose pliers, remove and replace the fuse. Reinstall the BNC barrel, and tighten using a BNC cable connector. Be careful not to overtighten.

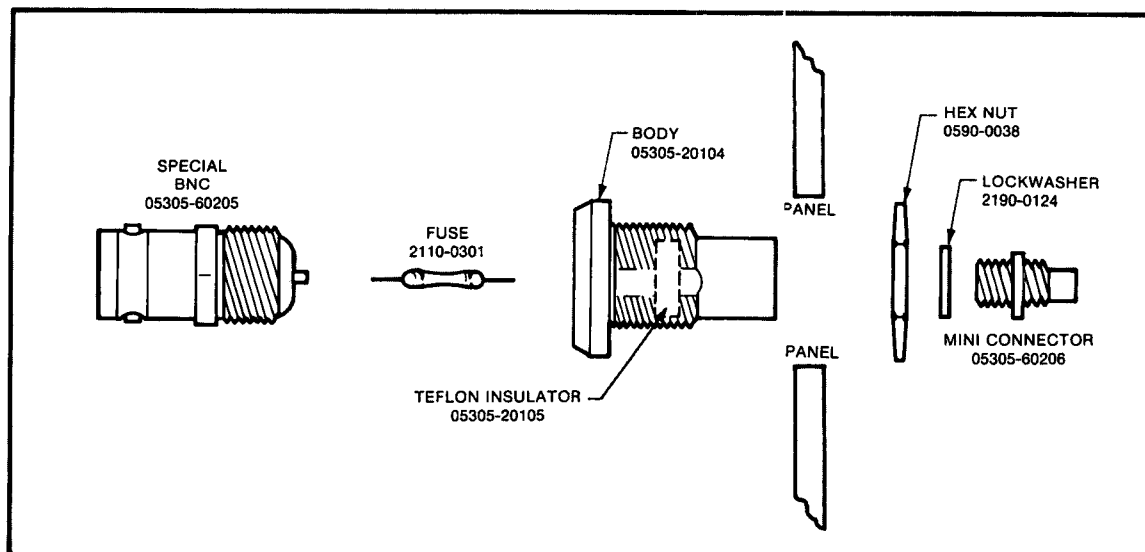

Figure 3-9. Details of Input Connector J1 and Fuse Mounting

3-71. POWER/WARM UP

3-72. The HP Model 5316A requires a power source of 100-, 120-, 220-, or 240-volt ac, +5%, -10%, 48 to 66 Hz single phase. The selection of line voltage and input power fuse is described in Section II, paragraph 2-8, Line Voltage Selection.

WARNING

POWER IS ALWAYS PRESENT AT THE LINE SWITCH AND TRANSFORMER, AND UNREGULATED DC IS PRESENT WHENEVER THE LINE CORD IS ATTACHED. UNPLUGGING THE POWER CORD IS NECESSARY TO REMOVE ALL POWER FROM THE INSTRUMENT.

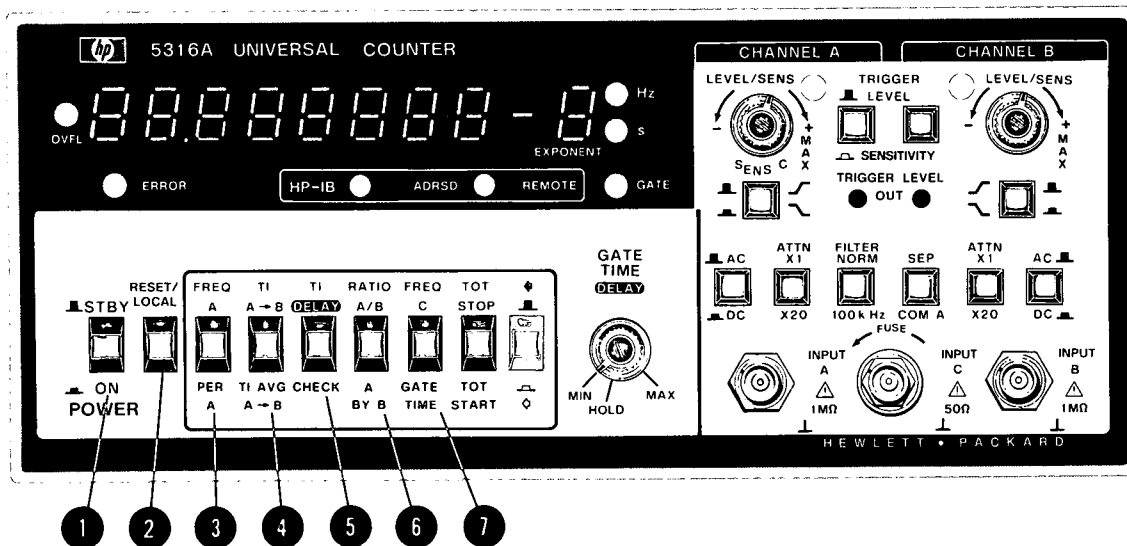

- 1 **STBY/ON.** Supplies power to entire machine in the ON position. Removes power from the voltage regulators when in the STBY (Standby) position.
- 2 **RESET.** Clears and updates display in continuous measurement modes, resets counter to zero in Totalize modes. Also returns operation to Local control.
- 3 **FREQ A.** Selects Frequency modes of operation (with Blue Shift key out), for signals on Input A.
PER A. Selects Period mode of operation (with Blue Shift key in), for signal on Input A.
- 4 **TI. A-B.** Selects Time Interval mode of operation (with Blue Shift key out) measuring time differences from Start signal on INPUT A to Stop signal on INPUT B (when in SEP).
TI. AVG A-B. Selects Time Interval Average mode of operation (with Blue Shift key in), measuring time difference from Start signal on INPUT A to Stop signal on INPUT B (when in SEP).
- 5 **TI. DELAY.** Selects Time Interval mode of operation (with Blue Shift key out), measuring time differences from Start signal on INPUT A to Stop signal on INPUT B (when in SEP) with the triggering of the Stop signal DELAYED (held off) for a period of time determined by GATE TIME DELAY control.
CHECK. Applies 10 MHz from reference oscillator to MRC (with Blue Shift key in), to verify operation of MRC, display and GATE TIME control, microcomputer, etc.
- 6 **RATIO A/B.** Selects Ratio mode of operation (with Blue Shift key out), measuring the ratio of the signal frequency at INPUT A to the signal frequency at INPUT B.
A BY B. Selects a "gated" Totalize mode of operation (with Blue Shift key in), in which the signal frequency of INPUT A is totalized for a gate duration determined by the signal on INPUT B.
- 7 **FREQ C.** Enables the Frequency C INPUT (Option 003) module (with the Blue Shift key out).
GATE TIME. Continuously measures and displays the gate time determined by the GATE TIME control (with Blue Shift key in).

NOTE

The trigger lights are disabled and extinguished when either FREQ C or GATE TIME is selected.

Figure 3-10. Front Panel Features

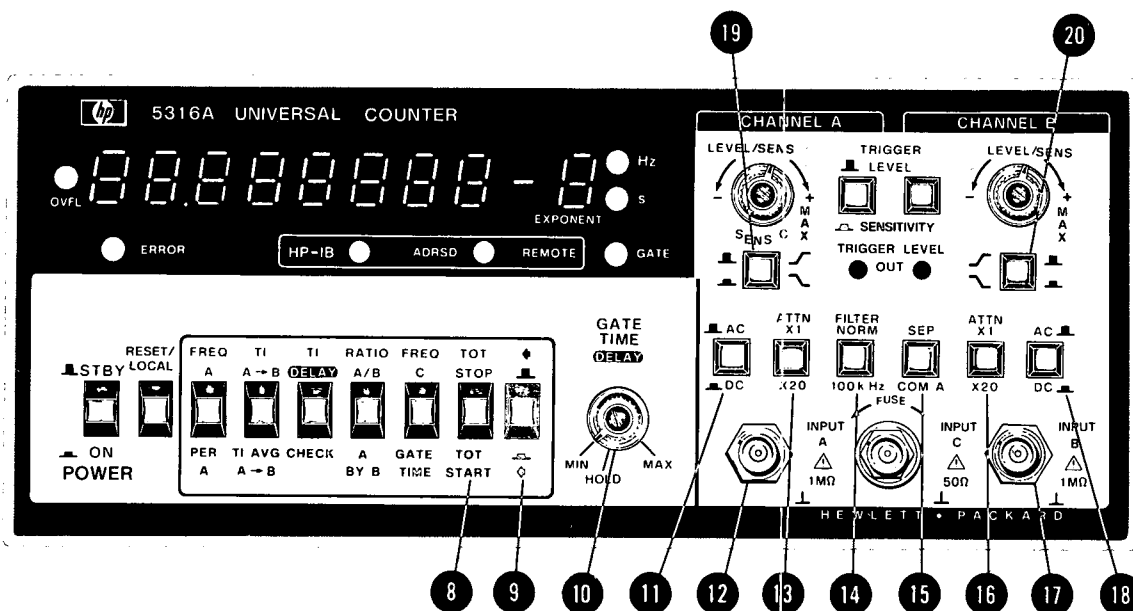

- 8 **TOT, STOP/START.** Selects Totalize mode of operation, manually controlled by the Blue Shift key. With the Blue Shift key in, totalizing of signal frequency on INPUT A starts. With the Blue Shift key out, Totalize accumulation stops and holds. RESET must be pressed to zero the display.
- 9 **Blue Shift.** Used in conjunction with six dual purpose function keys (3, 4, 5, 6, 7, 8) to select the function labeled above or below the key. With the Blue Shift key out, functions labeled above the keys are enabled, with the Blue Shift key in, functions labeled below the keys are enabled.
- 10 **GATE TIME/DELAY.** For FREQUENCY, PERIOD, RATIO AND T.I. AVERAGE modes, provides continuously variable measurement time from, nominally, 60 ms to 10 s (minimum = 1 period of the input signal). For T.I. mode, varies the time between measurements. For T.I. DELAY mode, provides continuously variable delay time between START and STOP enable.
HOLD. Single measurement with minimum gate time. Requires pushing RESET key to initiate new measurement.
- 11, 18 **AC/DC.** Selects ac or dc coupling for corresponding input signal. When in COM A, only Channel A determines coupling.
- 12, 17 **INPUT A, B.** Input BNC's for channels A and B.
- 13, 16 **ATTN, X1/X20.** Selects attenuation of signal on corresponding input channels. X1 position connects input signal directly to input amplifiers; X20 position attenuates input signal by a factor of 20 (nominal).
- 14 **FILTER, NORM/100 kHz.** Inserts a low pass filter configuration into the INPUT A channel, attenuating frequencies above 100 kHz.
- 15 **SEP/COM A.** Input amplifier control, selects independent operation of inputs A and B in SEP (separate) position. In COM A (Common A) position, the signal at Input A is also applied to Input B, with the B input BNC disconnected from input circuitry. Input B coupling is the same as Input A.
- 19, 20 **SLOPE.** Selects triggering on either positive \nearrow or negative \searrow slope of the corresponding input channel.

Figure 3-10. Front Panel Features (Continued)

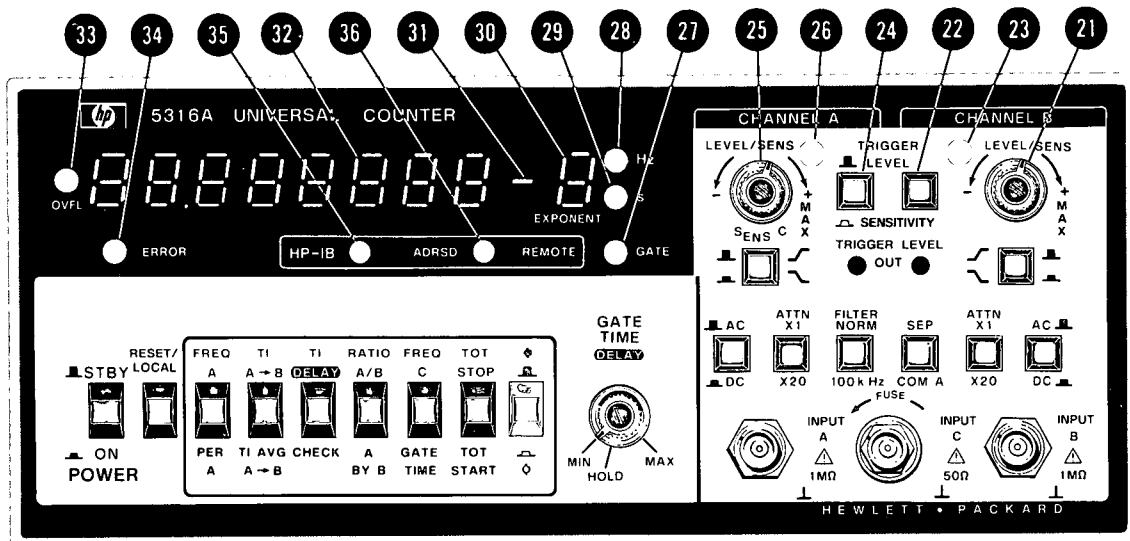

- 25 **LEVEL/SENS.** When in TRIGGER LEVEL, controls the voltage at which CHANNEL A input will trigger, variable over ± 2.5 volts X ATTN setting. When in SENSITIVITY, varies the sensitivity from MAX (≈ 10 mV) up to 500 mV. In FREQ C, controls the input sensitivity for INPUT C from MAX (≈ 15 mV up to 650 MHz, 75 mV up to 1 GHz) up to MIN (20 dB NOMINAL).
- 21 **LEVEL/SENS.** When in TRIGGER LEVEL, controls the voltage at which corresponding CHANNEL B input will trigger, variable over ± 2.5 volt X ATTN setting. When in SENSITIVITY, varies the sensitivity from MAX (≈ 10 mV) up to 500 mV.
- 22, 24 **TRIGGER LEVEL/SENSITIVITY.** Sets the function of corresponding LEVEL/SENS control to either Trigger Level or Sensitivity mode. In TRIGGER LEVEL mode, sensitivity is preset to maximum. In SENSITIVITY mode, trigger level is preset to 0 volts.
- 23, 26 **TRIGGER LIGHT.** 3-state trigger lights; blinks when channel is triggering; OFF when input signal is below trigger level setting; ON when input signal is above trigger level setting.
- 27 **GATE.** Gate light (when ON), indicates the counter's main gate is open and a measurement is in progress.
- 28 **Hz.** Hz (Hertz) annunciator, indicates displayed data is in frequency domain, in units of Hertz.
- 29 **S.** (seconds) annunciator, indicates displayed data is in time domain, in units of seconds.
- 30 **EXPONENT.** Displays the value of the exponent of the measurement. Measurements are displayed in engineering notation, with exponents of blank (\emptyset), ± 3 , ± 6 , ± 9 .
- 31 **EXPONENT SIGN.** Indicates the polarity of the displayed exponent; ON (-) if negative, OFF if positive.
- 32 **DISPLAY.** Eight-digit red LED display.
- 33 **OVFL.** OVFL (Overflow) annunciator indicates that one or more of the most significant digits are not displayed.
- 34 **ERROR.** Lights and remains lit when an error is detected during power-up.
- 35 **ADRSD.** Lights when the 5316A is addressed to Talk or Listen. See Paragraph 3-87.
- 36 **REMOTE.** Lights when the 5316A is under remote control. See Paragraph 3-87.
- 37 **TRIGGER LEVEL OUT CHANNEL A.** This allows the monitoring of the Channel A trigger level. The dc voltage is equal to the Channel A trigger level.
- 38 **TRIGGER LEVEL OUT CHANNEL B.** This allows the monitoring of the Channel B trigger level. The dc voltage is equal to the Channel B trigger level.

Figure 3-10. Front Panel Features (Continued)

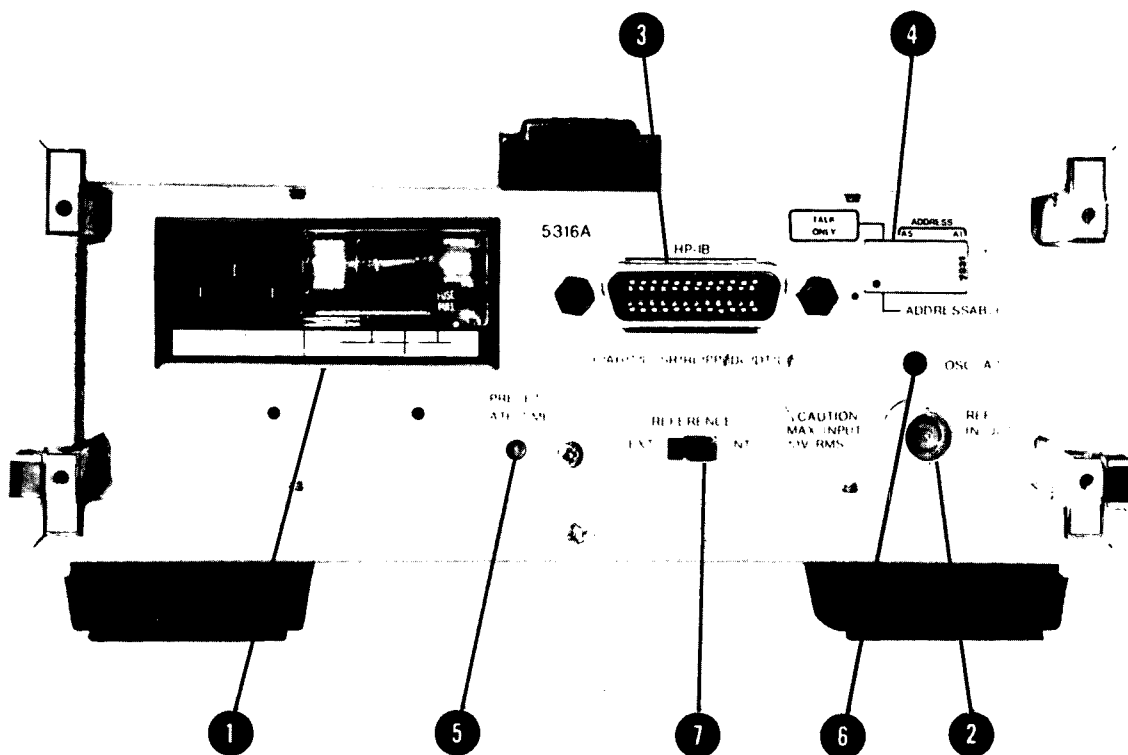

- 1 AC power input module permits operation from 100, 120, 220, or 240 volts ac. The number visible in the window indicates nominal line voltage to which instrument must be connected (see Figure 2-1). Protective grounding conductor connects to the instrument through this module.

WARNING

ANY INTERRUPTION OF THE PROTECTIVE (GROUNDING) CONDUCTOR INSIDE OR OUTSIDE THE INSTRUMENT OR DISCONNECTING OF THE PROTECTIVE EARTH TERMINAL IS LIKELY TO MAKE THE INSTRUMENT DANGEROUS. (See Section II.)

- 2 **REFERENCE INPUT/OUTPUT JACK (J8).** When 7, in the EXT position this allows the 5316A to be operated with an external frequency reference. The 5316A does not actually use the external input signal for a time base but locks-on to the signal with an injection-lock-multiplier. The external signal must be 1, 5, or 10 MHz at 500 mV rms across 500 ohms. When 7 in the INT position, the internal 10 MHz standard operates the counter, and the jack is the internal 10 MHz standard output signal at 50 mV p-p.
- 3 **HP-IB INTERFACE CONNECTOR (24 pin).** Used to convey data and programming information. IEEE-1978 compatible. See paragraph 3-73.
- 4 **HP-IB ADDRESS SWITCHES.** Selects the LISTEN/TALK address and ADDRESSABLE/TALK ONLY mode for remote control. See paragraph 3-83.
- 5 **PRESET GATE TIME.** Essentially the same as the front panel GATE TIME control without the HOLD position. Selectable only during remote programming. See paragraph 3-92c.
- 6 **OSCILLATOR ADJ.** This allows the adjustment of the internal reference oscillator.

Figure 3-11. 5316A Rear Panel Features

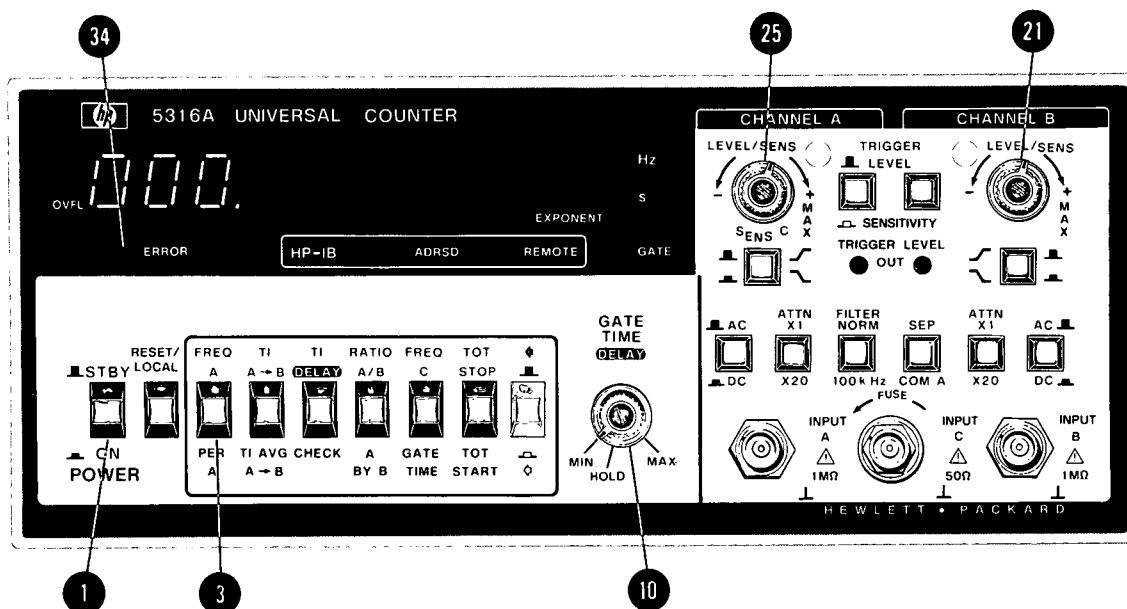

1. Before switching on the instrument, ensure that the power transformer primary is matched to the available line voltage, the correct fuse is installed and the safety precautions are taken. Refer to Power Requirements, Line Voltage Selection, Power Cables, and associated warnings and cautions in Section II of this manual.
2. Press FREQ A/PER A switch **3**, and adjust LEVEL/SENS controls **21** **25** fully ccw. Set All other switches to the OUT position.
3. Adjust GATE TIME control **10** to minimum.
4. Set POWER switch **1** to the ON position and observe the power-up self-check. Verify all segments of the display; decimal point after MSD; and the OVFL, Hz, S, and GATE annunciators light momentarily, followed by a display of 000. Verify both trigger lights are lit.

NOTE

When the instrument is first turned on, the microcomputer performs a self-check. If, during the self-check, an error is detected, a numbered error message will be displayed and will light the ERROR LED, or the HP-IB status LEDs will flash. Verify the error, by repeating the power-up self-check and referring to paragraph 3-59, Error Messages.

5. Verify the Display Check routine by placing all function select switches in the OUT position. This may be accomplished by pressing any gray colored function switch partially in, thus releasing a function switch that is locked in. Observe the cycling of the display from all zero's to all one's, two's, three's. . . etc., to all blank. Refer to paragraph 3-33.

NOTE

The Display Check routine is an unlabeled function, used to verify the operation, digits and most annunciators in the Display assembly.

Figure 3-12. Operator's Check

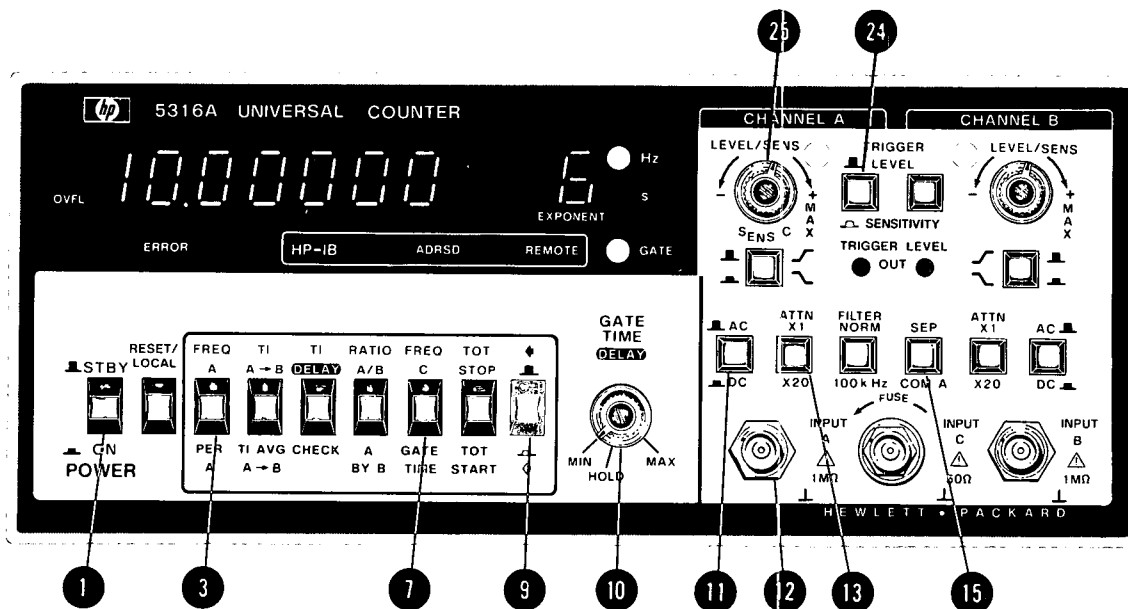

NOTE

For specifications concerning bandwidth, accuracy, and amplitude on input signals, refer to *Table 1-1*.

1. Set POWER switch **1** to the ON position.
2. Set SEP/COM A switch **15** to SEP position.
3. Connect the input signal to INPUT A jack **12**.
4. Press FREQ A/PER A switch **3**, and set the Blue Shift key **9** in the out position for FREQ A, or the in position for Period A.
5. Set AC/DC **11**, ATTN **13** and Slope **19** switches to appropriate positions.
6. Set GATE TIME control **10** to MIN.
7. Set TRIGGER LEVEL/SENSITIVITY switch **24** to SENSITIVITY position, and LEVEL/SENS control **25** fully ccw. This sets the trigger level at 0 volts (nominally) and sensitivity to minimum.
8. Adjust the LEVEL/SENS control **25** in a clockwise direction until a stable reading is obtained.
9. Adjust the GATE TIME control **10** for desired resolution. The gate time may be displayed by pressing the GATE TIME switch **7** and the Blue Shift key **9**.

Figure 3-13. Frequency A/Period A Measurements

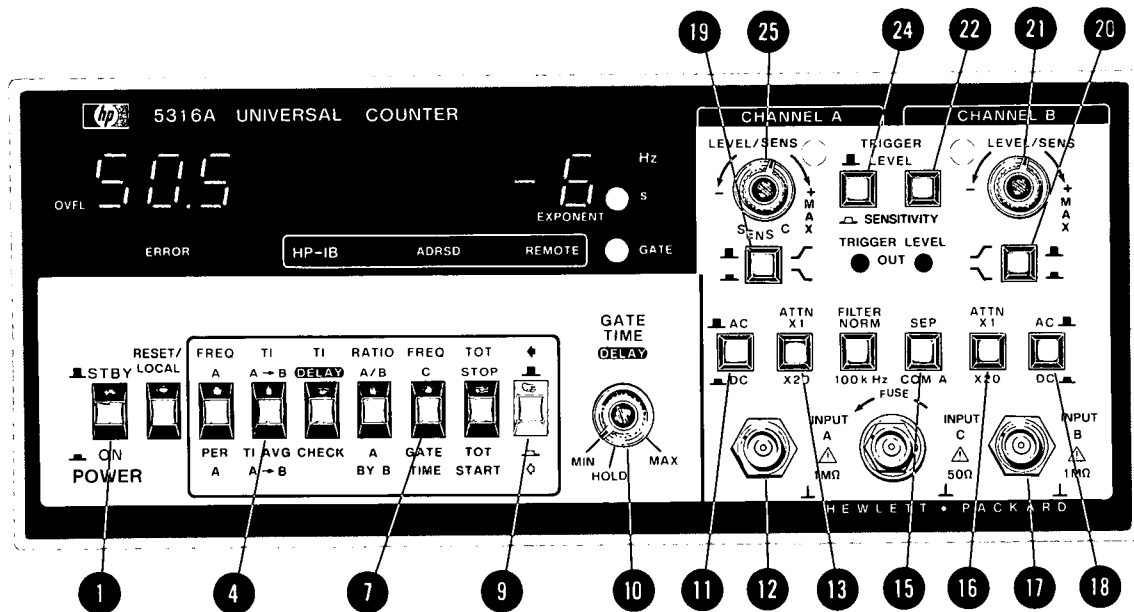

NOTE

For specifications concerning bandwidth, accuracy, and amplitude on input signals, refer to *Table 1-1*.

1. Set POWER switch **1** to the ON position.
2. Set GATE TIME control **10** to min.
3. If the Start and Stop signals are from separate sources, connect the Start signal to INPUT A jack **12**, the Stop signal to INPUT B jack **17**, and set the SEP/COM A switch **15** to SEP position. If the Start and Stop signals are from a common source, connect to INPUT A jack **12** and set the SEP/COM A switch **15** to COM A position.
4. Press T.I. A-B switch **4**, and insure the Blue Shift key **9** is in the out position, to select Time Interval function.
5. Set AC/DC **11** **18**, ATTN **13** **16**, and Slope **19** **20** switches to desired positions.

NOTE

When the SEP/COM A switch is set to COM A, only the CHANNEL A AC/DC switch **11** is effective. However, all Attenuator, Slope, and LEVEL/SENS controls are effective.

6. Set TRIGGER LEVEL/SENSITIVITY switches **22** **24** to TRIGGER LEVEL position. This sets the sensitivity to maximum (≤ 10 mV for frequencies ≤ 10 MHz) and allows variable selection of trigger levels.
7. Adjust the LEVEL/SENS controls **21** **25** for optimum triggering, usually the middle of the range over which the trigger light flashes.
8. Adjust the GATE TIME control **10** for the desired sample rate, variable nominally from 60 ms to 10 s. The selected gate time may be displayed by pressing the GATE TIME switch **7** and the Blue Shift key **9**.

NOTE

The first measurement is not displayed until the gate time delay is up. For slow sample rates, use HOLD and the RESET switch.

Figure 3-14. Time Interval Measurement

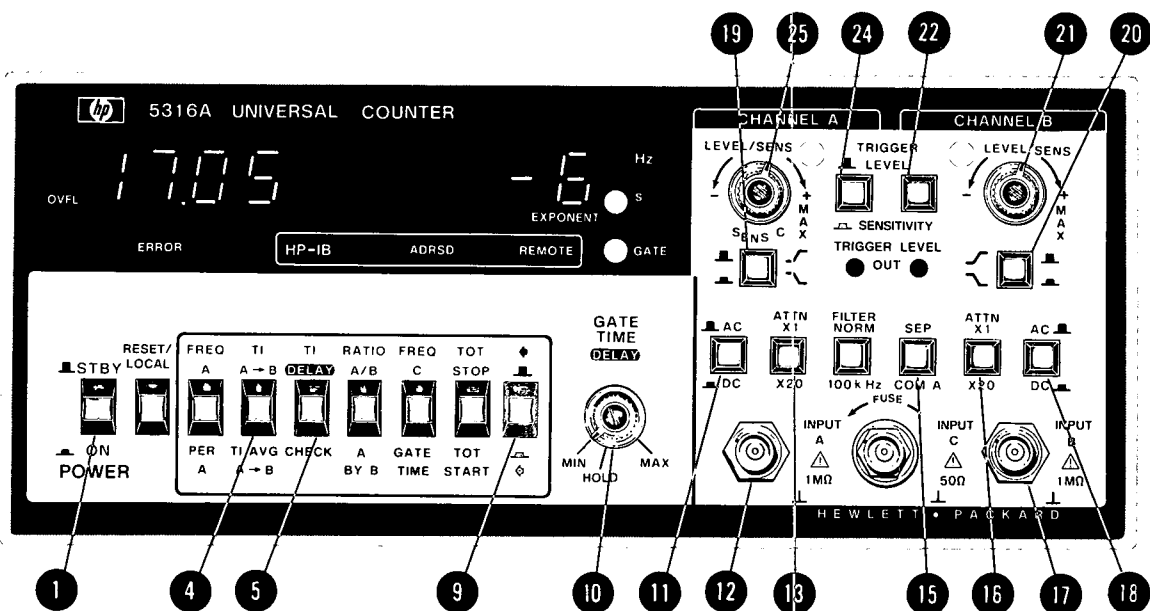

NOTE

For specifications concerning bandwidth, accuracy, and amplitude on input signals, refer to *Table 1-1*.

1. Set POWER switch **1** to the ON position.
2. If the Start and Stop signals are from separate sources, connect the Start signal to INPUT A jack **12**, the Stop signal to INPUT B jack **17**, and set the SEP/COM A switch **15** to SEP position. If the Start and Stop signals are from a common source, connect that source to INPUT A jack **12** and set the SEP/COM A switch **15** to COM A position.
3. Press T.I. DELAY switch **5**, and insure the Blue Shift key **9** is in the out position, to select Time Interval function.
4. Set AC/DC **11** **18**, ATTN **13** **16**, and Slope **19** **20** switches to desired positions.

NOTE

When the SEP/COM A switch is set to COM A, only Channel A AC/DC switch **11** is effective. However, all ATTENUATOR, SLOPE, and LEVEL/SENS controls are effective.

5. Set TRIGGER LEVEL/SENSITIVITY switches **22** **24** to TRIGGER LEVEL position. This sets the sensitivity to maximum (≤ 10 mV) and allows variable selection of trigger levels.
6. Adjust the LEVEL/SENS controls **21** **25** for optimum triggering (i.e., the middle of the range over which the trigger light flashes).
7. Adjust the GATE TIME/DELAY control **10**, for the desired holdoff, (variable nominally from $500 \mu\text{s}$ to 30 ms) between the Start on Channel A and the enabling of Stop on Channel B. Inputs during the delay time are ignored. The selected delay time may be displayed by pressing T.I. A-B **4**, T.I. DELAY **5** and Blue Shift key **9**.

Figure 3-15. Time Interval Delay Measurement

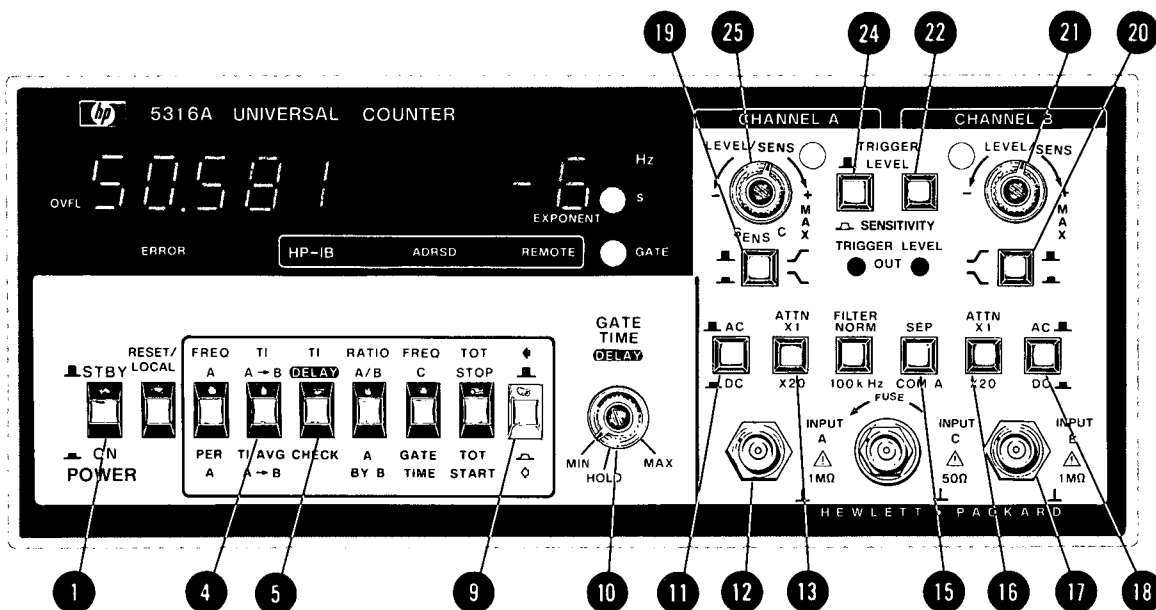

NOTE

For specifications concerning bandwidth, accuracy, and amplitude on input signals, refer to *Table 1-1*.

1. Set POWER switch **1** to the ON position.

NOTE

There must be at least 200 ns between the Stop pulse and the next Start pulse. When measuring the time interval between the same polarity slope of two pulses from a single source, the PER A mode should be used.

2. If the Start and Stop signals are from separate sources, connect the Start signal to INPUT A jack **12**, the Stop signal to INPUT B jack **17**, and set the SEP/COM A switch **15** to SEP position. If the Start and Stop signals are from a common source, connect to that source INPUT A jack **12** and set the SEP/COM A switch **15** to COM A position.
3. Press T.I. A-B switch **4**, and the Blue Shift key **9**, to select time interval average function.
4. Set AC/DC **11** **18**, ATTN **13** **16**, and Slope **19** **20** switches to desired positions.

NOTE

When the SEP/COM A switch is set to COM A, only the Channel A AC/DC switch **11** is effective. However, all ATTENUATOR, SLOPE, and LEVEL/SENS controls are effective.

5. Set TRIGGER LEVEL/SENSITIVITY switches **22** **24** to TRIGGER LEVEL position. This sets the sensitivity to maximum (≤ 10 mV) and allows variable selection of trigger levels.
6. Adjust the LEVEL/SENS controls **21** **25** for optimum triggering (i.e., the middle of the range over which the trigger light flashes).
7. Adjust the GATE TIME control **10** for the desired resolution. The selected gate time may be displayed by pressing the GATE TIME switch **7** and the Blue Shift key **9**.

NOTE

The T.I. Average A-B mode of operation will measure time intervals from 10^5 seconds to 0 ns, with up to 10 ps resolution. A display of up to “-” 1 or 2 ns, indicating a negative time interval (i.e., Channel B event occurred before Channel A event) is possible.

Figure 3-16. Time Interval Average A-B

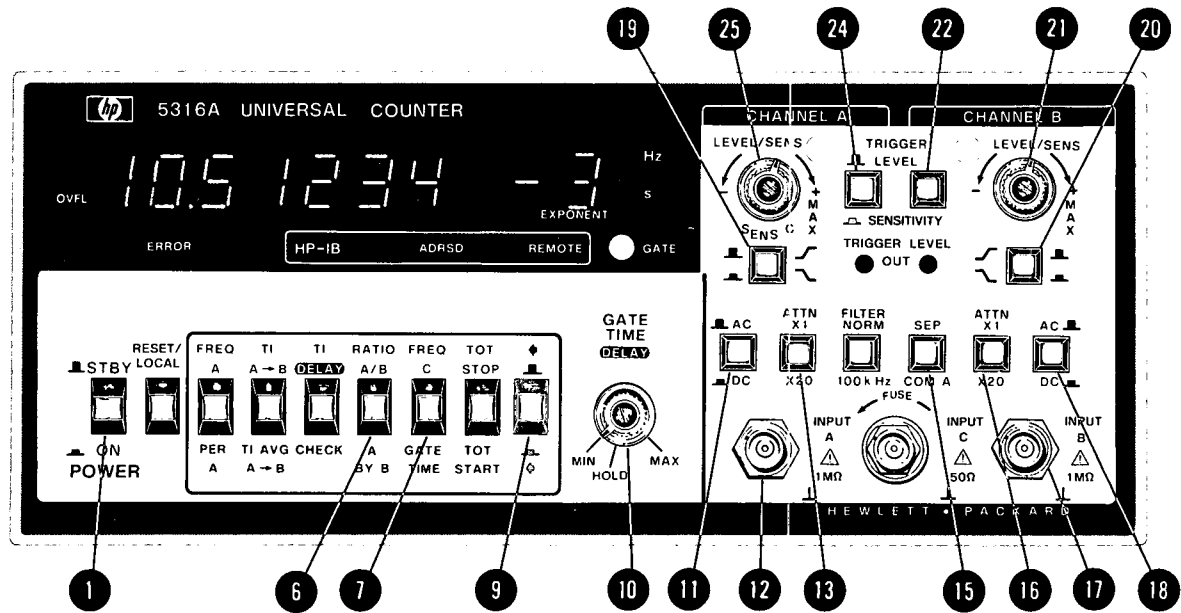

NOTE

For specifications concerning bandwidth, accuracy, and amplitude on input signals, refer to Table 1-1.

1. Set POWER switch 1 to the ON position.
2. Set SEP/COM A switch 15 to SEP position.
3. Connect the input signals to INPUT A 12 and INPUT B 17. Connect the higher frequency signal to INPUT A. Connect the lower frequency signal to INPUT B. The ratio displayed will be greater than 1.
4. Press RATIO A/B 6, and insure the Blue Shift key 9 is in the out position.
5. Set AC/DC 11 18, ATTN 13 16, and Slope 19 20 switches to desired positions.
6. Set TRIGGER LEVEL/SENSITIVITY switches 22 24 to SENSITIVITY position and LEVEL/SENS controls 21 25 fully ccw. This sets the trigger level at 0 volts (nominally) and sensitivity to minimum (>500 mV).
7. Adjust each LEVEL/SENS control 21 25 in a clockwise direction slightly beyond the point the corresponding trigger light flashes. If signals are less than 250 mV rms, the LEVEL/SENS controls may be fully cw.
8. Adjust the GATE TIME control 10 for desired resolution. The selected gate time, variable nominally from 60 ms to 10 s, may be displayed by pressing the GATE TIME switch 7 and the Blue Shift key 9.

Figure 3-17. Ratio A/B Measurements

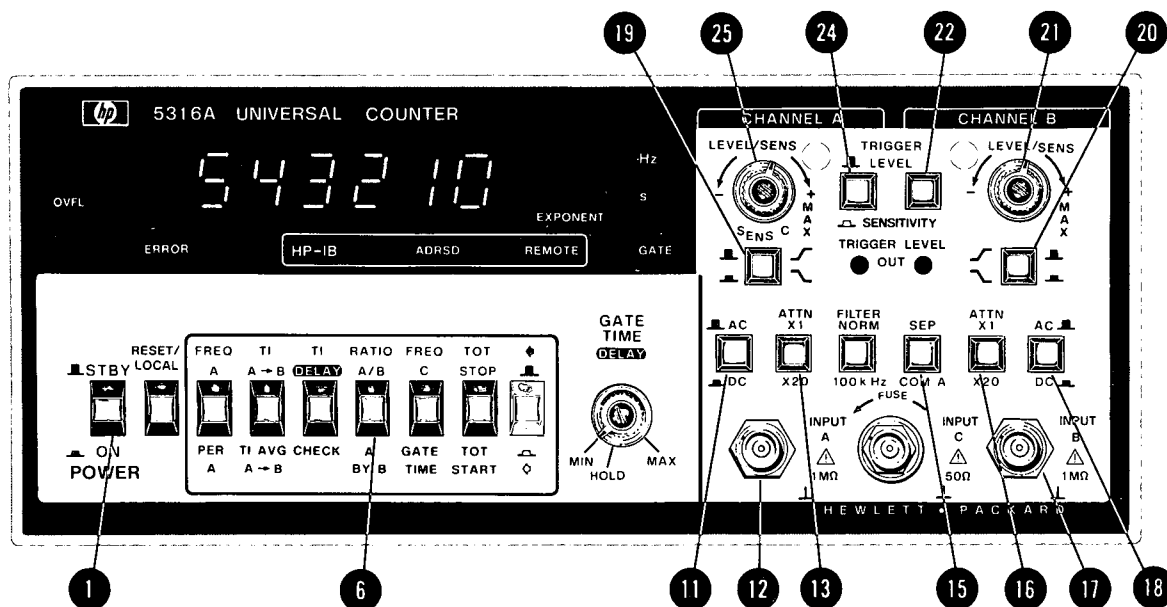

NOTE

For specifications concerning bandwidth, accuracy, and amplitude on input signals, refer to Table 1-1.

1. Set POWER switch **1** to the ON position.
2. Set SEP/COM A switch **15** to SEP position.
3. Connect the signal, either sine wave or pulses, to be totalized to INPUT A jack **12** and the gate control signal to INPUT B jack **17**.

NOTE

This mode will totalize inputs on Channel A for the time between two events on Channel B. The Gate will open on the A Slope setting and close on the B Slope setting. A reset is required to make a new measurement.

4. Press A BY B switch **6** and the Blue Shift key **9** to select the Totalize A BY B function.
5. Set AC/DC **11** **18**, ATTN **13** **16** and Slope **19** **20** switches to desired positions.
6. Set TRIGGER LEVEL/SENSITIVITY switches **22** **24** to SENSITIVITY position and LEVEL/SENS **21** **25** fully ccw. This sets the trigger level at 0 volts (nominally) and sensitivity to minimum (500 mV).
7. Adjust each LEVEL/SENS **21** **25** in a clockwise direction slightly beyond the point the corresponding trigger light flashers. If signals are less than 250 mV rms, the LEVEL/SENS controls may be fully cw.
8. This function operates in a single-shot mode. The RESET key must be pressed to initiate a new measurement.

Figure 3-18. A BY B Measurements

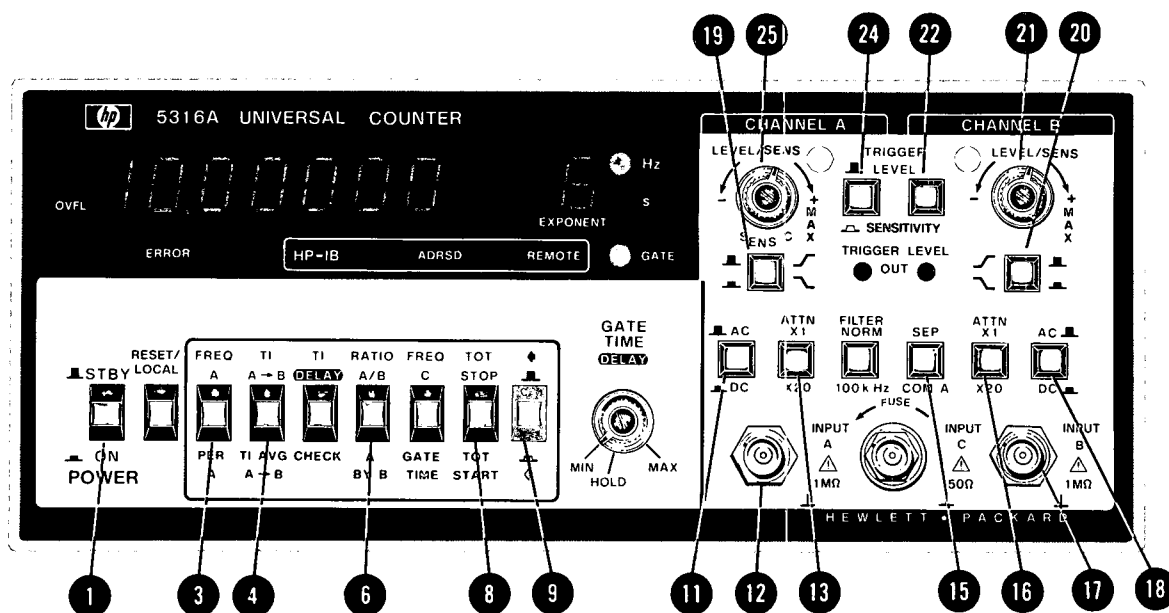

1. Set POWER switch **1** to the ON position.
2. Set SEP/COM A switch **15** to SEP position.
3. Connect the frequency burst signal to be averaged to INPUT A jack **12** and the sampling signal to INPUT B jack **17**. The sampling signal must be synchronized with, and of pulse width less than the burst.

NOTE

This mode will average together multiple frequency bursts and display the average frequency of the signal within the burst. *Due to the complexity of this function it is recommended that the user thoroughly read paragraph 3-23 before attempting to use this function.*

4. Press T.I. DELAY, CHECK switch **4** and RATIO A/B, A BY B switch **6** together for a gate time of 500 μ s-30 ms or FREQ A, PER A switch **3** and TOT STOP, TOT START switch **8** for a gate time of 60 ms-10 s.
5. Set AC/DC **11** **18**, ATTN **13** **16** to the desired positions.
6. Set the Blue Shift key **9** for the desired sampling/measurement interval enable slope: OUT for a positive enable slope, IN for a negative enable slope (negative slope only using SHORT measurement interval).
7. Set the A Channel SLOPE switch **19** to the desired trigger slope. Set the B Channel SLOPE switch **20** for the desired disable slope.
8. Set the TRIGGER/SENSITIVITY switches **22** **24** to SENSITIVITY position and LEVEL/SENS controls **21** **25** fully ccw. This sets the trigger level at 0 volts (nominally) and sensitivity to minimum (500 mV).
9. Adjust each LEVEL/SENS **21** **25** in a clockwise direction slightly beyond the point the corresponding trigger light flashes. If the signals are less than 250 mV, the LEVEL/SENS controls may be fully cw.

Figure 3-19. FREQ A Armed by B Measurements

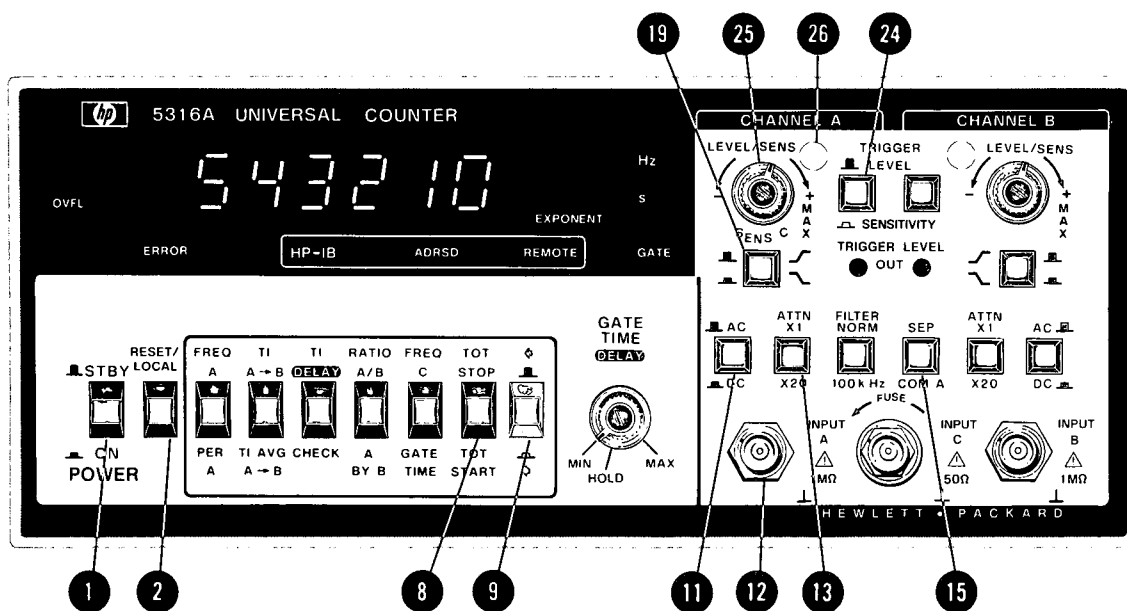

NOTE

For specifications concerning bandwidth, accuracy, and amplitude on input signals, refer to Table 1-1.

1. Set POWER switch 1 to the ON position.
2. Set SEP/COM A switch 15 to SEP position.
3. Connect the signal to be totaled to INPUT A jack 12.

NOTE

This mode will totalize inputs on Channel A for the period of time manually selected using front panel switches.

4. Press TOT switch 8. The Blue Shift key 9 must be in the out position.
5. Set AC/DC 11, ATTN 13 and Slope 19 switches to desired positions.
6. Set TRIGGER LEVEL/SENSITIVITY switch 24 to SENSITIVITY position and LEVEL/SENS 25 fully ccw. This sets the trigger level at 0 volts (nominally) and sensitivity to minimum (500 mV).
7. Adjust the LEVEL/SENS control 25 in a clockwise direction slightly beyond the point the Channel A trigger light 26 flashes.
8. Press RESET 2 to clear display.
9. Press Blue Shift key 9 IN to START totalize measurement, and press again (OUT position) to STOP totalize. Repeat this procedure to accumulate counts, press RESET 2 to clear display and enable a new measurement.

Figure 3-20. Totalize Measurements

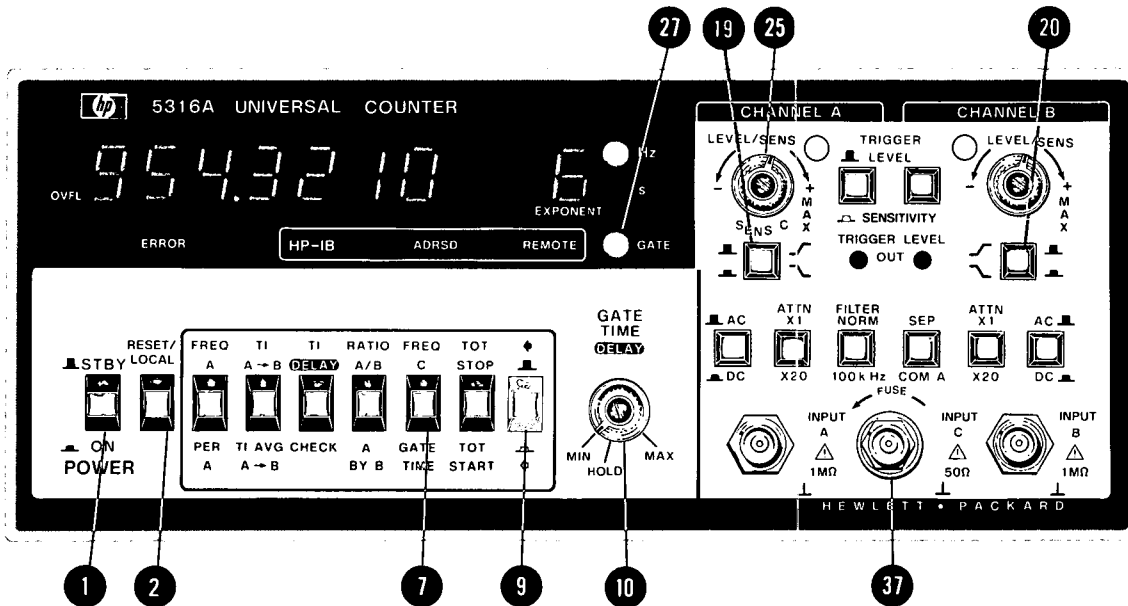

CAUTION

Make sure that the amplitude of the signal does not exceed the 1V rms dynamic range.

NOTE

For specifications concerning bandwidth, accuracy, and amplitude on input signals, refer to *Table 1-1*.

1. Set POWER switch **1** to the ON position, and press FREQ C/GATE TIME **7**.
2. Set GATE TIME control **10** to MIN.
3. Connect the input signal to INPUT C jack **37**.
4. Set SENS C control **25** to MIN. Slowly rotate the control in a cw direction until the GATE light **27** just turns on.
5. Adjust the GATE TIME control **10** for the desired resolution. The actual gate time may be displayed by pressing the GATE TIME function switch **7** and the Blue SHIFT **9**. Moving the GATE TIME control **10** fully ccw into detent will HOLD the measurement display. In HOLD, single-shot measurements with minimum gate time can be made by pressing the RESET **2** key.

NOTE

The only controls active in FREQ C function mode are GATE TIME **10**, RESET **2**, and SENS C **25**. However, pressing either Channel A **19** or B **20** scope switches will reset the counter.

6. The input connector for INPUT C **37** is a special fused BNC. The in-line fuse within the connector is accessible from the front panel. Refer to the Operator's Maintenance, paragraph 3-70, for replacement of fuse.

Figure 3-21. Frequency C Measurement



3-73. REMOTE PROGRAMMING VIA THE HP-IB

3-74. Introduction

3-75. The 5316A Universal Counter is compatible with the Hewlett-Packard Interface Bus (HP-IB). Remote programming is installed as standard equipment and allows the counter to respond to remote control instructions and to output measurement data via the HP-IB. At the simplest level, with no system controller, the 5316A can output data, in the talk only mode, to other devices such as a printer or a digital-to-analog converter. In more sophisticated systems, a computing or other type of controller can remotely program the 5316A to perform a specific type of measurement, trigger the measurement, and output the results.

NOTE

HP-IB is Hewlett-Packard's implementation of IEEE Std. 488-1978, "Standard Digital Interface for Programmable Instrumentation".

3-76. The operator must be familiar with the selected controller (e.g., the 9825A, 9830A, or 9835/45A calculators), the HP-IB, and the manual operation and functional capabilities of the 5316A. The following HP manuals should provide useful background information:

- HP-IB User Guide, 9830A (P/N 59300-90002)
- Hewlett-Packard 9825A Calculator General I/O Programming (P/N 09825-90024)
- Hewlett-Packard 9825A Calculator Extended I/O Programming (P/N 09825-90025)
- Hewlett-Packard 9835A Operating and Programming Guide (P/N 09835-90000)
- Hewlett-Packard 9835A I/O ROM Programming Manual (P/N 09835-90060)
- Hewlett-Packard 9845A Operating and Programming Guide (P/N 09845-90060)
- Condensed Description of the Hewlett-Packard Interface Bus (P/N 59401-90030)
- HP-IB Programming Hints For Selected Instruments (P/N 59300-90005)
- 9825A/5316A Introductory Operating Guide (P/N 5952-7586)
- Hewlett-Packard 9825A Calculator Operating and Programming Manual P/N (09825-90000)
- Hewlett-Packard 9825A String Variable Programming (P/N 09825-90020)

3-77. BUS COMPATIBILITY

3-78. Interface Function

3-79. The capability of a device connected to the bus is specified by its interface functions. These functions provide the means for a device to receive, process, and send messages over the bus. Table 3-2 lists the 5316A interface functions using the terminology of the IEEE 488-1978 standard. These functions are also listed below the rear panel HP-IB connector, as follows:

SH1, AH1, T1, L2, SR1, RL1, PP0, DC1, DT1, C0

The number following the interface function code indicates the particular capability of that function.

Table 3-2. HP-IB Interface Functions

INTERFACE FUNCTION SUBSET IDENTIFIER	INTERFACE FUNCTION DESCRIPTION
SH1	Complete source handshake capability.
AH1	Complete acceptor handshake capability.
T1	Talker (basic talker, serial poll, and talk only mode capabilities)
L2	Listener (basic listener without listen only)
SR1	Service request capability.
RL1	Complete remote/local capability.
PP0	No parallel poll capability.
DC1	Complete device clear capability.
DT1	Device trigger capability.
C0	No controller capability.



3-80. The 5316A operates (as listed in *Table 3-2*) as both a talker and listener. The 5316A output format is the same regardless of the mode (talk only/addressable).

- a. TALK: The 5316A can be addressed to Talk by a controller or by the TALK ONLY switch for use in system without a controller. When addressed as a Talker, the 5316A will send data out to other devices on the bus. This data is the result of a measurement in progress when addressed, or the next measurement, depending on the function selected. The Talk Only switch and the HP-IB address switches are located on the rear panel. (See *Figure 3-11*).

NOTE

To remove the 5316A from the TALK ONLY mode, set the ADDRESSABLE/TALK ONLY switch to ADDRESSABLE and press RESET (front panel). When RESET is pressed the 5316A will exit the TALK ONLY mode.

- b. LISTEN: When addressed as a Listener, the instrument can accept any number of commands from the controller via the bus. These commands are used to program the instrument operation.
- c. SERVICE REQUEST (SRQ): SRQ can be sent active on the bus at the end of the measurement. The 5316A has the capability to request service asynchronously from the controller in charge of the bus. See "SR" described in Binary Command section, paragraph 3-91.
- d. REMOTE/LOCAL: Normally the 5316A is under front panel (local) control. In order to program the 5316A, it must be placed into Remote. Once in Remote, the programmable functions cannot be affected by front panel control, except the RESET/LOCAL key, which may be used manually to return the 5316A to local control. The RESET/LOCAL key may be disabled with Local-Lockout (LLO). In LLO, the bus command GTL (Go To Local) must be sent to disable LLO.
- e. PARALLEL POLL: The 5316A does not respond to a parallel poll.
- f. DEVICE CLEAR: When a group or selected device clear is received, the instrument resets and makes a new measurement.
- h. DEVICE TRIGGER: When a device trigger is received, the 5316A will reset and make a new measurement.
- i. CONTROLLER: The 5316A cannot act as a controller.

3-81. BUS MESSAGES

3-82. Through bus messages, devices on the bus can exchange control and measurement information. There are 12 basic messages which can be sent over the interface. *Table 3-3* lists each bus message, giving a description of the 5316A response, and examples of the various controllers' implementations of the messages.

3-83. Address Selection

3-84. To use the 5316A in an HP-IB system, first set the rear panel address switches to the desired address. The leftmost switch sets the counter to the ADDRESSABLE mode or the TALK ONLY mode. The ADDRESSABLE mode is used whenever a calculator or other controller is used within the system. TALK ONLY mode is used when the counter is operating under its own control (no controller on bus) and sends its measured result to another device on the bus, such as a printer set to LISTEN ALWAYS.



Table 3-3. Bus Messages

HP-IB MESSAGE	DESCRIPTION/RESPONSE	SAMPLE 9825A (address = 20)	SAMPLE 9835A/45A (address = 20)
DATA	A WAY TO SEND COMMANDS TO 5316A AND RECEIVE MEASUREMENT DATA.	wrt 720, "FN1" red 720, A	OUTPUT 7, 20; "FN1" ENTER 7, 20; A
TRIGGER	STARTS NEW MEASUREMENT. IF THE 5316A IS IN LOCAL, IT WILL REMAIN IN LOCAL AND NO TRIGGER OCCURS.	trg 7	TRIGGER 7
	STARTS NEW MEASUREMENT. IF THE 5316A IS IN LOCAL, THE 5316A WILL GO INTO REMOTE.	trg 720	TRIGGER 7, 20
CLEAR	STARTS NEW MEASUREMENT (ACTS AS RESET).	clr 7 clr 720	CLEAR 7 CLEAR 7, 20
REMOTE	FRONT PANEL FUNCTION AND SLOPE SWITCHES ARE DISABLED; COUNTER DEFAULTS TO FREQUENCY A, ALL SLOPES TO POSITIVE UNLESS PREVIOUSLY PROGRAMMED.	rem 7 rem 720	REMOTE 7 REMOTE 7, 20
LOCAL	RETURNS TO LOCAL (FRONT PANEL) OPERATION.	lcl 7 lcl 720	LOCAL 7 LOCAL 7, 20
LOCAL LOCKOUT	DISABLES FRONT PANEL RESET; ONLY CONTROLLER CAN RETURN 5316A TO LOCAL. NOTE: IF IN REMOTE, FRONT PANEL FUNCTION AND SLOPE SWITCHES ARE ALSO DISABLED.	llo 7	LOCAL LOCKOUT 7
GOTO LOCAL AND CLEAR LOCAL LOCKOUT	5316A RETURNS TO LOCAL (FRONT PANEL) CONTROL; LOCAL LOCKOUT CLEARED.	lcl 7	LOCAL 7
SERVICE REQUEST	5316A WILL REQUEST SERVICE AT END OF MEASUREMENT IF SRQ AND WAIT STATE	rds (720) DEVICE STATUS	STATUS 7, 20
STATUS BYTE	PRESENTS STATUS INFORMATION. BIT 7 IS SET IF SERVICE IS REQUESTED.	rds (7) BUS STATUS	STATUS 7
STATUS BIT	NOT APPLICABLE.		
PASS CONTROL	NOT APPLICABLE.		
ABORT	TERMINATES THE BUS COMMUNICATIONS; TELLS ALL DEVICES TO UNLISTEN; 5316A ADRSD LIGHT WILL GO OFF.	cli 7	ABORTIO 7



3-85. The five rightmost switches, A₅ through A₁, set the TALK and LISTEN addresses of the 5316A when it is used in the ADDRESSABLE mode. Table 3-4 shows all possible address settings and the corresponding ASCII codes for talk and listen. The 5316A is factory set to address 20 as shown in Figure 3-22.

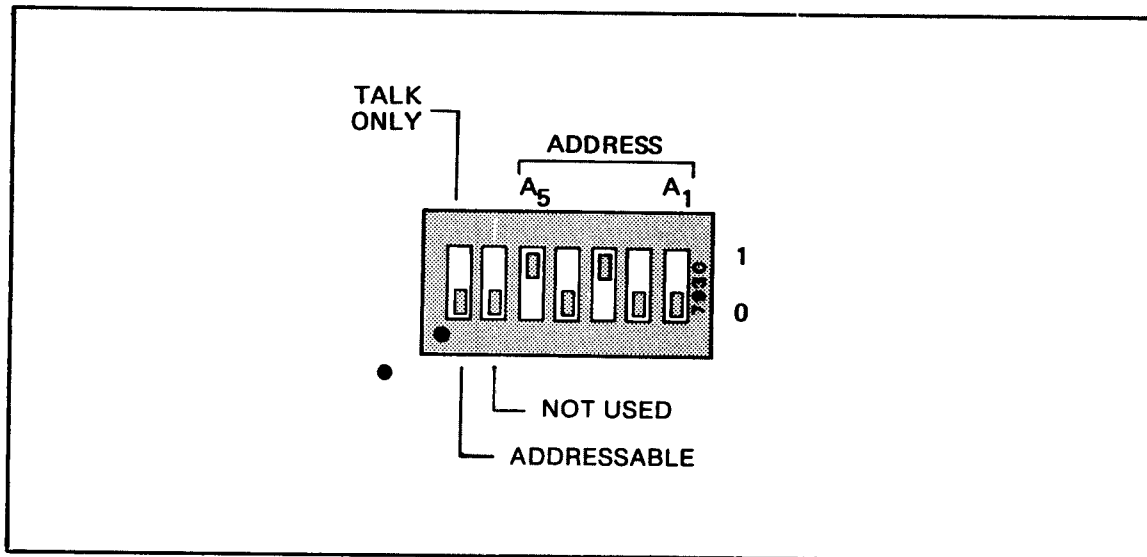

Figure 3-22. 5316A Address Switches (20)

3-86. Front Panel HP-IB Status LEDs

3-87. The two HP-IB Status LEDs on the front panel are to indicate if the counter is in REMOTE and/or ADDRESSED. The REMOTE light is on when the 5316A is in the remote mode. The ADRSD light is on when the 5316A is addressed to talk or listen. When the 5316A goes to local mode, the front panel REMOTE indicator goes off. The ADRSD indicator stays illuminated if the 5316A is still addressed. When in the TALK ONLY mode the ADRSD LED is always illuminated.

NOTE

The TALK ONLY mode may be entered by the rear panel switch, but can be exited only by setting the switch to ADDRESSABLE and pressing the front panel RESET key.

3-88. Device Command D

3-89. A device command is a string or sequence of two or more ASCII-coded bytes (upper or lower case), ending with a delimiter. (A delimiter is either a comma, semicolon, space, carriage return, or linefeed.) This command causes the counter to perform a specific function. For the 5316A these commands can be classified as either Terse, Binary, or Numeric commands.

3-90. TERSE COMMANDS: A sequence of two ASCII-coded alphabetic characters NOT followed by a numeric or binary number.

RE	Reset	Causes display to blank and a new measurement to be made. All functions and parameters remain the same. RESET (RE) also occurs after the 5316A is placed into Remote. The "RE" command is equivalent to the bus Device Clear and Trigger commands. The RESET (RE) command may be used to initiate a new measurement.
----	-------	--



Table 3-4. Address Selection

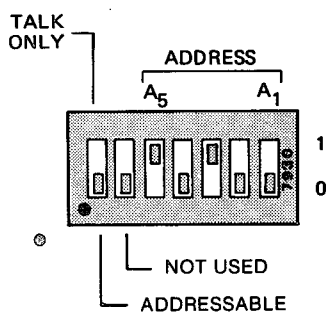

Address "20" Shown

NOTE

Select the listen address from the table below and set the address switches to the corresponding positions.

ASCII CODE CHARACTER	ADDRESS SWITCHES					5-BIT DECIMAL CODE	
	LISTEN	A5	A4	A3	A2		A1
SP		0	0	0	0	0	00
!		0	0	0	0	1	01
"		0	0	0	1	0	02
#		0	0	0	1	1	03
\$		0	0	1	0	0	04
%		0	0	1	0	1	05
&		0	0	1	1	0	06
'		0	0	1	1	1	07
(0	1	0	0	0	08
)		0	1	0	0	1	09
*		0	1	0	1	0	10
+		0	1	0	1	1	11
,		0	1	1	0	0	12
-		0	1	1	0	1	13
.		0	1	1	1	0	14
/		0	1	1	1	1	15
Ø		1	0	0	0	0	16
1		1	0	0	0	1	17
2		1	0	0	1	0	18
3		1	0	0	1	1	19
4		1	0	1	0	0	20
5		1	0	1	0	1	21
6		1	0	1	1	0	22
7		1	0	1	1	1	23
8		1	1	0	0	0	24
9		1	1	0	0	1	25
:		1	1	0	1	0	26
;		1	1	0	1	1	27
<		1	1	1	0	0	28
=		1	1	1	0	1	29
>		1	1	1	1	0	30

Address "21" is address for 98034A and cannot be used.



IN Initialize Causes the 5316A to go to the default state: Function goes to FREQUENCY A, A and B slopes go to +, and all of the Binary commands go to the 0 state. For example, Initialize (IN) sets the following codes:

FN1AS0BS0TR0WA0SR0GA0

The 5316A will blank the display and make a new measurement in **FREQ A**. (NOTE: Even if the 5316A was in **FREQ A** already, "IN" will still set the Binary commands to 0 and make a new measurement. Initialize is commonly sent as the leading code in a command string. This will clear all functions (to default states) and then only the codes following in the command string change the operating mode from the default states..

3-91. BINARY COMMANDS: A sequence of two ASCII-coded alphabetic characters followed by either a '0' or a "1". Blue indicates the default state.

AS0 Channel A triggers on POSITIVE slope of signal.

AS1 Channel A triggers on NEGATIVE slope of signal.

BS0 Channel B triggers on POSITIVE slope of signal.

BS1 Channel B triggers on NEGATIVE slope of signal.

TR0 The A and B trigger levels are set by front panel controls.

TR1 The A and B trigger levels are set by the internal D-to-A Converters. If no numeric values are specified after a TR1 the DACs go to nominal zero volts DC. (See Numeric Commands paragraph 3-92b).

WA0 Continuous gating mode; output only if addressed to talk.

WA1 Gate once, wait for talk address; output data; then make new measurement.

In the Wait state (WA1), the 5316A will make a measurement and hold the data until it has been addressed to talk. At that time, it will output the data and then make a new measurement. None of the functions or parameters are changed. Note that WA1 allows you to make a measurement and then get the data from that measurement. Simply addressing it to Talk, in WA0, will send you the results of the next measurement completed. WA0 will continue gating and not hold the measurement.

SR0 5316A WILL NOT pull SRQ at end of measurement.

SR1 5316A WILL pull SRQ at end of measurement.

The 5316A will request service only to indicate that a measurement is complete and the data is available. Service Request will occur only if:

1. the "SR1" command has been sent.
2. the WAIT state (WA1) has been enabled.

Reading a device status will return the value 64 (seventh bit active) indicating that service has been requested. The service request line is cleared when the 5316A is addressed to TALK or when the status is read. Even though SRQ is cleared during a read device status, the status will remain "64" until the data is read or a front panel RESET is sent.

Once the data is read (when service has been requested) SRQ will go inactive and the 5316A will start a new measurement. The service request can only be cleared by reading the measurement data.



3-92. NUMERIC COMMANDS: A sequence of two ASCII-coded alphabetic characters followed by a sequence of bytes representing a decimal number and a delimiter. Blue indicates the default states.

a. Measurement Functions:

- FN0 ROLLING DISPLAY TEST
- FN1 FREQUENCY A
- FN2 TIME INTERVAL A→B
- FN3 TI DELAY
- FN4 RATIO A/B
- FN5 FREQUENCY C
- FN6 TOTALIZE STOP
- FN7 PERIOD A
- FN8 TIME INTERVAL AVERAGE A→B
- FN9 CHECK 10.00 MHz
- FN10 A GATED BY B (trigger slope controlled by front panel or by commands AS and BS).
- FN11 READ GATE TIME
- FN12 TOTALIZE START
- FN13 FREQUENCY A, AVERAGED, ARMED BY B
FN13 sets the Channel B START arming slope to positive trigger. The STOP slope is determined by sending BS0 or BS1. The Channel A slope is determined by AS0 or AS1. See paragraph 3-23 for a detailed description of this function.
- FN14 FREQUENCY A, AVERAGED, ARMED BY B
Same as FN13 except the B START arming slope is negative. The B STOP arming slope and Channel A slopes are still determined by BS0 or BS1 and AS0 or AS1, respectively. See paragraph 3-23.

FUNCTION 13 AND 14 A ARMED BY B CODE TABLE

TRIGGER ON A SLOPE	BEGIN ON B SLOPE	END ON B SLOPE	CODE STRING
POS	POS	POS	FN13AS0BS0
NEG	POS	POS	FN13AS1BS0
POS	NEG	POS	FN14AS0BS0
NEG	NEG	POS	FN14AS1BS0
POS	POS	NEG	FN13AS0BS1
NEG	POS	NEG	FN13AS1BS1
POS	NEG	NEG	FN14AS0BS1
NEG	NEG	NEG	FN14AS1BS1

FN16 HP-IB INTERFACE TEST (Used only in the HP-IB verification in Section IV)

b. Programming Trigger Levels:

Commands of the form AT [value] and BT [value] set the D-to-A converters to DC voltages such that the trigger levels of the A (and B) channels are the value (in volts) specified. Note that TR1 must also be sent at the beginning of the DAC programming sequence. (TR1 enables the AT/BT command and need be sent only once.) The trigger level voltage range is +2.50V dc to -2.50V dc, in steps of 0.01V dc. The trigger level voltages may be monitored at the front panel TRIGGER LEVEL jacks. The measurement error at these points is ±5% of the actual voltage ±15 mV over the range of ±2.0V dc. For example all three of the following formats set the Channel A trigger level to 0V dc:

- AT 0 (Here the space is ignored)
- AT0.00
- AT +00



Channel B is exactly the same. To set Channel B to -1.53V:

BT-1.53

Unless specified as negative, the polarity is assumed to be positive.

Sending trigger level commands (AT and/or BT) will cause the 5316A to reset.

c. Programming Gate Time:

GA There are 2 gate time ranges available. The LONG gate time range is 60 ms–10 s, typical. The SHORT gate time range is 500 μ s–30 ms, typical. These two gate time ranges can be controlled by either the front knob or rear panel adjustment (see *Figure 3-11*). The rear panel gate time control is essentially the same as the front panel GATE TIME control WITHOUT the HOLD position. Commands for the gate time ranges are as follows. Blue indicates the default states.

- GA0 Gate time range is LONG, controlled by front knob.
- GA1 Gate time range is SHORT, controlled by front knob.
- GA2 Gate time range is LONG, controlled by rear panel adjustment.
- GA3 Gate time range is SHORT, controlled by rear panel adjustment.

NOTE

Placing the GATE TIME/DELAY control in the HOLD position will cause the bus to stop all operations whenever an attempt is made to read data from the 5316A. When a read data statement is sent, the 5316A cannot send out its data until the GATE TIME/DELAY control is removed from the HOLD position.

3-93. INPUT CODE FORMAT

3-94. The 5316A will accept the program codes in either upper case or lower case. For example (in 9825A HPL language):

wrt 720, "INFN7WA1SR1" OR wrt 720, "infn7wa1sr1"

Either way will produce the same results. Depending on the controller, this feature can help speed the writing of programs.

3-95. OUTPUT FORMAT

3-96. After a measurement is complete, the 5316A will output the data to the HP-IB. The output string contains 19 characters, followed by a carriage return and line feed. *Table 3-5* shows the output format of the string.

3-97. The measurement data output speed for the 5316A is approximately:

- a. Seven measurements/second in the LONG gate time mode with the GATE TIME control fully counterclockwise (shortest LONG gate time), but not in HOLD.
- b. Ten measurements/second in the SHORT gate time mode with the GATE TIME control in the fully counterclockwise position (shortest SHORT gate time), but not HOLD.

3-98. PROGRAMMING EXAMPLES

3-99. The examples listed in this section assume a 5316A address setting of 10100. The 5316A is addressed to talk and listen by using the code 720, where 20 is the 5316A address and 7 is the interface select code of the 98034A. The ASCII characters for these same switch settings are "T" for a talk address and "4" for a listen address; these characters would be used if the controller were an HP 9830A calculator (or 9825A when using the 'cmd' statement).



Table 3-5. Output String Format

1	2	3	through	15	16	17	18	19	20	21
F	+	X spaces, 1 digit, dp, 11-X digits		E	+	D	D	CR	LF	
T	-				-					
O										
X										
SP										

Position 1 (ALPHA CHARACTER):

- F for frequency measurement (FN1, 5, 9, 13, and 14)
- T for time measurement (FN2, 3, 7, 8 and 11)
- O for overflow
- X for error (indicates the same error as front panel ERROR LED). See Section VIII, Troubleshooting.
- SP (space) for all other modes and functions (FN10, 11, 12)

Positions 3 through 15:
In these positions, X spaces followed by a single digit, a decimal point, and 11-X digits (depending on the resolution). The decimal point may appear at any position between 4 and 15.

Position 16 through 21:
The "E" to signify EXPONENT followed by the exponent polarity (+ or -), two exponent digits, and carriage return and linefeed.

3-100. The following programs demonstrate the programming of the 5316A. Examples 1 and 2 are for the 9825A. Examples 3 and 4 are the same as 1 and 2 respectively, but are written for the 9835A/9845A.

EXAMPLE 1 SIMPLE FREQUENCY MEASUREMENT 9825A

```

0:   wrt 720,"FN1"           SET THE 5316A TO FREQUENCY A MODE
1:   red 720,A              READ DATA INTO A
2:   dsp A;wait 500         DISPLAY CONTENTS OF A, WAIT 500 ms
3:   gto 1                  GO TO LINE 1
4:   stp                    STOP

```

EXAMPLE 2 PERIOD MEASUREMENT USING REMOTE TRIGGER LEVELS 9825A

```

0:   dim A$[19]             DIMENSION A$ TO 19 CHARACTER LONG
1:   wrt 720,"fn7wa1tr1at-.25" SET THE 5316A TO: PERIOD, WAIT TO OUTPUT,
                                TRIGGER LEVEL SET BY D/A CONVERTER,
                                CHANNEL A TRIGGER LEVEL SET TO -.25V dc
2:   red 720,A$             READ DATA INTO A$
3:   dsp A$; wait 1000     DISPLAY A$;WAIT 1 SECOND
4:   gto 2                  GOTO LINE 2
5:   end                   END PROGRAM

```

EXAMPLE 3 SIMPLE FREQUENCY MEASUREMENT 9835A/9845A

```

10  OUTPUT 7,20;"FN1"      SET THE 5316A TO: FREQUENCY A MODE
20  ENTER 7,20;A          READ DATA INTO A
30  DISP A                DISPLAY CONTENTS OF A
40  WAIT 500              WAIT 500 ms
50  GOTO 20               GOTO LINE 20
60  STOP                  STOP

```



EXAMPLE 4 PERIOD MEASUREMENT USING REMOTE TRIGGER LEVELS 9835A/9845A

10	OPTION BASE 1	ALL SUBSCRIPTS START AT 1
20	DIM A\$ [19]	DIMENSION A\$ TO 19 CHARACTERS LONG
30	OUTPUT 7,20; "FN7WA1TR1AT-.25"	SET THE 5316A TO: PERIOD, WAIT TO OUTPUT, TRIGGER LEVEL SET BY D/A CONVERTER, CHANNEL A TRIGGER LEVEL SET TO -.25V dc
40	ENTER 7,20; A\$	READ DATA INTO A\$
50	DISP A\$	DISPLAY A\$
60	WAIT 1000	WAIT 1 SECOND
70	GOTO 40	GOTO LINE 40
80	END	END PROGRAM

See Output Format Paragraph 3-95.

3-101. Special Programming Considerations

3-102. To clarify the programming of the 5316A, the following considerations should be noted:

1. If the 5316A is currently in REMOTE and new commands are sent, the 5316A will reset and begin a new measurement.
2. If the 5316A is sent back to local from remote and then returned to remote again, all previous remote functions (slopes, trigger levels, output mode, etc.) will be retained and reactivated. The gate time, however, is dominated by the locally selected range and must be programmed again if different.
3. If a trigger command (group or select) is sent to the 5316A while under remote control, and the 5316A is currently making a measurement, a new measurement will begin but the gate time is shortened. The gate time will be *approximately* the amount of time remaining from the interrupted measurement. The resolution obtained will be correct for the shortened gate time.
4. If a slope command is sent to the 5316A and no previous function command was sent, the 5316A will default to Frequency A.
5. If new commands are sent to the 5316A while it is waiting to output data (WA1 is active), the new commands will not become active until the data is read from the counter (5316A addressed to talk).
6. The 5316A will remember the trigger level values set during remote control when sent to local. However, if the front panel Reset is pressed while in Local, the trigger level values stored will default to nominal zero and the Trigger Level/DAC selection will default to TR0 (front panel control).
7. When writing instructions, the 5316A will generally ignore the delimiters in the instruction string, as long as they occur BETWEEN complete instructions.
8. To enable Service Request, BOTH WA1 and SR1 must be sent. WA1 can be used alone if Service Request is not desired.



Table 3-6. HP-IB Program Code Set

RE	Reset	Display blanks and a new measurement is made.	
IN	Initialize	5316A goes to default state, which is the same as sending the following codes: FN1 AS0 BS0 TR0 WA0 SR0 GA0 (noted in blue)	
AS0	A channel triggers on POSITIVE slope of signal.		
AS1	A channel triggers on NEGATIVE slope of signal.		
BS0	B channel triggers on POSITIVE slope of signal.		
BS1	B channel triggers on NEGATIVE slope of signal.		
WA0	Continuous gating mode, output only if addressed.		
WA1	Gate once, wait for talk address to output data, then make new measurement.		
SR0	5316A WILL NOT pull SRQ at end of measurement.		
SR1	5316A WILL pull SRQ at end of measurement (must be in wait state WA1).		
GA0	Gate time range is LONG, controlled by front knob.		
GA1	Gate time range is SHORT, controlled by front knob.		
GA2	Gate time range is LONG, controlled by rear panel adjustment.		
GA3	Gate time range is SHORT, controlled by rear panel adjustment. Long gate time range — 60 ms to 10 s, typical. Short gate time range — 500 μ s to 30 ms, typical.		
TR0	The A and B trigger levels are set by front panel controls.		
TR1	Enables the A and B trigger levels to be set remotely via HP-IB. If no numeric AT or BT command is sent, trigger level is zero volts DC nominal. AT (value) A Channel Trigger Level BT (value) B Channel Trigger Level Trigger levels can be set from -2.50V dc to +2.50V dc in steps of 0.01V dc. Format for the voltage value can be any of X, X.XX, +X.X, -X, -X.X, +X.XX, -X.XX, X.X, or +X.		
		Measurement Functions:	
		FN0 ROLLING DISPLAY TEST	
		FN1 FREQUENCY A	
		FN2 T.I. A→B	
		FN3 T.I. DELAY	
		FN4 RATIO A/B	
		FN5 FREQUENCY C	
		FN6 TOTALIZE STOP	
		FN7 PERIOD A	
		FN8 T.I. AVERAGE A→B	
		FN9 CHECK 10.00 MHz	
		FN10 A GATED BY B (trigger slope controlled by commands AS and BS or by front panel).	
		FN11 GATE TIME	
		FN12 TOTALIZE START	
		FN13 FREQUENCY A, AVERAGED, ARMED BY B FN13 sets the B channel START arming slope to positive trigger. The STOP slope is determined by sending BS0 or BS1. The A channel slope is determined by AS0 or AS1.	
		FN14 FREQUENCY A, AVERAGED, ARMED BY B Same as FN13 except the B channel START arming slope is negative.	
		FN16 HP-IB INTERFACE TEST (Used in the HP-IB verification in Section IV).	
		DATA OUTPUT SPEED:	
		7 readings/second maximum — Long Gate Time.	
		10 readings/second maximum — Short Gate Time.	
		Note: As soon as a command is sent to the 5316A a new measurement is triggered.	
		Placing the GATE TIME/DELAY control in the HOLD position will cause the bus to stop all operations whenever an attempt is made to read data from the 5316A.	

SECTION IV PERFORMANCE TESTS

4-1. INTRODUCTION

4-2. The procedure in this section tests the electrical performance of the 5316A using the specifications in *Table 1-1* as the performance standards. The complete performance tests are given in *Tables 4-1* and *4-2*. All tests can be performed without access to the inside of the instrument.

4-3. OPERATIONAL VERIFICATION

4-4. The abbreviated checks given in *Table 4-1* can be performed to give a high degree of confidence that the 5316A is operating properly without performing the complete performance tests. The operational verification should be useful for incoming QA, routine maintenance, and after instrument repair. *Table 4-1* consists of the following:

- I. Self-Check
- II. Channel A Frequency Response/Sensitivity
- III. Channel B Frequency Response/Sensitivity and Ratio A/B
- IV. Time Interval and Time Interval Average
- V. Totalize

NOTE

The set-up conditions listed in **BLUE** indicate only those controls have changed position from the previous test.

4-5. PERFORMANCE TESTS

4-6. The performance tests consist of all the tests given in this section as listed below and in *Table 4-2*. These tests verify the specifications in *Table 1-1*. All tests can be performed without access to the interior of the instrument.

- I. Display Test
- II. Self-Check
- III. Gate Time
- IV. Channel A Frequency Response/Sensitivity
- V. Channel B Frequency Response/Sensitivity and Ratio A/B
- VI. Period A
- VII. A By B
- VIII. Time Interval and Time Interval Average
- IX. Totalize
- X. External Reference Oscillator
- XI. Time Interval Delay
- XII. Channel C Frequency Response/Sensitivity

4-7. EQUIPMENT REQUIRED

4-8. Equipment required for the complete test and operational verification is listed in *Table 1-4*. Any equipment which satisfies the critical specification given in the table may be substituted for recommended model numbers.

4-9. TEST RECORD

4-10. Results of the operational verification and performance test may be tabulated on the test cards located at the end of the procedure.

Table 4-1. Operational Verification

The following tests will be performed:

- I. SELF-CHECK
- II. CHANNEL A FREQUENCY RESPONSE/SENSITIVITY
- III. CHANNEL B FREQUENCY RESPONSE/SENSITIVITY AND RATIO A/B
- IV. TIME INTERVAL AND TIME INTERVAL AVERAGE
- V. TOTALIZE

I. SELF-CHECK

a. Set-Up:

POWER SWITCH ON (IN)
 FUNCTION SELECT T.I. DELAY/CHECK
 FUNCTION SET (Blue Shift Key) IN

b. Verify the 5316A displays 10 MHz, with display resolution controlled by the Gate Time control knob. Resolution should increase with gate time.

c. Record the results on the test card (PASS/FAIL).

II. CHANNEL A FREQUENCY RESPONSE/SENSITIVITY

a. Specifications: 0.1 Hz to 100 MHz.

1. 10 mV rms, sine wave 0.1 Hz-10 MHz, dc coupled.
2. 10 mV rms, sine wave 30 Hz-10 MHz, ac coupled.
3. 25 mV rms, sine wave 10-100 MHz, ac or dc coupled.

b. Set-Up:

FUNCTION SELECT **FREQ A/PER A**
 FUNCTION SET (Blue Shift Key) **OUT**
 GATE TIME/DELAY control fully CCV, but not in HOLD
 CHANNELS A&B TRIG LVL/SENS controls MAX (CW)
 CHANNELS A&B TRIGGER LEVEL/SENSITIVITY SENS (IN)
 CHANNELS A&B SLOPES POS (OUT)
 CHANNELS A&B AC/DC DC (IN)
 CHANNELS A&B ATTN X1/X20 X1 (OUT)
 FILTER NORM/100 kHz FILTER NORM (OUT)
 SEP/COM A SEP (OUT)

c. Connect an HP 3325A Synthesizer/Function Generator, through a 50-ohm feedthrough, to the 5316A Channel A Input BNC connector.

d. Set the HP 3325A for 1 Hz, and then 10 MHz at 10 mV rms. Verify the 5316A displays the correct frequencies.

e. Replace the HP 3325A with an HP 8654A Signal Generator. Set the HP 8654A to 50 MHz and then 100 MHz at 25 mV rms. Verify the 5316A displays the correct frequencies.

f. Record the results on the test card (PASS/FAIL).

III. CHANNEL B FREQUENCY RESPONSE/SENSITIVITY AND RATIO A/B

a. Specifications: 0.1 Hz to 100 MHz.

1. 10 mV rms, sine wave 0.1 Hz-10 MHz, dc coupled.
2. 10 mV rms, sine wave 30 Hz-10 MHz, ac coupled.
3. 25 mV rms, sine wave 10-100 MHz, ac or dc coupled.

b. Set-Up:

FUNCTION SELECT **RATIO A/B -- A BY B**
 FUNCTION SET (Blue Shift Key) **OUT**
 GATE TIME/DELAY control fully CCV, but not in HOLD
 CHANNELS A&B TRIG LVL/SENS controls MAX (CW)
 CHANNELS A&B TRIGGER LEVEL/SENSITIVITY SENS (IN)
 CHANNELS A&B SLOPES POS (OUT)
 CHANNEL A AC/DC **AC (OUT)**
 CHANNEL B AC/DC DC (IN)
 CHANNELS A&B ATTN X1/X20 X1 (OUT)
 FILTER NORM/100 kHz FILTER NORM (OUT)
 SEP/COM A SEP (OUT)

Table 4-1. Operational Verification (Continued)

- c. Connect an HP 3325A Synthesizer/Function Generator, through a 50-ohm feedthrough, to the 5316A Channel B Input BNC. Connect the HP 3325A front panel SYNC OUT, through a 50-ohm feedthrough, to the 5316A Channel A Input BNC.
- d. Set the HP 3325A to 30 Hz at 10 mV rms. Verify the 5316A displays: 1.
- e. Set the HP 3325A to 10 MHz at 10 mV rms. Verify the 5316A displays: 1.000000.
- f. Replace the HP 3325A with an HP 8654A Signal Generator. Connect the HP 8654A front panel RF OUT, through a 50-ohm feedthrough, to the 5316A Channel B Input BNC. Connect the HP 8654A rear panel AUX OUTPUT, through a 50-ohm feedthrough, to the 5316A Channel A Input BNC.
- g. Set the HP 8654A to 100 MHz at 25 mV rms. The 5316A should have a stable display of: 1.0000000.
- h. Record the results on the test card (PASS/FAIL).

IV. TIME INTERVAL AND TIME INTERVAL AVERAGE

NOTE

The 5316A and 3325A time bases shall be locked together. Connect the 5316A rear panel REF IN/OUT to the 3325A EXT REF IN. The 5316A INT/EXT switch remains in INT. If the 3325A has Option 001 High Stability Frequency Reference, the rear panel external jumper between the 10 MHz OUT and the EXT REF IN must be removed before connecting the 5316A reference signal.

- a. Specifications:
 - 1. Time Interval 100 ns to 10⁵ seconds.
 - 2. Time Interval Average 0 ns to 10⁵ seconds.

b. Set-Up:

FUNCTION SELECT	T.I. A-B/T.I. AVG A-B
FUNCTION SET (Blue Shift Key)	OUT
GATE TIME/DELAY control	fully CCW, but not in HOLD
CHANNELS A&B TRIG LVL/SENS controls	MAX (CW)
CHANNELS A&B TRIGGER LEVEL/SENSITIVITY	SENS (IN)
CHANNEL A SLOPE	POS (OUT)
CHANNEL B SLOPE	NEG (IN)
CHANNEL A&B AC/DC	DC (IN)
CHANNEL A ATTN X1/X20	X1 (OUT)
FILTER NORM/100 kHz	FILTER NORM (OUT)
SEP/COM A	COM A (IN)

- c. Connect an HP 3325A Synthesizer/Function Generator, through a 50-ohm feedthrough, to the 5316A Channel A Input BNC.
- d. Set the HP 3325A to 500.013 kHz square wave at 300 mV p-p. The 5316A display should read 1.0 E-6s ±1 count.
- e. Press Function Set (Blue Shift Key) IN. The 5316A display should read 1.000 E-6s ±5 ns.
- f. Change the Channel B Slope to Positive (OUT). The display should read either 2.000 E-6s ±5 ns or 0 E-9s ±5 ns.
- g. Change the Channel A Slope to Negative (IN). The 5316A display should read 1.000 E-6s ±5 ns.
- h. Change the Channel B Slope to Negative (IN). The 5316A display should read 0. E-9 ±5 ns or 2.000 E-6s ±5 ns.
- i. Record the results on the test card (PASS/FAIL).

Table 4-1. Operational Verification (Continued)

V. TOTALIZE

- a. Specification: 0 to 100 MHz.
- b. Set-Up:

FUNCTION SELECT **TOT STOP/TOT START**
FUNCTION SET (Blue Shift Key) **OUT**
GATE TIME/DELAY control fully CCW, but not in HOLD
CHANNELS A&B TRIG LVL/SENS controls **MAX (CW)**
CHANNELS A&B TRIGGER LEVEL/SENSITIVITY **SENS (IN)**
CHANNELS A&B SLOPES **POS (OUT)**
CHANNELS A&B AC/DC **DC (IN)**
CHANNELS A&B ATTN X1/X20 **X1 (OUT)**
FILTER NORM/200 kHz **FILTER NORM (OUT)**
SEP/COM A **SEP (OUT)**

- c. Connect an HP 3325A Synthesizer/Function Generator, through a 50-ohm feedthrough, to the 5316A Channel A Input BNC.
- d. Set the HP 3325A to 1 Hz at 100 mV rms. The 5316A display should read 0.
- e. Press the Function Set (Blue Shift Key) IN. Verify the 5316A is counting at a 1-count/second rate. The trigger LED will also flash at this rate.
- f. Release the Function Set (Blue Shift Key). The 5316A should display the total number of pulses counted. The GATE light should be off.
- g. Record the results on the test card (PASS/FAIL).

OPERATIONAL VERIFICATION TEST CARD

HEWLETT-PACKARD MODEL 5316A
UNIVERSAL COUNTER

Test Performed By _____

Serial Number _____

Date _____

DESCRIPTION	CHECK
I. SELF-CHECK	_____
II. CHANNEL A FREQUENCY RESPONSE/SENSITIVITY	_____
III. CHANNEL B FREQUENCY RESPONSE/SENSITIVITY/RATIO	_____
IV. TIME INTERVAL AND TIME INTERVAL AVERAGE	_____
V. TOTALIZE	_____

Table 4-2. 5316A In-Cabinet Performance Test

The following tests will be included:

- I. DISPLAY TEST
- II. SELF-CHECK
- III. GATE TIME
- IV. CHANNEL A FREQUENCY RESPONSE/SENSITIVITY
- V. CHANNEL B FREQUENCY RESPONSE/SENSITIVITY AND RATIO A/B
- VI. PERIOD A
- VII. A BY B
- VIII. TIME INTERVAL AND TIME INTERVAL AVERAGE
- IX. TOTALIZE
- X. EXTERNAL REFERENCE OSCILLATOR
- XI. TIME INTERVAL DELAY
- XII. CHANNEL C FREQUENCY RESPONSE/SENSITIVITY

I. DISPLAY TEST

- a. Turn the 5316A power ON. Place all FUNCTION SELECT switches in the OUT position, including the Function Set (Blue Shift Key).
- b. Refer to paragraph 3-33 and verify that rolling display is correct.
- c. Record the results on the test card (PASS/FAIL).

II. SELF-CHECK

- a. Set-Up:

FUNCTION SELECT	T.I. DELAY/CHECK
FUNCTION SET (Blue Shift Key)	IN
- b. Verify the 5316A displays 10 MHz, with display resolution controlled by the GATE TIME control knob. The resolution should increase with Gate Time.
- c. Record results on the test card (PASS/FAIL).

III. CHANNEL A FREQUENCY RESPONSE AND SENSITIVITY

- a. Specifications: 0.1 Hz to 100 MHz.
 - 1. 10 mV rms, sine wave 0.1 Hz-10 MHz, dc coupled.
 - 2. 10 mV rms, sine wave 30 Hz-10 MHz, ac coupled.
 - 3. 25 mV rms, sine wave 10-100 MHz, ac and dc coupled.
- b. Set-Up:

FUNCTION SELECT	FREQ A/PER A
FUNCTION SET (Blue Shift Key)	OUT
GATE TIME/DELAY control	fully CCW, but not in HOLD
CHANNELS A&B TRIG LVL/SENS controls	MAX (CW)
CHANNELS A&B TRIGGER LEVEL/SENSITIVITY	SENS (IN)
CHANNELS A&B SLOPES	POS (OUT)
CHANNELS A&B AC/DC	DC (IN)
CHANNELS A&B ATTN X1/X20	X1 (OUT)
FILTER NORM/100 kHz	FILTER NORM (OUT)
SEP/COM A	SEP (OUT)
- c. Connect an HP 3325A Synthesizer/Function Generator, through a 50-ohm feedthrough, to the 5316A Channel A Input BNC.
- d. Set the HP 3325A to the following frequencies at 10 mV rms: 0.1 Hz, 10 Hz, 30 Hz, and 100 Hz.
- e. The 5316A should correctly display all frequencies in this range. (For the range of 0.1 Hz to 0.141 Hz, the OVFL light will be ON and the most significant digit "1" will not be displayed).
- f. Set the Channel A AC/DC switch to AC (OUT). While maintaining a 10 mV amplitude, set the 3325A to 30 Hz, 100 Hz, 500 kHz, and 10 MHz. Verify the 5316A displays the proper frequencies.
- g. Set the HP 3325A to 30 Hz at 5 mV rms. Increase the amplitude of the input signal until the 5316A displays a stable count of 30 Hz.
- h. Record on the test card the minimum amplitude at which the 5316A displays a stable count (VALUE).
- i. Set Channel A to DC coupled (IN).
- j. Replace the 3325A with the HP 8654A Signal Generator. Set the 8654A to 50 MHz, 75 MHz, and 100 MHz. Maintain an amplitude of 25 mV rms. The 5316A should correctly display all frequencies in this range.

Table 4-2. 5316A In-Cabinet Performance Test (Continued)

- k. Set the HP 8654A to 100 MHz to 5 mV rms. Increase the amplitude of the HP 8654A until the 5316A displays a stable count of 100 MHz.
- l. Record on the test card the minimum amplitude at which the 5316A displays a stable count (VALUE).

IV. CHANNEL B FREQUENCY RESPONSE/SENSITIVITY AND RATIO A/B

- a. Specifications: 0.1 Hz to 100 MHz.
 - 1. 10 mV rms, sine wave 0.1 Hz–10 MHz, dc coupled.
 - 2. 10 mV rms, sine wave 30 Hz–10 MHz, ac coupled.
 - 3. 25 mV rms, sine wave 10–100 MHz.
- b. Set-Up:

FUNCTION SELECT	RATIO A/B — A BY B
FUNCTION SET (Blue Shift Key)	OUT
GATE TIME/DELAY control	fully CCW, but not in HOLD
CHANNELS A&B TRIG LVL/SENS controls	MAX (CW)
CHANNELS A&B TRIGGER LEVEL/SENSITIVITY	SENS (IN)
CHANNELS A&B SLOPES	POS (OUT)
CHANNELS A&B AC/DC	DC (IN)
CHANNEL A ATTN X1/X20	X1 (OUT)
FILTER NORM/100 kHz	FILTER NORM (OUT)
SEP/COM A	SEP (OUT)
- c. Connect an HP 3325A Synthesizer/Function Generator, through a 50-ohm feedthrough to the 5316A Channel B Input BNC. Connect the HP 3325A front panel SYNC OUT, through a 50-ohm feedthrough, to the 5316A Channel A Input BNC.
- d. Set the HP 3325A to 10 Hz, 30 Hz, and 10 MHz at 10 mV rms. The 5316A should display a stable ratio of 1. to 1.000000 through the frequency range.
- e. Change Channel B to AC coupled (OUT). Maintaining the 10 mV rms amplitude, set the HP 3325A to 30 Hz, 100 Hz, 500 kHz, and 10 MHz. Verify the 5316A displays: 1. to 1.000000.
- f. Replace the HP 3325A with an HP 8654A Signal Generator. Connect the HP 8654A front panel RF OUT, through a 50-ohm feedthrough, to the 5316A Channel B input BNC. Connect the HP 8654A rear panel AUX OUT, through a 50-ohm feedthrough, to the 5316A Channel A input BNC.
- g. Set Channel B to DC coupled (IN).
- h. While maintaining a 25 mV amplitude, set the HP 8654A to 50 MHz, 75 MHz, and 100 MHz. The 5316A should display a stable ratio from 1.000000 to 1.000000 throughout this frequency range.
- i. Record the results on the test card (PASS/FAIL).

V. PERIOD A

- a. Specification: 10 ns–10⁵ seconds.
- b. Set-Up:

FUNCTION SELECT	FREQ A/PER A
FUNCTION SET (Blue Shift Key)	IN
GATE TIME/DELAY control	fully CCW, but not in HOLD
CHANNELS A&B TRIG LVL/SENS controls	MAX (CW)
CHANNELS A&B TRIGGER LEVEL/SENSITIVITY	SENS (IN)
CHANNELS A&B SLOPES	POS (OUT)
CHANNELS A&B AC/DC	AC (OUT)
CHANNEL A ATTN X1/X20	X1 (OUT)
FILTER NORM/100 kHz	FILTER NORM (OUT)
SEP/COM A	SEP (OUT)
- c. Connect an HP 8654A to 5316A Channel A Input BNC with a 50-ohm feedthrough. Set the HP 8654A to 10 MHz and 100 MHz at 100 mV rms. The 5316A should display: 100 ns at 10 MHz and 10 ns at 100 MHz.
- d. Record the results on the test card (PASS/FAIL).

Table 4-2. 5316A In-Cabinet Performance Test (Continued)

VI. A BY B

a. Set-Up:

FUNCTION SELECT RATIO A/B — A BY B
 FUNCTION SET (Blue Shift Key) IN
 GATE TIME/DELAY control fully CCW, but not in HOLD
 CHANNELS A&B TRIG LVL/SENS controls MAX (CW)
 CHANNELS A&B TRIGGER LEVEL/SENSITIVITY SENS (IN)
 CHANNELS A&B SLOPES POS (OUT)
 CHANNELS A&B AC/DC DC (IN)
 CHANNELS A&B ATTN X1/X20 X1 (OUT)
 FILTER NORM/100 kHz FILTER NORM (OUT)
 SEP/COM A SEP (OUT)

- b. Connect the HP 3325A rear panel 1 MHz REF OUT, through a 50-ohm feedthrough to the Channel A Input BNC.
- c. Set the HP 3325A Synthesizer/Function Generator to 10 kHz square wave at 100 mV p-p. Connect the output of the HP 3325A to the CHANNEL B input BNC through a 50-ohm feedthrough.
- d. Verify the Channel A and B Trigger lights are flashing.
- e. Press the 5316A front panel RESET. The 5316A should display 100.000 ±1 count.
- f. Record the results on the test card (PASS/FAIL).

VII. TIME INTERVAL AND TIME INTERVAL AVERAGE

NOTE

The 5316A and 3325A time bases shall be locked together. Connect the 5316A rear panel REF IN/OUT to the 3325A EXT REF IN. The 5316A INT/EXT switch remains in INT. If the 3325A has Option 001 High Stability Frequency Reference, the rear panel external jumper between the 10 MHz OUT and the EXT REF IN must be removed before connecting the 5316A reference signal.

a. Specifications:

1. Time Interval: 100 ns to 10e5 seconds.
2. Time Interval Average: 0 ns to 10e5 seconds.

b. Set-Up:

FUNCTION SELECT T.I. A-B/T.I. AVG A-B
 FUNCTION SET (Blue Shift Key) OUT
 GATE TIME/DELAY control fully CCW, but not in HOLD
 CHANNELS A&B TRIG LVL/SENS controls MAX (CW)
 CHANNELS A&B TRIGGER LEVEL/SENSITIVITY SENS (IN)
 CHANNEL A SLOPE POS (OUT)
 CHANNEL B SLOPE NEG (IN)
 CHANNELS A&B AC/DC DC (IN)
 CHANNELS A&B FILTER NORM/100 kHz FILTER NORM (OUT)
 SEP/COM A COM A (IN)

- c. Connect an HP 3325A Synthesizer/Function Generator, through a 50-ohm feedthrough, to the 5316A Channel A Input BNC.
- d. Set the HP 3325A to 500.013 kHz square wave at 300 mV p-p. The 5316A should display 1.0 E-6s ±1 count.
- e. Press Function Set (Blue Shift Key) IN. The 5316A should display 1.000 E-6s ±5 ns.
- f. Change the Channel B Slope to Positive (OUT). The 5316A should display either 2.000 E-6s ±5 ns or 0.E-9s ±5 ns.
- g. Change the Channel A Slope to Negative (IN). The 5316A should display 1.000 E-6s ±5 ns.
- h. Change the Channel B Slope to Negative (IN). The 5316A should display 0 E-9 ±5 ns, or 2.000 E-6 ±5 ns.
- i. Record the results on the test card (PASS/FAIL).

Table 4-2. 5316A In-Cabinet Performance Test (Continued)

VIII. TOTALIZE

- a. Specification: 0 to 100 MHz.
- b. Set-Up:

FUNCTION SELECT	TOT STOP/TOT START
FUNCTION SET (Blue Shift Key)	OUT
GATE TIME/DELAY control	fully CCW, but not in HOLD
CHANNELS A&B TRIG LVL/SENS controls	MAX (CW)
CHANNELS A&B TRIGGER LEVEL/SENSITIVITY	SENS (IN)
CHANNELS A&B SLOPES	POS (OUT)
CHANNELS A&B AC/DC	DC (IN)
CHANNELS A&B ATTN X1/X20	X1 (OUT)
FILTER NORM/100 kHz	FILTER NORM (OUT)
SEP/COM A	SEP (OUT)
- c. Connect an HP 3325A Synthesizer/Function Generator, through a 50-ohm feedthrough, to the 5316A Channel A Input BNC.
- d. Set the HP 3325A to 1 Hz at 100 mV rms. The 5316A should display 0.
- e. Press the Function Set (Blue Shift Key) IN. Verify the 5316A is counting at a 1 count/second rate. The trigger LED will also flash at this rate.
- f. Release the Function Set (Blue Shift Key) OUT. The 5316A should display the total number of pulses counted. The GATE light should be OFF.
- g. Record the results on the test card (PASS/FAIL).

IX. GATE TIME

- a. Set the Function Select to **FREQ C/GATE TIME**, and the Function Set (Blue Shift Key) IN. Vary Gate time pot from Min (CCW but not HOLD) to MAX (CW). The 5316A should display:
60 ms to 10 seconds nominal
- b. Set the Gate Time control to HOLD (detent). The 5316A should stop gating and hold the last measurement. The Gate Light should be OFF.
- c. Record the results on the test card (PASS/FAIL).

X. EXTERNAL REFERENCE OSCILLATOR

- a. Set-Up:

FUNCTION SELECT	FREQ A/PIER A
FUNCTION SET (Blue Shift Key)	OUT
GATE TIME/DELAY control	fully CCW, but not in HOLD
CHANNELS A&B TRIG LVL/SENS controls	MAX (CW)
CHANNELS A&B SLOPE	POS (OUT)
CHANNELS A&B TRIGGER LEVEL/SENSITIVITY	SENS (IN)
CHANNELS A&B AC/DC	AC (OUT)
CHANNELS A&B ATTN X1/X20	X1 (OUT)
FILTER NORM/100 kHz	FILTER NORM (OUT)
SEP/COM A	SEP (OUT)
- b. Connect the HP 3325A to 5316A rear panel REF IN/OUT BNC. Connect the HP 3325A front panel SYNC OUT, through a 50-ohm feedthrough, to the Channel A Input BNC. Set the 5316A rear panel REFERENCE INT/EXT switch to EXT.
- c. Adjust the HP 3325A for 10 MHz at 1 volt rms.
- d. Verify the 5316A display reads EXACTLY 10 MHz.
- e. Repeat steps c and d for 5 MHz and 1 MHz. The display should read EXACTLY 5.000 MHz and 1.0000 MHz, respectively.
- f. Record the results on the test card (PASS/FAIL).
- g. Set the 5316A rear panel REFERENCE INT/EXT switch back to INT.

Table 4-2. 5316A In-Cabinet Performance Test (Continued)

XI. TIME INTERVAL DELAY

a. Specification:

Variable delay: 500 μ s to 30 ms (nominal) between Channel A START and the enabling of Channel B STOP.

b. Set-Up:

FUNCTION SELECT T.I. DELAY/CHECK
 FUNCTION SET (Blue Shift Key) OUT
 GATE TIME/DELAY control fully CCW, but not in HOLD
 CHANNELS A&B TRIG LVL/SENS MAX (CW)
 CHANNELS A&B TRIGGER LEVEL/SENSITIVITY SENS (IN)
 CHANNELS A&B AC/DC COUPLING AC (OUT)
 CHANNEL A SLOPE POS (OUT)
 CHANNEL B SLOPE NEG (IN)
 FILTER NORM/100 kHz FILTER NORM (OUT)
 SEP/COM A COM A (IN)

- c. Connect an HP 3325A Synthesizer/Function Generator, through a 50-ohm feedthrough, to the 5316A Channel A Input BNC.
- d. Set the HP 3325A to 250 Hz at 100 mV rms. Verify the Channels A and B Trigger Lights are flashing.
- e. The 5316A should display: 2 E-3.
- f. Slowly increase the GATE TIME control CW. The 5316A should jump from 2 E-3s to 6 E-3s and continue to increase in 4 ms steps to greater than 20 ms.
- g. Record the results on the test card (PASS/FAIL).

XII. CHANNEL C FREQUENCY RESPONSE AND SENSITIVITY

a. Specifications:

- 1. 15 mV rms (-23.5 dBm), 50-650 MHz.
- 2. 75 mV rms (-9.5 dBm), 650 MHz-1 GHz.

b. Set the 5316A front panel controls as follows:

FUNCTION SELECT FREQ C/GATE TIME (IN)
 FUNCTION SET (Blue Shift Key) (OUT)
 GATE TIME/DELAY control fully CCW, but not in HOLD
 CHANNEL A TRIGGER LVL/SENS C fully CW

- c. Connect the HP 8660C/86602A Synthesized Signal Generator, the HP 436A Power Meter, and the 5316A as shown in Figure 4-1.
- d. Set the HP 8660C Signal Generator to 50 MHz. Set output level for -13.5 dBm on the HP 436A Power Meter. Verify the 5316A gates and displays the 50 MHz. Repeat for 150 MHz, 350 MHz, and 650 MHz.
- e. Increase the HP 8660C output level for +.5 dBm on the HP 436A Power Meter. Verify the 5316A gates and displays the proper frequency. Repeat for 900 MHz and 1000 MHz.
- f. Record the results on the test card (PASS/FAIL).

PERFORMANCE TEST CARD

HEWLETT-PACKARD MODEL 5316A
UNIVERSAL COUNTER

Test Performed By _____

Serial Number _____

Date _____

DESCRIPTION	CHECK
I. DISPLAY TEST (PASS/FAIL)	_____
II. SELF CHECK (PASS/FAIL)	_____
III. CHANNEL A FREQUENCY RESPONSE AND SENSITIVITY	
30 Hz-10 mV sensitivity specification (VALUE)	_____
100 MHz-10 mV sensitivity specification (VALUE)	_____
IV. CHANNEL B FREQUENCY RESPONSE/SENSITIVITY AND RATIO A/B (PASS/FAIL)	_____
V. PERIOD A (PASS/FAIL)	_____
VI. A BY B (PASS/FAIL)	_____
VII. TIME INTERVAL AND TIME INTERVAL AVERAGE (PASS/FAIL)	_____
VIII. TOTALIZE (PASS/FAIL)	_____
IX. GATE TIME (PASS/FAIL)	_____
X. EXTERNAL REFERENCE OSCILLATOR (PASS/FAIL)	_____
XI. TIME INTERVAL DELAY (PASS/FAIL)	_____
XII. CHANNEL C FREQUENCY RESPONSE/SENSITIVITY (PASS/FAIL)	_____

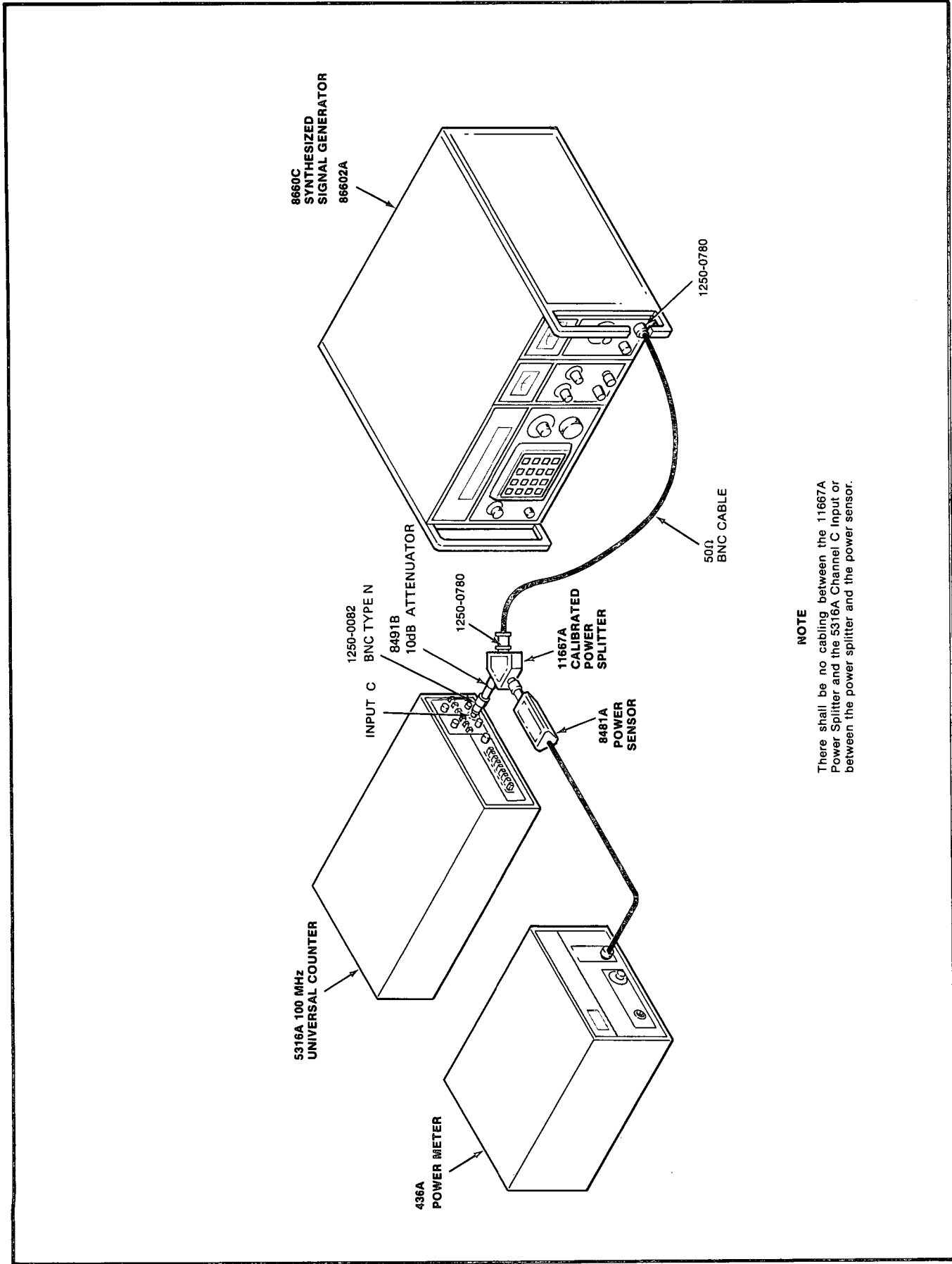

NOTE
There shall be no cabling between the 11667A Power Splitter and the 5316A Channel C Input or between the power splitter and the power sensor.

Figure 4-1. Channel C Test Setup



4-11. HP-IB VERIFICATION

4-12. The 9825A program listed in *Table 4-3* exercises the 5316A through its various operating modes via the HP-IB. A checkpoint is also provided for Option 003 C Channel.

NOTE

The HP-IB verification requires a 98034A HP-IB Interface Card, and 9825A with a 98210A String-Advanced Programming ROM, and one of the following I/O ROMS: 98213A General I/O-Extended I/O ROM, 98214A Plotter-General I/O ROM. A 9825B contains all the necessary ROMs and may be substituted for the above 9825A.

4-13. Checkpoint 1 is an internal software test between the HP-IB microcomputer, the HP-IB interface, and the 9825A. If the 5316A passes this test, there is a high probability that the total HP-IB link is operating properly. (It does not check the A6 Digital-to-Analog Converter, only the capability of the 5316A to accept trigger commands.) If Checkpoint 1 is failed, the 98034A Interface may be defective. If the 98034A appears to be operating correctly, suspect A1U10 (6801) and/or A1U12 (68488). See paragraph 8-56.

4-14. To perform the HP-IB verification, connect the 5316A and 9825A as shown below.



4-15. The program listed in *Table 4-4* may be keyed into the 9825A or may be loaded from an HP-IB verification cassette, HP Part No. 59300-10001 (Revision L or later) which also contains other HP-IB verification programs for other HP instruments. To run the program, insert the cassette into the 9825A. Turn the power ON and file 0 will be automatically loaded and run. When the instrument model number is requested, enter "5316". The 9825A will then load into memory the 5316A verification program.

4-16. After each checkpoint there will be a "cont or repeat?" prompt on the 9825A display. Either press  to go to the next test, or enter cont "X" (where X is the checkpoint to be repeated)

and press .

4-17. At the end of the HP-IB verification, the option is given to repeat any checkpoint.

4-18. Use the following procedure if it is desired to run a specific test within the HP-IB verification:

1. Load the tape in the normal manner.
2. Press , and enter the HP-IB select code.
3. Go through the set-up conditions. pressing  after each prompt.
4. After "TURN POWER OFF/ON" prompt, type [cont "X"]; where X is the checkpoint number to be repeated. Press .

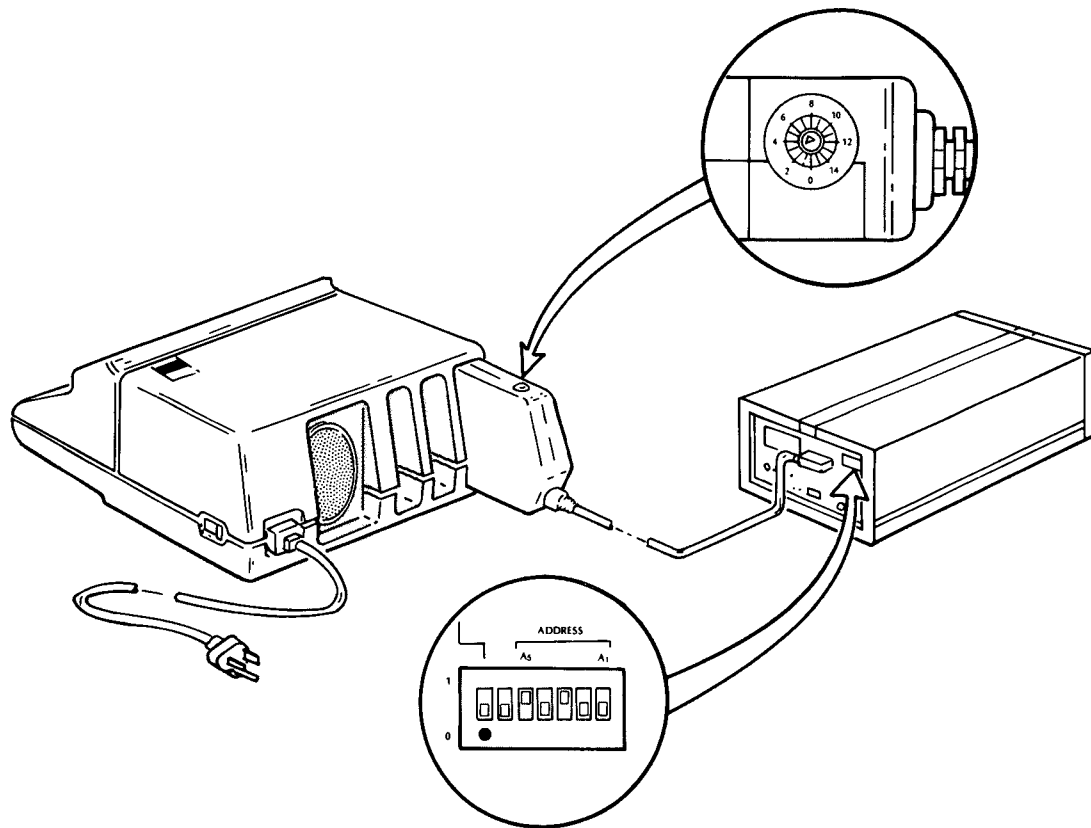

Table 4-3. HP-IB Verification

1. Set-Up:

FUNCTION SELECT	FREQ A/PER A
FUNCTION SET (Blue Shift Key)	OUT
GATE TIME/DELAY control	fully CCW, but not in HOLD
CHANNELS A&B TRIG LVL/SENS control	MAX (CW)
CHANNELS A&B TRIGGER LEVEL/SENSITIVITY	SENS (IN)
CHANNELS A&B SLOPES	POS (OUT)
CHANNELS A&B AC/DC	AC (OUT)
CHANNEL A ATTN X1/X20	X1 (OUT)
FILTER NORM/100 kHz	FILTER NORM (OUT)
SEP/COM A	COM (IN)

2. Connect the rear panel REF IN/OUT to the Channel A input. Checkpoint 5 requires a DVM be connected to the trigger level monitor jack on the front panel.
3. Verify the 5316A is gating and displaying 10 MHz. Both A and B Channel Trigger lights should be flashing.
4. Press RESET on the 9825A, and then press RUN.
5. Enter the three digit select code (7XX), where 7 is the interface select code and XX is the HP-IB address of the 5316A.
6. Press on the 9825A and check the set-up conditions.

NOTE

Any one of the following conditions could cause the 9825A to display; check address/interface:

1. Wrong address entered on the 9825A
2. 5316A is not turned on.
3. Interfacing between the 9825A and the 5316A is defective.



Table 4-3. HP-IB Verification (Continued)

CP#	TEST	PROCEDURE
<p>CHECKPOINT 1 INTERNAL LINK TEST</p> <p>PASS</p>	<p>HP-IB INTERFACE TEST</p>	<p>None (see paragraph 4-11)</p>
<p>CHECKPOINT 2 REMOTE TEST verify: *ADRSD on *REMOTE on</p> <p>LOCAL-LOCKOUT TEST verify: FRONT PANEL RESET HAS NO EFFECT</p> <p>LOCAL TEST verify: *ADRSD on *REMOTE off</p>	<p>REMOTE</p> <p>LOCAL LOCKOUT</p> <p>LOCAL</p>	<p>A. 5316A Remote and Address Lamps should light.</p> <p>B. 5316A Remote and Address Lamps should remain lit. Verify the front panel reset has no effect.</p> <p>C. 5316A should return to LOCAL. Address Lamp should remain lit. Remote Lamp should go OFF. Before continuing, verify the Channel A and B Trigger Lamps are flashing.</p>
<p>CHECKPOINT 3 FREQUENCY= F 1.000000E+07</p> <p>RATIO= 1</p> <p>PASS</p>	<p>FREQUENCY A AND B, RATIO A/B MEASUREMENT</p>	<p>Commands sent to the 5316A; measurement data is read and printed by the 9825A.</p>



Table 4-3. HP-IB Verification (Continued)

CP#	TEST	PROCEDURE
<p>CHECKPOINT 4 SERVICE REQUEST TEST</p> <pre> sra1= 64 PERIOD = +1.00000000e-07 sra2= 0 PASS </pre>	<p>WAIT STATE AND SERVICE REQUEST</p>	<p>Set gate time control to maximum (cw). A period measurement is made; service is requested; data is read by the 9825A. The status is read before and after each measurement.</p> <p>ADRSD lamp should be on. GATE lamp is on during the measurement.</p> <p>After the measurement is complete, set gate time control to minimum (ccw), but not in HOLD.</p>
<p>CHECKPOINT 5 DAC TEST</p> <p>verify: DVM ramps from -2.0V to +2.0V in .2V steps (typical)</p> <p>verify: 5316A has resumed gating and measuring ref signal</p>	<p>REMOTE TRIGGER LEVELS</p>	<p>Channel A — Connect A DVM to the Channel A Trigger Level monitor jack. Observe the DVM. When CONTINUE is pressed, the DVM should begin at -2.0V and then increment in 200 mV steps (typical) until +2.0V is reached.</p> <p>When cycling, the 5316A will display 000. Address and remote lamps will be on. A 10 MHz reading will flash momentarily on the 5316A display in the middle of the trigger level range.</p> <p>Channel B — Move the DVM to the Channel B Trigger Level Monitor jack. Observe the DVM as in Channel A above.</p> <p>At the end of the test, the 9825A will beep. Press CONTINUE and verify the 5316A resumes gating and displaying 10 MHz.</p>
<p>CHECKPOINT 6 GATE TIME TEST</p> <p>PASS</p>	<p>GATE TIME TEST</p>	<p>Two gate time range commands are sent to the 5316A for both front and rear panel controls. The gate times are then measured. Depending on the rear panel gate time setting, this measurement may take up to 30 seconds.</p>

Model 5316A
Performance Tests



Table 4-3. HP-IB Verification (Continued)

CP#	TEST	PROCEDURE
CHECKPOINT 7 OPTION 003 TEST verify: 9825A DISPLAYS FREQUENCY (50MHz→1Ghz) END OF TEST	CHANNEL C TEST OPTION 003	Connect an HP 8660 (or equivalent), to the C Channel input. Slowly vary the frequency from 1 GHz down to 50 MHz and verify the 5316A displays the proper frequency. The 9825A should have the same display as the 5316A. The program will loop, allowing 30 seconds to sweep the oscillator. This test point may be repeated if more time is necessary (refer to paragraph 4-16).



Table 4-4. 5316A HP-IB Verification Program

```

0: dsp "5316A FREQUENCY COUNTER";wait 1000
1: dim A#[21],A[9],B[9],Q[4]
2: "code":ent "ENTER 3 DIGIT SELECT CODE (7XX)",S
3: if S=721;dsp "error:calculator address";wait 2000;sto "code"
4: if S<700 or S>730;dsp "check address/interface";beep;wait 2000;sto "code"
5: fxd 0;cmd S;cll 'c'(X);if X=0;0+S;sto -1
6: dev "5316",S;prt "5316A HP-IB TEST";sec 2
7: dsp "REAR PANEL REF OUT TO CHAN A";stp
8: dsp "REAR PANEL REFERENCE to INT.";stp
9: dsp "SET SEP/COM SWITCH TO COM A";stp
10: dsp "FREQ A/PER A TO FREQ A(IN)";stp
11: dsp "LEVEL/SENS KNOB TO MAX(cw)";stp
12: dsp "GATE TIME TO MIN(ccw)-NOT HOLD";stp
13: dsp "TRIG LEV/SENS BUTTON TO SENS(IN)";stp
14: dsp "ALL OTHER BUTTONS OUT";stp
15: 0+B[1];85+B[2];255+B[4];240+B[5];79+B[6];64+B[3]+B[7]+B[8]+B[9]
16:
17: "1":prt "-----", "CHECKPOINT 1"
18: prt "INTERNAL", "LINK TEST";sec 2
19: for I=1 to 9
20: 0+A[I]
21: next I
22: " "+A#;rem "5316";clr "5316"
23: lcl 7
24: wrt "5316", "fn16"
25: rds("5316")+A[1]
26: rem "5316";esb "SRQ"
27: rds("5316")+A[2]
28: llo 7;esb "SRQ"
29: rds("5316")+A[3]
30: clr "5316";esb "SRQ"
31: rds("5316")+A[4]
32: lcl 7;esb "SRQ"
33: rds("5316")+A[5]
34: clr 7;esb "SRQ"
35: rds("5316")+A[6]
36: wrt "5316", "*U";esb "SRQ"
37: rds("5316")+A[7]
38: wrt "5316", "ow";esb "SRQ"
39: rds("5316")+A[8]
40: wrt "5316", "@0";esb "SRQ"
41: rds("5316")+A[9]
42: wrt "5316", "?0";esb "SRQ"
43: red "5316", A#
44: tra "5316"
45: for I=1 to 9
46: if A[I]#B[I];prt "FAIL";sto 50
47: next I
48: if A#[1,8]#"*Uow@0?0";prt "FAIL";sto 50
49: prt "PASS";sec 2
50: dsp "cont or repeat?";stp
51: sto "2"
52: "SRQ":
53: 0+N
54: if rds(7)>127;ret
55: N+1+N;if N<500;jmp -1
56: prt "FAIL"
57: rem "5316";stp
58:
59: "2":prt "-----", "CHECKPOINT 2"
60: rem "5316";prt "REMOTE TEST"
61: prt "verify:", "*ADRSD on", "*REMOTE on";sec 2
62: dsp "ONCE VERIFIED--press continue"
63: stp

```



Table 4-4. 5316A HP-IB Verification Program (Continued)

```
64: llo 7;prt "LOCAL-LOCKOUT","TEST"
65: prt "verify:","FRONT PANEL","RESET HAS","NO EFFECT";spc 2
66: stp ;dsp "ONCE VERIFIED--PRESS CONTINUE"
67: lcl "5316";prt "LOCAL TEST"
68: prt "verify:","*ADRSD on","*REMOTE off";spc 2
69: dsp "ONCE VERIFIED-cont or repeat?";stp
70:
71: "3";prt "-----","CHECKPOINT 3"
72: wrt "5316","in"
73: red "5316",A#;prt "FREQUENCY=",A#[1,4]&A#[8,19];spc
74: wrt "5316","fn4"
75: red "5316",A;prt "RATIO=",A;spc 2
76: if (pos(A#,"E")>r1)#0;"e"→A#[r1,r1];sto +0
77: if val(A#[2])#1e7;prt "FAIL","FREQ SHOULD","=10MHz";sto 80
78: if A#1;prt "FAIL","RATIO SHOULD=1";sto 80
79: prt "PASS";spc 2;red "5316"
80: dsp "cont or repeat?";stp
81:
82: "4";prt "-----","CHECKPOINT 4"
83: prt "SERVICE","REQUEST TEST";spc 2
84: dsp "TURN GATE KNOB FULLY CW--cont";stp
85: clr "5316";cfa
86: oni 7,"SR1";eir 7
87: wrt "5316","infn7walr1"
88: dsp "waiting for a service request";wait 500;if flg1;sto 97
89: sto -1
90: "SR1":
91: conv 69;101
92: rds("5316")→A;dsp A;prt "sra1=",A
93: red "5316",A#;prt "PERIOD =",A#[4,19]
94: rds("5316")→C;dsp C;prt "sra2=",C;spc
95: sfa 1
96: iret
97: if val(A#[2])#1e-7;prt "FAIL","PERIOD SHOULD","=100ns";sfa 2
98: if A#64;prt "FAIL","sra1 SHOULD=64";sfa 2
99: if C#0;prt "FAIL","sra2 SHOULD=0";sfa 2
100: if not flg2;prt "PASS";spc 2
101: dsp "cont or repeat?";stp
102: dsp "GATE TIME CCW-NOT IN HOLD-cont";stp
103:
104: "5";prt "-----","CHECKPOINT 5"
105: prt "DAC TEST","verify:","DVM ramps","from -2.0v","to+2.0v"
106: prt "in .2v steps","(typical)";spc 2
107: for C=1 to 2
108: if C=1;dsp "DVM to CHAN A TRIG LEVEL OUT TP";stp
109: if C=2;dsp "DVM to CHAN B TRIG LEVEL OUT TP";stp
110: dsp "DAC TEST in process"
111: -2→X
112: fnt f5.2
113: if C=1;wrt "5316","intrlat",X;wait 750
114: if C=2;wrt "5316","bt",X;wait 750
115: X+.2→X
116: if X<2.02;sto -3
117: beep;next C
118: stp ;beep;dsp "DAC test done--press continue"
119: wrt "5316","at0"
120: prt "verify:","5316A has","resumed satine","and measuring","ref signal"
121: spc 2;stp ;dsp "ONCE VERIFIED--cont or repeat"
122:
123: "6";prt "-----","CHECKPOINT 6"
124: rem "5316";flt 7
125: prt "GATE TIME TEST";spc 2
126: wrt "5316","infn11"
127: dsp "gate time test in process"
```



Table 4-4. 5316A HP-IB Verification Program (Continued)

```

128: for X=0 to 3:wrtr "5316","ea",X:wait 100
129: X+1→Y
130: conv 69,101
131: red "5316",A$:wait 500:red "5316",A$
132: val(A$[2])→Q[Y]
133: next X
134: Q[2]→r4
135: max(Q[1],Q[2])→r1
136: max(Q[3],Q[4])→r2
137: sto +1;if r1=r4:sto 144
138: for P=1 to 4
139: if Q[P]=r1:P→r3
140: if Q[P]=r2:P+r3→r3
141: next P
142: sto 144;if r3=4:sto 143
143: prt "PASS":sto +6
144: prt "FAIL"
145: prt "LONG","FP GT=",Q[1]
146: prt "SHORT","FP GT=",Q[2]
147: prt "LONG","RP GT=",Q[3]
148: prt "SHORT","RP GT=",Q[4]
149: spc 2:dsp "ONCE VERIFIED--cont or repeat?":stp
150:
151: "7":ent "Channel C OPTION?(1=Y,0=N)",D
152: if D#0 and D#1:sto -8
153: if D=0:sto "rpt"
154: prt "-----","CHECKPOINT 7","OPTION 003 TEST"
155: prt "verify:","9825A DISPLAYS","FREQUENCY","(50MHz+1Ghz)":spc 2
156: dsp "1 GHz @75 mv rms to CHANNEL C":stp
157: wrtr "5316","ins00fn5"
158: 1→I:for I=1 to 200
159: red "5316",A$:dsp A$
160: next I
161:
162: "rpt":ent "Repeat a Check Point?(1=y,0=n)",Z
163: if Z#1 and Z#0:sto -1
164: if Z=0:sto "end"
165: if Z=1:ent "Check Point Number(1→7)?",N
166: if N<1 or N>7:sto -1
167: jmp N
168: sto "1"
169: sto "2"
170: sto "3"
171: sto "4"
172: sto "5"
173: sto "6"
174: sto "7"
175: "end":prt "END OF TEST","-----":beep:spc 4
176: end
177:
178: "c":
179: rds(7,r2,r3,r4)→p1;if band(p4,6):1→p1:ret
180: 0→p1:ret
*5390

```

SECTION V ADJUSTMENTS

5-1. INTRODUCTION

5-2. This section describes the adjustments required to maintain the 5316A operating characteristics within specifications. Adjustments should be made when required, such as after a performance test failure or when components have been replaced that may affect an adjustment. If the adjustment cannot be made to the value specified, refer to Section VIII, Troubleshooting.

5-3. *Table 5-1* is a list of all adjustable components in the 5316A. The table includes the paragraph for a particular adjustment, the figure showing the adjustment's location, the label of the adjustment, and the order in which the adjustments should be performed.

Table 5-1. Adjustments

PROCEDURE	ADJUSTMENT	COMMENTS
1. Power Supply Adjustments Paragraph 5-10, Figure 5-1	A1R35 A1R27 A1R23	for +5V for -5.2V for +3V
2. Input Offset Adjustments Paragraph 5-12, Figure 5-2	A4R32 A4R1	Channel A Channel B
3. D/A Converter Adjustments Paragraph 5-14, Figure 5-3	A6R1 A6R2 A6R3 A6R4	Channel A Amplitude Channel A Offset Channel B Amplitude Channel B Offset
4. Trigger Level Adjustments Paragraph 5-16, Figure 5-4	A3R3 A3R4	Channel A Channel B
5. Injection-Locked Multiplier Paragraph 5-18, Figure 5-5	A1C45 A1C50	Coarse Adjust Fine Adjust
6. Reference Oscillator Paragraph 5-20, Figure 5-6	A7C4 A7C7	Coarse Adjust Fine Adjust
7. Option 001 TCXO Adjustment Paragraph 5-24, Figure 5-7	A7 ADJ	Frequency Adjust Use at 25°C
8. Option 001 TCXO Adjustment Paragraph 5-25, Figure 5-7	A7 ADJ	Frequency Adjust Use from 0 to 40°C
9. Option 004 Oven Oscillator Paragraph 5-26, Figure 5-8	A13 Coarse A13 Fine	Coarse Adjust Fine Adjust
10. Option 003 Channel C Paragraph 5-28, Figure 5-9	A9L, HY, H, CL	A3/A4 must be removed prior to the Adjustment

5-4. EQUIPMENT REQUIRED

5-5. The test equipment required for the adjustment procedure is listed in *Table 1-4*, Recommended Test Equipment. Substitute instruments may be used if they meet the critical specifications.

5-6. FACTORY SELECTED COMPONENTS

5-7. There are no factory selected components in the 5316A.

5-8. ADJUSTMENT LOCATIONS

5-9. Figures 5-1 through 5-9 illustrate the location of all adjustments and test points used in the 5316A adjustment procedure.

WARNING

MAINTENANCE DESCRIBED HEREIN IS PERFORMED WITH POWER SUPPLIED TO THE INSTRUMENT, AND PROTECTIVE COVERS REMOVED. SUCH MAINTENANCE SHOULD BE PERFORMED ONLY BY SERVICE-TRAINED PERSONNEL WHO ARE AWARE OF THE HAZARDS INVOLVED (FOR EXAMPLE, FIRE AND ELECTRICAL SHOCK). WHERE MAINTENANCE CAN BE PERFORMED WITHOUT POWER APPLIED, THE POWER CORD SHOULD BE REMOVED.

BEFORE ANY REPAIR IS COMPLETED, ENSURE THAT ALL SAFETY FEATURES ARE INTACT AND FUNCTIONING, AND THAT ALL NECESSARY PARTS ARE CONNECTED TO THEIR PROTECTIVE GROUNDING MEANS.

5-10. A1 Power Supply Adjustments

5-11. The 5316A contains three regulated dc supplies which may be adjusted in any order (see Figure 5-1):

- Remove the top cover by removing the screw located at the rear of the 5316A. This screw also secures the strap handle. Slide the top cover backward until it can be freely removed.
- Connect a 3465A DMM to the Test Point labelled +5 and adjust A1R35 for $+5V \pm 0.01V$.
- Connect a 3465A DMM to the Test Point labelled +3 and adjust A1R23 for $+3V \pm 0.01V$.
- Connect a 3465A DMM to the Test Point labelled -5.2 and adjust A1R27 for $-5.2V \pm 0.01V$.
- This completes the power supply adjustments.

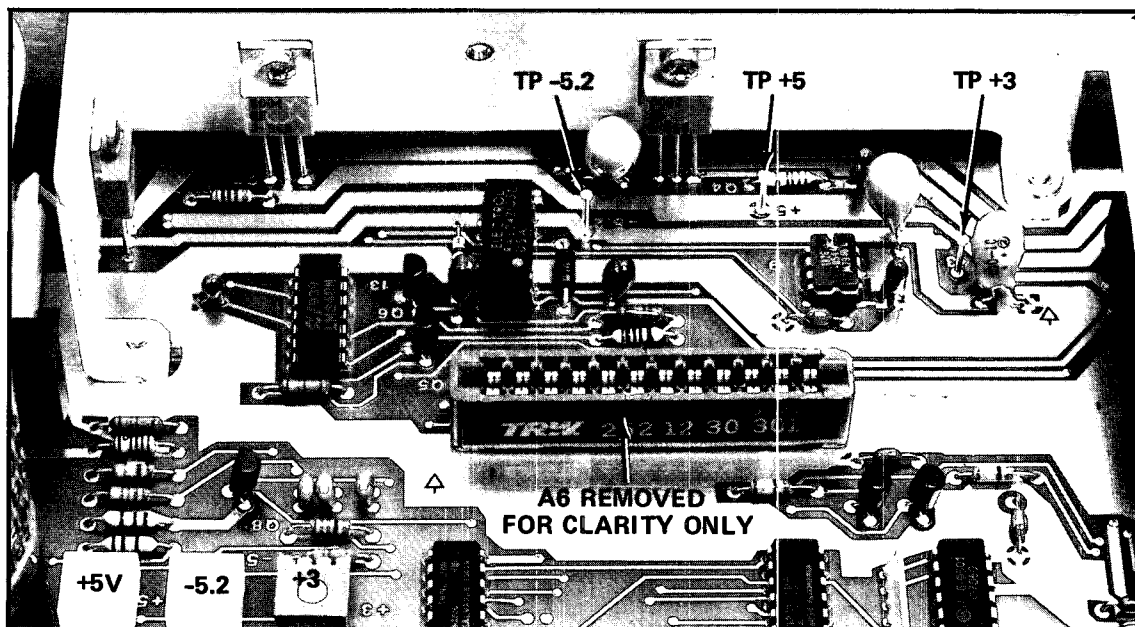

Figure 5-1. Power Supply Adjustment Location

5-12. A4 Input Offset Adjustments

5-13. The input offset adjustments are made to the A4 assembly as follows (see *Figure 5-2*):

- a. Remove the top cover by removing the screw located at the rear of the 5316A. This screw also secures the strap handle. Slide the top cover backward until it can be freely removed.
- b. Connect a 1740A oscilloscope to Pin 5 of A4P2 (not labelled on the assembly).
- c. Connect a 3325A Synthesizer/Function Generator, through a 50-ohm feedthrough, to Channel A Input BNC. Set the 3325A to 10 MHz at 100 mV rms.
- d. Set the Channel A Trigger Level/Sensitivity switch to SENS with the control fully clockwise. The Attenuator and Filter switches should be in the OUT position; the AC/DC switches should be in DC (IN).
- e. Adjust the 1740A oscilloscope for a stable display and then decrease the amplitude of the 10 MHz input signal to the lowest amplitude that maintains a stable display (typically 10 mV rms). If more than 10 mV rms is required, repeat this process following steps e. and f. until less than 10 mV rms is required for a stable display.
- f. Adjust A4R32 for a 50% duty cycle on the 1740A oscilloscope display. A4R32 may require some minor adjustment during the A6 Digital-to-Analog Converter adjustment following in paragraph 5-15.
- g. Connect the 1740A oscilloscope to pin 6 of A4P2 and connect the 10 MHz signal to the Channel B Input (through the 50-ohm feedthrough).
- h. Set the Channel B Trigger Level/Sensitivity switch to SENS with the control fully clockwise. The Attenuator should be in the OUT position.
- i. Adjust the 1740A oscilloscope for a stable display and then decrease the amplitude of the 10 MHz input signal to the lowest amplitude that maintains a stable display (typically 10 mV rms).
- j. Adjust A4R1 for a 50% duty cycle on the 1740A oscilloscope display. A4R1 may require some minor adjustment during the A6 Digital-to-Analog Converter adjustment following in paragraph 5-15.
- k. This completes the offset adjustments for the A4 assembly. The A6 Digital-to-Analog Converter adjustment described in the following paragraphs should now be performed.

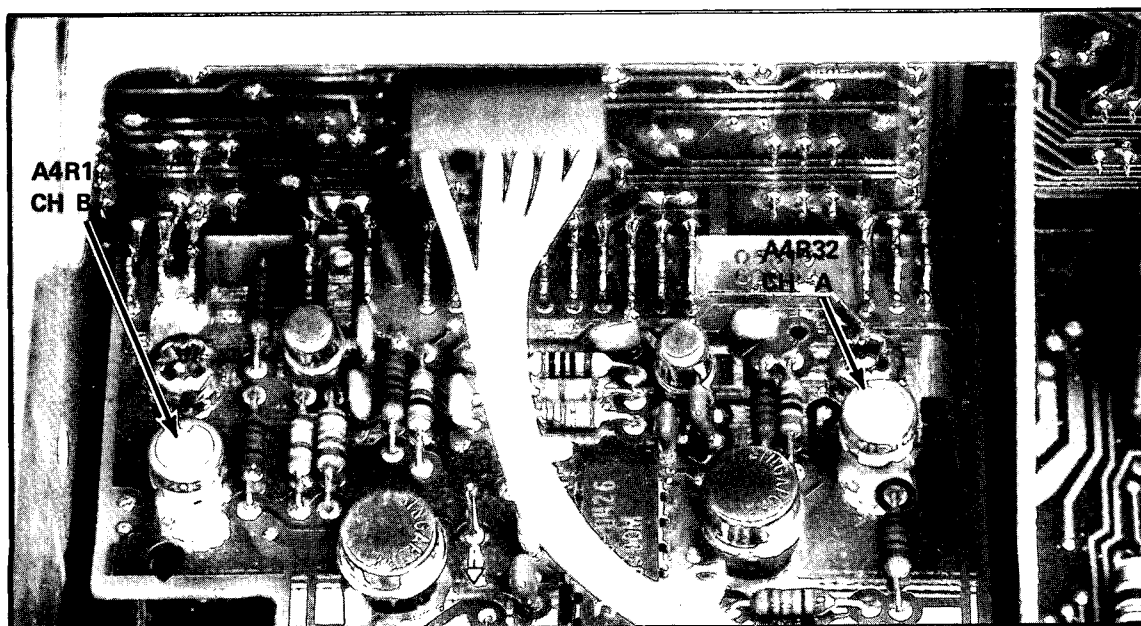

Figure 5-2. A4 Offset Adjustment Location

5-14. A6 Digital-to-Analog Converter Adjustments (Remote Trigger Levels)

5-15. The following A6 D/A Converter adjustment procedure requires a 9825A Calculator/Controller, a 98034A HP-IB Interface Card, and a 98214A General-Extended I/O ROM (a 98213A or 98216A may be substituted for the 98214A). Any suitable controller conforming to IEEE 488-1978 may be substituted for the 9825A system described above (see *Figure 5-3*).

- a. Remove the top cover by removing the screw located at the rear of the 5316A. This screw also secures the strap handle. Slide the top cover backward until it can be freely removed.
- b. Connect a 3465A DMM to the Channel A Trigger Level Out jack on the front panel.
- c. Set both Channels A and B Trigger Level/Sensitivity switches to SENS. Adjust both controls fully clockwise.
- d. Connect the 98034A Interface Cable to the 5316A. Set the 5316A rear panel address switches to Address 00 and ADDRESSABLE (ALL switches in the down position). Set the 98034A select code to "7".
- e. Type into the 9825A the following: `wrt 700, "TR1AT0"` press EXECUTE. Adjust A6R2 (A OS) for $0.000V \pm 0.001V$ on the 3465A DMM display.
- f. Type into the 9825A the following: `wrt 700, "TR1AT2.55"` press EXECUTE. Adjust A6R1 (A AMP) for $2.550V \pm 0.001V$ on the 3465A DMM display.

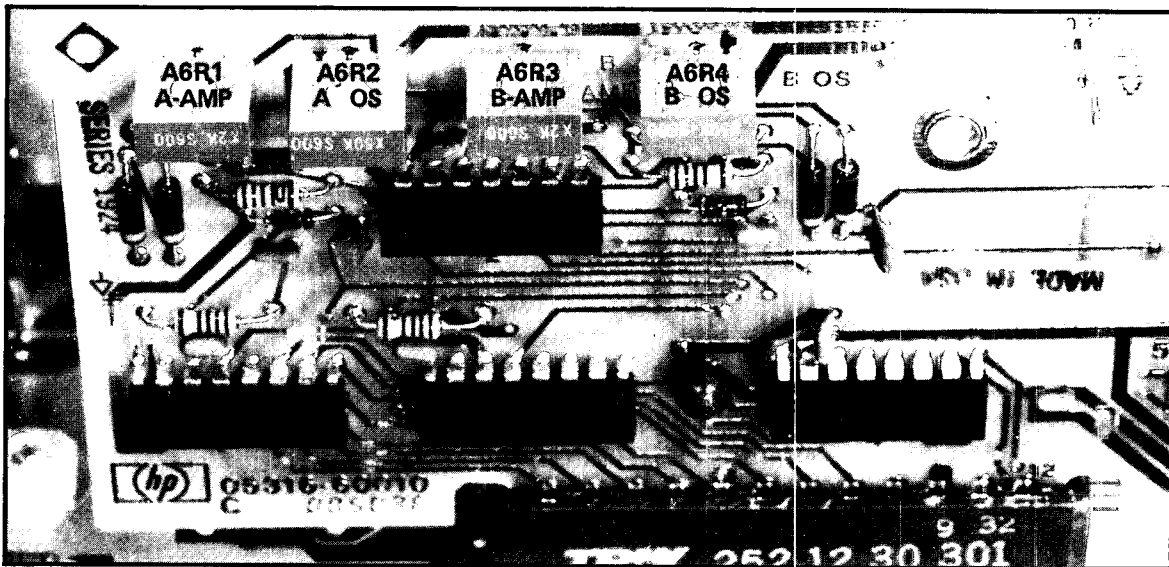

Figure 5-3. Digital-to-Analog Converter Adjustment Location

- g. Type into the 9825A the following: `wrt 700, "TR1AT0"` press EXECUTE. The 3465A DMM should display $0.000V \pm 0.001V$. If not, repeat steps e., f., and g. until it does.
- h. Type into the 9825A the following: `wrt 700, "TR1AT-2.55"` press EXECUTE. The 3465A DMM should now display $-2.550V \pm 0.005$. If it does not, adjust A6R1 (A AMP) until it does, and repeat steps e. through h.
- i. Connect a 3325A Synthesizer/Function Generator set to 10 MHz at 10 mV rms, through a 50-ohm feedthrough, to the Channel A Input BNC. Connect a 1740A oscilloscope to A4P2 pin 5. Adjust A6R2 (A OS) for a 50% duty cycle on the 1740A oscilloscope. The 3465A should display $0.000V \pm 0.005V$. Press the 5316A front panel RESET. Verify the 50% duty cycle does not change. If the duty cycle does change, adjust A4R32 for a 50% duty cycle after RESET on the 5316A has been pressed. A4R32 should require only minor adjustments. Repeat to verify the duty cycle remains 50%.

- j. Connect the 3465A DMM to the Channel B Trigger Level Out jack on the front panel.
- k. Type into the 9825A the following: *wrt 700, "TR1BT0"* press EXECUTE. Adjust A6R4 (B OS) for $0.000V \pm 0.001V$ on the 3465A DMM display.
- l. Type into the 9825A the following: *wrt 700, "TR1BT2.55"* press EXECUTE. Adjust A6R3 (B AMP) for $2.550V \pm 0.001V$ on the 3465A DMM display.
- m. Type into the 9825A the following: *wrt 700, "TR1BT0"* press EXECUTE. The 3465A DMM should display $0.000V \pm 0.001V$. If not, repeat steps k, l, and m until it does.
- n. Type into the 9825A the following: *wrt 700, "TR1BT-2.55"* press EXECUTE. The 3465A DMM should now display $-2.550V \pm 0.005$. If it does not, adjust A6R3 (B AMP) until it does, and repeat steps k. through n.
- o. Connect a 3325A Synthesizer/Function Generator set to 10 MHz at 10 mV rms, through a 50-ohm feedthrough, to the Channel B Input BNC. Connect a 1740A oscilloscope to A4P2 pin 6. Adjust A6R4 (B OS) for a 50% duty cycle on the 1740A oscilloscope. The 3465A should display $0.000V \pm 0.005V$. Press the 5316A front panel RESET. Verify the 50% duty cycle does not change. If the duty cycle does change, adjust A4R1 for a 50% duty cycle after RESET on the 5316A has been pressed. A4R1 should require only minor adjustment. Repeat to verify the duty cycle remains 50%.
- p. This completes the A6 D/A Converter adjustments.

5-16. A3 Trigger Level Gain Compensation

5-17. The following A3 Input Amplifier Gain Compensation procedure requires a 9825A Calculator/Controller, a 98034A HP-IB Interface Card, and a 98214A General-Extended I/O ROM (a 98213A or 98216A may be substituted for the 98214A). Any suitable controller conforming to IEEE 488-1978 may be substituted for the 9825A system described above (see Figure 5-4).

NOTE

Adjustment of the trigger level gain compensation should be performed any time the dual FETs on A4 (Q2 and Q4) are replaced, as this adjustment compensates for their dc gain. Repair or replacement of the A6 DAC assembly, or adjustment of the A4 assembly or A6 DAC Offset Controls, will *generally* not require gain compensation adjustment.

- a. Remove the top cover by removing the screw located at the rear of the 5316A. This screw also secures the strap handle. Slide the top cover backward until it can be freely removed.
- b. Remove the top trim strip from the front frame. Place a flat blade screwdriver into one of the slots of the trim strip and lift upward.
- c. Remove the three screws securing the front panel to the front frame at the top.
- d. Remove the two front feet on the bottom of the 5316A.
- e. Remove the three screws securing the front panel to the front frame at the bottom.
- f. Remove the two hex nuts securing the HP-IB connector to the rear panel.
- g. Remove the hex nut securing the REF IN/OUT BNC to the rear panel.
- h. Remove the screw located between the REFERENCE INT/EXT switch and the PRESET GATE TIME control on the rear panel.
- i. Remove the two screws securing the heatsink/support bracket to the right side frame. Remove the screw securing the A6 DAC assembly stand-off to the right side frame.
- j. Disconnect the secondary of transformer T1 from the A1 Motherboard at connector J7 located just in front of the transformer.

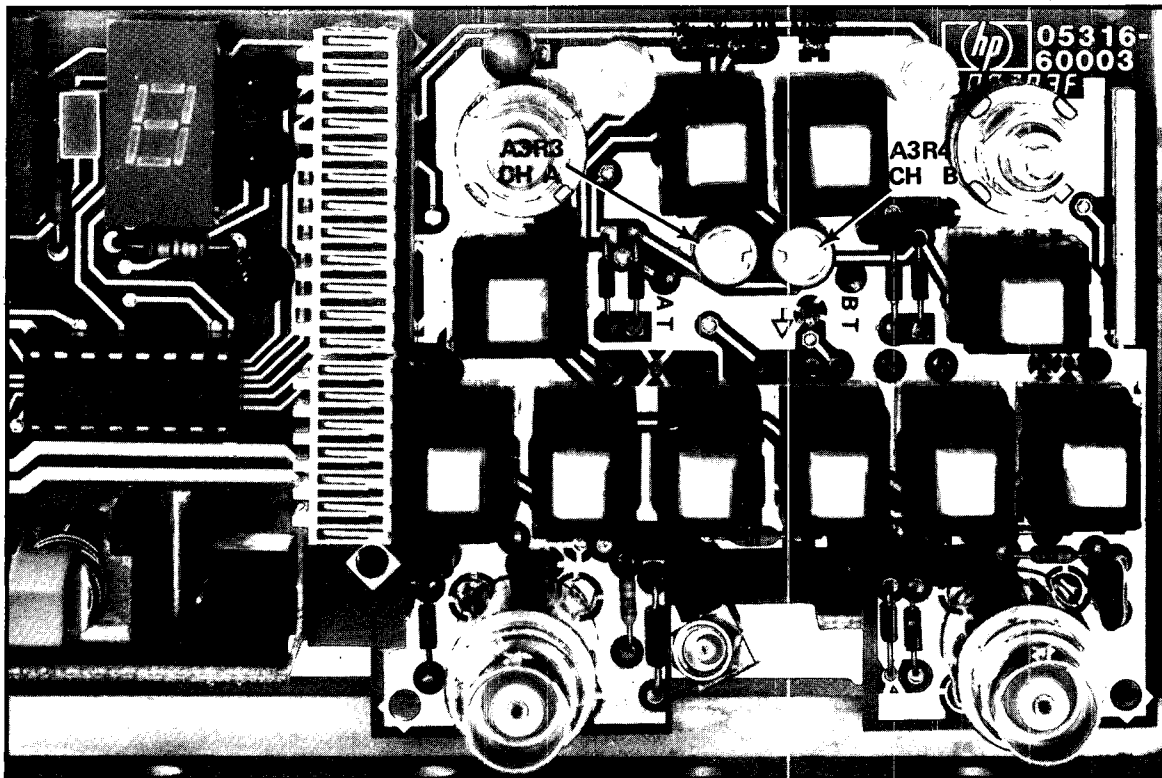

Figure 5-4. Trigger Level Gain Compensation Adjustment Location

- k. Carefully press on the rear of the heatsink and the rear panel BNC and slide the A1 assembly several inches forward through the front frame.
- l. Remove the Trigger Level knobs, the Gate Time knob, the two hex nuts on the Trigger Level controls, and the two hex nuts on the Channel A and B BNC connectors.
- m. Looking at the back of the A2 Display assembly, remove the hex nut located to the right of the assembly (just above the Power STBY/ON switch).
- n. The Channels A and B Trigger Level Monitor jacks are secured to the front panel. Two wires with push-on clips connect them to the A3 Input Amplifier assembly. Pull the front panel forward about 1" and, using long-tipped needle-nose pliers, disconnect the two clips from the A3 assembly. If the 5316A has Option 003 Channel C, disconnect the miniature SMC connector on the rear of the Channel C Input BNC. Remove the front panel.
- o. Slide the 5316A back into the frame and reconnect secondary of T1 to A1J7.
- p. Connect the 98034A Interface Cable to the 5316A rear panel HP-IB Connector. The select code should be set to "7".
- q. Set the 5316A rear panel Address switches to address 00 and ADDRESSABLE (ALL switches in the DOWN position). Set the TRIGGER LEVEL/SENSITIVITY switches to SENS (IN). Set the Trigger Level pots fully CCW.
- r. Using a suitable jumper, connect A6P2 pin 5 to the Channel A Input BNC. Do not disconnect the cable from the A6 assembly. Set Channel A to dc coupled (IN).
- s. Connect a 16-pin IC Test Clip to A4U2.
- t. Connect the PLUS test lead to a floating input 3465A DMM to A4U2 pin 7 and the NEGATIVE test lead to A4U2 pin 8.
- u. Apply power to the 5316A and the 9825A.
- v. Type into the 9825A: `wrt 700, "TR1AT-2.00"` Press EXECUTE.

- w. Adjust A3R3 for $0.000V \pm 0.001$ (zero volts differential between A4U2 pins 7 and 8).
- x. Repeat step v, but program the trigger level for -1.00 , 0.00 , $+1.00$, and $+2.00$ volts. To do this, change the code string "TR1AT-2.00" to "TR1AT-1.00", etc. Verify the 3465A DMM displays $0.000V \pm 5\%$ of the programmed voltage ± 15 mV, for the above voltages. For example, if the programmed voltage is -2.00 volts, then $\pm 5\%$ of -2.00 volts is ± 10 mV. Then adding ± 15 mV yields ± 25 mV. Thus the 3465A DMM should display $0.000V \pm 25$ mV. Listed below are the tolerance limits for the above programmed voltages.

PROGRAMMED VOLTAGES	TOLERANCE
-2.00 Volts	$0.000V \pm 25$ mV
-1.00 Volts	$0.000V \pm 20$ mV
0.00 Volts	$0.000V \pm 15$ mV
+1.00 Volts	$0.000V \pm 20$ mV
+2.00 Volts	$0.000V \pm 25$ mV

- y. Move the jumper to connect A6P2 pin 4 to the Channel B Input BNC. Set Channel B to dc coupling (IN).
- z. Move the PLUS test lead of a floating input 3465A DMM to A4U2 pin 10 and the NEGATIVE test lead to A4U2 pin 9.
- aa. Type into the 9825A: wrt 700, "TR1BT-2.00" press EXECUTE.
- bb. Adjust A3R4 for $0.000V \pm 0.001$ (zero volts differential between A4U2 pin 9 and 10).
- cc. Repeat step t, but program the trigger level for -1.00 , 0.00 , $+1.00$, and $+2.00$ volts. To do this, change the code string "TR1BT-2.00" to "TR1BT-1.00", etc. Verify the 3465A DMM displays $0.000V \pm 5\%$ of the programmed voltage ± 15 mV, for the above voltages. For example, if the programmed voltage is -2.00 volts, then $\pm 5\%$ of -2.00 volts is ± 10 mV. Then adding ± 15 mV yields ± 25 mV. Thus the 3465A DMM should display $0.000V \pm 25$ mV. Listed below are the tolerance limits for the above programmed voltages.

PROGRAMMED VOLTAGES	TOLERANCE
-2.00 Volts	$0.000V \pm 25$ mV
-1.00 Volts	$0.000V \pm 20$ mV
0.00 Volts	$0.000V \pm 15$ mV
+1.00 Volts	$0.000V \pm 20$ mV
+2.00 Volts	$0.000V \pm 25$ mV

- dd. Remove the power from the 5316A and disconnect the jumper.
- ee. Reconnect the Trigger Level Monitor jacks to the A3 assembly. The A3 assembly is marked AT and BT. Do not reverse these connections.
- ff. Reinstall the front panel by performing steps a. through n. in reverse order.
- gg. This completes the A3 Trigger Level Gain adjustments.

5-18. A1 Injection-Locked Multiplier Adjustment

- 5-19. The following adjustments set the lock range of the external reference input (see Figure 5-5).
- a. Remove the top cover by removing the screw located at the rear of the 5316A. This screw also secures the strap handle. Slide the top cover backward until it can be freely removed.
 - b. Remove the two hex head screws securing the A12 HP-IB Interface assembly to the rear panel. Remove the screw located in the center of the A12 assembly securing the A12 to a standoff on the A1 Motherboard. Disconnect the ribbon cable connecting A12 to A1. Remove the A12 assembly. The adjustments for the Injection-Locked Multiplier are located under the removed A12 assembly at the rear of the instrument.
 - c. Set the 5316A rear panel REFERENCE switch to EXT.
 - d. Using a BNC "T" and 50-ohm feedthrough, connect the output of a 3325A Synthesizer/Function Generator to the Channel A Input BNC and to the rear panel External Reference Input.
 - e. Set the 3325A Synthesizer/Function Generator to 10.000000 MHz at 500 mV rms (sine wave).
 - f. Press **FREQ A** on the 5316A front panel. Set the Channel A Trigger Level/Sensitivity switch to **SENS** and set the control fully clockwise.
 - g. Adjust the 5316A **GATE TIME** control until all eight digits of resolution are displayed (about the 12 o'clock position).
 - h. Adjust **A1C45** until the 5316A displays 10.000000 E6 ± 2 counts. Set **A1C45** to the center of the adjustment range in which the 5316A displays the correct count.
 - i. Set the 3325A Synthesizer/Function Generator to 1.000000 MHz at 500 mV rms (sine wave).

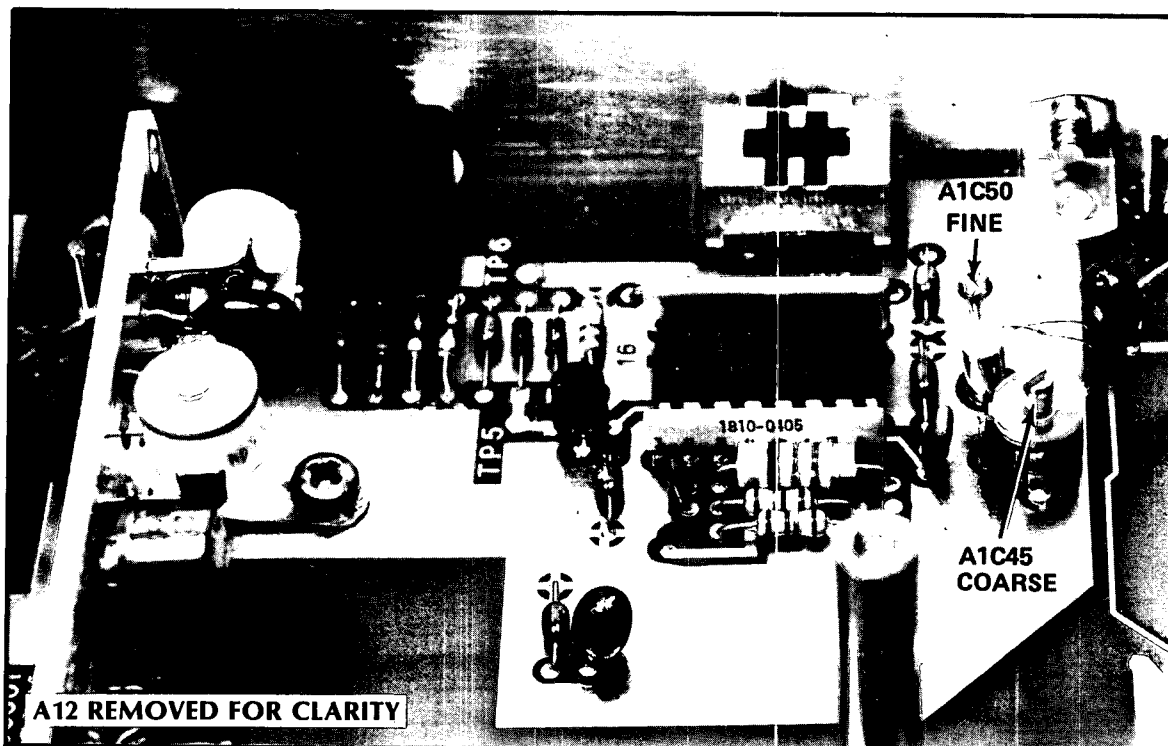

Figure 5-5. Injection-Locked-Multiplier Adjustment Location

- j. The 5316A should display $1.000000\text{ E}6 \pm 2$ counts. If the reading is outside these limits, adjust A1C45 until the display is close to the required value and adjust A1C50 until it is correct. Center A1C50 so that the same amount of adjustment in either direction is possible before the display unlocks from $1.000000\text{ E}6 \pm 2$ counts.

NOTE

If finding the lock-in point is difficult, set the 3325A to 5.000000 MHz at 500 mV rms (sine wave). Adjust A1C45 for a balanced lock-in with a display of $5.000000\text{ E}6 \pm 2$ counts, then repeat for 1.000000 MHz.

- k. Set the 3325A Synthesizer/Function Generator to 1.001400 MHz at 500 mV rms (sine wave). The 5316A should still display $1.000000\text{ E}6 \pm 2$ counts. If the display is outside these limits, carefully adjust A1C50 until the display just locks at $1.000000\text{ E}6 \pm 2$ counts.
- l. Set the 3325A Synthesizer/Function Generator to 0.998600 MHz at 500 mV rms (sine wave). The 5316A should still display $1.000000\text{ E}6 \pm 2$ counts. If the display is outside these limits, carefully adjust A1C50 until the display just locks at $1.000000\text{ E}6 \pm 2$ counts.
- m. Repeat steps d. through j. until the 5316A displays the correct count in all cases.
- n. Set the 3325A Synthesizer/Function Generator to 1.000000 MHz, 5.000000 MHz, and 10.000000 MHz. Verify the 5316A displays the respective frequency and the display remains stable.
- o. This completes the adjustment of the Injection-Locked Multiplier.

5-20. A7 Time Base Reference Adjustment — Standard Instrument

5-21. The following adjustment sets the frequency of the standard internal time base (see Figure 5-6).

- a. Remove the top cover by removing the screw located at the rear of the 5316A. This screw also secures the strap handle. Slide the top cover backward until it can be freely removed.
- b. Press GATE TIME on the 5316A front panel. Adjust the GATE TIME/DELAY control for a gate time of 1 to 2 seconds (not critical).

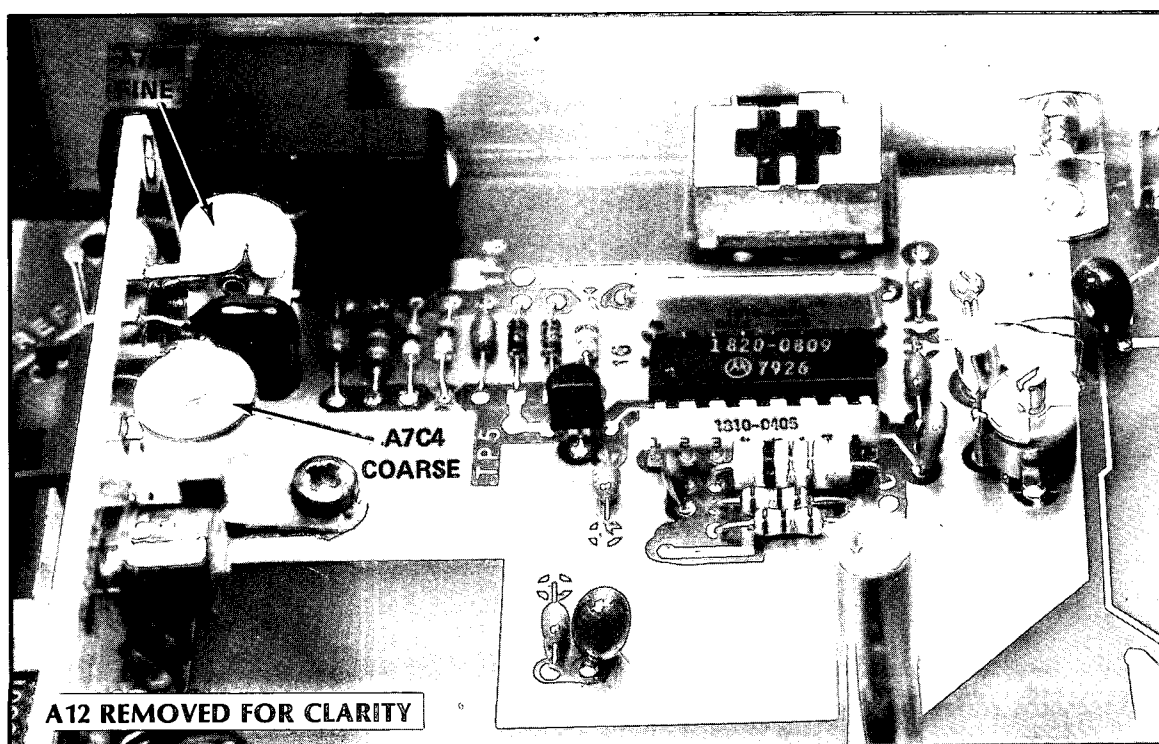

Figure 5-6. Internal Time Base Adjustment Location

- c. Set the 5316A to the FREQ A. Set the Channel A Trigger Level/Sensitivity switch to SENS and set the control fully clockwise.
- d. Set the 3325A Synthesizer/Function Generator to 10.000000 MHz at 100 mV rms. The 3325A should be locked to the house standard, if available.
- e. Connect the output of the 3325A Synthesizer/Function Generator, through a 50-ohm feedthrough to the 5316A Channel A Input BNC.
- f. Adjust A7C7 (fine adjustment) until the 5316A displays 10.000000 E6 \pm 2 counts. If A7C7 does not have enough range for this adjustment, adjust A7C4 (coarse adjustment) until the display is close enough for fine adjustment with A7C7.
- g. This completes the Standard Time Base adjustment.

5-22. A7 Option 001 TCXO Adjustment

5-23. Two procedures are given for the adjustment of Option 001 (TCXO). If the operation of the counter will be solely at 25°C (78°C), then adjust the oscillator frequency as close as possible to 10 MHz using the procedure in paragraph 5-24. If the operation of the counter will be over the full temperature range (0° to 40°C), then the TCXO must be offset by the amount labeled on its cover. This is to keep the TCXO frequency within the manufacturers temperature specifications. In this case, use the procedure in paragraph 5-25. Option 001 TCXO is factory set for use at 25°C.

5-24. Adjustment of Option 001 for use at 25°C.

- a. Remove the top cover by removing the screw located at the rear of the 5316A. This screw also secures the strap handle. Slide the top cover backward until it can be freely removed.
- b. Connect a house standard (reference frequency) to the external SYNC input of a 1740A oscilloscope as shown below. Set the 1740A oscilloscope to External SYNC.

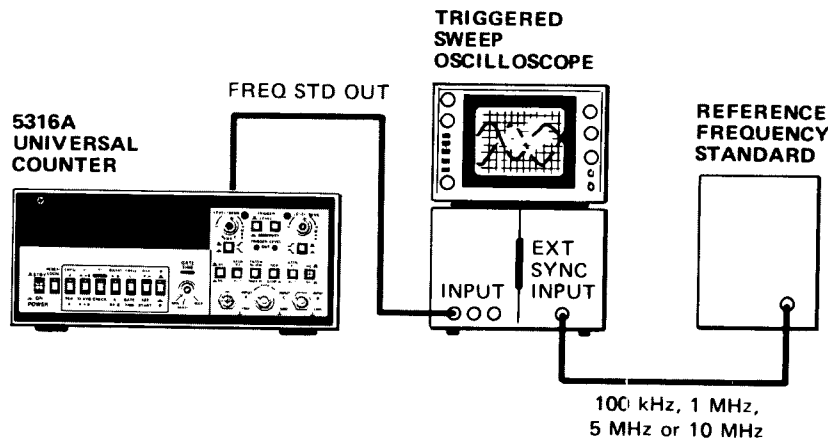

- c. Connect the 5316A rear panel REF IN/OUT to the Channel A input of the 1740A oscilloscope.
- d. Adjust the TCXO frequency for minimum sideways movement of the 10 MHz signal with ADJ on the TCXO. See Figure 5-7.

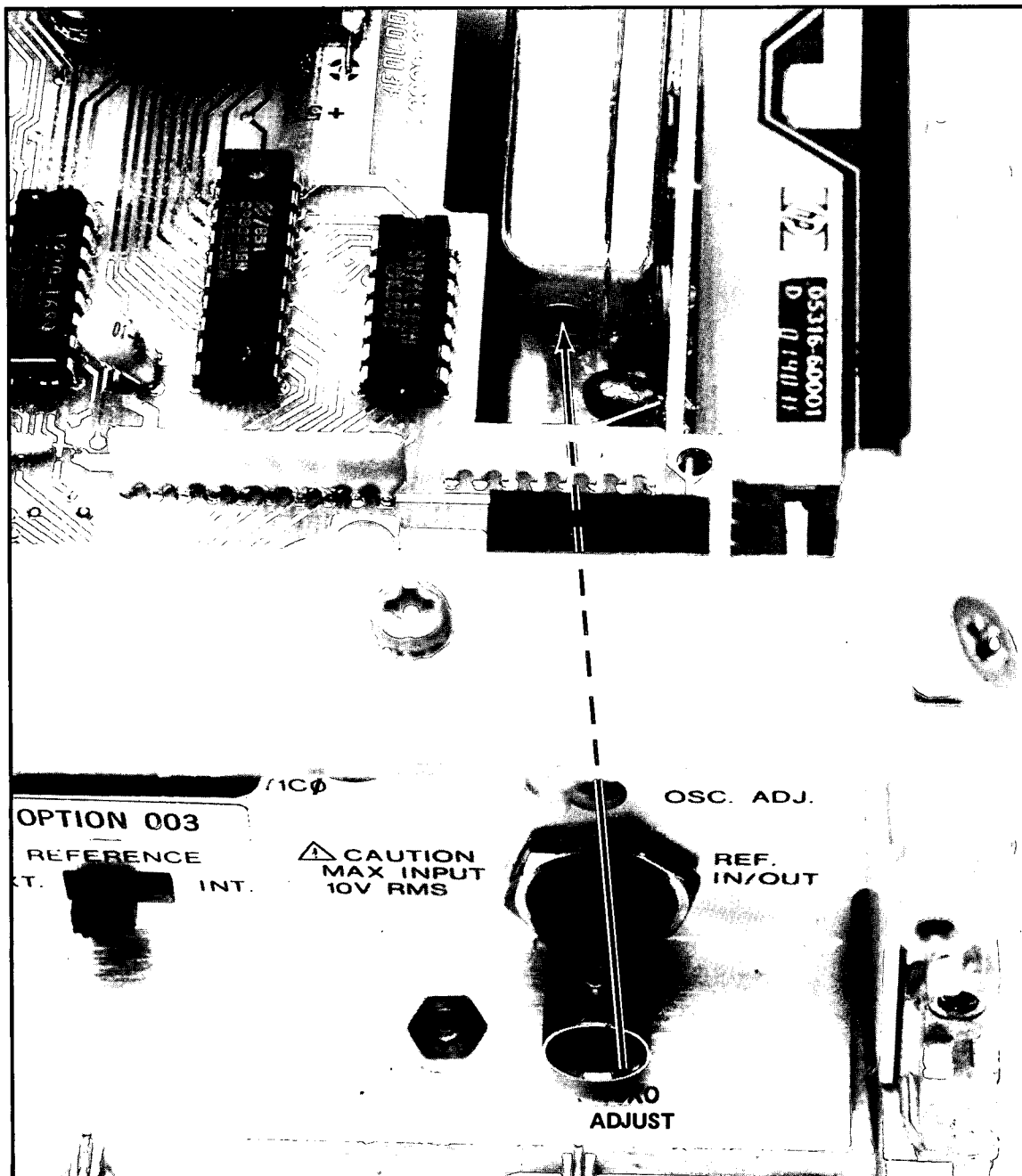

Figure 5-7. TCXO Option 001 Adjustment Location

- e. By timing the sideways movement (in cm/second), the approximate offset can be determined based on the 1740A oscilloscope sweep speed as shown in the following table.
- f. This completes the adjustment of Option 001 TCXO for use at 25°C.

MOVEMENT	SWEEP SPEED			NOTES
	1 μ s/cm	0.1 μ s/cm	0.01 μ s/cm	
1 cm/s	1×10^{-6}	1×10^{-7}	1×10^{-8}	TIME SCOPE TRACE MOVEMENT WITH SECONDHAND OF WATCH OR CLOCK
1 cm/10 s	1×10^{-7}	1×10^{-8}	1×10^{-9}	
1 cm/100 s	1×10^{-8}	1×10^{-9}	1×10^{-10}	

For example, if the trace moves 1 centimeter in 10 seconds and the sweep speed is 0.01 μ s/cm, the oscillator signal is within 1×10^{-9} of the reference frequency.

5-25. Adjustment of Option 001 With Offset (0 to 40°C).

- a. Remove the top cover by removing the screw located at the rear of the 5316A. This screw also secures the strap handle. Slide the top cover backward until it can be freely removed.
- b. Connect a house standard (reference frequency) to the EXT FREQ STD INPUT of a high resolution counter such as an HP 5345A Electronic Counter.
- c. Connect the 5316A rear panel REF IN/OUT to the 5345A Channel A Input BNC.
- d. Set the 5345A to FREQUENCY A, GATE TIME to 1 second, AUTO DISPLAY, and SEP.
- e. Adjust the TCXO frequency to $10 \text{ MHz} \pm$ the offset labeled on the TCXO cover. For example, if the offset is labeled +3.5 Hz, then the TCXO should be adjusted to a frequency of 10.0000035 MHz on the 5345A display at a room temperature of +25°C.

5-26. A7 Option 004 Oven Oscillator

5-27. The following procedure describes the adjustment of the Option 004 (Figure 5-8).

- a. Remove the top cover by removing the screw located at the rear of the 5316A. This screw also secures the strap handle. Slide the top cover backward until it can be freely removed.
- b. Connect the NEGATIVE lead of a 3465A DMM to the 5316A chassis and the PLUS lead to the terminal pin on the A13 module furthest from the left chassis frame. This pin also has a red wire connecting it to the A7 module.
- c. Adjust A7R2 for $+5.00\text{V} \pm 0.01\text{V}$ dc.
- d. The 5316A should now be allowed to operate for at least 30 minutes before proceeding with the oscillator adjustment.

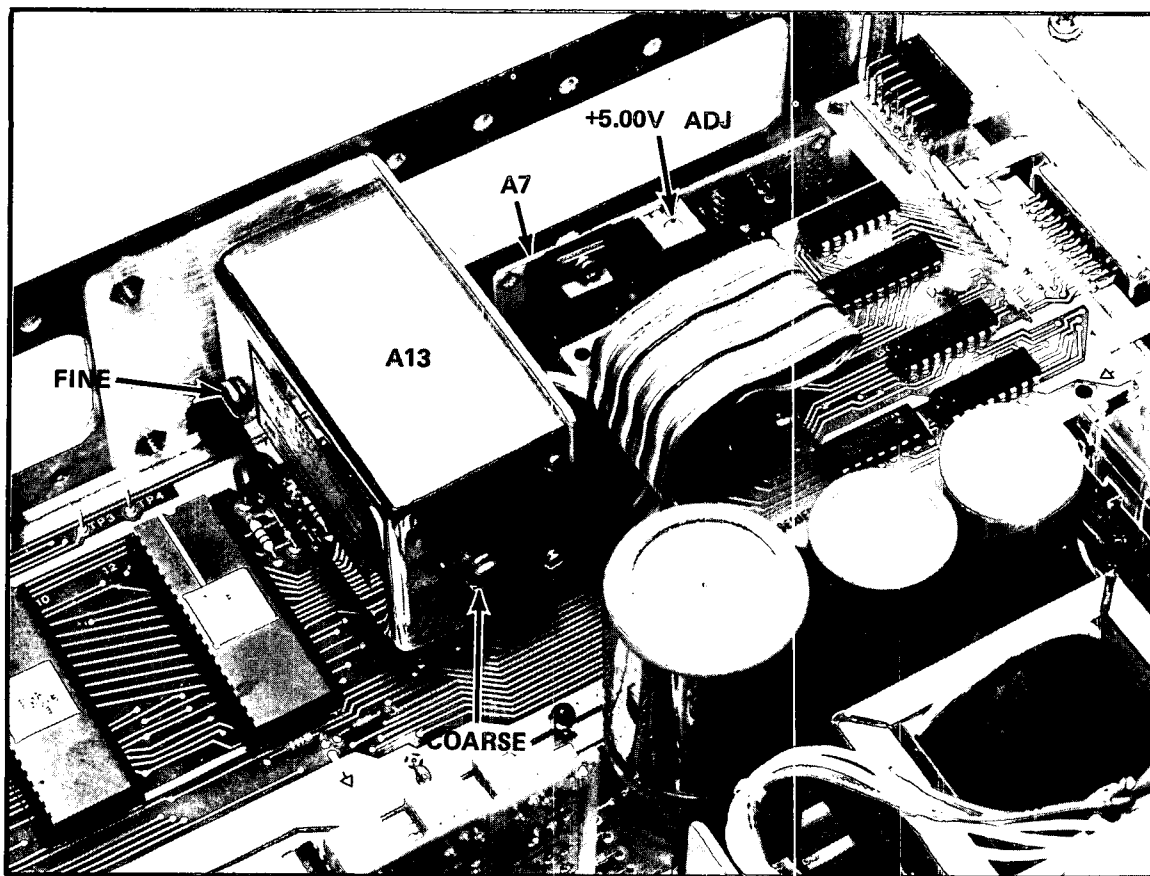

Figure 5-8. Option 004 Oven Oscillator Adjustment Location

- e. Connect the output of an 8660C to the 5316A Channel A input BNC through a 50-ohm feedthrough.
- f. Set the 8660C Synthesizer/Generator to 100.000000 MHz at 100 mV rms. The 8660C must be referenced to a house standard.
- g. Set the 5316A front panel controls to the following:
 - GATE TIME 1 TO 2 SECONDS
 - FUNCTION FREQ A
 - ATTENUATOR X1 (OUT)
 - FILTER NORMAL (OFF)
 - SEP/COM SEPARATE (OUT)
 - TRIGGER LEVEL/SENSITIVITY SENSITIVITY (IN)
 - LEVEL/SENSITIVITY CONTROL FULLY CLOCKWISE
- h. Remove the threaded caps labelled COARSE and FINE from the A13 oscillator module.
- i. Adjust the COARSE control until the 5316A displays 100.000000 MHz ± 1 count. Use the COARSE control to bring the display as close to 100.000000 MHz as possible, then adjust the FINE control for 100.000000 MHz ± 1 count.

NOTE

Overflow LED will turn on; all display digits will show zeros, except the LSB, which shows offset from 10 MHz and should reach 0 ± 1 as FINE control is adjusted.

- j. Replace the adjustment caps and the top cover. The 5316A should continue displaying 100.000000 MHz ± 1 count.

5-28. A9 Option 003 Channel C Adjustment

5-29. The following procedure describes the adjustments required to maintain the Option 003 Channel C operating characteristics within specifications. To access the adjustments of A9 Channel C, the A3/A4 assemblies must be removed as described in the following procedure (see *Figure 5-9*).

- a. Remove the power cord.
- b. Remove the top cover by removing the screw located at the rear of the 5316A. This screw also secures the strap handle. Slide the top cover backward until it can be freely removed.
- c. Remove the top trim strip from the front frame.
- d. Remove the three screws securing the front panel to the front frame at the top.
- e. Remove the two front feet on the bottom of the 5316A.
- f. Remove the three screws securing the front panel to the front frame at the bottom.
- g. Remove the two hex nuts securing the HP-IB connector to the rear panel.
- h. Remove the hex nut securing the REF IN/OUT BNC to the rear panel.
- i. Remove the screw located between the REFERENCE INT/EXT switch and the PRESET GATE TIME control on the rear panel.
- j. Remove the two screws securing the heat sink/support bracket to the right side frame. Remove the screw securing the A6 DAC assembly stand-off to the right side frame.
- k. Disconnect the secondary of transformer T1 from the A1 Motherboard at connector J7 located just in front of the transformer.
- l. Carefully press on the rear of the heat sink and the rear panel BNC and slide the A1 assembly several inches forward through the front frame.

- m. Remove the Trigger Level knobs, the Gate Time knob, the two hex nuts on the Trigger Level controls, and the two hex nuts on the Channel A and B BNC connectors.
- n. Looking at the back of the A2 Display assembly, remove the hex nut located to the right of the assembly (just above the Power STBY/ON switch). Located between the front panel and the A2 Display assembly is a spacer. When the front panel is removed in step p., be sure not to lose the spacer.
- o. The Channel A and B Trigger Level Monitor jacks are secured to the front panel. Two wires with push-on clips connect them to the A3 Input Amplifier assembly. Pull the front panel forward about 1" and, using long-tipped needle-nose pliers, disconnect the two clips from the A3 assembly.
- p. Carefully remove the brass SMC connector from the A9 Input C BNC assembly. Remove the front panel. Note the space between the front panel and the A2 assembly.

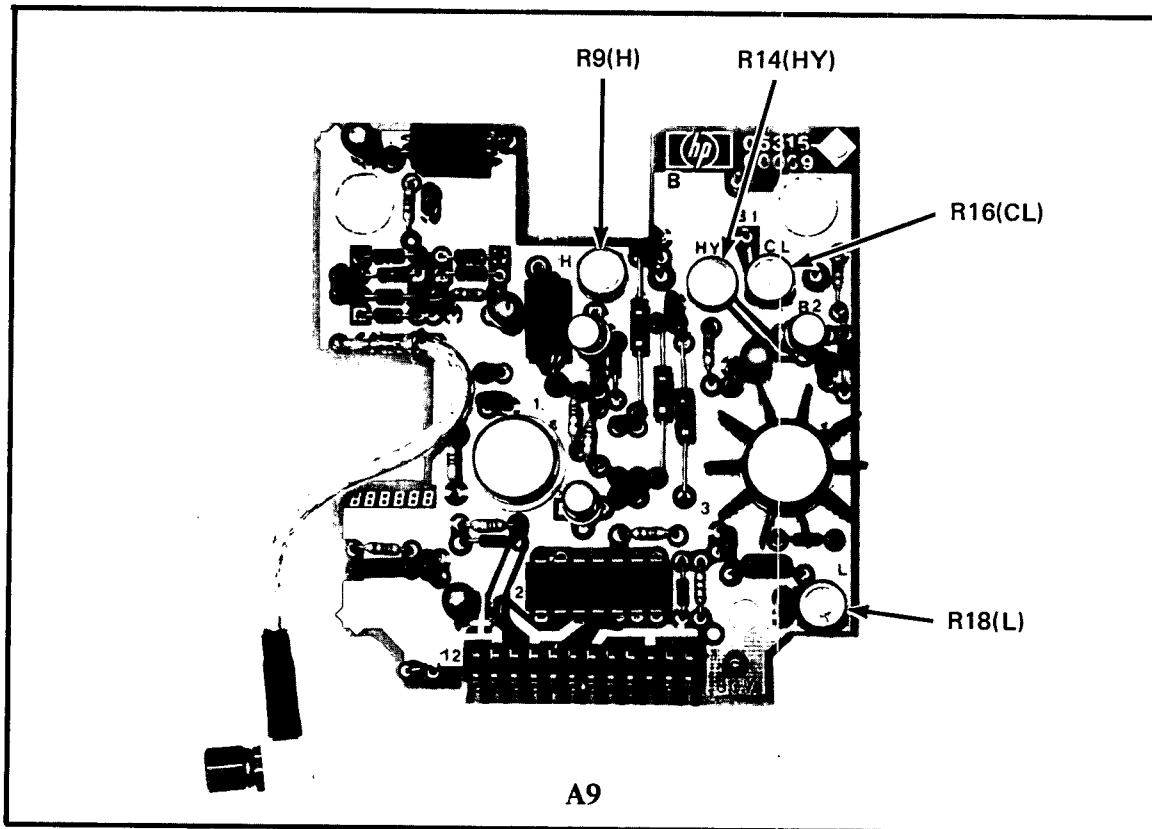

Figure 5-9. Channel C Adjustment Location

- q. Remove the four screws securing the A3/A4 assembly. Remove the A4 assembly by gently lifting on the rear edge of A4, until the pins come free of the A1 Motherboard connector A1J5.
- r. Slide the 5316A back into the chassis and reconnect the secondary of transformer T1 to A1J7 located just in front of the transformer.
- s. Reconnect the brass SMC connector to the Input C BNC assembly and loosely replace the front panel.
- t. Reconnect the power cord to the rear panel.
- u. Connect a jumper wire between the Test Points labelled SCV and TP+5.
- v. Connect an HP 8660C Synthesized Signal Generator to the Input C BNC.
- w. Set the 8660C to 10.000 MHz at 500 mV rms.

NOTE

The 3465A DMM to be used in the following step MUST have floating inputs.

- x. Using a suitable IC clip, connect a 3465A DMM between A9U2 pin 8 and ground. Adjust trimmer "L" (A9R18) for a reading of $2.6V \pm 5 \text{ mV}$ on the 3465A DMM.
- y. Reduce the 8660C output level to $500 \mu\text{V}$ (.5 mV) rms. Connect the 3465A DMM positive lead to TP"B1" and the common lead to TP"B2". Adjust trimmer "HY" (A9R14) for a reading of $110 \text{ mV} \pm 1 \text{ mV}$ on the 3465A DMM.
- z. Increase the 8660C output level to 50 mV rms. Adjust trimmer labeled "H" (A9R9) for a reading of $75 \text{ mV} \pm 1 \text{ mV}$ (differential between TPB1 and TPB2) on the 3465A DMM.
- aa. Connect the 3465A DMM positive lead to TP"C". Adjust trimmer "CL" (A9R16) for a reading of $37 \text{ mV} +1/-0 \text{ mV}$.
- bb. Connect the 8660C rear panel REFERENCE OUT to the 5316A rear panel REF IN. Set the 5316A rear panel REFERENCE EXT/INT to the EXT position.
- cc. Verify the 5316A displays $100.0000 \text{ MHz} \pm 1 \text{ count}$. If a generator other than the 8660C is used and/or no reference out is available, then the display should be $100.0000 \text{ MHz} \pm \text{time base error} \pm 1 \text{ count}$.
- dd. Recheck steps y. through bb. to verify all voltages. Repeat these steps until all voltages are within tolerance.
- ee. Vary the 8660C frequency from 50 MHz to 650 MHz at 15 mV rms, and 650 MHz to 1000 MHz at 75 mV and verify the 5316A displays the proper frequency.
- ff. Reassemble the 5316A by performing steps a. through r. in reverse order.
- gg. This completes the A9 Channel C adjustments.

SECTION VI REPLACEABLE PARTS

6-1. INTRODUCTION

6-2. This section contains information for ordering replacement parts. *Table 6-1* lists the abbreviations used in the parts list and throughout this manual. *Table 6-2* lists all of the replaceable parts for the 5316A including the options. The parts list is set-up in order of the assembly reference designators (A1, A2, A3, etc.). The three options, Option 001, 003, and 004 are listed in order with the other assemblies. *Table 6-3* lists the mechanical parts (chassis parts, front panel, etc). *Table 6-4* lists the hardware used throughout the 5316A. *Table 6-5* contains the names and addresses that correspond with the manufacturer's code numbers.

6-3. ABBREVIATIONS

6-4. *Table 6-1* lists the abbreviations used in the parts list, schematics, and throughout the manual. In some cases, two forms of the abbreviations may appear, one in all capital letters, and one in partial or no capital letters. This occurs because the abbreviations in the parts lists are always capitals. However, in the schematics and other parts of the manual, other abbreviation forms are used with lower case and upper case letters.

6-5. REPLACEABLE PARTS

6-6. *Tables 6-2* and *6-3* are the lists of replaceable parts and are organized as follows:

- a. Electrical assemblies and their components in alphanumerical order by reference designation.
- b. Chassis-mounted parts in alphanumerical order by reference designation.
- c. Miscellaneous parts.

6-7. The information given for each part consists of the following:

- a. The Hewlett-Packard part number.
- b. The part number check digit (CD).
- c. The total quantity (Qty) used in the assembly.
- d. The description of the part.
- e. A typical manufacturer of the part in a five-digit code.
- f. The manufacturers number for the part.

6-8. The total quantity of each part used within each assembly is given only once at the first appearance of the part number in the lists.

6-9. ORDERING INFORMATION

6-10. To order a part listed from the replaceable parts table, quote the Hewlett-Packard part number, indicate the quantity required, and address the order to the nearest Hewlett-Packard Office.

6-11. To order a part that is not listed in the replaceable parts table, include the model number, serial number, the description and function of the part, and the number of parts required. Address the order to the nearest Hewlett-Packard Office.

Table 6-1. Reference Designations and Abbreviations

REFERENCE DESIGNATIONS

A = assembly	DL = delay line	K = relay	T = transformer
AT = attenuator; isolator; termination	DS = annunciator; signaling device (audible or visual); lamp; LED	L = coil; inductor	TB = terminal board
B = fan; motor	E = miscellaneous electrical part	M = metre	TC = thermocouple
BT = battery	F = fuse	MP = miscellaneous mechanical part	TP = test point
C = capacitor	FL = filter	P = electrical connector (movable portion); plug	U = integrated circuit; microcircuit
CP = coupler	H = hardware	Q = transistor; SCR; triode thyristor	V = electron tube
CR = diode; diode thyristor; varactor	HY = circulator	R = resistor	VR = voltage regulator; breakdown diode
DC = directional coupler	J = electrical connector (stationary portion); jack	RT = thermistor	W = cable; transmission path; wire
		S = switch	X = socket
			Y = crystal unit-piezo-electric
			Z = tuned cavity; tuned circuit

ABBREVIATIONS

A = ampere	HD = head	NE = neon	SPST = single-pole, single-throw
ac = alternating current	HDW = hardware	NEG = negative	SSB = single sideband
ACCESS = accessory	HF = high frequency	nF = nanofarad	SST = stainless steel
ADJ = adjustment	HG = mercury	NI PL = nickel plate	STL = steel
A/D = analog-to-digital	HI = high	N/O = normally open	SQ = square
AF = audio frequency	HP = Hewlett-Packard	NOM = nominal	SWR = standing-wave ratio
AFC = automatic frequency control	HPF = high pass filter	NORM = normal	SYNC = synchronize
AGC = automatic gain control	HR = hour (used in parts list)	NPN = negative-positive-negative	T = timed (slow-blow fuse)
AL = aluminum	HV = high voltage	NPO = negative-positive zero (zero temperature coefficient)	TA = tantalum
ALC = automatic level control	Hz = hertz	NRFR = not recommended for field replacement	TC = temperature compensating
AM = amplitude modulation	IC = integrated circuit		TD = time delay
AMPL = amplifier	ID = inside diameter	ns = nanosecond	TERM = terminal
APC = automatic phase control	IF = intermediate frequency	NSR = not separately replaceable	TFT = thin-film transistor
ASSY = assembly	IMPG = impregnated	nW = nanowatt	TGL = toggle
AUX = auxiliary	in = inch	OBD = order by description	THD = thread
AVG = average	INCD = incandescent	OD = outside diameter	THRU = through
AWG = american wire gauge	INCL = include(s)	OH = oval head	TI = titanium
BAL = balance	INP = input	OP AMPL = operational amplifier	TOL = tolerance
BCD = binary coded decimal	INS = insulation	OPT = option	TRIM = trimmer
BD = board	INT = internal	OSC = oscillator	TSTR = transistor
BE CU = beryllium copper	kg = kilogram	OX = oxide	TTL = transistor-transistor logic
BFO = beat frequency oscillator	kHz = kilohertz	oz = ounce	TV = television
BH = binder head	kΩ = kilohm	Ω = ohm	TVI = television interference
BKDN = breakdown	kV = kilovolt	P = peak (used in parts list)	TWT = traveling wave tube
BP = bandpass	lb = pound	PAM = pulse-amplitude modulation	U = micro (10 ⁻⁶) used in parts list
BPF = bandpass filter	LC = inductance-capacitance	PC = printed circuit	UF = microfarad (used in parts list)
BRS = brass	LED = light-emitting diode	PCM = pulse-code modulation; pulse-count modulation	UHF = ultrahigh frequency
BWO = backward-wave oscillator	LF = low frequency	PDM = pulse-duration modulation	UNREG = unregulated
CAL = calibrate	LG = long	pF = picofarad	V = volt
ccw = counterclockwise	LH = left hand	PH BRZ = phosphor bronze	VA = voltampere
CER = ceramic	LIM = limit	PHL = phillips	Vac = volts ac
CHAN = channel	LIN = linear	PIN = positive-intrinsic-negative	VAR = variable
cm = centimeter	LK WASH = lockwasher	PIV = peak inverse voltage	VCO = voltage-controlled oscillator
CMO = coaxial	LOG = logarithmic taper (used in parts list)	pk = peak	Vdc = volts dc
COEF = coefficient	log = logarithmic	PL = phase lock	VDCW = volts, dc, working (used in parts list)
COMP = common	LPF = low pass filter	PLO = phase lock oscillator	V(F) = volts, filtered
COMPL = composition	LV = low voltage	PM = phase modulation	VFO = variable-frequency oscillator
CONN = connector	m = metre (distance)	PNP = positive-negative-positive	VHF = very-high frequency
CP = cadmium plate	mA = milliampere	P/O = part of	Vpk = volts peak
CRT = cathode-ray tube	MAX = maximum	POLY = polystyrene	Vp-p = volts peak-to-peak
CTL = complementary transistor logic	MEG = megohm	PORC = porcelain	Vrms = volts rms
cw = continuous wave	MEG (10 ⁶) = meg (used in parts list)	POS = positive; position(s) (used in parts list)	VSWR = voltage standing wave ratio
cw = clockwise	MET FLM = metal film	POSN = position	VTO = voltage-tuned oscillator
D/A = digital-to-analog	MET OX = metal oxide	POT = potentiometer	VTVM = vacuum-tube voltmeter
dB = decibel	MF = medium frequency; microfarad (used in parts list)	p-p = peak-to-peak	V(X) = volts, switched
dBm = decibel referred to 1 mW	MFR = manufacturer	PP = peak-to-peak (used in parts list)	W = watt
dc = direct current	mg = milligram	PPM = pulse-position modulation	W/ = with
deg = degree (temperature interval or difference)	MHz = megahertz	PREAMPL = preamplifier	WIV = working inverse voltage
° = degree (plane angle)	mH = millihenry	PRF = pulse-repetition frequency	WW = wirewound
°C = degree Celsius (centigrade)	mho = conductance	PRR = pulse repetition rate	W/O = without
°F = degree Fahrenheit	MIN = minimum	ps = picosecond	YIG = yttrium-iron-garnet
°K = degree Kelvin	min = minute (time)	PT = point	Zo = characteristic impedance
DEPC = deposited carbon	MINAT = minute (plane angle)	PTM = pulse-time modulation	
DET = detector	mm = millimetre	PWM = pulse-width modulation	
diam = diameter	MOD = modulator	PWV = peak working voltage	
DIA = diameter (used in parts list)	MOM = momentary	RC = resistance capacitance	
DIFF AMPL = differential amplifier	MOS = metal-oxide semiconductor	RECT = rectifier	
div = division	ms = millisecond	REF = reference	
DPDT = double-pole, double-throw	MTG = mounting	REG = regulated	
DR = drive	MTR = meter (indicating device)	REPL = replaceable	
DSB = double sideband	mV = millivolt	RF = radio frequency	
DTL = diode transistor logic	mV ac = millivolt, ac	RFI = radio frequency interference	
DVM = digital voltmeter	mV dc = millivolt, dc	RH = round head; right hand	
ECL = emitter coupled logic	mVpk = millivolt, peak	RLC = resistance-inductance-capacitance	
EMF = electromotive force	mVp-p = millivolt, peak-to-peak	RMO = rack mount only	
EDP = electronic data processing	mVrms = millivolt, rms	rms = root-mean-square	
ELECT = electrolytic	mW = milliwatt	RND = round	
ENCAP = encapsulated	MUX = multiplex	ROM = read-only memory	
EXT = external	MY = mylar	R&P = rack and panel	
F = farad	μA = microampere	RWW = reverse working voltage	
FET = field-effect transistor	μF = microfarad	S = scattering parameter	
F/F = flip-flop	μH = microhenry	S = second (time)	
FH = flat head	μH = microhenry	S " = second (plane angle)	
FOL H = fillister head	μmho = microhmho	S-B = slow-blow fuse (used in parts list)	
FM = frequency modulation	μS = microsecond	SCR = silicon controlled rectifier; screw	
FP = front panel	μV = microvolt	SE = selenium	
FREQ = frequency	μV ac = microvolt, ac	SECT = sections	
FXD = fixed	μV dc = microvolt, dc	SEMICON = semiconductor	
g = gram	μVpk = microvolt, peak	SHF = superhigh frequency	
GE = germanium	μVp-p = microvolt, peak-to-peak	SI = silicon	
GHz = gigahertz	μVrms = microvolt, rms	SL = slide	
GL = glass	nA = nanoampere	SNR = signal-to-noise ratio	
GND = ground(ed)	NC = no connection	SPDT = single-pole, double-throw	
H = henry	N/C = normally closed	SPG = spring	
h = hour		SR = split ring	
HET = heterodyne			
HEX = hexagonal			

NOTE

All abbreviations in the parts list will be in upper case.

MULTIPLIERS

Abbreviation	Prefix	Multiple
T	tera	10 ¹²
G	giga	10 ⁹
M	mega	10 ⁶
k	kilo	10 ³
da	deka	10
d	deci	10 ⁻¹
c	centi	10 ⁻²
m	milli	10 ⁻³
μ	micro	10 ⁻⁶
n	nano	10 ⁻⁹
p	pico	10 ⁻¹²
f	femto	10 ⁻¹⁵
a	atto	10 ⁻¹⁸

6-12. DIRECT MAIL ORDER SYSTEM

6-13. Within the USA, Hewlett-Packard can supply parts through a direct mail order system. The advantages of using this system are:

- a. Direct ordering and shipment from the HP Parts Center in Mountain View, California.
- b. No maximum or minimum on any mail order (there is a minimum order amount for parts ordered through a local HP office when the order requires billing and invoicing).
- c. Prepaid transportation (there is a small handling charge for each order).
- d. No invoicing to provide these advantages, a check or money order must accompany each order.

6-14. Mail order forms and specific ordering information is available through your local HP office. Addresses and phone numbers are located at the back of this manual.

6-15. SPECIAL PARTS REPLACEMENT CONSIDERATIONS

6-16. Certain mechanical parts and electrical components required special considerations. They are:

- a. Transformer T1: If the power transformer T1 must be replaced, order HP Part Number 05316-80001. This is a complete transformer assembly including the connectors. The parts list for T1 contains all of the miscellaneous parts that make-up the assembly for those cases where only a connector is defective and not the transformer itself. The transformer support bracket (MP29) is not included.
- b. Front Panel: Two front panels are available. The standard front panel without a hole for the Channel C BNC connector, HP Part Number 05316-00001. The front panel with the hole for the Channel C BNC is HP Part Number 05316-00005. The replacement front panel includes the two trigger level test points (labelled TRIGGER LEVEL OUT). However, the replacement front panels do not include the wires that connect the trigger level test points to the A3 assembly or any of the switch bezels, knobs, or display window.
- c. Side Struts: The left- and right-side struts are physically different and cannot be interchanged. The left strut is drilled to facilitate the addition of Option 006 Offset/Normalizer. Looking from the front of the instrument, the right-side strut (undrilled) is HP Part Number 5020-8831, and the left-side strut (drilled) is HP Part Number 5020-8886.
- d. Function Switch Assembly S1: The function switches are one complete assembly. If any one section is found to be defective the complete block of switches must be replaced. Care should be taken when removing the switch assembly to avoid damage to the A1 Motherboard. The switch assembly is HP Part Number 3101-2297.
- e. Input Amplifier Assembly A3/A4: If either the Input Switch assembly A3, or the Input Amplifier assembly A4 is to be replaced, both must be replaced as one complete assembly by ordering HP Part Number 05316-60100. Do not attempt to separate the assemblies and replace only one.
- f. Of the five LSI IC's used in the 5316A, only two are available from suppliers other than HP. They are the Motorola MC68488, A1U12, and the Display Driver, Intersil ICM7218A, A2U2. The two Microcomputers, A1U1, a Mostek/Motorola 3870 and A1U10, a Motorola MC6801, contain internal ROM that is programmed specifically for the 5316A and are available only from HP. The Multiple-Register-Counter (MRC) A1U2 is manufactured only by HP and is not available from any other suppliers.
- g. A1 Motherboard: If the A1 Motherboard is to be replaced, order HP Part Number 05316-60001. This will include the four LSI IC's, A1U1, U2, U10, and U12. Also included are the heatsink support bracket (MP28) and the A5 Display Support assembly.

Model 5316A
 Replaceable Parts

- h. Bottom Cover MP9: The replacement bottom cover (HP Part Number 5060-9964) does not include the information label MP18. The label must be ordered separately under HP Part Number 7120-8571.
- i. A1 Motherboard Slide Rails: If any of the A1 Motherboard slide rails (MP19) are to be replaced, new retainers (MP20) should be used. Two are required for each rail.
- j. REF IN/OUT BNC connector (J9): The REF IN/OUT BNC connector is secured to the A1 Motherboard with two rivets. If the connector is to be replaced, the following procedure should be used to replace the connector.
 1. Remove the A1 Motherboard as described in Section V, A9 Option 003 Channel C Adjustment, paragraph 5-26, steps a. through l. Also remove the A6 Digital-to-Analog Converter assembly. Remove the A1 Motherboard completely from the chassis.
 2. Obtain the following hardware:

ITEM	DESCRIPTION	QUANTITY	HP PART NO.
1	4-40 × 1/2" Screw with Lockwasher	2	2200-0111
2	4-40 Elastic Stop Nut	2	2260-0003
3	#4 Flat Washer	2	3050-0105

3. Using a 1/8" drill bit, drill out the two rivets and unsolder the two leads at the motherboard.
4. Secure the new connector to the A1 Motherboard as shown in the following figure.

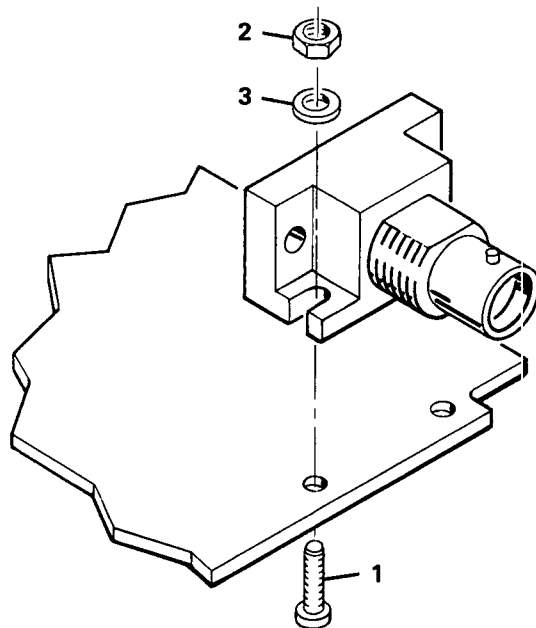

Table 6-2. Replaceable Parts

Reference Designation	HP Part Number	C D	Qty	Description	Mfr Code	Mfr Part Number
A1	05316-60001		4	MOTHERBOARD (SERIES 2120A)	28480	05316-60001
A1C1	0160-4557	0	2	CAPACITOR-FXD .1UF +-20% 50VDC CER	16299	CAC04X7R104M050A
A1C2	0160-3879	7	6	CAPACITOR-FXD .01UF +-20% 100VDC CER	28480	0160-3879
A1C3	0180-0562	1	9	CAPACITOR-FXD 33UF+-20% 10VDC TA	56289	196D336X0010KA1
A1C4	0160-3879	7		CAPACITOR-FXD .01UF +-20% 100VDC CER	28480	0160-3879
A1C5	0160-4556	9	1	CAPACITOR-FXD 1000PF +-20% 100VDC CER	16299	CAC02X7R102M100A
A1C6	0160-3879	7		CAPACITOR-FXD .01UF +-20% 100VDC CER	28480	0160-3879
A1C7	0160-3879	7		CAPACITOR-FXD .01UF +-20% 100VDC CER	28480	0160-3879
A1C8	0160-3879	7		CAPACITOR-FXD .01UF +-20% 100VDC CER	28480	0160-3879
A1C9	0160-3879	7		CAPACITOR-FXD .01UF +-20% 100VDC CER	28480	0160-3879
A1C10	0160-4554	7	15	CAPACITOR-FXD .01UF +-20% 50VDC CER	28480	0160-4554
A1C11	0160-4557	0		CAPACITOR-FXD .1UF +-20% 50VDC CER	16299	CAC04X7R104M050A
A1C12	0180-0562	1		CAPACITOR-FXD 33UF+-20% 10VDC TA	56289	196D336X0010KA1
A1C13	0180-0562	1		CAPACITOR-FXD 33UF+-20% 10VDC TA	56289	196D336X0010KA1
A1C14	0160-4554	7		CAPACITOR-FXD .01UF +-20% 50VDC CER	28480	0160-4554
A1C15	0180-2815	1	3	CAPACITOR-FXD 100UF+-20% 10VDC TA	28480	0180-2815
A1C16	0180-2815	1		CAPACITOR-FXD 100UF+-20% 10VDC TA	28480	0180-2815
A1C17	0160-4554	7		CAPACITOR-FXD .01UF +-20% 50VDC CER	28480	0160-4554
A1C18	0180-2820	8	3	CAPACITOR-FXD .22UF+-20% 35VDC TA	28480	0180-2820
A1C19	0180-2820	8		CAPACITOR-FXD .22UF+-20% 35VDC TA	28480	0180-2820
A1C20	0160-4554	7		CAPACITOR-FXD .01UF +-20% 50VDC CER	28480	0160-4554
A1C21				NOT ASSIGNED		
A1C22	0160-4554	7		CAPACITOR-FXD .01UF +-20% 50VDC CER	28480	0160-4554
A1C23	0160-4493	3	2	CAPACITOR-FXD 27PF +-5% 200VDC CER 0+-30	51642	200-200-NP0-270J
A1C24	0160-4493	3		CAPACITOR-FXD 27PF +-5% 200VDC CER 0+-30	51642	200-200-NP0-270J
A1C25	0180-0562	1		CAPACITOR-FXD 33UF+-20% 10VDC TA	56289	196D336X0010KA1
A1C26	0180-2815	1		CAPACITOR-FXD 100UF+-20% 10VDC TA	28480	0180-2815
A1C27				NOT ASSIGNED		
A1C28	0180-0562	1		CAPACITOR-FXD 33UF+-20% 10VDC TA	56289	196D336X0010KA1
A1C29	0160-4389	6	3	CAPACITOR-FXD 100PF +-5PF 200VDC CER	51642	200-200-NP0-101J
A1C30	0160-4389	6		CAPACITOR-FXD 100PF +-5PF 200VDC CER	51642	200-200-NP0-101J
A1C31	0160-4389	6		CAPACITOR-FXD 100PF +-5PF 200VDC CER	51642	200-200-NP0-101J
A1C32	0180-0562	1		CAPACITOR-FXD 33UF+-20% 10VDC TA	56289	196D336X0010KA1
A1C33	0160-4554	7		CAPACITOR-FXD .01UF +-20% 50VDC CER	28480	0160-4554
A1C34	0180-2820	8		CAPACITOR-FXD .22UF+-20% 35VDC TA	28480	0180-2820
A1C35	0180-0562	1		CAPACITOR-FXD 33UF+-20% 10VDC TA	56289	196D336X0010KA1
A1C36	0160-4554	7		CAPACITOR-FXD .01UF +-20% 50VDC CER	28480	0160-4554
A1C37	0180-2990	3	1	CAPACITOR-FXD 7500UF+75-10% 20VDC AL	28480	0180-2990
A1C38	0180-2991	4	2	CAPACITOR-FXD 3900UF+100-10% 20VDC AL	56289	674D398H020JL5A
A1C39	0180-2991	4		CAPACITOR-FXD 3900UF+100-10% 20VDC AL	56289	674D398H020JL5A
A1C40	0180-0562	1		CAPACITOR-FXD 33UF+-20% 10VDC TA	56289	196D336X0010KA1
A1C41	0160-4554	7		CAPACITOR-FXD .01UF +-20% 50VDC CER	28480	0160-4554
A1C42	0160-4554	7		CAPACITOR-FXD .01UF +-20% 50VDC CER	28480	0160-4554
A1C43	0160-4386	3	1	CAPACITOR-FXD 33PF +-5% 200VDC CER 0+-30	51642	200-200-NP0-330J
A1C44				NOT ASSIGNED		
A1C45	0121-0475	1	1	CAPACITOR-V TRMR-POLYP 2-22PF 100V	D2540	2222 808 11229
A1C46				NOT ASSIGNED		
A1C47	0160-4554	7		CAPACITOR-FXD .01UF +-20% 50VDC CER	28480	0160-4554
A1C48	0160-4554	7		CAPACITOR-FXD .01UF +-20% 50VDC CER	28480	0160-4554
A1C49	0160-4554	7		CAPACITOR-FXD .01UF +-20% 50VDC CER	28480	0160-4554
A1C50	0121-0168	9	1	CAPACITOR-V TRMR-PSTN .2-1.5PF 600V	28480	0121-0168
A1C51	0180-0562	1		CAPACITOR-FXD 33UF+-20% 10VDC TA	56289	196D336X0010KA1
A1C52	0160-4554	7		CAPACITOR-FXD .01UF +-20% 50VDC CER	28480	0160-4554
A1C53	0160-4554	7		CAPACITOR-FXD .01UF +-20% 50VDC CER	28480	0160-4554
A1C54	0160-4481	9	1	CAPACITOR-FXD 270PF +-5% 100VDC CER	51642	150-100-NP0-271J
A1CR1	1901-0040	1	6	DIODE-SWITCHING 30V 50MA 2NS DO-35	28480	1901-0040
A1CR2	1901-0040	1		DIODE-SWITCHING 30V 50MA 2NS DO-35	28480	1901-0040
A1CR3	1901-0518	3		DIODE-SM SIG SCOTTKY	28480	1901-0518
A1CR4	1901-0731	7	3	DIODE-PWR RECT 400V 1A	28480	1901-0731
A1CR5	1902-0049	2	1	DIODE-ZNR 6.19V 5% DO-35 PD=.4W	28480	1902-0049
A1CR6	1901-0040	1		DIODE-SWITCHING 30V 50MA 2NS DO-35	28480	1901-0040
A1CR7	1901-0638	3	1	DIODE-FW BRDG 100V 4A	04713	KDA-970-2
A1CR8	1901-0731	7		DIODE-PWR RECT 400V 1A	28480	1901-0731
A1CR9	1901-0731	7		DIODE-PWR RECT 400V 1A	28480	1901-0731
A1CR10	1901-0040	1		DIODE-SWITCHING 30V 50MA 2NS DO-35	28480	1901-0040
A1CR11	1901-0040	1		DIODE-SWITCHING 30V 50MA 2NS DO-35	28480	1901-0040
A1CR12	1901-0518	8	1	DIODE-SM SIG SCHOTTKY	28480	1901-0518
A1CR13	1901-0518	8		DIODE-SM SIG SCHOTTKY	28480	1901-0518
A1CR14	1901-0040	8		DIODE-SWITCHING 30V 50MA 2NS DO-35	28480	1901-0040
A1J1	1200-0423	8		SOCKET-IC 16-CONT DIP DIP-SLDR	28480	1200-0423
A1J2	1251-3768	7	1	CONTACT-CONN U/W-POST-TYPE MALE DPSLDR	28480	1251-3768
A1J3	1251-5237	9	1	CONNECTOR 11-PIN M POST TYPE	28480	1251-5237
A1J4	1251-5281	3	1	CONNECTOR 12-PIN F POST TYPE	28480	1251-5281
A1J5	1200-0423	8	2	SOCKET-IC 16-CONT DIP DIP-SLDR	28480	1200-0423
A1J5P1	1251-4787	2	1	SHUNT-DIP 8-POSITION (TEST JUMPER)	28480	1251-4787

See introduction to this section for ordering information
*Indicates factory selected value

Table 6-2. Replaceable Parts (Continued)

Reference Designation	HP Part Number	C D	Qty	Description	Mfr Code	Mfr Part Number
A1J6	1251-1626	2	1	CONNECTOR-PC EDGE 12-CONT/ROW 2-RDWS	28480	1251-1626
A1J7	1251-3638	0	1	CONNECTOR 6-PIN M POST TYPE	28480	1251-3638
A1J8	1200-0567	1	1	SOCKET-IC 28-CONT DIP DIP-SLDR	28480	1200-0567
A1J9	1250-1630	6	1	CONNECTOR-RF BNC FEM SGL-HOLE-RR 50-OHM	28480	1250-1630
A1J10	1251-4215	1	1	CONNECTOR 6-PIN F POST TYPE	28480	1251-4215
A1K1	0490-0617	4	1	RELAY-REED 1C 250MA 28VDC 5VDC-COIL	28480	0490-0617
A1L1	9100-1637	4	2	INDUCTOR RF-CH-MLD 120UH 5% .166DX.385LG	28480	9100-1637
A1L2	9140-0114	4	1	INDUCTOR RF-CH-MLD 10UH 10% .166DX.385LG	28480	9140-0114
A1L3	9100-1637	4	1	INDUCTOR RF-CH-MLD 120UH 5% .166DX.385LG	28480	9100-1637
A1Q1	1853-0036	2	2	TRANSISTOR PNP SI PD=310MW FT=250MHZ	28480	1853-0036
A1Q2	1854-0215	1	5	TRANSISTOR NPN SI PD=350MW FT=300MHZ	04713	2N3904
A1Q3	1854-0215	1	1	TRANSISTOR NPN SI PD=350MW FT=300MHZ	04713	2N3904
A1Q4	1853-0363	8	2	TRANSISTOR PNP SI PD=50W FT=20MHZ	03508	X45H281
	0340-0864	6	3	INSULATOR-XSTR THRM-CNDCT	28480	0340-0864
	3050-0791	6	3	INSULATOR-XSTR NYLON	28480	3050-0791
A1Q5	1854-0215	1	1	TRANSISTOR NPN SI PD=350MW FT=300MHZ	04713	2N3904
A1Q6	1854-0215	1	1	TRANSISTOR NPN SI PD=350MW FT=300MHZ	04713	2N3904
A1Q7	1853-0363	8	1	TRANSISTOR PNP SI PD=50W FT=20MHZ	03508	X45H281
	0340-0864	6	1	INSULATOR-XSTR THRM-CNDCT	28480	0340-0864
	3050-0791	6	1	INSULATOR-XSTR NYLON	28480	3050-0791
A1Q8	1853-0036	2	1	TRANSISTOR PNP SI PD=310MW FT=250MHZ	28480	1853-0036
A1Q9	1854-0560	9	1	TRANSISTOR NPN SI DARL PD=310MW	04713	MPS A12
A1Q10	1854-0635	9	1	TRANSISTOR NPN SI PD=50W FT=20MHZ	03508	D44H5
	0340-0864	6	1	INSULATOR-XSTR THRM-CNDCT	28480	0340-0864
	3050-0791	6	1	INSULATOR-XSTR NYLON	28480	3050-0791
A1Q11	1854-0215	1	1	TRANSISTOR NPN SI PD=350MW FT=300MHZ	04713	2N3904
A1R1	2100-3719	0	1	RESISTOR-VARIABLE W/SW 470K OHM +-20%	28480	2100-3719
A1R2	1810-0365	0	1	NETWORK-RES 6-SIP2.2K OHM X 5	01121	206A222
A1R3	0757-0465	6	3	RESISTOR 100K 1% .125W F TC=0+-100	24546	C4-1/8-T0-1003-F
A1R4				NOT ASSIGNED		
A1R5	0698-7218	5	2	RESISTOR 178 1% .05W F TC=0+-100	24546	C3-1/8-T0-178R-G
A1R6	0698-7218	5	1	RESISTOR 178 1% .05W F TC=0+-100	24546	C3-1/8-T0-178R-G
A1R7	0757-0199	3	2	RESISTOR 21.5K 1% .125W F TC=0+-100	24546	C4-1/8-T0-2152-F
A1R8	0698-3440	7	4	RESISTOR 196 1% .125W F TC=0+-100	24546	C4-1/8-T0-196R-F
A1R9	0698-3431	6	2	RESISTOR 23.7 1% .125W F TC=0+-100	03888	PME55-1/8-T0-23R7-F
A1R10	0698-3442	9	2	RESISTOR 237 1% .125W F TC=0+-100	24546	C4-1/8-T0-237R-F
A1R11	0757-0465	6	1	RESISTOR 100K 1% .125W F TC=0+-100	24546	C4-1/8-T0-1003-F
A1R12	0757-0465	6	1	RESISTOR 100K 1% .125W F TC=0+-100	24546	C4-1/8-T0-1003-F
A1R13	1810-0369	4	1	NETWORK-RES 6-SIP100.0K OHM X 5	11236	750-61-R100K
A1R14	0757-0438	3	1	RESISTOR 5.11K 1% .125W F TC=0+-100	24546	C4-1/8-T0-5111-F
A1R15	0698-3442	9	1	RESISTOR 237 1% .125W F TC=0+-100	24546	C4-1/8-T0-237R-F
A1R16	1810-0367	2	1	NETWORK-RES 6-SIP4.7K OHM X 5	01121	206A472
A1R17	0757-0401	0	2	RESISTOR 100 1% .125W F TC=0+-100	24546	C4-1/8-T0-101-F
A1R18	0757-0401	0	1	RESISTOR 100 1% .125W F TC=0+-100	24546	C4-1/8-T0-101-F
A1R19	0757-0199	3	1	RESISTOR 21.5K 1% .125W F TC=0+-100	24546	C4-1/8-T0-2152-F
A1R20	0757-0279	0	2	RESISTOR 3.16K 1% .125W F TC=0+-100	24546	C4-1/8-T0-3161-F
A1R21	0757-0428	1	3	RESISTOR 1.62K 1% .125W F TC=0+-100	24546	C4-1/8-T0-1621-F
A1R22	0757-0416	7	1	RESISTOR 511 1% .125W F TC=0+-100	24546	C4-1/8-T0-511R-F
A1R23	2100-0567	0	3	RESISTOR-TRMR 2K 10% C TOP-ADJ 1-TRN	28480	2100-0567
A1R24	0757-0428	1	1	RESISTOR 1.62K 1% .125W F TC=0+-100	24546	C4-1/8-T0-1621-F
A1R25	0757-0288	1	3	RESISTOR 9.09K 1% .125W F TC=0+-100	19701	MF4C1/8-T0-9091-F
A1R26	0757-0442	9	1	RESISTOR 10K 1% .125W F TC=0+-100	24546	C4-1/8-T0-1002-F
A1R27	2100-0567	0	1	RESISTOR-TRMR 2K 10% C TOP-ADJ 1-TRN	28480	2100-0567
A1R28	0698-0082	7	2	RESISTOR 464 1% .125W F TC=0+-100	24546	C4-1/8-T0-4640-F
A1R29	0757-0288	1	1	RESISTOR 9.09K 1% .125W F TC=0+-100	19701	MF4C1/8-T0-9091-F
A1R30	0757-0288	1	1	RESISTOR 9.09K 1% .125W F TC=0+-100	19701	MF4C1/8-T0-9091-F
A1R31	0757-0279	0	1	RESISTOR 3.16K 1% .125W F TC=0+-100	24546	C4-1/8-T0-3161-F
A1R32	0698-3162	0	1	RESISTOR 46.4K 1% .125W F TC=0+-100	24546	C4-1/8-T0-4642-F
A1R33	0757-0280	3	1	RESISTOR 1K 1% .125W F TC=0+-100	24546	C4-1/8-T0-1001-F
A1R34	0757-0428	1	1	RESISTOR 1.62K 1% .125W F TC=0+-100	24546	C4-1/8-T0-1621-F
A1R35	2100-0567	0	1	RESISTOR-TRMR 2K 10% C TOP-ADJ 1-TRN	28480	2100-0567
A1R36	0698-3440	7	1	RESISTOR 196 1% .125W F TC=0+-100	24546	C4-1/8-T0-196R-F
A1R37	0698-3440	7	1	RESISTOR 196 1% .125W F TC=0+-100	24546	C4-1/8-T0-196R-F
A1R38	1810-0405	9	1	NETWORK-RES 8-SIP470.0 OHM X 4	01121	208B471
A1R39	0698-0082	7	1	RESISTOR 464 1% .125W F TC=0+-100	24546	C4-1/8-T0-4640-F
A1R40	0698-3156	2	1	RESISTOR 14.7K 1% .125W F TC=0+-100	24546	C4-1/8-T0-1472-F
A1R41	1810-0374	1	1	NETWORK-RES 8-SIP1.0K OHM X 4	01121	208B102
A1R42	0757-0394	0	1	RESISTOR 51.1 1% .125W F TC=0+-100	24546	C4-1/8-T0-51R1-F
A1R43	0698-0084	9	1	RESISTOR 2.15K 1% .125W F TC=0+-100	24546	C4-1/8-T0-2151-F
A1R44	2100-3357	2	1	RESISTOR-TRMR 500K 10% C SIDE-ADJ 1-TRN	28480	2100-3357
A1R45	0698-3431	6	1	RESISTOR 23.7 1% .125W F TC=0+-100	03888	PME55-1/8-T0-23R7-F
A1R46	0698-3440	7	1	RESISTOR 196 1% .125W F TC=0+-100	24546	C4-1/8-T0-196R-F

See introduction to this section for ordering information
*Indicates factory selected value

Table 6-2. Replaceable Parts (Continued)

Reference Designation	HP Part Number	C D	Qty	Description	Mfr Code	Mfr Part Number
A1S1	3101-2297	0	1	SWITCH ASSEMBLY-PUSHBUTTON	28480	3101-2297
A1S2				P/O AIR1		
A1S3	3101-1977	1	1	SWITCH-SL DPDT SUBMIN .5A 125VAC PC	28480	3101-1977
A1TP1	0360-1682	0	9	TERMINAL-STUD SGL-TUR PRESS-MTG	28480	0360-1682
A1TP2	0360-1682	0		TERMINAL-STUD SGL-TUR PRESS-MTG	28480	0360-1682
A1TP3	0360-1682	0		TERMINAL-STUD SGL-TUR PRESS-MTG	28480	0360-1682
A1TP4	0360-1682	0		TERMINAL-STUD SGL-TUR PRESS-MTG	28480	0360-1682
A1TP5	0360-1682	0		TERMINAL-STUD SGL-TUR PRESS-MTG	28480	0360-1682
A1TP6	0360-1682	0		TERMINAL-STUD SGL-TUR PRESS-MTG	28480	0360-1682
A1TP7	0360-1682	0		TERMINAL-STUD SGL-TUR PRESS-MTG	28480	0360-1682
A1TP8	0360-1682	0		TERMINAL-STUD SGL-TUR PRESS-MTG	28480	0360-1682
A1TP9	0360-1682	0		TERMINAL-STUD SGL-TUR PRESS-MTG	28480	0360-1682
A1U1	1820-2131	3	1	IC 3870 MICROCOMPUTER	04713	MC3870P
	1200-0552	4	8	SOCKET-IC 40-CONT DIP-SLDR	28480	1200-0552
A1U2	1820-2312	2	1	IC MULTIPLE REGISTER COUNTER	28480	1820-2312
	1200-0552	4		SOCKET-IC 40-CONT DIP-SLDR	28480	1200-0552
A1U3	1820-1747	5	1	IC GATE-CMOS NAND QUAD 2-INP	04713	MC14011BCP
A1U4	1820-2228	9	1	IC LCH CMOS NAND R-S QUAD	04713	MC14044BCP
A1U5	1820-1266	3	2	IC BFR CMOS NON-INV HEX	07263	40097PC
A1U6	1820-1266	3		IC BFR CMOS NON-INV HEX	07263	40097PC
A1U7	1826-0501	9	1	IC MULTIPLXR 2-CHAN-ANLG TRIPLE 16-DIP-P	04713	MC14053BCP
A1U8	1820-1466	5	1	IC FF CMOS D-TYPE POS-EDGE-TRIG COM	07263	40174PC
A1U9	1826-0544	0	1	V REF 8-DIP-C	04713	MC1403U
A1U10	1820-2333	7	1	IC 6801 MICROCOMPUTER	28480	1820-2333
	1200-0552	4		SOCKET-IC 40-CONT DIP-SLDR	28480	1200-0552
A1U11	1820-1216	3	1	IC DCDR TTL LS 3-TO-8-LINE 3-INP	01295	SN74LS138N
A1U12	1820-2113	1	1	HP-IC BUS INTERFACE MC68488	04713	MC68488L
	1200-0552	4		SOCKET-IC 40-CONT DIP-SLDR	28480	1200-0552
A1U13	1826-0315	3	1	IC OP AMP GP QUAD 14-DIP-P PKG	27014	LM348N
A1U14	1820-1492	7	1	IC BFR TTL LS INV HEX 1-INP	01295	SN74LS368AN
A1U15	1820-1416	5	1	IC SCHMITT-TRIG TTL LS INV HEX 1-INP	01295	SN74LS14N
A1U16	1820-0809	8	1	IC RCVR ECL LINE RCVR QUAD 2-INP	04713	MC10115P
	1200-0552	4		SOCKET-IC 40-CONT DIP-SLDR	28480	1200-0552
	1200-0552	4		SOCKET-IC 40-CONT DIP-SLDR	28480	1200-0552
	1200-0552	4		SOCKET-IC 40-CONT DIP-SLDR	28480	1200-0552
	1200-0552	4		SOCKET-IC 40-CONT DIP-SLDR	28480	1200-0552
	0360-0535	0	1	TERMINAL TEST POINT PCB	00000	ORDER BY DESCRIPTION
	0380-0745	6	4	STANDOFF-RVT-ON .187-IN-LG 6-32THD	00000	ORDER BY DESCRIPTION
	0380-0770	7	6	STANDOFF-RVT-ON .875-IN-LG 6-32THD	00000	ORDER BY DESCRIPTION
	0380-0966	3	2	STANDOFF-RVT-ON .08-IN-LG 4-40THD	00000	ORDER BY DESCRIPTION
	0380-1226	0	1	STANDOFF-RVT-ON 1.375-IN-LG 6-32THD	00000	ORDER BY DESCRIPTION
	0510-0002	5	4	THREADED INSERT-NUT 6-32 .062-IN-LG STL	28480	0510-0002
	0590-0184	2	4	THREADED INSERT-NUT 4-40 .058-IN-LG SST	28480	0590-0184
	7204-0003	4			28480	7204-0003

See introduction to this section for ordering information
*Indicates factory selected value

Table 6-2. Replaceable Parts (Continued)

Reference Designation	HP Part Number	C D	Qty	Description	Mfr Code	Mfr Part Number
A2	05315-60012	6	1	DISPLAY ASSEMBLY (SERIES 1924)	28480	05315-60012
A2C1	0180-2929	8	1	CAPACITOR-FXD 68UF+-10% 16VDC TA	28480	0180-2929
A2DS0	1990-0730	3	9	DISPLAY-NUM-SEG 1-CHAR .3-H RED	28480	5082-7611
A2DS1	1990-0730	3		DISPLAY-NUM-SEG 1-CHAR .3-H RED	28480	5082-7611
A2DS2	1990-0730	3		DISPLAY-NUM-SEG 1-CHAR .3 H RED	28480	5082-7611
A2DS3	1990-0730	3		DISPLAY-NUM-SEG 1-CHAR .3-H RED	28480	5082-7611
A2DS4	1990-0730	3		DISPLAY-NUM-SEG 1-CHAR .3-H RED	28480	5082-7611
A2DS5	1990-0730	3		DISPLAY-NUM-SEG 1-CHAR .3-H RED	28480	5082-7611
A2DS6	1990-0730	3		DISPLAY-NUM-SEG 1-CHAR .3-H RED	28480	5082-7611
A2DS7	1990-0730	3		DISPLAY-NUM-SEG 1-CHAR .3-H RED	28480	5082-7611
A2DS8	1990-0730	3		DISPLAY-NUM-SEG 1-CHAR .3-H RED	28480	5082-7611
A2DS9	1990-0757	4	1	LED-VISIBLE LUM-INT=1MCD I _F =35MA-MAX	50522	M057124
A2DS10	1990-0517	4	7	LED-VISIBLE LUM-INT=3MCD I _F =20MA-MAX	28480	5082-4655
A2DS11	1990-0517	4		LED-VISIBLE LUM-INT=3MCD I _F =20MA-MAX	28480	5082-4655
A2DS12	1990-0517	4		LED-VISIBLE LUM-INT=3MCD I _F =20MA-MAX	28480	5082-4655
A2DS13	1990-0517	4		LED-VISIBLE LUM-INT=3MCD I _F =20MA-MAX	28480	5082-4655
A2DS14	1990-0517	4		LED-VISIBLE LUM-INT=3MCD I _F =20MA-MAX	28480	5082-4655
A2DS15	1990-0517	4		LED-VISIBLE LUM-INT=3MCD I _F =20MA-MAX	28480	5082-4655
A2DS16	1990-0517	4		LED-VISIBLE LUM-INT=3MCD I _F =20MA-MAX	28480	5082-4655
A2J1A	1251-5344	9	1	CONNECTOR 12-PIN F POST TYPE	28480	1251-5344
A2J1B	1251-5345	0	1	CONNECTOR 7-PIN F POST TYPE	28480	1251-5345
A2L1	9100-1618	1	1	INDUCTOR RF-CH-PLD 5.6UH 10%	28480	9100-1618
A2R1	0757-0398	4	1	RESISTOR 75 1% .125W F TC=0+-100	24546	C4-1/8-T0-75R0-F
A2R2	0757-0401	0	1	RESISTOR 100 1% .125W F TC=0+-100	24546	C4-1/8-T0-101 F
A2R3	0698-3438	3	1	RESISTOR 147 1% .125W F TC=0+-100	24546	C4-1/8-T0-147R-F
A2R4	0698-3442	9	1	RESISTOR 237 1% .125W F TC=0+-100	24546	C4-1/8-T0-237R-F
A2U1	1820-1199	1	1	IC INV TTL LS HEX 1-INP	01295	SN74LS04N
A2U2	1820-1688	3	1	IC DCDR TTL LS RCD-T0-7-SEG	01295	SN74LS247N
A2U3	1820-2132	4	1	IC DRVR CMOS LED DRVR	32293	1CM7218A
A2XDS0	1200-0679	6	10	SOCKET-IC 14-CONT DIP DIP-SLDR	28480	1200-0679
A2XDS1	1200-0679	6		SOCKET-IC 14-CONT DIP DIP-SLDR	28480	1200-0679
A2XDS2	1200-0679	6		SOCKET-IC 14-CONT DIP DIP-SLDR	28480	1200-0679
A2XDS3	1200-0679	6		SOCKET-IC 14-CONT DIP DIP-SLDR	28480	1200-0679
A2XDS4	1200-0679	6		SOCKET-IC 14-CONT DIP DIP-SLDR	28480	1200-0679
A2XDS5	1200-0679	6		SOCKET-IC 14-CONT DIP DIP-SLDR	28480	1200-0679
A2XDS6	1200-0679	6		SOCKET-IC 14-CONT DIP DIP-SLDR	28480	1200-0679
A2XDS7	1200-0679	6		SOCKET-IC 14-CONT DIP DIP-SLDR	28480	1200-0679
A2XDS8	1200-0679	6		SOCKET-IC 14-CONT DIP DIP-SLDR	28480	1200-0679
A2XU1	1200-0679	6		SOCKET-IC 14-CONT DIP DIP-SLDR	28480	1200-0679
A2XU2	1200-0473	8	1	SOCKET-IC 16-CONT DIP DIP-SLDR	28480	1200-0473
A2XU3	1200-0567	1	1	SOCKET-IC 28-CONT DIP DIP-SLDR	28480	1200-0567
A2 MISCELLANEOUS PARTS						
	0380-0458	8	1	SPACER-RVT-ON .437-IN-LG .152-IN-ID	28480	0380-0458
	1251-3768	7	1	CONTACT-CONN U/W-POST-TYPE MALE DP SLDR	28480	1251-3768

See introduction to this section for ordering information
*Indicates factory selected value

Table 6-2. Replaceable Parts (Continued)

Reference Designation	HP Part Number	C D	Qty	Description	Mfr Code	Mfr Part Number
				NOTE IF A3 OR A4 IS TO BE REPLACED, BOTH ASSEMBLIES MUST BE REPLACED AS A PAIR. ORDER HP PART NUMBER 05316-60100.		
A3A4	05316-60100	4	1	INPUT/AMPLIFIER ASSEMBLY	28480	05316-60100
A3	05316-60003	6	1	INPUT AMP SWITCHES (SERIES 1924)	28480	05316-60100
A3C1	0180-0562	1	1	CAPACITOR-FXD 33UF+-20% 10VDC TA	56289	196D336X0010KA1
A3C2	0160-3879	7	3	CAPACITOR-FXD .01UF +-20% 100VDC CER	28480	0160-3879
A3C3	0160-3879	7		CAPACITOR-FXD .01UF +-20% 100VDC CER	28480	0160-3879
A3C4	0160-3879	7		CAPACITOR-FXD .01UF +-20% 100VDC CER	28480	0160-3879
A3C5	0160-4705	0	2	CAPACITOR-FXD 2.2PF +-5% 500VDC CER	28480	0160-4705
A3C6	0160-5108	9	4	CAPACITOR-FXD .01UF +-10% 500VDC CER	28480	0160-5108
A3C7	0160-4350	1	1	CAPACITOR-FXD 68PF +-5% 200VDC CER 0+-30	28480	0160-4350
A3C8	0160-5108	9		CAPACITOR-FXD .01UF +-10% 500VDC CER	28480	0160-5108
A3C9	0160-3877	5	1	CAPACITOR-FXD 100PF +-20% 200VDC CER	28480	0160-3877
A3C10	0160-4705	0		CAPACITOR-FXD 2.2PF +-5% 500VDC CER	28480	0160-4705
A3C11	0160-5108	9		CAPACITOR-FXD .01UF +-10% 500VDC CER	28480	0160-5108
A3C12	0160-5108	9		CAPACITOR-FXD .01UF +-10% 500VDC CER	28480	0160-5108
A3CR1	1901-0376	6	4	DIODE-GEN PRP 35V 50MA DO-35	28480	1901-0376
A3CR2	1901-0376	6		DIODE-GEN PRP 35V 50MA DO-35	28480	1901-0376
A3CR3	1901-0376	6		DIODE-GEN PRP 35V 50MA DO-35	28480	1901-0376
A3CR4	1901-0376	6		DIODE-GEN PRP 35V 50MA DO-35	28480	1901-0376
A3DS1	1990-0660	8	2	LED-VISIBLE LUM-INT=8MCD IF=20MA-MAX	28480	5082-4597
	4040-1462	0	2	STANDOFF-LED	28480	4040-1462
A3DS2	1990-0660	8		LED-VISIBLE LUM-INT=8MCD IF=20MA-MAX	28480	5082-4597
	4040-1462	0		STANDOFF-LED	28480	4040-1462
A3J1	1250-1594	1	2	CONNECTOR-RF BNC FEM SGL-HOLE-RR 50-OHM	28480	1250-1594
A3J2	1250-1594	1		CONNECTOR-RF BNC FEM SGL-HOLE-RR 50-OHM	28480	1250-1594
A3P1	1251-0603	9	1	CONNECTOR 6-PIN M POST TYPE	28480	1251-0603
A3P2	1251-0600	0	2	CONNECTOR-SGL CONT PIN 1.14-MM-BSC-SZ SQ	28480	1251-0600
A3P3	1251-0600	0		CONNECTOR-SGL CONT PIN 1.14-MM-BSC-SZ SQ	28480	1251-0600
A3R1	1810-0452	6	2	NETWORK-RES 10-SIP MULTI-VALUE	28480	1810-0452
A3R2	2100-3729	2	2	RESISTOR-VAR CONTROL CCP 20K 10% LIN	01121	WP4H048P203UA
A3R3	2100-1788	9	2	RESISTOR-TRMR 500 10% C TOP-ADJ 1-TRN	73138	B2PR500
A3R4	2100-1788	9		RESISTOR-TRMR 500 10% C TOP-ADJ 1-TRN	73138	B2PR500
A3R5	2100-3729	2		RESISTOR-VAR CONTROL CCP 20K 10% LIN	01121	WP4H048P203UA
A3R6	1810-0452	6		NETWORK-RES 10-SIP MULTI-VALUE	28480	1810-0452
A3R7	0698-7097	8	2	RESISTOR 1M 5% .125W CC TC=-600/+1137	01121	BB1055
A3R8	0698-7277	6	2	RESISTOR 51.1K 1% .05W F TC=0+-100	24546	C3-1/8-T0-5112-G
A3R9	0698-7194	6	2	RESISTOR 17.8 1% .05W F TC=0+-100	24546	C3-1/8-T00-17R8-G
A3R10	0757-0472	5	2	RESISTOR 200K 1% .125W F TC=0+-100	24546	C4-1/8-T0-2003-F
A3R11	0698-7188	8	1	RESISTOR 10 1% .05W F TC=0+-100	24546	C3-1/8-T00-10R-G
A3R12	0698-7277	6		RESISTOR 51.1K 1% .05W F TC=0+-100	24546	C3-1/8-T0-5112-G
A3R13	0698-7097	8		RESISTOR 1M 5% .125W CC TC=-600/+1137	01121	BB1055
A3R14	0757-0472	5		RESISTOR 200K 1% .125W F TC=0+-100	24546	C4-1/8-T0-2003-F
A3R15	0698-7194	6		RESISTOR 17.8 1% .05W F TC=0+-100	24546	C3-1/8-T00-17R8-G
A3S1	3101-2124	2	10	SWITCH-PB DPDT ALTNG .25A 115VAC	28480	3101-2124
A3S2	3101-2124	2		SWITCH-PB DPDT ALTNG .25A 115VAC	28480	3101-2124
A3S3	3101-2124	2		SWITCH-PB DPDT ALTNG .25A 115VAC	28480	3101-2124
A3S4	3101-2124	2		SWITCH-PB DPDT ALTNG .25A 115VAC	28480	3101-2124
A3S5	3101-2124	2		SWITCH-PB DPDT ALTNG .25A 115VAC	28480	3101-2124
A3S6	3101-2124	2		SWITCH-PB DPDT ALTNG .25A 115VAC	28480	3101-2124
A3S7	3101-2124	2		SWITCH-PB DPDT ALTNG .25A 115VAC	28480	3101-2124
A3S8	3101-2124	2		SWITCH-PB DPDT ALTNG .25A 115VAC	28480	3101-2124
A3S9	3101-2124	2		SWITCH-PB DPDT ALTNG .25A 115VAC	28480	3101-2124
A3S10	3101-2124	2		SWITCH-PB DPDT ALTNG .25A 115VAC	28480	3101-2124
				A3 MISCELLANEOUS PARTS		
	05315-20201	1	2	SPACER-POTS TRIGGER LEVEL	28480	05315-20201

See introduction to this section for ordering information
*Indicates factory selected value

Table 6-2. Replaceable Parts (Continued)

Reference Designation	HP Part Number	C D	Qty	Description	Mfr Code	Mfr Part Number
A4	05315-60004	6	1	NOTE IF A3 OR A4 IS TO BE REPLACED, BOTH ASSEMBLIES MUST BE REPLACED AS A PAIR. ORDER HP PART NUMBER 05316-60100. INPUT AMPLIFIER (SERIES 1824)	28480	05315-60004
A4C1	0180-2815	1	3	CAPACITOR-FXD 100UF+-20% 10VDC TA	28480	0180-2815
A4C2	0160-3875	3	2	CAPACITOR-FXD 22PF +-5% 200VDC CER 0+-30	28480	0160-3875
A4C3	0180-2815	1		CAPACITOR-FXD 100UF+-20% 10VDC TA	28480	0180-2815
A4C4	0180-2815	1		CAPACITOR-FXD 100UF+-20% 10VDC TA	28480	0180-2815
A4C5	0160-3877	5	2	CAPACITOR-FXD 100PF +-20% 200VDC CER	28480	0160-3877
A4C6	0160-3879	7	13	CAPACITOR-FXD .01UF +-20% 100VDC CER	28480	0160-3879
A4C7	0160-3879	7		CAPACITOR-FXD .01UF +-20% 100VDC CER	28480	0160-3879
A4C8	0160-3879	7		CAPACITOR-FXD .01UF +-20% 100VDC CER	28480	0160-3879
A4C9	0160-3879	7		CAPACITOR-FXD .01UF +-20% 100VDC CER	28480	0160-3879
A4C10	0160-3879	7		CAPACITOR-FXD .01UF +-20% 100VDC CER	28480	0160-3879
A4C11	0160-3879	7		CAPACITOR-FXD .01UF +-20% 100VDC CER	28480	0160-3879
A4C12	0160-3875	3		CAPACITOR-FXD 22PF +-5% 200VDC CER 0+-30	28480	0160-3875
A4C13	0160-3879	7		CAPACITOR-FXD .01UF +-20% 100VDC CER	28480	0160-3879
A4C14	0160-3879	7		CAPACITOR-FXD .01UF +-20% 100VDC CER	28480	0160-3879
A4C15	0160-3879	7		CAPACITOR-FXD .01UF +-20% 100VDC CER	28480	0160-3879
A4C16	0180-2662	6	2	CAPACITOR-FXD 10UF+-10% 10VDC TA	25088	D4R7GS1A10K
A4C17	0160-3879	7		CAPACITOR-FXD .01UF +-20% 100VDC CER	28480	0160-3879
A4C18	0160-3877	5		CAPACITOR-FXD 100PF +-20% 200VDC CER	28480	0160-3877
A4C19	0160-3879	7		CAPACITOR-FXD .01UF +-20% 100VDC CER	28480	0160-3879
A4C20	0180-2662	6		CAPACITOR-FXD 10UF+-10% 10VDC TA	25088	D4R7GS1A10K
A4C21	0160-3879	7		CAPACITOR-FXD .01UF +-20% 100VDC CER	28480	0160-3879
A4C22	0160-3879	7		CAPACITOR-FXD .01UF +-20% 100VDC CER	28480	0160-3879
A4CR1	1901-0518	8	2	DIODE-SM SIG SCHOTTKY	28480	1901-0518
A4CR2	1901-0518	8		DIODE-SM SIG SCHOTTKY	28480	1901-0518
A4P1	1251-3768	7	3	CONTACT-CONN U/W-POST-TYPE MALE DPSLDR	28480	1251-3768
A4P2	1251-5282	4	1	CONNECTOR 12-PIN M POST TYPE	28480	1251-5282
A4Q1	1854-0345	8	2	TRANSISTOR NPN 2N5179 SI T0-72 PD=200MW	04713	2N5179
A4Q2	1855-0213	1	2	TRANSISTOR-JFET DUAL N-CHAN D-MODE T0-7B	28480	1855-0213
A4Q3	1854-0345	8		TRANSISTOR NPN 2N5179 SI T0-72 PD=200MW	04713	2N5179
A4Q4	1855-0213	1		TRANSISTOR-JFET DUAL N-CHAN D-MODE T0-7B	28480	1855-0213
A4R1	2100-1984	7	2	RESISTOR-TRMR 100 10% C TOP-ADJ 1-TRN	73138	82PR100
A4R2	0698-3441	8	3	RESISTOR 215 1% .125W F TC=0+-100	24546	C4-1/8-T0-215R-F
A4R3	0757-0416	7	4	RESISTOR 511 1% .125W F TC=0+-100	24546	C4-1/8-T0-511R-F
A4R4	0698-3449	6	2	RESISTOR 28.7K 1% .125W F TC=0+-100	24546	C4-1/8-T0-2872-F
A4R5	0757-0278	9	2	RESISTOR 1.78K 1% .125W F TC=0+-100	24546	C4-1/8-T0-1781-F
A4R6	0698-7218	5	2	RESISTOR 178 1% .05W F TC=0+-100	24546	C3-1/8-T0-178R-G
A4R7	0698-7228	7	3	RESISTOR 464 1% .05W F TC=0+-100	24546	C3-1/8-T0-464R-G
A4R8				NOT ASSIGNED		
A4R9	0698-7228	7		RESISTOR 464 1% .05W F TC=0+-100	24546	C3-1/8-T0-464R-G
A4R10	0698-7209	4	1	RESISTOR 75 1% .05W F TC=0+-100	24546	C3-1/8-T00-75R0-G
A4R11	0698-3441	8		RESISTOR 215 1% .125W F TC=0+-100	24546	C4-1/8-T0-215R-F
A4R12	0757-0417	8	2	RESISTOR 562 1% .125W F TC=0+-100	24546	C4-1/8-T0-562R-F
A4R13	0698-7228	7		RESISTOR 464 1% .05W F TC=0+-100	24546	C3-1/8-T0-464R-G
A4R14	0757-0401	0	1	RESISTOR 100 1% .125W F TC=0+-100	24546	C4-1/8-T0-101-F
A4R15	0698-3449	6		RESISTOR 28.7K 1% .125W F TC=0+-100	24546	C4-1/8-T0-2872-F
A4R16	0757-0278	9		RESISTOR 1.78K 1% .125W F TC=0+-100	24546	C4-1/8-T0-1781-F
A4R17	1810-0219	3	1	NETWORK-RES 8-SIP220.0 OHM X 4	01121	208B221
A4R19	0698-7218	5		RESISTOR 178 1% .05W F TC=0+-100	24546	C3-1/8-T0-178R-G
A4R20	1810-0203	5	1	NETWORK-RES 8-SIP470.0 OHM X 7	01121	208A471
A4R21	0757-0439	4	2	RESISTOR 6.81K 1% .125W F TC=0+-100	24546	C4-1/8-T0-6811-F
A4R22	0757-0418	9	2	RESISTOR 619 1% .125W F TC=0+-100	24546	C4-1/8-T0-619R-F
A4R23	0757-0418	9		RESISTOR 619 1% .125W F TC=0+-100	24546	C4-1/8-T0-619R-F
A4R24	0757-0283	6	2	RESISTOR 2K 1% .125W F TC=0+-100	24546	C4-1/8-T0-2001-F
A4R25	0757-0416	7		RESISTOR 511 1% .125W F TC=0+-100	24546	C4-1/8-T0-511R-F
A4R26	0757-0416	7		RESISTOR 511 1% .125W F TC=0+-100	24546	C4-1/8-T0-511R-F
A4R27	0757-0421	4	2	RESISTOR 825 1% .125W F TC=0+-100	24546	C4-1/8-T0-825R-F
A4R28	0698-3441	8		RESISTOR 215 1% .125W F TC=0+-100	24546	C4-1/8-T0-215R-F
A4R29	0757-0439	4		RESISTOR 6.81K 1% .125W F TC=0+-100	24546	C4-1/8-T0-6811-F
A4R30	0757-0417	8		RESISTOR 562 1% .125W F TC=0+-100	24546	C4-1/8-T0-562R-F
A4R31	0757-0421	4		RESISTOR 825 1% .125W F TC=0+-100	24546	C4-1/8-T0-825R-F
A4R32	2100-1984	7		RESISTOR-TRMR 100 10% C TOP-ADJ 1-TRN	73138	82PR100
A4R33	0757-0416	7		RESISTOR 511 1% .125W F TC=0+-100	24546	C4-1/8-T0-511R-F
A4R34	0757-0283	6		RESISTOR 2K 1% .125W F TC=0+-100	24546	C4-1/8-T0-2001-F
A4TP1	0360-0124	3	1	CONNECTOR-SGL COHT PIN .04-IN-RSC-SZ RND	28480	0360-0124
A4U1	1858-0040	8	1	TRANSISTOR ARRAY 16-PIN PLSTC DIP	0192B	CA3127E
A4U2	1826-0426	7	1	IC COMPARATOR HS DUAL 16-DIP-C PKG	34335	AM687ADL
A4U3	1821-0001	4	1	TRANSISTOR ARRAY 14-PIN PLSTC DIP	0192B	CA3046

See introduction to this section for ordering information
*Indicates factory selected value

Table 6-2. Replaceable Parts (Continued)

Reference Designation	HP Part Number	C D	Qty	Description	Mfr Code	Mfr Part Number
A5	05315-60005	7	1	DISPLAY SUPPORT BOARD (NO SERIES)	28480	05315-60005
ASP 1	1251-3768	7		CONTACT-CONN U/W-POST-TYPE MALE DP5LDR	28480	1251-3768
ASP 2	1251-3768	7		CONTACT-CONN U/W-POST-TYPE MALE DP5LDR	28480	1251-3768

See introduction to this section for ordering information
*Indicates factory selected value

Table 6-2. Replaceable Parts (Continued)

Reference Designation	HP Part Number	C D	Qty	Description	Mfr Code	Mfr Part Number
A6	05316-60010		5	DIGITAL-TO-ANALOG CONVERTER (SERIES 1924)	28480	05316-60010
A6C1	0160-0576	5	2	CAPACITOR-FXD .01UF +-20% 50VDC CER	28480	0160-0576
A6C2	0160-3879	7	12	CAPACITOR-FXD .01UF +-20% 100VDC CER	28480	0160-3879
A6C3	0160-3878	6	2	CAPACITOR-FXD 1000PF +-20% 100VDC CER	28480	0160-3878
A6C4	0160-3879	7	2	CAPACITOR-FXD .01UF +-20% 100VDC CER	28480	0160-3879
A6C5	0160-4521	8	2	CAPACITOR-FXD 12PF +-5% 200VDC CER 0+-30	51642	200-200-NP0-120J
A6C6	0160-3878	6		CAPACITOR-FXD 1000PF +-20% 100VDC CER	28480	0160-3878
A6C7	0160-4521	8		CAPACITOR-FXD 12PF +-5% 200VDC CER 0+-30	51642	200-200-NP0-120J
A6C8	0160-0576	5		CAPACITOR-FXD .01UF +-20% 50VDC CER	28480	0160-0576
A6C9	0160-3879	7		CAPACITOR-FXD .01UF +-20% 100VDC CER	28480	0160-3879
A6C10	0160-3879	7		CAPACITOR-FXD .01UF +-20% 100VDC CER	28480	0160-3879
A6C11	0160-3879	7		CAPACITOR-FXD .01UF +-20% 100VDC CER	28480	0160-3879
A6C12	0160-3879	7		CAPACITOR-FXD .01UF +-20% 100VDC CER	28480	0160-3879
A6C13	0160-3879	7		CAPACITOR-FXD .01UF +-20% 100VDC CER	28480	0160-3879
A6C14	0180-0562	1	3	CAPACITOR-FXD 33UF+-20% 10VDC TA	56289	1960336X0010KA1
A6C15	0160-3879	7		CAPACITOR-FXD .01UF +-20% 100VDC CER	28480	0160-3879
A6C16	0160-3879	7		CAPACITOR-FXD .01UF +-20% 100VDC CER	28480	0160-3879
A6C17	0180-0562	1		CAPACITOR-FXD 33UF+-20% 10VDC TA	56289	1960336X0010KA1
A6C18	0160-3879	7		CAPACITOR-FXD .01UF +-20% 100VDC CER	28480	0160-3879
A6C19	0160-3879	7		CAPACITOR-FXD .01UF +-20% 100VDC CER	28480	0160-3879
A6C20	0160-3879	7		CAPACITOR-FXD .01UF +-20% 100VDC CER	28480	0160-3879
A6CR1	1901-0518	8	2	DIODE-SM SIG SCHOTTKY	28480	1901-0518
A6CR2	1901-0518	8		DIODE-SM SIG SCHOTTKY	28480	1901-0518
A6P2	1251-5063	9	1	CONNECTOR 6-PIN M POST TYPE	28480	1251-5063
A6R1	2100-3273	1	2	RESISTOR-TRMR 2K 10% C SIDE-ADJ 1-TRN	28480	2100-3273
A6R2	2100-3354	9	2	RESISTOR-TRMR 50K 10% C SIDE-ADJ 1-TRN	28480	2100-3354
A6R3	2100-3273	1		RESISTOR-TRMR 2K 10% C SIDE-ADJ 1-TRN	28480	2100-3273
A6R4	2100-3354	9		RESISTOR-TRMR 50K 10% C SIDE-ADJ 1-TRN	28480	2100-3354
A6R5	0698-6612	1	4	RESISTOR 2K .1% .125W F TC=0+-50	28480	0698-6612
A6R6	0698-6612	1		RESISTOR 2K .1% .125W F TC=0+-50	28480	0698-6612
A6R7	0698-8957	1	2	RESISTOR 500K 1% .125W F TC=0+-100	28480	0698-8957
A6R8	0757-0280	3	11	RESISTOR 1K 1% .125W F TC=0+-100	24546	C4-1/8-T0-1001-F
A6R9	0698-8957	1		RESISTOR 500K 1% .125W F TC=0+-100	28480	0698-8957
A6R10	0757-0280	3		RESISTOR 1K 1% .125W F TC=0+-100	24546	C4-1/8-T0-1001-F
A6R11	0698-6612	1		RESISTOR 2K .1% .125W F TC=0+-50	28480	0698-6612
A6R12	0698-6612	1		RESISTOR 2K .1% .125W F TC=0+-50	28480	0698-6612
A6R13	0757-0280	3		RESISTOR 1K 1% .125W F TC=0+-100	24546	C4-1/8-T0-1001-F
A6R14	0757-0280	3		RESISTOR 1K 1% .125W F TC=0+-100	24546	C4-1/8-T0-1001-F
A6R15	0757-0280	3		RESISTOR 1K 1% .125W F TC=0+-100	24546	C4-1/8-T0-1001-F
A6R16	0757-0280	3		RESISTOR 1K 1% .125W F TC=0+-100	24546	C4-1/8-T0-1001-F
A6R17	0757-0465	6	1	RESISTOR 100K 1% .125W F TC=0+-100	24546	C4-1/8-T0-1003-F
A6TP1	0360-1682	0	1	TERMINAL-STUD SGL-TUR PRESS-MTG	28480	0360-1682
A6U1	1826-0639	4	2	IC CONV 8-B-D/A 16-DIP-P PKG	24355	AD7524JN
A6U2	1826-0315	3	1	IC OP AMP GP QUAD 14-DIP-P PKG	27014	LM348N
A6U3	1826-0639	4		IC CONV 8-B-D/A 16-DIP-P PKG	24355	AD7524JN
A6U4	1826-0501	9	2	IC MULTIPLXR 2-CHAN-ANLG TRIPLE 16-DIP-P	04713	MC14053BCP
A6U5	1826-0501	9		IC MULTIPLXR 2-CHAN-ANLG TRIPLE 16-DIP-P	04713	MC14053BCP
A6U6	1826-0139	9	1	IC OP AMP GP DUAL 8-DIP-P PKG	0192B	CA1458G
				A6 MISCELLANEOUS PARTS		
	0380-1041	7	1	STANDOFF-RVT-DN 2.08-IN-LG 4-40THD	00000	ORDER BY DESCRIPTION
A7	05316-60008		1	REFERENCE OSCILLATOR (SERIES 1924)	28480	05316-60008
A7C1	0160-2204	0	1	CAPACITOR-FXD 100PF +-5% 300VDC MICA	28480	0160-2204
A7C2	0140-0210	2	1	CAPACITOR-FXD 270PF +-5% 300VDC MICA	72136	DM15F271J0300WV1CR
A7C3	0160-4554	7	4	CAPACITOR-FXD .01UF +-20% 50VDC CER	28480	0160-4554
A7C4	0121-0105	4	1	CAPACITOR-V TRMR-CER 9-35PF 200V PC-MTG	52763	304324 9/35PF N650
A7C5	0160-4554	7		CAPACITOR-FXD .01UF +-20% 50VDC CER	28480	0160-4554
A7C6	0160-0196	5	1	CAPACITOR-FXD 24PF +-5% 300VDC MICA	28480	0160-0196
A7C7	0121-0059	7	1	CAPACITOR-V TRMR-CER 2-8PF 350V PC-MTG	52763	304324 2/8PF NPO
A7P1	1251-4510	9	2	CONNECTOR 6-PIN M POST TYPE	28480	1251-4510
A7Q1	1854-0215	1	2	TRANSISTOR NPN SI PD=350MW FT=300MHZ	04713	2N3904
A7Q2	1854-0215	1		TRANSISTOR NPN SI PD=350MW FT=300MHZ	04713	2N3904
A7R1	0757-0280	3		RESISTOR 1K 1% .125W F TC=0+-100	24546	C4-1/8-T0-1001-F
A7R2	0757-0280	3		RESISTOR 1K 1% .125W F TC=0+-100	24546	C4-1/8-T0-1001-F
A7R3	0757-0199	3	2	RESISTOR 21.5K 1% .125W F TC=0+-100	24546	C4-1/8-T0-2152-F
A7R4	0757-0199	3		RESISTOR 21.5K 1% .125W F TC=0+-100	24546	C4-1/8-T0-2152-F
A7R5	0698-3443	0	1	RESISTOR 287 1% .125W F TC=0+-100	24546	C4-1/8-T0-287R-F

See introduction to this section for ordering information
*Indicates factory selected value

Table 6-2. Replaceable Parts (Continued)

Reference Designation	HP Part Number	C D	Qty	Description	Mfr Code	Mfr Part Number
A7R6	0757-0280	3		RESISTOR 1K 1% .125W F TC=0+-100	24546	C4-1/8-T0-1001-F
A7Y1	0410-0423	2	1	CRYSTAL-QUARTZ 10.000 MHZ	28480	0410-0423
	1400-0957	7	4	A7 MISCELLANEOUS PARTS BRACKET-RTANG .475-LG X .183-LG .25-WD	28480	1400-0957
A7	05316-60007	0	1	TCXO OSCILLATOR OPTION 001 (SERIES 2004)	28480	05316-60007
A7C1	0180-0562	1		CAPACITOR-FXD 33UF+-20% 10VDC TA	56289	196D336X0010KA1
A7P1	1251-4510	9		CONNECTOR 6-PIN M POST TYPE	28480	1251-4510
A7R1	0757-0416	7	2	RESISTOR 511 1% .125W F TC=0+-100	24546	C4-1/8-T0-511R-F
A7R2	0757-0416	7		RESISTOR 511 1% .125W F TC=0+-100	24546	C4-1/8-T0-511R-F
A7Y1	0960-0612	6	1	CRYSTAL OSCILLATOR	28480	0960-0612
	1400-0957	7		A7 MISCELLANEOUS PARTS BRACKET-RTANG .475-LG X .183-LG .25-WD	28480	1400-0957
A7	05316-60013	8	1	OPTION 004 BOARD ASSEMBLY-REGULATOR (SERIES 2052)	28480	05316-60013
A7C1	0180-2662	6	1	CAPACITOR-FXD 10UF+-10% 10VDC TA	25088	D4R7GS1A10K
A7C2	0160-4554	7		CAPACITOR-FXD .01UF +-20% 50VDC CER	28480	0160-4554
A7C3	0160-4554	7		CAPACITOR-FXD .01UF +-20% 50VDC CER	28480	0160-4554
A7C4	0180-0418	6	1	CAPACITOR-FXD 1UF+-20% 35VDC TA	28480	0180-0418
A7C5	0160-4511	0	1	CAPACITOR-FXD 220PF +-5% 100VDC CER	28480	0160-4511
A7CR1	1902-3059	0	1	DIODE-ZNR 3.83V 5% D0-35 PD=.4W	28480	1902-3059
A7P1	1251-4510	9	1	CONNECTOR 6-PIN M POST TYPE	28480	1251-4510
A7Q1	1853-0363	8	1	TRANSISTOR PNP SI PD=50W FT=20MHZ	03508	X45H281
A7R1	0757-0428	1	2	RESISTOR 1.62K 1% .125W F TC=0+-100	24546	C4-1/8-T0-1621-F
A7R2	2100-3349	2	1	RESISTOR-TRMR 100 10% C SIDE-ADJ 1-TRN	28480	2100-3349
A7R3	0757-0280	3		RESISTOR 1K 1% .125W F TC=0+-100	24546	C4-1/8-T0-1001-F
A7R4	0757-0280	3		RESISTOR 1K 1% .125W F TC=0+-100	24546	C4-1/8-T0-1001-F
A7R5	0757-0428	1		RESISTOR 1.62K 1% .125W F TC=0+-100	24546	C4-1/8-T0-1621-F
A7R6	0757-0401	0	1	RESISTOR 100 1% .125W F TC=0+-100	24546	C4-1/8-T0-101-F
A7U1	1820-0493	6	1	IC OP AMP GP 8-DIP-P PKG	27014	LM307N
A7U2	1826-0544	0	1	V REF 8-DIP-C	04713	MC1403U
A7W1	05316-60103	7	1	CABLE-OSCILLATOR	28480	05316-60103
	1205-0219	0	1	A7 MISCELLANEOUS PARTS HEAT SINK SGL T0-66-CS	28480	1205-0219
	0340-0864	6	1	INSULATOR-XSTR THRM-CNDCT	28480	0340-0864
	3050-0791	6	1	INSULATOR-XSTR NYLON	28480	3050-0791
	1400-0957	7		BRACKET-RTANG .475-LG X .183-LG .25-WD	28480	1400-0957
A13	0960-0603	5	1	OPTION 004 OVEN OSCILLATOR MODULE (NO SERIES)	28480	0960-0603
A13C1	0160-4556	9	1	CAPACITOR-FXD 1000PF +-20% 100VDC CER	16299	CAC02X7R102M100A
A13E1	9170-0029	3	2	CORE-SHIELDING BEAD	28480	9170-0029
A13E2	9170-0029	3		CORE-SHIELDING BEAD	28480	9170-0029
	05316-00006	3	1	BRACKET-OVEN OSCILLATOR	28480	05316-00006
				NOTE A13 PART NUMBER 0960-0603 DOES NOT INCLUDE A13C1, E1, OR E2.		

See introduction to this section for ordering information
*Indicates factory selected value

Model 5316A
Replaceable Parts

Table 6-2. Replaceable Parts (Continued)

Reference Designation	HP Part Number	C D	Qty	Description	Mfr Code	Mfr Part Number
A8	0960-0444	2	1	POWER MODULE (NO SERIES NO.)	28480	0960-0444
A8	4040-1083	1	1	SAFETY COVER-PLASTIC-FOR A8	28480	4040-1083
A8F1	2110-0044	1	1	.3A SB 100V-120V OPERATION	28480	2110-0044
A8F1	2110-0320	1	1	.15A SB 220V-240V OPERATION	28480	2110-0320
A9	05315-60009	1	1	OPTION 003 CHANNEL C AMPLIFIER (SERIES 1824)	28480	05315-60009
A9C1	0160-0576	5	16	CAPACITOR-FXD .1UF +-20% 50VDC CER	28480	0160-0576
A9C2	0180-2662	6	4	CAPACITOR-FXD 10UF+-10% 10VDC TA	25088	D4R7GS1A10K
A9C4	0160-0576	5		CAPACITOR-FXD .1UF +-20% 50VDC CER	28480	0160-0576
A9C5	0160-0576	5		CAPACITOR-FXD .1UF +-20% 50VDC CER	28480	0160-0576
A9C6	0160-0576	5		CAPACITOR-FXD .1UF +-20% 50VDC CER	28480	0160-0576
A9C7	0180-2662	6		CAPACITOR-FXD 10UF+-10% 10VDC TA	25088	D4R7GS1A10K
A9C8	0180-2662	6		CAPACITOR-FXD 10UF+-10% 10VDC TA	25088	D4R7GS1A10K
A9C9	0160-3878	6	1	CAPACITOR-FXD 1000PF +-20% 100VDC CER	28480	0160-3878
A9C10	0160-0576	5		CAPACITOR-FXD .1UF +-20% 50VDC CER	28480	0160-0576
A9C11	0160-0576	5		CAPACITOR-FXD .1UF +-20% 50VDC CER	28480	0160-0576
A9C12	0160-0576	5		CAPACITOR-FXD .1UF +-20% 50VDC CER	28480	0160-0576
A9C13	0160-0576	5		CAPACITOR-FXD .1UF +-20% 50VDC CER	28480	0160-0576
A9C14	0160-0576	5		CAPACITOR-FXD .1UF +-20% 50VDC CER	28480	0160-0576
A9C15	0160-0576	5		CAPACITOR-FXD .1UF +-20% 50VDC CER	28480	0160-0576
A9C16	0160-0576	5		CAPACITOR-FXD .1UF +-20% 50VDC CER	28480	0160-0576
A9C17	0160-0576	5		CAPACITOR-FXD .1UF +-20% 50VDC CER	28480	0160-0576
A9C18	0160-0576	5		CAPACITOR-FXD .1UF +-20% 50VDC CER	28480	0160-0576
A9C19	0160-0576	5		CAPACITOR-FXD .1UF +-20% 50VDC CER	28480	0160-0576
A9C20	0180-2662	6		CAPACITOR-FXD 10UF+-10% 10VDC TA	25088	D4R7GS1A10K
A9C21	0160-0127	2	1	CAPACITOR-FXD 1UF +-20% 25VDC CER	28480	0160-0127
A9C22	0160-0576	5		CAPACITOR-FXD .1UF +-20% 50VDC CER	28480	0160-0576
A9C23	0160-0576	5		CAPACITOR-FXD .1UF +-20% 50VDC CER	28480	0160-0576
A9CR1	1901-0535	9	4	DIODE-SM SIG SCHOTTKY	28480	1901-0535
A9CR2	1901-0535	9		DIODE-SM SIG SCHOTTKY	28480	1901-0535
A9CR3	1901-0050	3	2	DIODE-SWITCHING 80V 200MA 2NS DO-35	28480	1901-0050
A9CR4	1901-0050	3		DIODE-SWITCHING 80V 200MA 2NS DO-35	28480	1901-0050
A9CR5	1902-0041	4	1	DIODE-ZNR 5.11V 5% DO-35 PD=.4W	28480	1902-0041
A9CR6	1901-0535	9		DIODE-SM SIG SCHOTTKY	28480	1901-0535
A9CR7	1901-0535	9		DIODE-SM SIG SCHOTTKY	28480	1901-0535
A9CR8	1902-0551	1	1	DIODE-ZNR 6.19V 5% DO-15 PD=1W TC=+.022%	28480	1902-0551
A9F1	2110-0301	1	1	FUSE .125A 125V .281X.093	28480	2110-0301
A9L1	9100-1788	6	2	CHOKE-WIDE BAND ZMAX=680 OHMS 180 MHZ	02114	VK200 20/48
A9L2	9100-1788	6		CHOKE-WIDE BAND ZMAX=680 OHMS 180 MHZ	02114	VK200 20/48
A9L3	9100-2272	5	3	INDUCTOR RF-CH-MLD 47UH 10% .105DX.26LG	28480	9100-2272
A9L4	9100-2272	5		INDUCTOR RF-CH-MLD 47UH 10% .105DX.26LG	28480	9100-2272
A9L5	9100-2272	5		INDUCTOR RF-CH-MLD 47UH 10% .105DX.26LG	28480	9100-2272
A9P1A	1251-1556	7	24	CONNECTOR-SGL CONT SKT .018-IN-BSC-SZ	28480	1251-1556
A9P1B	1251-5621	5	1	CONNECTOR 12-PIN F POST TYPE	28480	1251-5621
A9Q1	1853-0281	9	1	TRANSISTOR PNP 2N2907A SI TO-18 PD=400MW	04713	2N2907A
A9Q2	1855-0420	2	2	TRANSISTOR J-FET 2N4391 N-CHAN D-MODE	01295	2N4391
A9Q3	1855-0420	2		TRANSISTOR J-FET 2N4391 N-CHAN D-MODE	01295	2N4391
A9R1	0698-7234	5	5	RESISTOR 825 1% .05W F TC=0+-100	24546	C3-1/8-T0-825R-G
A9R2	0698-7234	5		RESISTOR 825 1% .05W F TC=0+-100	24546	C3-1/8-T0-825R-G
A9R3	0698-7205	0	2	RESISTOR 51.1 1% .05W F TC=0+-100	24546	C3-1/8-T00-51R1-G
A9R4	0698-7234	5		RESISTOR 825 1% .05W F TC=0+-100	24546	C3-1/8-T0-825R-G
A9R5	0698-7205	0		RESISTOR 51.1 1% .05W F TC=0+-100	24546	C3-1/8-T00-51R1-G
A9R6	0698-7258	3	1	RESISTOR 8.25K 1% .05W F TC=0+-100	24546	C3-1/8-T0-8251-G
A9R7	0698-7196	8	2	RESISTOR 21.5 1% .05W F TC=0+-100	24546	C3-1/8-T00-21R5-G
A9R8	0698-7196	8		RESISTOR 21.5 1% .05W F TC=0+-100	24546	C3-1/8-T00-21R5-G
A9R9	2100-2061	3	3	RESISTOR-TRMR 200 10% C TOP-ADJ 1-TRN	73138	82PR200
A9R10	0698-7276	5	2	RESISTOR 46.4K 1% .05W F TC=0+-100	24546	C3-1/8-T0-4642-G
A9R11	0698-7250	5	1	RESISTOR 3.83K 1% .05W F TC=0+-100	24546	C3-1/8-T0-3831-G
A9R12	0698-7269	6	1	RESISTOR 23.7K 1% .05W F TC=0+-100	24546	C3-1/8-T0-2372-G
A9R13	0698-7243	6	1	RESISTOR 1.96K 1% .05W F TC=0+-100	24546	C3-1/8-T0-1961-G
A9R14	2100-2060	2	1	RESISTOR-TRMR 50 20% C TOP-ADJ 1-TRN	73138	82PR50
A9R15	0698-7234	5		RESISTOR 825 1% .05W F TC=0+-100	24546	C3-1/8-T0-825R-G
A9R16	2100-2061	3		RESISTOR-TRMR 200 10% C TOP-ADJ 1-TRN	73138	82PR200
A9R17	0698-7212	9	1	RESISTOR 100 1% .05W F TC=0+-100	24546	C3-1/8-T0-100R-G
A9R18	2100-2061	3		RESISTOR-TRMR 200 10% C TOP-ADJ 1-TRN	73138	82PR200
A9R19	0698-7234	5		RESISTOR 825 1% .05W F TC=0+-100	24546	C3-1/8-T0-825R-G
A9R20	0698-7276	5		RESISTOR 46.4K 1% .05W F TC=0+-100	24546	C3-1/8-T0-4642-G
A9U1	1826-0589	3	1	IC TO-8 PKG	28480	1826-0589
A9U2	1826-0138	8	1	IC COMPARATOR GP QUAD 14-DIP-P PKG	01295	LM339N
A9U3	1820-2171	1	1	IC PRESER ECL	28480	1820-2171

See introduction to this section for ordering information
*Indicates factory selected value

Table 6-2. Replaceable Parts (Continued)

Reference Designation	HP Part Number	C D	Qty	Description	Mfr Code	Mfr Part Number
A9W1	05315-60104	7	1	CABLE ASSEMBLY-FREQ C	28480	05315-60104
				A9 MISCELLANEOUS PARTS		
	0360-0124	3	5	CONNECTOR-SGL CONT PIN .04-IN-RSC-SZ RND	28480	0360-0124
	1205-0375	9	1	HEAT SINK SGL TO-8-CS	05820	211-CB
	05305-60205	7	1	CONNECTOR-SPECIAL BNC	28480	05305-60205
	05305-20104	1	1	CONNECTOR-BODY	28480	05305-20104
	05305-60206	8	1	MINI-CONNECTOR	28480	05305-60206
	05305-20105	1	1	INSULATOR-TEFLON	28480	05305-20105
	0590-0038	5	1	NUT-HEX-DBL-CHAM 1/2-32-THD .094-IN-THK	00000	ORDER BY DESCRIPTION
	1250-0632	6	1	CONNECTOR-RF 5M-SCR M SGL-HOLE-FR	28480	1250-0632
A10				OFFSET NORMALIZER (SEE OPERATING AND SERVICE MANUAL FOR OFFSET/NORMALIZER)		
A11				OFFSET NORMALIZER (SEE OPERATING AND SERVICE MANUAL FOR OFFSET/NORMALIZER)		

See introduction to this section for ordering information
*Indicates factory selected value

Table 6-2. Replaceable Parts (Continued)

Reference Designation	HP Part Number	C D	Qty	Description	Mfr Code	Mfr Part Number
A12	05316-60006	9	1	HP-IB INTERFACE ASSEMBLY (SERIES 1924)	28480	05316-60006
A12C1	0160-4554	7	3	CAPACITOR-FXD .01UF +-20% 50VDC CER	28480	0160-4554
A12C2	0180-0562	1	1	CAPACITOR-FXD 33UF+-20% 10VDC TA	56289	196D336X0010KA1
A12C3	0160-4554	7		CAPACITOR-FXD .01UF +-20% 50VDC CER	28480	0160-4554
A12C4	0160-4554	7		CAPACITOR-FXD .01UF +-20% 50VDC CER	28480	0160-4554
A12J1	1200-0567	1	1	SOCKET-IC 28-CONT DIP DIP-SLDR	28480	1200-0567
A12J2	1251-3283	1	1	CONNECTOR-24-PIN F HP-IB CONN	28480	1251-3283
A12J3	1200-0485	2	1	SOCKET-IC 14-CONT DIP DIP-SLDR	28480	1200-0485
A12R1	1810-0205	7	1	NETWORK-RES 8-SIP4.7K OHM X 7	01121	208A472
A12R2	1810-0136	3	1	NETWORK-RES 10-SIP MULTI-VALUE	28480	1810-0136
A12S1	3101-1973	7	1	SWITCH-SL 7-1A DIP-SLIDE-ASSY .1A 50VDC	28480	3101-1973
A12U1	1820-1144	6	1	IC GATE TTL LS NOR QUAD 2-INP	01295	SN74LS02N
A12U2	1820-2239	2	1	IC MISC 8-BIT	27014	DP8304N
A12U3	1820-1689	4	2	IC UART TTL QUAD	01295	MC3446P
A12U4	1820-1689	4		IC UART TTL QUAD	01295	MC3446P
A12U5	1820-1568	8	1	IC BFR TTL LS BUS QUAD	01295	SN74LS125AN
				A12 MISCELLANEOUS PARTS		
	0380-0643	3	2	STANDOFF-HEX .255-IN-LG 6-32THD	00000	ORDER BY DESCRIPTION
	2190-0017	4	2	WASHER-LK HLCL NO. 8 .168-IN-ID	28480	2190-0017
	1530-1098	4	2	CLEVIS 0.070-IN W SLT: 0.454-IN PIN CTR	00000	ORDER BY DESCRIPTION

See introduction to this section for ordering information
*Indicates factory selected value

Table 6-2. Replaceable Parts (Continued)

Reference Designation	HP Part Number	C D	Qty	Description	Mfr Code	Mfr Part Number
			1	5316A MISCELLANEOUS PARTS		
T1	05316-80001	6	1	TRANSFORMER-MODIFIED NOTE IF T1 IS TO BE REPLACED, ORDER THE COMPLETE MODIFIED TRANSFORMER - 05316-80001	28480	05316-80001
	0362-0063	3	5	CONNECTOR-SGL CONT QDISC-FEM	28480	0362-0063
	0890-0983	5	31	TUBING-HS .125-D/.062-RCVD .02-WALL	28480	0890-0983
	1251-2993	8	1	CONNECTOR 6-PIN F POST TYPE	28480	1251-2993
	1251-3411	7	5	CONTACT-CONN U/W-POST-TYPE FEM CRP	28480	1251-3411
	1400-0249	0	4	CABLE TIE .062-.625-DIA .091-WD NYL	06383	PLT1M-8
	9100-3069	0	1	TRANSFORMER	28480	9100-3069
W1	05316-60101	5	1	A3-A6 INTERCONNECT CABLE	28480	05316-60101
	1251-3963	4	2	KEY-POST CONN	28480	1251-3963
	1251-3967	8	10	CONTACT-CONN U/W-POST-TYPE FEM CRP	28480	1251-3967
	1251-4511	0	2	CONNECTOR 6-PIN F POST TYPE	28480	1251-4511
	1400-0249	0		CABLE TIE .062-.625-DIA .091-WD NYL	06383	PLT1M-8
	8150-0033	6	52	WIRE 22AWG W 300V PVC 7X30 105C	28480	8150-0033
W2	05316-60102	6	2	A/B TRIGGER LEVEL CABLES	28480	05316-60102
	0362-0227	1	1	CONNECTOR-SGL CONT SKT 1.14-MM-BSC-SZ	28480	0362-0227
	0890-0706	0	12	TUBING-HS .093-D/.046-RCVD .02-WALL	28480	0890-0706
	8150-0456	3	21	WIRE 24AWG W 300V PVC 7X34 80C	28480	8150-0456
W3	05316-60102	6		A/B TRIGGER LEVEL CABLES (A3 TO FRONT PANEL)	28480	05316-60102
	0362-0227	1		CONNECTOR-SGL CONT SKT 1.14-MM-BSC-SZ	28480	0362-0227
	0890-0706	0		TUBING-HS .093-D/.046-RCVD .02-WALL	28480	0890-0706
	8150-0456	3		WIRE 24AWG W 300V PVC 7X34 80C	28480	8150-0456
W4	8120-1378	1	1	POWER CORD - U.S.A.	28480	8120-1378
W5	8120-2969			28-CONDUCTOR RIBBON CABLE (A1-A12 INTERCONNECT)	28480	8120-2969

See introduction to this section for ordering information
*Indicates factory selected value

Table 6-3. Mechanical Parts List

Reference Designation	HP Part Number	C D	Qty	Description	Mfr Code	Mfr Part Number
5316A MECHANICAL PARTS LIST						
MP1	05316-00001	8	1	FRONT PANEL (STD. INSTRUMENT)	28480	05316-00001
MP2	05316-00005	2	1	FRONT PANEL (OPTION 003)	28480	05316-00005
MP3	5020-8813	8	1	FRONT FRAME	28480	5020-8813
MP4	05316-00002	9	1	REAR PANEL	28480	05316-00002
MP5	5020-8814	9	1	REAR FRAME	28480	5020-8814
MP6	5020-8831	0	1	STRUT-RIGHT-UNDRILLED SIDE	28480	5020-8831
MP7	5020-8886	5	1	STRUT-LEFT-DRILLED SIDE	28480	5020-8886
MP8	5001-0419	4	1	COVER-TOP	28480	5001-0419
MP9	5060-9964	6	1	COVER-BOTTOM	28480	5060-9964
MP10	5060-9803	2	1	HANDLE-STRAP	28480	5060-9803
MP11	5040-7219	8	1	STRAP-FRONT CAP	28480	5040-7219
MP12	5040-7220	1	1	STRAP-REAR CAP	28480	5040-7220
MP13	5040-7201	8	4	FOOT (STANDARD)	28480	5040-7201
MP14	1460-1345	5	1	TILT STAND SST	28480	1460-1345
MP15	5040-7203	0	1	TRIM STRIP-TOP	28480	5040-7203
MP16	5001-0438	7	2	SIDE TRIM	28480	5001-0438
MP17	05316-40001	2	1	DISPLAY WINDOW	28480	05316-40001
MP18	7120-8571	9	1	LABEL-INFO, BOTTOM	28480	7120-8571
MP19	0403-0373	6	4	A1 SLIDE RAILS	28480	0403-0373
MP20	0510-1152	4	8	RETAINER-PUSH ON CIRC EXT .156-IN-DIA	28480	0510-1152
MP21	0370-2486	5	7	PUSHBUTTON FUNCTION	28480	0370-2486
MP22	0370-2917	7	1	BUTTON-BLUE SHIFT	28480	0370-2917
MP23	0370-2625	4	1	BUTTON-WHITE STANDBY	28480	0370-2625
MP24	0370-0914	0	9	BEZEL FOR FUNCTION BUTTONS	28480	0370-0914
MP25	5040-8816	3	10	INPUT AMPLIFIER BUTTONS	28480	5040-8816
MP26	0370-0606	7	10	BEZEL FOR INPUT SWITCHES	28480	0370-0606
MP27	0370-1005	2	3	KNOB-BASE-PTR 3/8 JGK .125-IN-ID	28480	0370-1005
MP28	05316-00003	0	1	HEAT SINK-SUPPORT BRACKET	28480	05316-00003
MP29	05316-00004	1	1	BRACKET-TRANSFORMER	28480	05316-00004

See introduction to this section for ordering information
*Indicates factory selected value

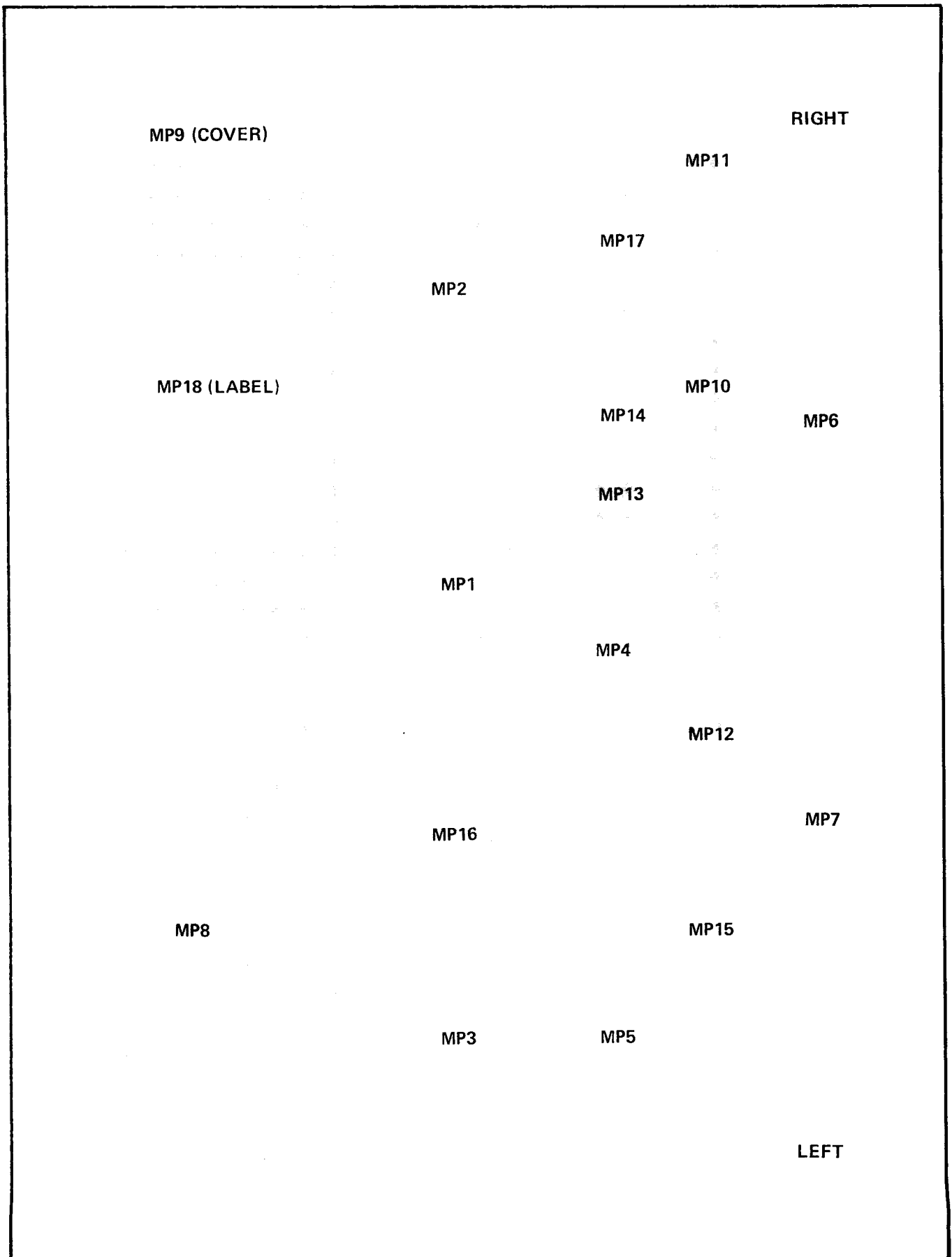

Figure 6-1. Model 5316A Mechanical Parts Layout

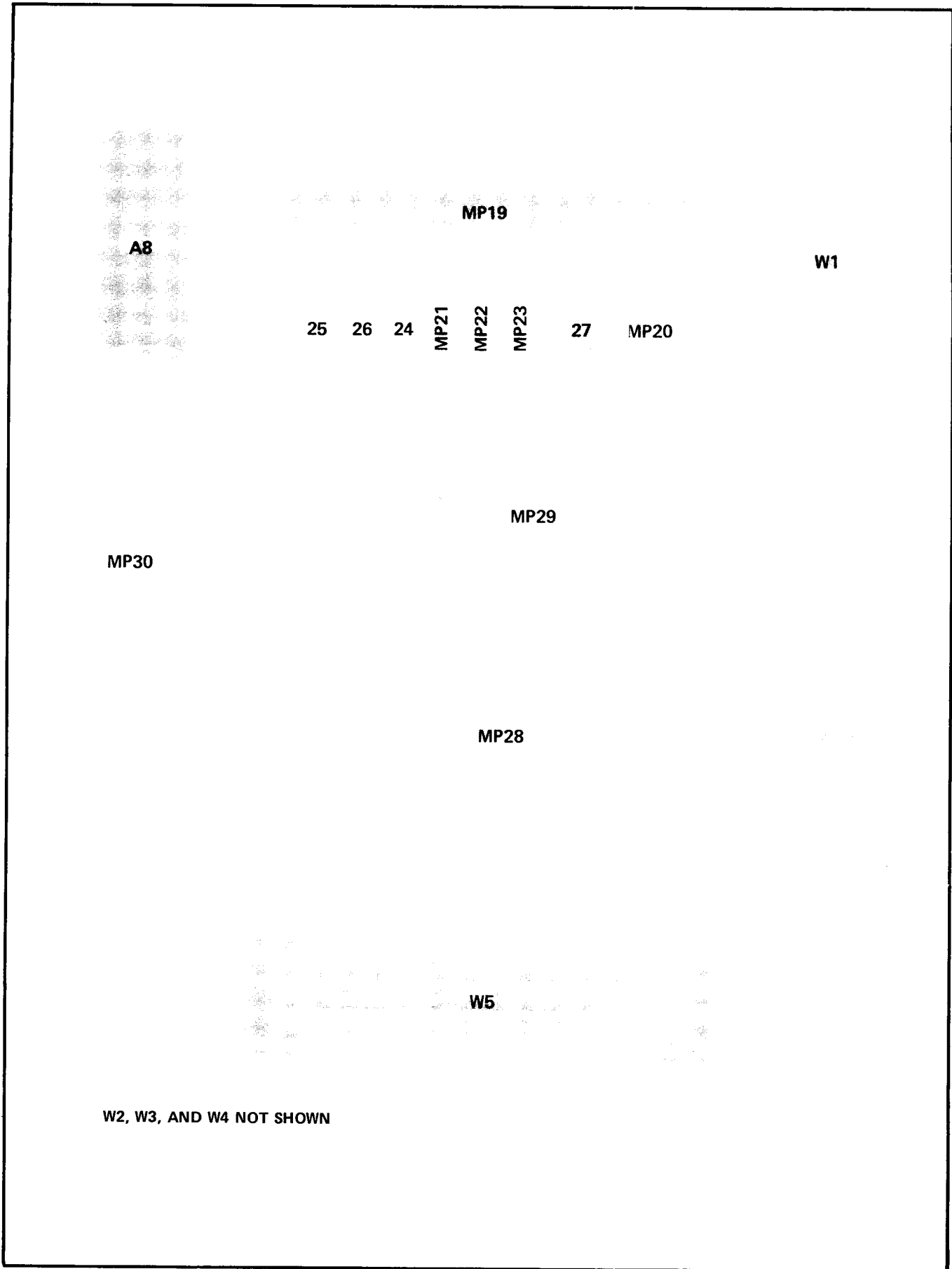

Figure 6-2. Model 5316A Mechanical Parts Layout

Table 6-4. 5316A Hardware

DESCRIPTION	QTY.	HP PART NO.
Screws securing side struts to Front/Rear Frame 8-32 × .250" Flat Head 100°	8	2510-0192
Screw for Rear Strap Handle — 10-32 × .375" Flat Head 100°	1	2680-0172
Screw securing Center of A12 to Standoff on A1 6-32 × .250" Pan Head Pozidriv	1	2360-0331
Screws securing HP-IB Connector to the Rear Panel — Special	2	0380-0644
Screw in Bottom Cover — 6-32 × .460" — Special	1	0570-1171
Retainer for above — .41" Inside Dia. Stl. CD-PL	1	0510-0043
Screws securing Rear Panel to Rear Frame 6-32 × .188" Pan Head Pozidriv	4	2360-0330
Screws securing Front Panel to Front Frame 6-32 × .188" Flat Head 100°	6	2360-0190
Nut securing Front Panel to A2 — 4-40 W/Lkwr. .094" Thk.	1	2260-0009
Nuts for Channel A and B BNCs — Dbl. Cham. 15/32-32-Thd.	2	2950-0035
Lockwashers for above — Lockwasher Int. 3/8" × .377" ID	2	2190-0016
Nut for REF IN/OUT BNC — 1/2 32 Thd .094" Thk	1	0590-0038
Lockwasher for above — .5" Intl. .505"-ID	1	2190-0068
Screw securing A1 to Rear Panel 6-32 × .188" Pan Head Pozidriv	1	2360-0330
Screws securing A7 to A1 — 4-40 × .250" Pan Head Pozidriv W/Lock	2	2200-0103
Screws securing A6 to Side Frame — 4-40 × .312" Pan Head Pozidriv W/Lock	1	2200-0105
Screws securing Heat Sink to A1 — 6-32 × .250" Pan Head Pozidriv	2	2360-0113
Screws securing Heat Sink to Side Frame — 6-32 × .312" Pan Head Pozidriv	2	2360-0115
Screws securing T1 to Bracket — 6-32 × .312" Pan Head Pozidriv	2	2360-0115
Screws securing T1 Bracket to Side Frame 6-32 × .250" Pan Head Pozidriv	5	2360-0113
Screws securing Oscillator Mounting Bracket to A13 Oven Oscillator (Option 004) 4-40 × .187"	3	2200-0101
Screws securing Oscillator Mounting Bracket to left side frame	3	2360-0113
Screws securing A4 to A1 — 6-32 × .250" Pan Head Pozidriv	4	2360-0113
Screws securing A9 to A1 — 6-32 × .250" Pan Head Pozidriv	4	2360-0113
Set Screws for Knobs — 4-40 .125" Flat Pt. Aly	6	3030-0014
Screws for Regulator Transistors — 4-40 × .250" Pan Head Pozidriv	3	2200-0139
Insulators for Regulators Transistors	3	0340-0864
Insulating Washers for Regulator Transistors — Nylon	3	3050-0791
Nuts for Trigger Pots Hex — 1/4 4-40 Thd .062" Thk	2	2950-0052
Standoffs for Trigger Pots — Special	2	05315-20201
Tie Wraps	4	1400-0249
Replacement Screws for REF IN/OUT BNC 4-40 .5" Pan Head Pozidriv	2	2200-0111
Nuts for above	2	2260-0003
Elastic Washers for above Flat Washer MTLC No. 4 .125" ID	2	3050-0105

Table 6-5. Manufacturers Code List

MFR. NO	MANUFACTURER NAME	ADDRESS	ZIP CODE
D2540	VALVO GMBH, HAMBURG, GERMANY		
00000	ANY SATISFACTORY SUPPLIR		
01121	ALLEN-BRADLEY COMPANY, MILWAUKEE, WI		53204
01295	TEXAS INSTR., INC., SEMICOND. CMPNT DIV., DALLAS, TX		75222
0192B	RCA CORP., SOLDI STATE DIV., SOMERVILLE, NJ		08876
02114	FERROXCUBE CORP., SAUGERTIES, NY		12477
03508	GE CO., SEMICONDUCTOR PROD. DEPT., SYRACUSE, NY		13201
03888	KDI PYROFILM CORP., WHIPPANY, NJ		07981
04713	MOTOROLA SEMICONDUCTOR PRODUCTS, PHOENIX, AZ		85062
05820	WAKEFIELD ENGINEERING INC., WAKEFIELD, MA		01880
06383	PANDUIT CORP., TINLEY PARK, IL		60477
07263	FAIRCHILD SEMICONDUCTOR DIV., MOUNTAIN VIEW, CA		94042
11236	CTS OF BERNE INC., BERNE, IN		46711
16299	CORNING GL. WK. ELEC. CMPNT. DIV., RALEIGH, NC		27604
19701	MEPCO/ELECTRA CORP., MINERAL WELLS, TX		76067
24335	ANALOG DEVICES INC., NORWOOD, MA		02062
24546	CORNING GLASS WORKS (BRADFORD), BRADFORD, PA		16701
25088	SIEMENS CORP., ISELIN, NJ		08830
27014	NATIONAL SEMICONDUCTOR CORP., SANTA CLARA, CA		95051
28480	HEWLETT-PACKARD CO., CORPORATE HQ., PALO ALTO, CA		94304
32293	INTERSIL INC., CUPERTINO, CA		95014
34335	ADVANCED MICRO DEVICES INC., SUNNYVALE, CA		94086
50522	MONSANTO CO ELEK SPECIAL PROD., CUPERTINO, CA		94304
51642	CENTRE ENGINEERING INC., STATE COLLEGE, PA		16801
52763	STETTNER-TRUSH INC., CAZENOVIA, NY		13035
56289	SPRAGUE ELECTRIC CO., NORTH ADAMS, MA		01247
72136	ELECTRO MOTIVE CORP., SUB. IEC, WILLIMANTIC, CT		06226
73138	BECKMAN INSTRUMENTS INC., HELIPOT DIV., FULLERTON, CA		92634

SECTION VII MANUAL CHANGES

7-1. INTRODUCTION

7-2. This section contains information necessary to adapt this manual to older instruments.

7-3. MANUAL CHANGES

7-4. This manual applies directly to Model 5316A having Serial Prefix 2120A.

7-5. NEWER INSTRUMENTS

7-6. As changes are made, newer instruments may have serial prefix not listed in this manual. Manuals for these instruments are supplied with a manual change sheet, containing the required information. Contact the nearest Hewlett-Packard Sales and Service Office for information if this sheet is missing.

7-7. OLDER INSTRUMENTS

7-8. To adapt this manual to instruments having a serial prefix prior to 2120A, perform the backdating that applies to your instrument's serial prefix as listed in *Table 7-1* below.

Table 7-1. Manual Backdating

If Instrument has Serial Prefix	Make the Following Changes to Manual
2052A or 2004A	1
1924A	2

CHANGE 1 (2052A or 2004A)

Page 6-5, Table 6-1, Replaceable Parts List (A1 Motherboard):

Change SERIES number to 2004A.

Add A1C21, 0160-4554; CAPACITOR-FXD .01UF \pm 20% 50VDC CER; 28480; 0160-4554.

Delete CR14.

Page 8-29, Figure 8-5, A1 Motherboard Schematic Diagram (Sheet 1 of 2):

Change SERIES to 2004A.

Remove the connection between U13B pin 11 and the negative side of C39 (3900 μ F).

Connect U13B pin 11 to the junction of R29 (9.09K) and the emitter of Q10.

CHANGE 2 (1924A)

Page 6-6, Table 6-1, Replaceable Parts List (A1 Motherboard):

Change SERIES number to 1924.

Delete A1R46, 196-ohm Resistor.

Page 8-29, Figure 8-5, Schematic Diagram (A1 Motherboard) (Sheet 1 of 2):

Change SERIES number to 1924.

Delete A1R46, 196-ohm Resistor in series with A1U2 (MRC) pin 21 external reference.

Page 6-13, Table 6-1, A7 TCXO (Option 001 A7 Assembly):

Change A7R1 to 316 ohm 0698-3444

Change A7R2 to 1K 0757-0280.

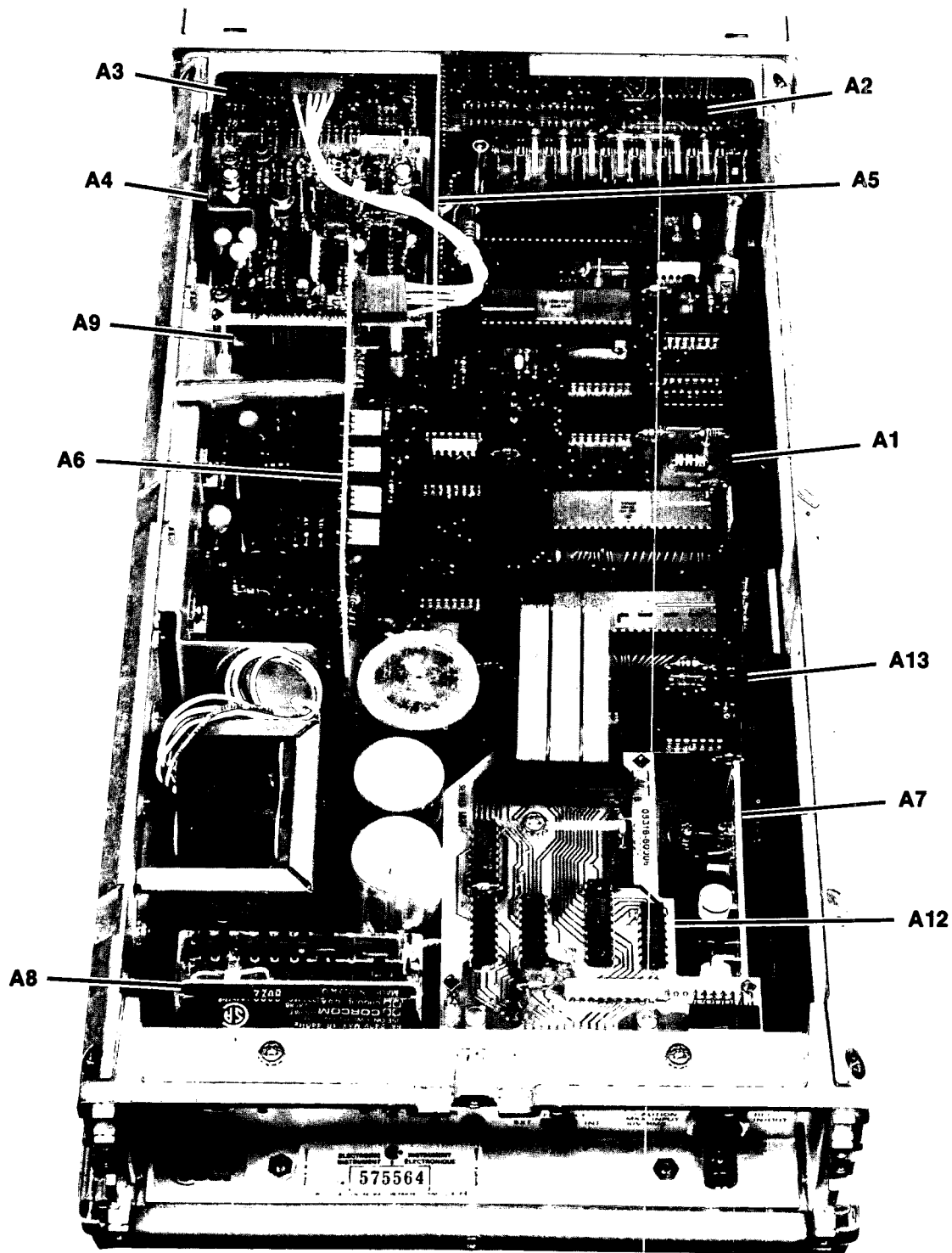

A10 & A11 P/O OPTION 006 NOT SHOWN

SECTION VIII SERVICE

WARNING

IF THE A8 POWER MODULE COVER IS REMOVED, LINE VOLTAGE IS EXPOSED WITHIN THE 5316A EVEN WHEN THE POWER SWITCH IS IN THE STBY POSITION.

8-1. INTRODUCTION

8-2. This section contains the information required to service the 5316A Universal Counter. The information includes theory of operation, troubleshooting, safety considerations, service aids, block diagram, and schematic diagrams. This section also includes a cross-reference table, *Table 8-1*, to aid the correlation of assembly reference designations with their HP part numbers.

8-3. THEORY OF OPERATION

8-4. The overall theory of operation begins with paragraph 8-28 and references the overall block diagram, *Figure 8-2*. The detailed theory of operation for each assembly is located adjacent to the schematic diagram for that particular assembly.

8-5. TROUBLESHOOTING

8-6. Troubleshooting for the 5316A is performed by isolating the defective block as described in troubleshooting, paragraph 8-40, and then referring to that particular schematic. Each schematic section contains the detailed theory of operation, detailed troubleshooting information, schematic diagram, and repair considerations.

8-7. The schematic diagrams for all the assemblies are located at the end of this section.

8-8. RECOMMENDED TEST EQUIPMENT

8-9. The test equipment required to service the 5316A is listed in *Table 1-4*. Equipment other than that listed may be substituted if it meets or exceeds the critical specifications.

8-10. SCHEMATIC DIAGRAM NOTES

8-11. *Figure 8-1* shows the symbols used on the schematic diagrams. *Figure 8-1* also shows the method of assigning reference designators, assembly numbers, and subassembly numbers. The 5316A contains two subassemblies, A3 05316-60003, and A4 05315-60004 that are combined to form the 05316-60100 A3/A4 Input Amplifier assembly.

8-12. Reference Designations

8-13. Assemblies such as printed circuit boards are assigned numbers in sequence, A1, A2, etc., as shown in *Table 8-1*. Reference designators for individual components are determined by adding the assembly number with the component number. For example, CR1 on assembly A1 is designated A1CR1.

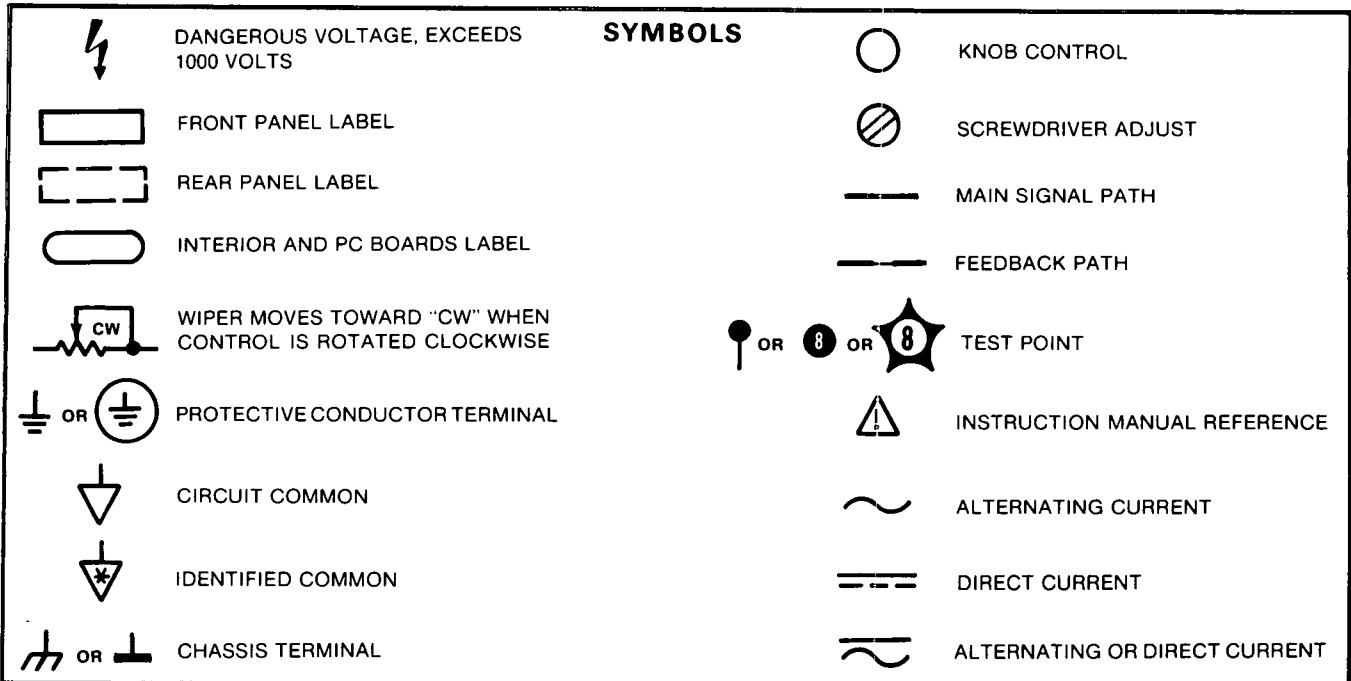

PRINTED CIRCUIT BOARD IDENTIFICATION

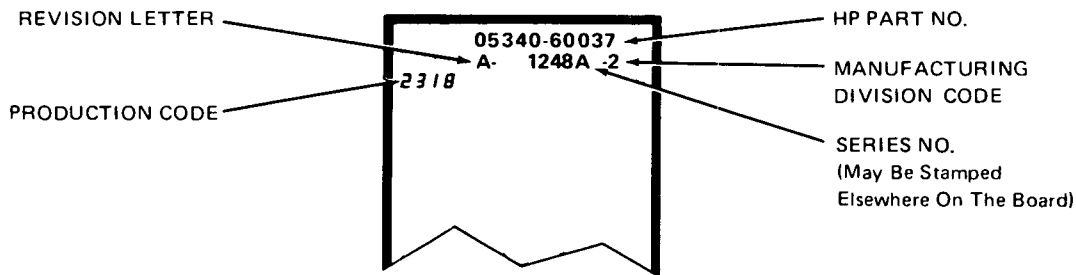

REFERENCE DESIGNATIONS

REFERENCE DESIGNATIONS WITHIN ASSEMBLIES ARE ABBREVIATED. ADD ASSEMBLY NUMBER TO ABBREVIATION FOR COMPLETE DESCRIPTION. JACKS ARE THE STATIONARY CONNECTORS AND PLUGS ARE THE MORE MOVEABLE OF TWO CONNECTORS.

ASSEMBLY	ABBREVIATION	COMPLETE DESCRIPTION
A25	C1	A25C1
A25A1	CR1	A25A1CR1
NO PREFIX	J3	J3

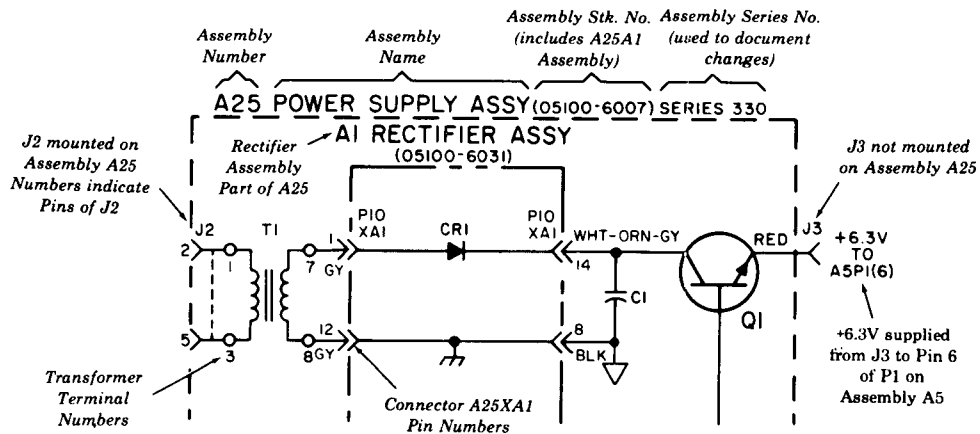

Figure 8-1. Schematic Diagrams Notes

8-14. Identification Markings on Printed Circuit Boards

8-15. HP printed circuit boards (see *Figure 8-1*) have four identification numbers; an assembly number, a series number, a revision letter, and a production code. The assembly part number has 10 digits, such as 05316-60001, and is the primary identification. All assemblies with the same part number are interchangeable. When a production change is made to an assembly that makes it incompatible with the previous assembly, the part number is changed. The series number, such as 2120, is used to document minor electrical changes. As changes are made, the series number is incremented. When replacement assemblies are ordered, you may receive a replacement with a different series number. If a difference is found between the series number marked on the assembly and the number on the schematic, then minor electrical difference exist. If the series number on the assembly is lower than that on the schematic, then refer to Section VII, Manual Changes. Section VII contains documentation of the lower series assemblies. If the number is higher, then refer to the yellow looseleaf manual change sheets for this manual. If the manual change sheets are missing, contact your local HP Sales and Service Office. See the listings at the back of this manual.

8-16. Revision letters (A, B, etc.) denote changes in the printed circuit layout. For example, if a capacitor type is changed (the electrical value may remain the same) and requires different lead spacing, then the layout is changed and the revision letter is incremented. When the revision letter changes, then the series number usually changes. The production code is the seven-segment number used for production purposes.

8-17. SAFETY CONSIDERATIONS

8-18. Although the 5316A has been designed in accordance with international safety standards, this manual contains information, cautions, and warnings which must be followed to insure safe operation (also see Sections II, III, and V). Service and adjustments should be performed only by qualified personnel.

WARNING

ANY INTERRUPTION OF THE PROTECTIVE (GROUNDING) CONDUCTOR (INSIDE OR OUTSIDE THE 5316A) OR DISCONNECTION OF THE PROTECTIVE EARTH TERMINAL IS LIKELY TO MAKE THE 5316A DANGEROUS.

8-19. Opening the 5316A while power is connected should be avoided as much as possible, and when necessary, should be carried out only by a skilled person who is aware of the hazards involved. Capacitors inside the 5316A may still be charged even if the 5316A has been disconnected from its source of power.

WARNING

LINE VOLTAGE IS EXPOSED AT THE 5316A POWER MODULE EVEN WHEN THE POWER SWITCH IS IN STBY. REMOVAL OF THE POWER CORD IS NECESSARY TO REMOVE THE LINE VOLTAGE FROM THE 5316A.

8-20. Make sure that only fuses with the required rated current and of the type specified (.15 or .30 AMP SLO-BLO) are used for replacement. The use of repaired fuses or short circuiting of fuseholders **MUST** be avoided. Whenever it is likely that the protection has been impaired, the 5316A must be rendered inoperative and secured against any operation until repaired.

8-21. The following safety symbols are used on equipment and in manuals:



Instruction manual symbol. The product will be marked with this symbol when it is necessary for the user to refer to the instruction manual in order to protect against damage to the instrument.



Indicates dangerous voltage (terminals feed from the interior by voltage exceeding 1000 volts must be so marked).

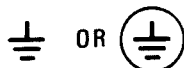

Protective conductor terminal. For protection against electrical shock in case of a fault. Used with field wiring terminals to indicate the terminal which must be connected to ground before operating equipment.



Low-noise or noiseless, clean ground (earth) terminal. Used for a signal common, as well as providing protection against electrical shock in case of a fault. A terminal marked with the symbol must be connected to ground in the manner described in the installation (operating) manual, and before operating the equipment.

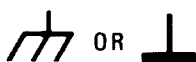

Frame and chassis terminal. A connection to the frame (chassis) of the equipment which normally includes all exposed metal structures.



Alternating current (power line).



Direct current (power line).



Alternating or direct current (power line).



The **WARNING** signal denotes a hazard. It calls attention to a procedure, practice, or the like, which, if not correctly performed or adhered to, could result in personal injury.



The **CAUTION** sign denotes a hazard. It calls attention to an operating procedure, practice, or the like, which, if not correctly performed or adhered to, could result in damage to or destruction of part or all of the product.

8-22. SERVICE AIDS

8-23. Pozidriv Screwdrivers

8-24. The screws in the 5316A which appear to be Phillips type are not. They are Pozidriv. Although the two types are similar, damage to the screw or screwdriver will result if the correct driver is not used. Phillips screwdrivers will not seat into the Pozidriv screw-head properly. So Pozidriv screwdrivers must be used.

8-25. Service Aids on Printed Circuit Boards

8-26. The servicing aids include test points, transistor and integrated circuit designations, adjustment callouts, and assembly stock numbers.

8-27. The assembly number, name, and Hewlett-Packard part number of the 5316A assemblies are listed in *Table 8-1*.

Table 8-1. 5316A Assembly Reference Designators

REFERENCE DESIGNATION	DESCRIPTION	HP PART NUMBER
A1	Motherboard/Power Supply	05316-60001
A2	Display Assembly	05315-60012
A3	*Input Switches	05316-60003
A4	*Input A&B Amplifiers	05315-60004
A5	Display Support	05315-60005
A6	D-to-A Converter	05316-60010
A7	Standard Oscillator	05316-60008
A7	TCXO 001	05316-60007
A7	Regulator Assembly 004	05316-60013
A8	Power Module	0960-0444
A9	Channel C Input 003	05315-60009
A10	**Offset/Normalizer 006	05315-60010
A11	**Offset/Normalizer 006	05315-60011
A12	HP-IB Interface	05316-60006
A13	Oven Oscillator 004	0960-0603

*If A3 or A4 are to be replaced, both assemblies must be ordered as a pair under Part Number 05316-60100.
 **A10 and A11 are the assemblies in the Option 006 Offset/Normalizer Module (not discussed in this manual).
 Part Numbers are for reference only.

8-28. THEORY OF OPERATION

8-29. Signal Mnemonics

8-30. Table 8-2 lists the signal mnemonics used in the 5316A for the primary control lines.

8-31. Introduction

8-32. The 5316A is a Universal Counter with frequency, period, time interval, time interval average, ratio, and totalizing capabilities. The 5316A utilizes five LSI circuits. A 3870 Microcomputer (A1U1) controls a Multiple-Register-Counter (MRC A1U2) to form the basic counter system. A 6801 Microcomputer (A1U10) controls a 68488 HP-IB Interface (A1U12) to handle all bus operations. The 6801 (A1U10) exchanges data with the 3870 (A1U1). In addition, a Display Decoder/Driver (A2U3) formats that display data for the eight 7-segment LEDs. The following paragraphs describe the overall functional operation and reference Figure 8-2, Overall Block Diagram. The detailed theory of operation is located adjacent to the corresponding schematic diagrams.

8-33. Block Theory

8-34. The 5316A is divided into the following assemblies (listed in relative order of signal flow):

1. A3 Input Switch Assembly.
2. A4 Input Amplifier Assembly.
3. A9 Channel C Assembly (Option 003).
4. A1 Motherboard Assembly.
5. A5 Display Support Assembly.
6. A2 Display Assembly.
7. A7 Time Base Assembly.
 - a. Standard Time Base Oscillator.
 - b. TCXO (Option 001).
 - c. A7 and A13 Oven Oscillator (Option 004).

8. A6 Digital-to-Analog Converter (Remote Trigger Levels).
9. A12 HP-IB Interface Assembly.
10. A8 AC Line Input Module.
11. A10/A11 Offset Normalizer Assembly (Option 006).

NOTE

In the following theory, four LSI integrated circuits will be referred to as follows:

Counter Microcomputer (A1U1)	3870
Multiple Register Counter (A1U2)	MRC
HP-IB Microcomputer (A1U10)	6801
HP-IB Interface Adapter (A1U12)	68488

8-35. Overall Theory

8-36. There are two essentially identical input channels, which condition and shape the input signals. Front panel controls allow individual selection of AC/DC coupling, Attenuation (X1/X20), Trigger Slope, and Separate/Common A signal source selection. The input amplifier assembly buffers and shapes the signals, and sets the desired trigger level or sensitivity. The signals are then level-shifted and sent to the MRC (A1U2) as Channel A and Channel B. An arming signal is also generated from Channel B (used only in A armed by B). The MRC receives the input signals from Channel A, B, and sometimes B Arming, and the Reference Oscillator (A7). Under control of the 3870 (U1), it processes the data for the function specified by the function switches.

In addition to the Channel A and B input, Option 003 Channel C (A9) allows frequency measurements up to 1 GHz. For increased measurement accuracy, a Temperature Compensated Crystal Oscillator (Option 001 TCXO), or Oven Oscillator (Option 004) may be used in place of the standard reference oscillator (A7). When using an external time base as the reference, an injection-locked multiplier located on the A1 Motherboard detects the presence of an external input and buffers the incoming external signal (1, 5, or 10 MHz) and multiplies it, if necessary, up to the 10 MHz reference frequency.

8.37. To make measurements, a 3870 routinely scans and stores the position of the Function Switches, S1-3 through S1-9, and then configures the MRC, via the Address Command bus to the desired measurement mode (frequency, period, time interval, totalize, etc.). The 3870 then “arms” the MRC, which allows the measurement to begin. The input signal to the MRC starts the measurement, and when the Gate Time One-Shot times out, the MRC signals the 3870 microcomputer (via its IRQ) that the measurement is complete. The 3870 will then read the measurement data from the MRC, manipulate it mathematically and direct it to the Display Driver (A2U3). The Display Driver receives, decodes, and displays the data. The exponent, exponent sign, units annunciator, and decimal point are computed within the 3870 at the same time as the measurement data. The 3870 will then repeat the cycle, until the Function switches are changed, at which time it will reconfigure the MRC.

8-38. The power supply provides four dc voltages to the 5316A circuitry: +5V, +3V, -5.2V, and a 2.5V reference. The A8 Power Module contains a pc card that, depending on its orientation, determines the line voltage to be used by configuring the primary windings of T1 as necessary (see paragraph 2-8). The secondary of T1 is then routed to the A1 Motherboard which contains the rectifiers and regulators.

8-39. For remote control via the HP-IB a 6801 Microcomputer (A1U10) and 68488 HP-IB Interface Adapter (A1U12) are located on the A1 Motherboard. The 6801 can communicate with the 3870 and the MRC (via the 3870). The 6801 always controls power-up reset, and selection of Time Interval Delay and Channel C functions. The HP-IB Interface assembly (A12) contains the bus transceivers, address selection switches, and buffers. The A12 assembly interfaces directly to the 68488 HP-IB Interface Adapter. A Digital-to-Analog Converter (A6) is available for remote programming of the Channel A and B trigger levels.

Table 8-2. Mnemonics

MNEMONIC	DESCRIPTION	FROM	TO
a-d	Data lines for exponent digit to the display	A1U1(30-33)	A2U2(7,1,2,6)
ADDRESSED	Lights ADRSD LED. The 5316A has been addressed via the HP-IB	A1U10(18)	A2DS14
ATN	HP-IB Attention	A12J2(11)	A1U12(26)
\overline{ASE}	Address Switch Enable	A1U12(4)	A1U14(1,3)
$\overline{A1-A5}$	Address switch data lines	A12S1(1-5)	A1U12(7-11)
A/\overline{TO}	Addressable/ $\overline{\text{Talk Only}}$ to 68488	A12S1(7)	A1U12(13)
CHAN A LOW FREQ	Low frequency path for Channel A amplifier		
CHAN A HIGH FREQ	High frequency path for Channel A amplifier		
CHAN A TO MRC	Channel A signal to MRC	A4U1(11)	A1U2(30)
CHAN B TO MRC	Channel B signal to MRC	A4U1(2)	A1U2(28)
CHANNEL B ARM	Channel B external arm to MRC	A4U1(2)	A1U2(17)
CE1	Enables display for update	A1U1(19)	A2U3(9)
CE2	Measurement gating signal from 3870 to Channel C	A1U1(18)	A9U2(4)
CE2	Enables Offset/Normalizer data to be placed on the 3870 data bus		A10U13(2,10)
CE3	Enables Offset/Normalizer data to be placed on the 3870 data bus	A1U1(17)	A1U3(12), U5(14) A11U13(4,5)
CH A	MRC Channel A Input		A1U2(30)
CH B	MRC Channel B Input		A1U2(28)
CH C	MRC Channel C Input		A1U2(26)
CHANNEL C GAIN	Gain control for Channel C	A4R2 WIPER	A9Q3(GATE)
CONTROL VOLTAGE	Sensitivity control voltage to Channel C		
$\overline{\text{CHAN C SWITCH}}$	Front panel function switch logic level to 6801 to select Channel C	A1S1-S7	A1U10(11)
$\overline{\text{CLEAR 3870 I/O}}$	End of a 3870-6801 interaction	A1U11(7)	A1U3(8), U4(6)
ΔCE	CE line-previous state changed	A1U4(9)	A1U6(14)
DATA 0-7	Port 3 of 6801 (data bus)	A1U10(30-37) A1U5(3,5,7,9,11,13)	A1U12(7-14)
D0-D3	Data lines for display (mantissa)	A1U1(12-15)	A2U3(5,6,10-14)
D0-D3	Data lines between 3870 and 6801	A1U6(3,5,7,9)	A1U2(32-35)
D0-D3			A1U5(2,4,6,10)
DP	Decimal point position for the display	A1U1(11)	A2U3(7)
DAC A SIGN	Select trigger level polarity for DAC A (Channel A)	A1U8(10)	A6U4(10)
DAC B SIGN	Select trigger level polarity for DAC B (Channel B)	A1U8(7)	A6U4(9)
DAC A NEW DATA 	Enables DAC A for new data	A1U11(12)	A6U1(13)

Table 8-2. Mnemonics (Continued)

MNEMONIC	DESCRIPTION	FROM	TO
DAC B NEW DATA 	Enables DAC B for new data	A1U11(13)	A6U3(13)
DAC	HP-IB Data Accepted	A12J2(8)	A1U12(17)
DAV	HP-IB Data Valid	A12J2(6)	A1U12(16)
EOI	HP-IB End or Identify	A12J2(5)	A1U12(25)
FPGT	Front panel control for gate time	A1R1 WIPER	A1U7(1)
GATE	Lights Gate LED; MRC is gating	A1U1(26)	A2U1(1,3,)
GATE TIME	Line from analog switch to MRC from gate time control	A1U7(15)	A1U2(6)
GATE TIME LOCAL/ $\overline{\text{PRESET}}$	From U8; selects front or rear panel gate time control	A1U8(5)	A1U7(10)
GAIN	Channel C sensitivity control		
IFC	HP-IB Interface Clear	A12J2(9)	A1U12(21)
IRQ	Interrupt request from MRC	A1U10(5)	A1U12(40)
IB0-7	HP-IB DIO lines (after transceivers)	A12U2(1-8)	A1U12(29-36)
Hz	Lights Hertz LED; measurement is a frequency	A1U1(27)	A2U1(9)
$\overline{\text{IOS}}$	6801 I/O strobe; a Read or Write involving data transfer by the 6801, from or to an external circuit	A1U10(39)	A1U1(5)
LATCH MISC FUNCTIONS	Latches data from port 1 of the 6801 at U8	A1U11(10)	A1U8(9)
$\overline{\text{MRC GO}}$	MRC Gate Open (not used)	A1U2(15)	
$\overline{\text{MRC ESR}}$	External Sequencer Reset (not used)	A1U2(27)	
Minus (-)	Lights "minus" sign	A1U1(29)	A2U1(11,13)
MULTIPLIER TURNOFF	Disables the Injection-Locked Multiplier when no external reference is present	A1Q11(C)	A1U16(5)
NS0-NS2	Nibble select lines to MRC	A1U1(8,9,10)	A1U2(9,10,11) A11U1(21,22,23)
$\overline{\text{POWER-UP RESET}}$	Hardware Reset during power-up initialization	A1U15(8)	A1U10(6), A1U12(19), A1U1(39)
$\overline{\text{REMOTE/LOCAL}}$	Lights "REMOTE" LED; 5316A is under remote (HP-IB) control from 6801	A1U10(17)	A2DS15
$\overline{\text{RESET COUNTER}}$	Front panel reset has been implemented; 6801 Resets the 3870	A1U10(20)	A1U1(38) A1U4(11)
RPGT	Rear panel control for gate time	A1R44	A1U7(2)
R/ $\overline{\text{W}}$	Read/ $\overline{\text{Write}}$ to MRC registers	A1U1(5)	A1U2(40)
RG0-RG1	Register select lines to/from MRC	A1U1(3,4)	A1U2(1,2)
RST	Reset counters		
R/ $\overline{\text{W}}$	6801 Read/Write	A1U10(38)	A1U12(5)
RFD	HP-IB Ready for Data	A12J2(7)	A1U12(18)
REN	HP-IB Remote Enable	A12J2(17)	A1U12(22)
REF VOLTAGE	+2.5V dc voltage reference line	A1U9(2)	A1U13(3,10), A1R19, A6U1(15), U3(15)

Table 8-2. Mnemonics (Continued)

MNEMONIC	DESCRIPTION	FROM	TO
REF OSC	10 MHz clock to the MRC	A1S10	A1U2(21)
SEC	Lights Seconds LED	A1U1(28)	A2U1(5)
\overline{STR}	Indicates an address or command is valid	A1U1(7)	A1U2(8), A1U4(3), A2U3(8)
SLOPE A	Channel A Slope line to 3870	A3S2	A1U1(34)
SLOPE B	Channel B Slope line to 3870	A3S9	A1U1(35)
SENSITIVITY A	Channel A Sensitivity control voltage	A3S4	A4U2(4)
SENSITIVITY B	Channel B Sensitivity control voltage	A3S6	A4U2(13)
$\overline{SELECT\ C\ CHANNEL}$	From 6801 to control the position of relay K1	A1U8(12)	A1Q8(B)
SRQ	HP-IB Service Request	A12J2(10)	A1U12(23)
TRIGGER LIGHT SUPPLY	Isolated +5V for trigger LEDs		
TRIGGER LIGHT A&B	Lights Channel A&B trigger lights	A4U3(1,8)	A3DS1,2
T.I. DELAY	From front panel to 6801 shortens gate time; removes C13 at U7	A1S1-S5	A1U10(9)
TRIGGER LEVEL POT/ $\overline{DAC5}$	Selects local/ \overline{remote} triggers levels	A1U8(2)	A6U5(9,10)
TRIGGER LEVEL POT A	Voltage from the wiper of the Channel A trigger level control	A3S4	A6U5(1)
TRIGGER LEVEL POT B	Voltage from the wiper of the Channel B trigger level control	A3S6	A6U5(3)
TRIGGER LEVEL A	Channel A trigger level control voltage	A6U6(1)	A4U2(8)
TRIGGER LEVEL B	Channel B trigger level control voltage	A6U6(7)	A4U2(9)
$T/\overline{R1}$	Transmit/ $\overline{Receive}$ control for HP-IB	A1U12(28)	A12U5(13)
$T/\overline{R2}$	Transmit/ $\overline{Receive}$ control for HP-IB	A1U12(27)	A12U2(11), A12U5(1,4) A12U4(4)
$\overline{T/R2}$	Complement of $T/\overline{R2}$	A1U15(6)	A12U3(4), U5(10)
$\overline{TALK\ ONLY}$	From A12 to 68488 for talk only	A12S1-1	A1U14(14)
33 μ F IN/ \overline{OUT}	Removes A1C13 to enable shorter gate times	A1U8(15)	A1U7(9)
$\overline{3870\ DATA\ IN}$	Enables 3870 data onto the 6801 data bus	A1U11(9)	A1U5(1,15), A1U6(15)
-5.2 UNSWITCHED	-5.2V dc line to input amplifiers. Not controlled by relay K1	A1Q10(C)	
+7.5 UNREGULATED	Unregulated dc from transformer T1 secondary and rectifiers		
-7.5 UNREGULATED	Unregulated dc from transformer T1 secondary and rectifiers		
+4 UNREGULATED	Unregulated dc from transformer T1 secondary and rectifiers		

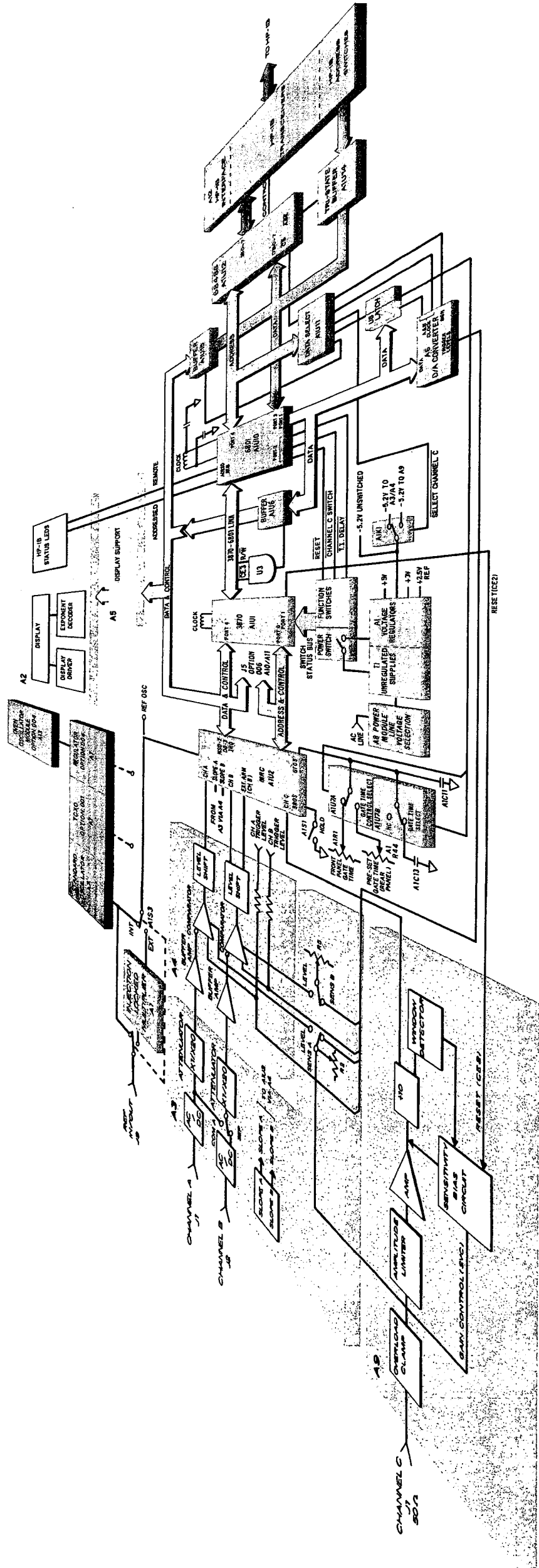
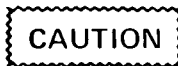

Figure 8-2 Overall Block Diagram
8-11

8-40. TROUBLESHOOTING



Proper static handling techniques must be employed when servicing semiconductor products. The voltage susceptibility of all IC and transistor families are well below levels commonly found in service environments. Exercise care and observe standard static precautions.

8-41. The following table contains some special considerations when troubleshooting the 5316A. They are listed to help avoid potential problems:

1. When making measurements at IC sockets (with the IC removed), avoid inserting the probe tip into the socket. This may cause bad contact with the IC when it is reinserted. Use a piece of 26-gauge wire and insert into the socket, and then attach the probe to the wire. When convenient, make measurements at the back side of the board.
2. Certain tests require IC's be removed from their sockets. Be sure they are placed back into the correct sockets and are oriented properly. Damage to the IC may occur if they are installed backwards or in the wrong socket. For reference they are:

3870 A1U1	1820-2131
MRC A1U2	1820-2312
6801 A1U10	1820-2333
68488 A1U12	1820-2113

U1 and U2 face right; U10 and U12 face left.

3. When one of the LSI ICs are removed they should be placed in conductive foam to avoid static damage. If conductive foam is not available, handle them by the ends of the packages.

8-42. The troubleshooting philosophy for the 5316A is to break the counter down into five main blocks so that the defective block can quickly be found. Once the defective circuit is identified, then go to the schematic diagram for that block as listed below. If the repaired circuit contains any adjustments to be set after repair, then refer to Section V and make the adjustments as described. For quick reference, *Figure 8-3, Troubleshooting Flowchart*, parallels the procedures beginning with paragraph 8-45.

8-43. Preliminary Troubleshooting

8-44. DEFECTIVE BLOCK ISOLATION. For troubleshooting purposes the 5316A can be divided into the following sections (see *Figure 8-4, Troubleshooting Block Diagram*):

1. Three input amplifiers (A, B, and C).
 - a. A3/A4 Channel A and B.
 - b. A9 Channel C Option 003.
 A2/A5 Display.
2. Main Counter A1 Motherboard.
 - a. A1 Motherboard (A1U1 3870-A1U2 RC).
 - b. A2/A5 Display.
3. HP-IB Remote Control.
 - a. A1 Motherboard. (A1U10 6801-A1U12 68488).
 - b. A6 Digital-to-Analog Converter.
 - c. A12 HP-IB Interface.

4. Time Base.
 - a. A7 Standard Oscillator.
 - b. A7 TCXO Option 001.
 - c. A7 and A13 Oven Oscillator Option 004.
 - d. Injection-locked multiplier (located on the A1 Motherboard).

5. Power supplies (on the A1 Motherboard).

A1 Motherboard/A8 Power Module	8-5
A2 Display/A5 Display Support	8-6
A3/A4 Input Amplifiers	8-7
A6 Digital-to-Analog Converter	8-8
A7 Standard Oscillator, TCXO, Oven Oscillator (A13k)	8-9
A9 Channel C Option 003	8-10
A12 HP-IB Interface	8-11

8-45. The following procedure will determine the defective block.

- a. If Option 006 Offset/Normalizer is installed, disconnect the ribbon cable from the 5316A J1 connector. This procedure does not cover Option 006, so if the 5316A will operate correctly with the cable disconnected, then the problem is on the A10/A11 assemblies in the Offset/Normalizer. Refer to the Option 006 Installation and Service Manual.
- b. Check for a blown line fuse in the A8 Power Module. If it has blown, check transformer T1, the rectifier components, and the +5 volt power supply line for short circuits (only the +5V supply will blow the fuse if shorted). The -5.2V and +3V supplies should also be checked for short circuits. The following resistance values are typical and variations can be expected. However, a short circuit will show dramatic differences from these values.

1. +5 volt supply ~420 ohms
2. -5.2 volt supply ~610 ohms
3. +3 volt supply ~530 ohms

- c. A short on the -5.2V or +3V supplies will cause the regulator transistor in that supply to become very warm. The heat sink on which the transistors are mounted should feel only slightly warm and not painful to the touch. If a short is found, the following table lists the supplies and the assemblies or circuits they power.

SUPPLY	CIRCUITS
+5V	All assemblies except A1U16
-5.2V	A1U16, A3, A4, A6, A9
+3V	A1U2 (MRC), A4, A9

- d. If no short can be found, apply power to the 5316A through a variable line transformer (Variat[®]) and monitor the +5V supply. The ac line current should be ~300 mA at 115V ac.
- e. Measure the three main power supplies. All supplies should be within the values specified below. If not, adjust the supplies to the indicated voltage.

VOLTAGE	TOLERANCE	ADJUSTMENT
+5V dc	±10 mV	A1R35
-5.2V dc	±10 mV	A1R27
+3V dc	±10 mV	A1R23

- f. If *all* supplies are found to be low, then verify +2.5V is present at A1U6 pin 2. The +2.5V reference is used on all supplies and on the A6 Digital-to-Analog Converter. If at least one supply is operating, then repair those supplies found faulty.
- g. Once the power supplies are operating, press **FREQ A**. Turn the power off then back on again. The display should show all "8's" for about 1-second and then display zero (with no input signal).

®Variat is a Registered Trademark of General Radio.

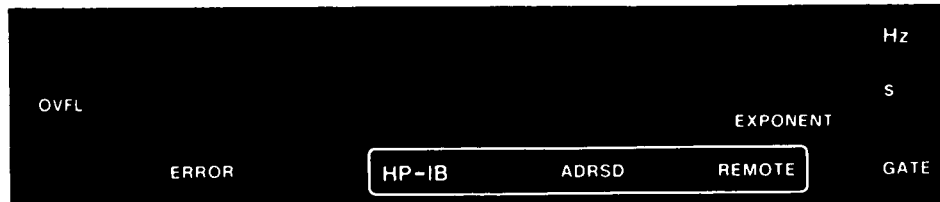

Note: If the 5316A is rapidly switched on/off then back on, it may display random segments, then all "8's", etc.

h. If, on power-up, instead all 8's the 5316A displays:

- E1 — This indicates a possible problem in the 3870 Microcomputer A1U1. Verify the failure by substituting a known good 3870 Microcomputer.
- E2 — This indicates a possible short on the MRC-3870-display driver interconnect bus, a defective MRC, or a short on A1J1 (Offset/Normalizer interface connector).
- E3 — If this is displayed, put the 5316A into the Display Check mode (all function switches out and Blue Shift key out). Turn the power off and then back on. If E2 is now displayed, the problem is a short on one of the 3870 I/O pins. If E2 is NOT displayed, then the problem may be the MRC. Next verify the INT/EXT oscillator switch on the rear panel is in the INT position. Error E3 WILL be displayed if the INT/EXT oscillator switch is in the EXT position, or if there is no signal (or insufficient) at the REF OSC test point. If it is in INT, verify that there is 10 MHz present at the REF OSC test point (this is the same point as A7P1 pin 2). See A7 Output Waveform, A7 Troubleshooting.

If the signal is correct, place the 5316A into the CHECK mode. If the number displayed does not read exactly 10 MHz, the problem is probably the MRC. Verify by substituting a known good MRC.

- i. If the HP-IB status LEDs (ADRS D and REMOTE) are flashing, then go to step m. for a description of this failure indication. Note the failure then return to Step j.
- j. Once again, release all of the Function switches and the Blue Shift key. Verify the display sequentially displays the numbers 0 through 9 and blank (see Table 3-1, Display Check). This verifies the display (A2) and indicates the 3870 is not dead, although a problem may still exist.
- k. Place the 5316A in the CHECK mode. The 5316A should display exactly 10 MHz. Apply a 10 MHz signal at 100 mV rms to Channel A Input BNC or connect the rear panel REF IN/OUT to the Channel A Input BNC. Press FREQ A. Adjust the input controls for a stable trigger. If the 5316A displays exactly 10 MHz in CHECK, but fails to count the 10 MHz input signal, then apply 50 MHz at 50 mV to the Channel C Input BNC and press FREQ C. The intent of this procedure is to determine if at least one input operates. If Channel C is not installed, then go the step l. If Channel C input operates, then the A3/A4 assembly is defective. In this case go to A3/A4 Input Amplifier Troubleshooting. If Channel A operates and Channel C does not, go to A9 Channel C Troubleshooting. If neither input operates, then continue to step l.
- l. If the problem cannot be located from the above tests, remove A1J5P1 (the 8-pin dip test jumper) and repeat tests g. and h. Ignore the flashing of the HP-IB status LED's. With the test jumper removed the LEDs will flash. If the 5316A functions correctly with the jumper removed, the failure is in the HP-IB portion, so go to step m. If the 5316A fails this test, the failure is in the counter portion. Substitute first, the 3870 and then the MRC with known good IC's since one is probably dead. Listed below are the circuits that are affected when jumper A1J5P1 is removed.
 1. A1J5P1 pins 1 and 16, NO CONNECTION.
 2. A1J5P1 pins 2 and 15 breaks the RG1 line (disabled) so the 3870 can continue to operate without 6801 response. Grounding pin 2 will pull RG1 down causing the 3870 to halt.

3. A1J5P1 pins 3 and 14 breaks the TRIGGER LEVEL POTS/ $\overline{\text{DAC}}$ line disabling the analog switches on the A6 DAC assembly (which select either the front panel Trigger Level controls, or the A6 DAC) and returns Trigger Level control to the front panel potentiometers. Grounding pin 3 will cause the A6 DAC to be selected. Ground pin 3, press **FREQ A** and vary the front panel Trigger Level controls. They should have no effect.
4. A1J5P1 pins 4 and 13 breaks the $\overline{\text{RESET COUNTER}}$ line. Thus the 6801, during power-up or when the front panel **RESET** button is pressed, does not reset the 3870. Grounding pin 4 should cause the counter to reset.
5. A1J5P1 pins 5 and 12 breaks the $\overline{\text{SELECT CHANNEL C}}$ line disabling Channel C and connecting the MRC to the Channels A and B inputs. Grounding pin 5 should cause the Channel C relay, A1K1, to switch over with a faint but audible click. The Channel A and B trigger level LED's should go off. Press **FREQ C**. A signal applied to the Channel C input BNC should now cause the 5316A to gate.
6. A1J5P1 pins 6 and 11 breaks the $33\ \mu\text{F IN}/\overline{\text{OUT}}$ line, reinserting C13. This causes the Gate Time to go into the long range (60 ms—10 s). C13 is normally connected through U7 to the GATE TIME line for long gate time range except when T.I. DELAY or CHECK is selected. C13 is also removed when the Short Gate Time range (500 μs —30 ms) is selected under remote control or by multiple key function select (see Section III, Operation). Grounding pin 6 should cause the gate time to go from long to short. Select the Gate Time mode to verify if this occurs.
7. A1J5P1 pins 7 and 10 breaks the GATE TIME LOCAL/ $\overline{\text{PRESET}}$ line so that front panel Gate Time control is always selected. Grounding pin 7 should cause the Gate Time control to be switched from the front panel Gate Time control to the rear panel Preset Gate Time.
8. A1J5P1 pins 8 and 9 breaks the enable line to U6A removing the 6801 from the 4-bit data bus. The 6801 cannot then put data on the 3870/MRC data bus. If the 3870 is removed from its socket, grounding pin 9 of the test connector will enable U6A. The input to U6A can then be pulsed and monitored at the output with a logic probe.
9. Pins 10, 11, 12, 13, and 14 when under HP-IB control; should go to their proper logic level when that particular lines function is selected. If not, look for shorts or opens on the lines or in their driver IC.

NOTE

With the test jumper removed, Channel C, T.I. Delay, and front panel Reset will not operate. These functions are selected through the 6801 Microcomputer A1U10. The jumper must be in place to operate these circuits. They can be selected, however, by grounding the appropriate pins on the jumper socket as described above.

- m. If the 5316A operates correctly with the test jumper removed, replace the test jumper, and repeat the rolling display test. Note the action of the HP-IB status LED's.

If they:

Flash in phase — This indicates a failure in the 6801. Go to the A1 Motherboard Signature Analysis Troubleshooting, paragraph 8-69.

Flash out of phase — And the 5316A operates correctly with the test jumper removed, this indicates the MRC and 3870 are good. The problem is a 3870-6801 link failure or a defective 6801. In this case, go to the A1 Motherboard Signature Analysis Troubleshooting, paragraph 8-69.

NOTE

An error E3 and "out-of-phase" flashing usually means a bad reference signal. Check the INT/EXT REF switch and the signal level of the reference driving the MRC at test point REF OSC and U2 pin 21 (500 mV-1.2V p-p).

- NOTE:
1. FLOWCHART PARALLELS PARAGRAPHS 8-4.
 2. LETTERS INDICATE CONCERNED PARAGRAPHS OF 8-4.
 3. PARALLELS INDICATE CONCERNED PARAGRAPHS OF 8-4.
 4. PARALLELS (8-7-4-1) AND (8-7-4-2) POSITION, THE ABOVE ALIAS (TEST JUMP) AND REPAIR CONTROL PORTION. REPLACE 8-7-4-1 AND 8-7-4-2 WITH CORRECT TEST IF NECESSARY.

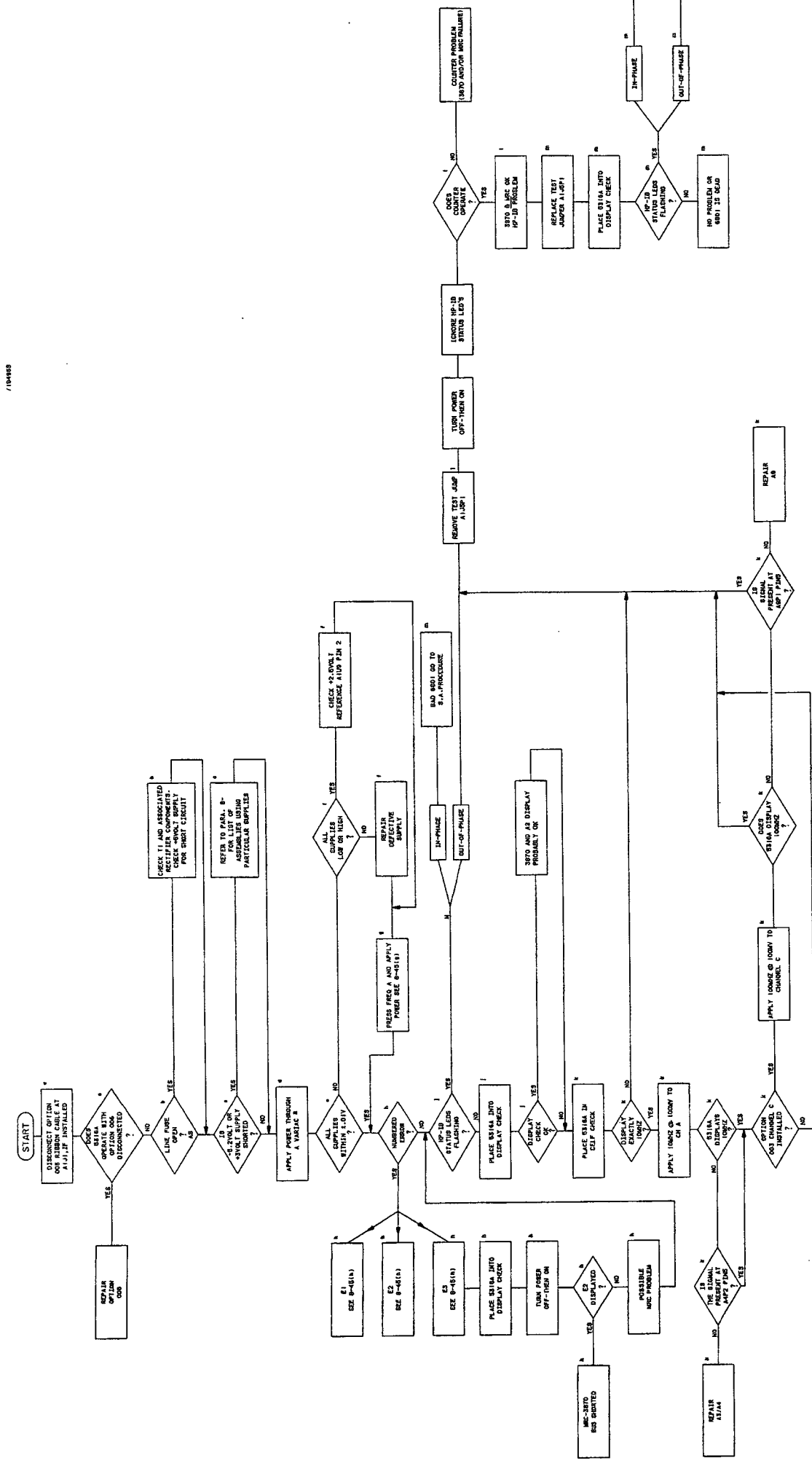

Figure 6-3. Troubleshooting Flowchart

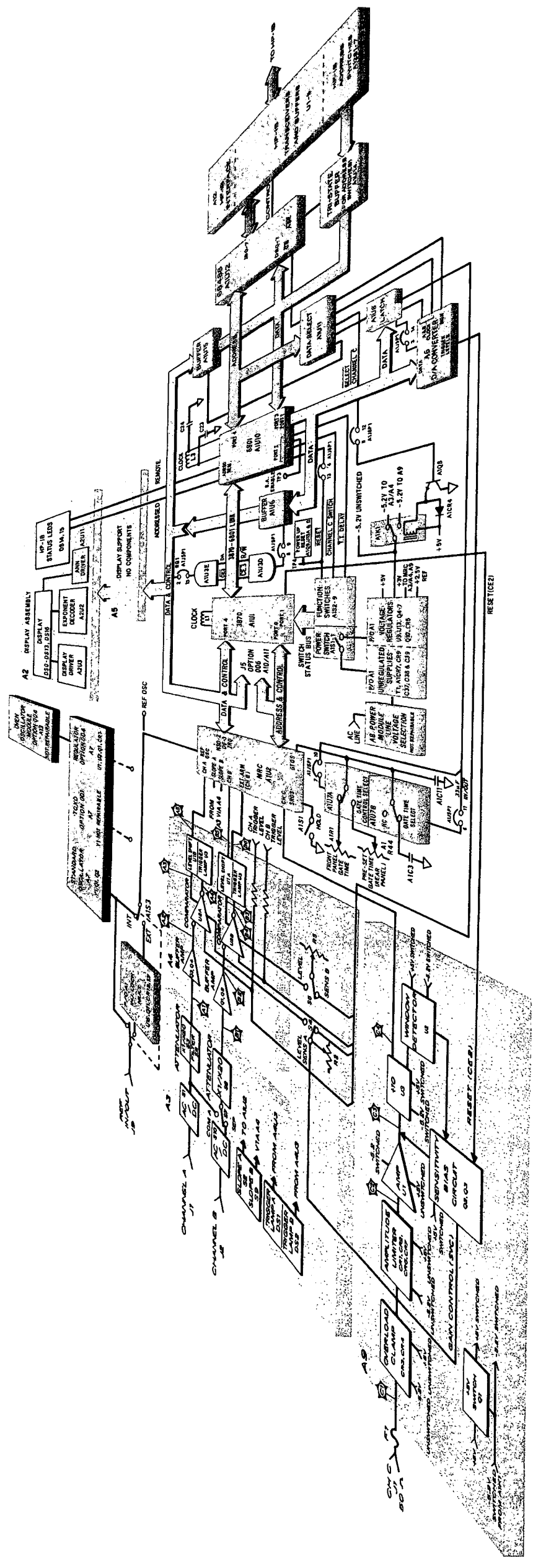

Figure 8-4. Troubleshooting Block Diagram
8-19

8-46. MAIN COUNTER THEORY (A1 MOTHERBOARD)

8-47. The A1 Motherboard assembly contains the counter microcomputer (3870), multiple register counter (MRC), HP-IB Microcomputer (6801), HP-IB Interface Adapter (68488), power supplies, and external time base circuitry. The 3870 Microcomputer runs at an internal clock rate of ~3.5 MHz, as set by L1. It continually cycles through programmed routines, which are stored in ROM within the IC. The block of function switches are routinely polled, via the Switch Status bus, and the status image is stored in internal RAM. Any change in the image is detected and verified. A new function switch setting must remain stable for 32 scans to be accepted.

8-48. The 3870 controls the operation of the MRC via the Address/Control bus. Address lines RG0 and RG1 select one of four internal registers of the MRC. NS0, NS1, and NS2 are nibble select lines, (nibble = 4 bits) which address data within the various registers. The chip select line, CS, allows or disallows the chip to respond to addresses. IRQ (Interrupt Request) signals the 3870 that the MRC requires service (i.e., when a measurement is complete). Command line R/ \overline{W} (Read/ \overline{Write}) controls the direction of data transfer on the bidirectional Data/Control Bus.

8-49. The Data/Strobe bus contains four bidirectional data lines, D0-D3, and the command line STR which indicates an address or command is valid, between the 3870, the MRC, and the Display assembly A2 (via A5).

8-50. The Exponent/Annunciator bus controls the operation of the Gate, Hz, s, “-”, and decimal point annunciator lines going to the A2 Display assembly. The four-line binary addresses on lines a, b, c, and d select the exponent to be displayed. CE1 enables the display driver IC.

8-51. The Multiplier Register Counter (MRC), a universal counter on a chip, is an LSI bipolar IC utilizing both EFL and I²L circuitry. The reference oscillator (A7) drives the MRC via pin 21 and its output can be monitored at the REF OSC test point located on the A1 Motherboard near the A7 assembly. Inputs from the Channel A and B amplifier assembly (A3/A4) are fed into the MRC at pins 30 and 28. An External Arm line (used only in FREQ A Armed by B), also from the input amplifier assembly, is connected to pin 17. The Channel C signal, if Option 003 is installed, is connected to pin 26 of the MRC.

8-52. In addition to the Address/Control and Data/Control buses from the counter microcomputer 3870, two other control lines, GTOS and SROS are routed to pins 6 and 7. GTOS is the Gate-Time-One-Shot timing node. The gate time operates over one of two ranges, as set by the Function switch S1-5. The gate time is determined by the time constant formed by R1 or R44 (front or rear panel, respectively), and the capacitor(s), C11 with or without C13, connected to GTOS through analog switch U7B. Short gate times are obtained with R1 (or R44) and C11 (500 μ s-30 ms), and longer gate times (60 ms-10 s) when C13 is added in parallel through U7B. SROS is the Sample-Rate-One-Shot timing node. One of two sample rates is selected: a short minimal sample rate, determined by the time constant of R7 and C10, or one time only in HOLD, via S2 (part of R1). With SROS Low (HOLD), the measurement will be made and displayed, but no more measurements will be made until the SROS line goes High.

8-53. Within the MRC are four addressable registers. The Events Register and Time Register are counting registers; thus they are Read Only. The Status Register monitors the operation of the MRC, and the Control Register receives the commands from the 3870 and determines the MRC's configuration.

8-54. Main Counter Troubleshooting

8-55. The preliminary troubleshooting procedure beginning with paragraph 8-45, step g., is the most effective way of finding a fault in the counter section. If the 3870 (U1) or the MRC (U2) are suspected as being at fault, substitute known good ICs.

8-56. HP-IB Theory (Remote Control)

8-57. The HP-IB Microcomputer is the 6801, U10. It operates independently of the 3870, and all data and control information has to be exchanged between these microcomputers on a handshake basis. This is done in the following manner:

8-58. When the 3870 begins a measurement cycle, it signals the 6801, via the CE3 and R/W lines that it is ready for control codes from the 6801. The interface latch circuitry, consisting of U3 and U4, presents these signals to the 6801, which pull down on RG1, keeping the 3870 from moving on to the next step until the 6801 can respond. The 6801 can send codes to the 3870 which tell it to: 1.) ignore the 6801; 2.) send the 6801 the results of the current measurement; 3.) ignore the front panel function switches and perform the function the 6801 wants it to perform; or 4.) perform the function the 6801 wants it to perform and return the measurement results to the 6801.

8-59. The control codes from the 6801 are sent to the 3870 through a three-state buffer, (U6A), which puts the data on the four-bit data bus shared by the 3870 and the MRC (D0-D3). The data from the 3870 and the handshake latch circuitry is presented to the 6801 on its own data bus (8 bits) through three-state buffers U5 and U6B. These buffers are enabled by a control signal, $\overline{3870 \text{ DATA IN}}$, from Data Selector U11 (3- to 8-line decoder), and this in turn goes active when the 6801 writes to address \$0130 (all addresses in HEXADECIMAL unless otherwise noted). When this happens, it causes the $\overline{3870 \text{ DATA IN}}$ enable line to go Low (active low), in turn sending the three-state buffers to the active state and putting the 3870 data on the 6801 data bus. Note that the codes come from the 6801 static port (Port 1), rather than the 6801 data bus. These codes are held available at all times to the 3870, so the 3870 can read them whenever ready by enabling its three-state buffers onto its own 4-bit data bus.

8-60. The Data Selector, U11, also generates enable and reset signals for other parts of the 6801 Microcomputer circuitry. Addresses \$0108-\$010F enable the 68488 HP-IB Interface. Addresses \$0110 and \$0118 clock data into the A6 Digital-to-Analog Converters for the trigger level of Channel A and B, respectively. Address \$0128 clocks data (from Port 1) into a 6-bit CMOS latch, U8. The output lines from this latch control several other functions in the 5316A.

8-61. Address \$0138 causes a reset pulse to be sent to the handshake latch, freeing the 3870 to continue its original function.

8-62. Port 1 has several functions; 1.) the 4-lower bits (0-3) send data to the 3870. The next 2 bits (4 and 5) provide the logic levels for the "ADRSD" (addressed via the HP-IB) and "REMOTE" (in the remote control state) LED's on the front panel; 2.) these six lines are also used to send control codes to the CMOS latch U8. The MSB is used as described to reset the 3870; 3.) additionally, all eight lines are used as data lines for the A6 Digital-to-Analog Converter; data is presented to the DAC's, and is clocked in by writing to addresses \$0110 or \$0118. The pins of Port 1 then resume their normal functions.

8-63. Port 2 of the 6801 (pins 8-12) has two functions. The Power-Up Reset is generated by Q9 and formed into a clean short rise-time, no-bounce TTL signal by the Schmitt inverter U15A and U15D. The resulting signal is sent to the Power-Up Reset input pins of the 3870 (U1-39), the 6801 (U10-6), and the 68488 (U12-19) interface. The 3870 initializes its programs, and the 68488 clears its registers; but the 6801, during this power-up period, reads in Mode-Select codes from the logic levels on pins 8, 9, and 10. This tells the 6801 how to configure its internal structure. In this application the mode is Expanded Nonmultiplexed; the 6801 uses its internal RAM and ROM. Port 1 is static and always defined as outputs. Port 2 is defined (by the program) as inputs. Port 3 is the bidirectional data bus, and Port 4 the lower 8 bits of the address bus. A special line, \overline{IOS} , also becomes available in this mode, and is used as one of the qualifiers on U11. A low logic level on the \overline{IOS} line means that the seven-most significant bits of the 16-bit address are all zeros, and the eighth is a "one". Hence, \overline{IOS} and the lower 8 bits of address (Port 4) defines addresses \$0100-\$01FF.

8-64. After the mode is defined, on Port 2, these same pins now serve as inputs to the 6801. The program tests their logic levels on a regular basis, and varies its operation accordingly. Pin 8 is connected to a test point, TP3; grounding this test point during program execution will send the 6801 into its signature analysis routine (power must be turned off or front panel reset depressed to exit this routine.) Pin 9 is connected to the T.I. DELAY/CHECK switch, and by selecting T.I. DELAY, a low logic level will cause the 6801 to send a low logic level through latch U8, to analog switch U7B, removing capacitor C13 from the Gate-Time-One-Shot circuit, dramatically decreasing the gate time period. Pin 11 is connected to the $\overline{\text{FREQ C/GATE TIME}}$ switch; when this line goes to a logic level Low, the $\overline{\text{CHANNEL C}}$ line from U8 is pulled Low. This in turn closes relay K1, and the -5.2V dc power is switched from the Channel A and B amplifiers to the Channel C Amplifier, (the relay also closes when Channel C is selected during remote control). Pin 12 looks at the state of latch, U4C, which is set anytime the front panel RESET button is pressed. The reset results (and the latch is cleared) whenever the 6801 puts a logic low on the line $\overline{\text{RESET COUNTER}}$ by writing a zero to pin 20, the MSB of Port 1. This is held Low long enough to reset the 3870 to its restart position.

8-65. Port 3 is used only as a data bus. It inputs the results of the measurement from the 3870 via buffers U5 and U6. It exchanges data with the 68488, HP-IB Interface Adapter. (Note that U14 three-state buffer is also tied to this data bus; it is enabled by the 68488, and the 6801 does not read its data into itself; rather, the 68488, under 6801 control, enables U14 to read in its HP-IB address switches so it will know what its address is.)

8-66. Port 4 is the lower 8 bits of the address bus. Note that pins 22 and 23, the MSB and next lower MSB, go only to the A6 DAC connector (J6); they are configured as inputs, rather than address lines and are not used. The lower six address lines select individual registers in the 68488.

8-67. Other pins on the 6801 are NMI (NonMaskable Interrupt — not used), $\overline{\text{Read/Write}}$, E, (the 6801 clock = 1 MHz), the Power-Up Reset line, and $\overline{\text{IRQ}}$. $\overline{\text{IRQ}}$ is the maskable interrupt line, which is pulled down by the 68488 whenever it has been addressed to listen to the HP-IB.

8-68. The 68488 HP-IB Interface IC (U12) is not a processor or a computer; it operates under the 6801 control. The HP-IB control lines (RFD, DAC, DAV, EOI, ATN, REN, SRQ, and IFC) cause various bits in the 68488 internal registers to go to the TRUE or FALSE state. The 6801 can read these registers to monitor the state of the bus. The eight data lines IB0-IB7 (pins 29-36) tie to the HP-IB data lines through bidirectional receiver A12U2 and can be read into the 6801 through the 6801 data bus, from pins 7-14 of the 68488. Register select RS0-RS2, tied to the three LSB address lines of the 6801, ANDed internally with Chip Select ($\overline{\text{CS}}$), determine which of the registers in the 68488 will be read from, or written to, by the 6801.

8-69. Signature Analysis Troubleshooting

8-70. The following signature analysis tests can be used to troubleshoot the 6801-3870 link and the operation of the 6801 HP-IB interface and associated components. Failures in the 3870 or MRC can only be verified by substitution.

Procedure:

1. Set the signature analyzer as follows:

START	NEGATIVE SLOPE (IN)
STOP	NEGATIVE SLOPE (IN)
CLOCK	NEGATIVE SLOPE (IN)
HOLD	OFF (OUT)
SELF TEST (5004A only)	OFF (OUT)
NORMAL (5005A only)	

2. Connect the analyzer to the following points:

CLOCK	U11 PIN 6
STOP	U8 PIN 10
START	U8 PIN 7
GROUND	U11 PIN 8
3. Set all the rear panel address switches to the down position (address 00/ADDRESSABLE). Release all the front panel function switches (OUT) including the Blue Shift key.
4. Ground TP3 for a short time. Instrument will now be in the signature analysis mode. The display will be blank with some flickering. If this does not occur, the 6801 (A1U10) is defective. Touch the 5004A probe to +5V and press the analyzer Reset button. The 5004A should display 483C. The UNSTABLE SIGNATURE lamp should be off and the GATE lamp flashing. If this does not occur, check all connections and repeat the procedure from the beginning.

In the following table:

PULSE — This means the probe lamp will be flashing.

LOW — This means the signature will be 0000 and the probe lamp will be OFF.

HIGH — This means the signature will be 483C and the probe lamp will be ON.

Signature Analysis Table

PIN	A1U8	A1U10	A1U11	A1U12
1	DO NOT MEASURE	LOW	3AU8	
2	2FU8	PULSE	80FF	
3	3PCF	PULSE	AH42	147U
4	7336	HIGH	LOW	91H4
5	95H0	HIGH	A39P	
6	A411	HIGH	PULSE	
7	FF89	HIGH	HIGH	
8	LOW	HIGH	LOW	
9	H54H	HIGH	HIGH	
10	35AA	HIGH	H54H	
11	0998	HIGH	HIGH	
12	8H94	HIGH	5H49	
13	C897	3PCF	77HP	
14	P671	7336	147U	
15	PAAC	A411	HIGH	
16	HIGH	0998	HIGH	
17		C897		
18		P671		
19		94H3		
20		P01F		
21		HIGH		
22		HIGH		
23		HIGH		
24		AH42		
25		80FF		
26		3AU8		
27		8H4A		
28		1262		
29		A7P7		
30		F79U		
31		A5H2		
32		A680		
33		7F57		
34		753U		
35		9HA8		
36		U754		
37		5200		
38		550P		
39		A39P		
40		PULSE		

8-71. Time Base Support and Injection-Locked Multiplier Theory

8-72. A 6-pin socket, J10, located near the rear of the instrument, will support either the Standard Time Base, the Optional TCXO (Option 001), or the Oven Oscillator Regulator assembly (Option 004). The INT/EXT REF OSC switch is wired in such a way that the internal reference oscillator is fed to the rear panel through BNC connector J9 when the switch is in the INT position. This output is ac coupled through C47 and C48 and isolated by R39; its output amplitude is nominally 50 mV p-p into 50 ohms.

8-73. When the switch is in the EXT position, the internal reference oscillator output is disconnected and an external input signal (connected to J9 REF IN/OUT) is connected to pin 10 of ECL line receiver, U16. Q11 detects the presence of an incoming EXT REF signal, activating the injection-lock buffer oscillator. External frequencies of 1.0, 5.0, or 10.0 MHz at 1V rms amplitude fed into J9 are amplified, level-shifted by U16C and applied to a one-shot formed by U16B and D. The resulting narrow pulses (1, 5, or 10 MHz) are applied through a capacitor C43 to one of the input nodes of tank-LC oscillator U16A, whose oscillation frequency (~ 10 MHz) is determined by L2 and C44. (C45 allows coarse adjustment and C50 allows fine adjustments.) The nominal 10 MHz frequency of U16A is locked to the incoming pulses from U16B, such that the reference frequency used in the 5316A is now a tracking multiple of the EXT input reference.

8-74. For a 1.0 MHz input reference, the injection locked oscillator will track the input frequency for at least a variation of $\pm 0.1\%$ (i.e., 1.000100 to .9999000 MHz). For 5 and 10 MHz the lock range is wider.

8-75. Injection-Locked Multiplier Troubleshooting

8-76. To troubleshoot the Injection-Lock Multiplier, verify -5.2V is present at U16 pin 8, then trace the external input signal through the multiplier. The four figures below show the typical waveforms to be found at U16 pins 10, 15, 3, and 2 (listed in order of signal flow) with a 1 MHz input signal at 1V rms).

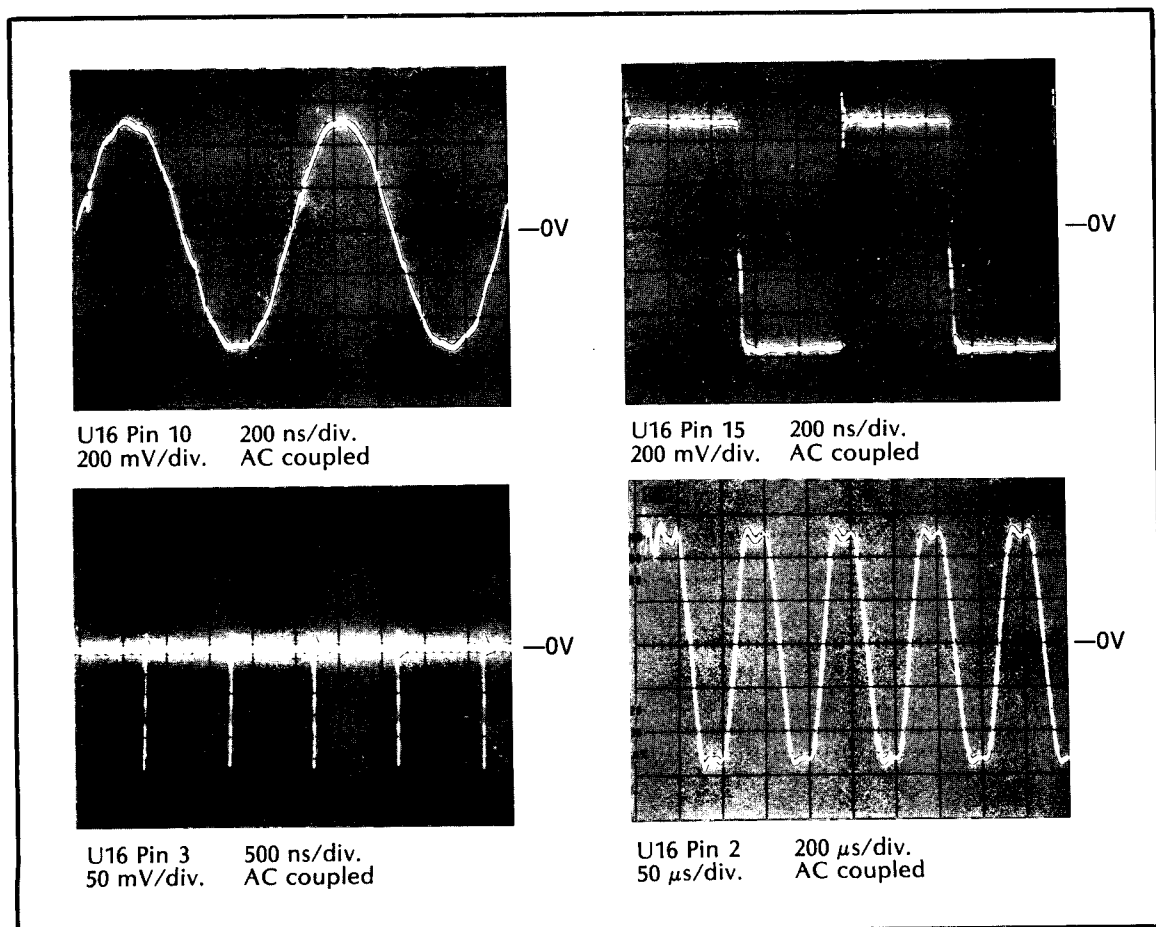

Part of Figure 8-5. A1 Counter Porton Assembly

8-77. The tank oscillator formed around U16A may be enabled to oscillate by connecting the base of Q11 (turn-off control) to the -5.2V supply. No external input is required. The tank circuit should oscillate very close to 10 MHz, depending on the settings of C45 and C50. If making this connection causes the circuit to oscillate but it does not function under normal conditions, then suspect CR12 or CR13.

8-78. Power Supplies

8-79. The 5316A power supplies provide three voltages; +5, +3, and -5.2V. A +2.5V supply (derived separately), is used only as a reference for the three main supplies and the A6 Digital-to-Analog Converter.

8-80. The A8 Power Module contains a connector for an ac power cord, fuse, and a PC card. The PC card can be inserted in any one of four positions to select 100-, 120-, 200-, 240-volt operation. The schematic diagram of the module is shown in *Figure 8-5*. A detailed description, including instructions for changing the fuse or voltage selection is given in paragraph 2-8.

8-81. Once the proper line voltage has been selected by the Line Module A8, this voltage is applied to the primary of transformer T1. The secondary winding of T1 is connected to the A1 Motherboard through connector J7. T1 has one secondary winding tapped for two voltages.

8-82. The higher voltage output (blue leads) is used in conjunction with rectifier CR7, and filter capacitors C37 and C39 to develop approximately $\pm 7.5V$ unregulated. The unregulated +7.5V supply is switched through the rear-half of power switch S1-1 to two circuits:

1. Pin 1 of U9 to provide a +2.5V reference (output on pin 2) for the three-main supply voltage regulators +5, +3, and -5.2V supplies, and the A6 Digital-to-Analog Converter.
2. Pin 4 of U13 to develop the +5V supply. It should be noted that U13 is a quad operational amplifier. U13 is powered by the unregulated $\pm 7.5V$ supplies at pins 4 and 11, respectively. However, the -7.5V supply is applied to U13 at all times, regardless of the position of S1-1. The +5V supply consists of series regulator Q7, Q5, U13B, and associated components. The voltage dividers, R26, R30, and R35 at the collector of Q7 determines the amount of feedback to be applied to the inverting input U13B. R35 is adjusted for +5V at the collector of Q10. The +2.5V reference is applied to pin 10 of U13B, the noninverting input.

8-83. The unregulated -7.5V supply is switched through the front section of power switch S1-1 to two circuits:

1. As the negative supply voltage for U13 at pin 11.
2. To the emitter of Q10 to develop the -5.2V supply. The -5.2V supply consists of series regulator Q10, U13D, and associated circuitry. The voltage dividers R19, R27, and R32 at the collector of Q10 determines the amount of feedback applied to the noninverting input of U13D. R27 is adjusted for -5.2V at the collector of Q10. Zener diode CR5 provides over-voltage protection under zero-load conditions.

8-84. The -5.2V supply is used for the A3/A4 A and B Input Amplifiers or the A9 Channel C Amplifier. Relay K1 switches the -5.2V supply to either assembly depending on the input to be used. The -5.2V supply is NOT applied to both A/B and Channel C at the same time. The only exception is a special -5.2V line (labelled -5.2V UNSWITCHED) connected to the Channel C input protection circuitry and the trigger level controls on the A3 Input Amplifier assembly to be used as the Channel C gain control. This allows the Channel C input to be protected from being over-voltaged by an input signal even though the Channel C is not being used. Relay K1, when not energized, supplies -5.2V to the A and B amplifiers. Whenever Channel C is selected from the front panel or under remote control, K1 is

activated by a logic Low on the SELECT CHANNEL C line. This turns on Q8 allowing current to flow through the relays coil, switching the -5.2V to the Channel C Amplifier. SELECT CHANNEL C is generated by the 6801, U10 when:

1. In local, when the front panel FREQ C button is depressed, pulling CHANNEL C SWITCH line Low, or;
2. In remote, when function code FN5 is sent to the 5316A via the HP-IB.

8-85. The lower voltage taps (white leads) of transformer T1 in conjunction with CR8, CR9, and C38 provide an unregulated +4V supply which is used to develop the +3V supply. The +3V regulator consists of series regulator Q4, Q6, U13A, and associated circuitry. The voltage dividers R22, R23, and R34 determines the amount of feedback applied to the inverting input of U13A at pin 2. R23 is adjusted for +3V at the collector of Q4. The +2.5V reference is applied to U13A at pin 3.

8-86. Power Supply Troubleshooting

8-87. The troubleshooting for the power supplies can be found under Preliminary Troubleshooting, paragraph 8-45, step b. If all supplies are low, measure the voltage at A1U9, the +2.5V reference.

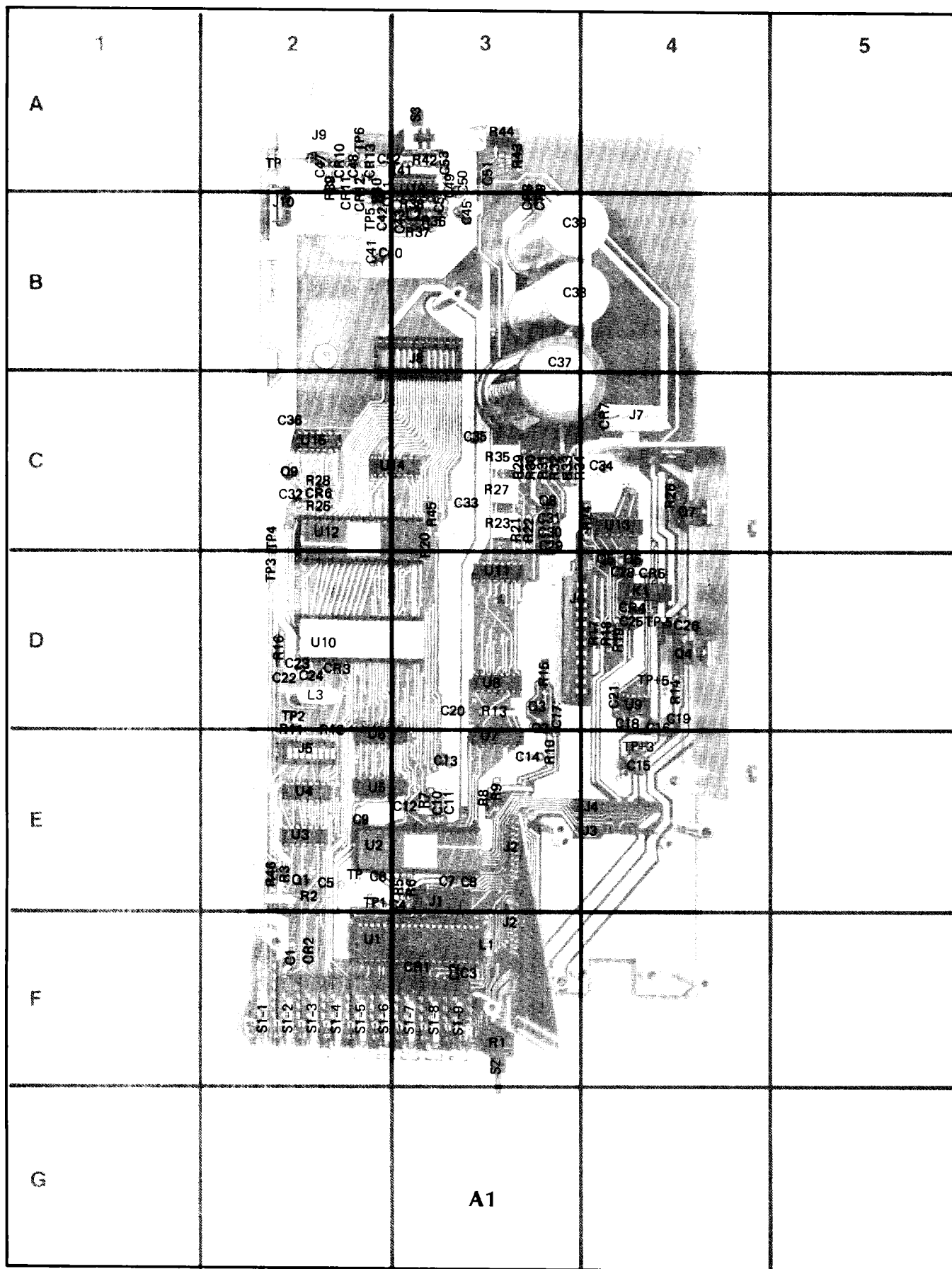

Part of Figure 8-5. A1 Counter Portion Assembly

A B C D E F

Figure 8-5. A1 Motherboard (Counter Portion)
(Sheet 1 of 2)
8-29

GRID LOCATIONS			
REF	CA	SCHEMATIC	REF
AKC1	F2	D11	AIR21
AKC2	F3	A10	AIR22
AKC3	F3	A10	AIR23
AKC4	F3	A10	AIR24
AKC5	F2	A4	AIR25
AKC6	F3	A4	AIR26
AKC7	F3	A4	AIR27
AKC8	F3	A4	AIR28
AKC9	F3	A4	AIR29
AKC10	F3	A4	AIR30
AKC11	F3	A4	AIR31
AKC12	F3	A4	AIR32
AKC13	F3	A4	AIR33
AKC14	F3	A4	AIR34
AKC15	F3	A4	AIR35
AKC16	F3	A4	AIR36
AKC17	F3	A4	AIR37
AKC18	F3	A4	AIR38
AKC19	F3	A4	AIR39
AKC20	F3	A4	AIR40
AKC21	F3	A4	AIR41
AKC22	F3	A4	AIR42
AKC23	F3	A4	AIR43
AKC24	F3	A4	AIR44
AKC25	F3	A4	AIR45
AKC26	F3	A4	AIR46
AKC27	F3	A4	AIR47
AKC28	F3	A4	AIR48
AKC29	F3	A4	AIR49
AKC30	F3	A4	AIR50
AKC31	F3	A4	AIR51
AKC32	F3	A4	AIR52
AKC33	F3	A4	AIR53
AKC34	F3	A4	AIR54
AKC35	F3	A4	AIR55
AKC36	F3	A4	AIR56
AKC37	F3	A4	AIR57
AKC38	F3	A4	AIR58
AKC39	F3	A4	AIR59
AKC40	F3	A4	AIR60
AKC41	F3	A4	AIR61
AKC42	F3	A4	AIR62
AKC43	F3	A4	AIR63
AKC44	F3	A4	AIR64
AKC45	F3	A4	AIR65
AKC46	F3	A4	AIR66
AKC47	F3	A4	AIR67
AKC48	F3	A4	AIR68
AKC49	F3	A4	AIR69
AKC50	F3	A4	AIR70
AKC51	F3	A4	AIR71
AKC52	F3	A4	AIR72
AKC53	F3	A4	AIR73
AKC54	F3	A4	AIR74
AKC55	F3	A4	AIR75
AKC56	F3	A4	AIR76
AKC57	F3	A4	AIR77
AKC58	F3	A4	AIR78
AKC59	F3	A4	AIR79
AKC60	F3	A4	AIR80
AKC61	F3	A4	AIR81
AKC62	F3	A4	AIR82
AKC63	F3	A4	AIR83
AKC64	F3	A4	AIR84
AKC65	F3	A4	AIR85
AKC66	F3	A4	AIR86
AKC67	F3	A4	AIR87
AKC68	F3	A4	AIR88
AKC69	F3	A4	AIR89
AKC70	F3	A4	AIR90
AKC71	F3	A4	AIR91
AKC72	F3	A4	AIR92
AKC73	F3	A4	AIR93
AKC74	F3	A4	AIR94
AKC75	F3	A4	AIR95
AKC76	F3	A4	AIR96
AKC77	F3	A4	AIR97
AKC78	F3	A4	AIR98
AKC79	F3	A4	AIR99
AKC80	F3	A4	AIR100

REF	CA	SCHEMATIC	REF
AKC81	F3	A4	AIR101
AKC82	F3	A4	AIR102
AKC83	F3	A4	AIR103
AKC84	F3	A4	AIR104
AKC85	F3	A4	AIR105
AKC86	F3	A4	AIR106
AKC87	F3	A4	AIR107
AKC88	F3	A4	AIR108
AKC89	F3	A4	AIR109
AKC90	F3	A4	AIR110
AKC91	F3	A4	AIR111
AKC92	F3	A4	AIR112
AKC93	F3	A4	AIR113
AKC94	F3	A4	AIR114
AKC95	F3	A4	AIR115
AKC96	F3	A4	AIR116
AKC97	F3	A4	AIR117
AKC98	F3	A4	AIR118
AKC99	F3	A4	AIR119
AKC100	F3	A4	AIR120
AKC101	F3	A4	AIR121
AKC102	F3	A4	AIR122
AKC103	F3	A4	AIR123
AKC104	F3	A4	AIR124
AKC105	F3	A4	AIR125
AKC106	F3	A4	AIR126
AKC107	F3	A4	AIR127
AKC108	F3	A4	AIR128
AKC109	F3	A4	AIR129
AKC110	F3	A4	AIR130
AKC111	F3	A4	AIR131
AKC112	F3	A4	AIR132
AKC113	F3	A4	AIR133
AKC114	F3	A4	AIR134
AKC115	F3	A4	AIR135
AKC116	F3	A4	AIR136
AKC117	F3	A4	AIR137
AKC118	F3	A4	AIR138
AKC119	F3	A4	AIR139
AKC120	F3	A4	AIR140
AKC121	F3	A4	AIR141
AKC122	F3	A4	AIR142
AKC123	F3	A4	AIR143
AKC124	F3	A4	AIR144
AKC125	F3	A4	AIR145
AKC126	F3	A4	AIR146
AKC127	F3	A4	AIR147
AKC128	F3	A4	AIR148
AKC129	F3	A4	AIR149
AKC130	F3	A4	AIR150
AKC131	F3	A4	AIR151
AKC132	F3	A4	AIR152
AKC133	F3	A4	AIR153
AKC134	F3	A4	AIR154
AKC135	F3	A4	AIR155
AKC136	F3	A4	AIR156
AKC137	F3	A4	AIR157
AKC138	F3	A4	AIR158
AKC139	F3	A4	AIR159
AKC140	F3	A4	AIR160
AKC141	F3	A4	AIR161
AKC142	F3	A4	AIR162
AKC143	F3	A4	AIR163
AKC144	F3	A4	AIR164
AKC145	F3	A4	AIR165
AKC146	F3	A4	AIR166
AKC147	F3	A4	AIR167
AKC148	F3	A4	AIR168
AKC149	F3	A4	AIR169
AKC150	F3	A4	AIR170
AKC151	F3	A4	AIR171
AKC152	F3	A4	AIR172
AKC153	F3	A4	AIR173
AKC154	F3	A4	AIR174
AKC155	F3	A4	AIR175
AKC156	F3	A4	AIR176
AKC157	F3	A4	AIR177
AKC158	F3	A4	AIR178
AKC159	F3	A4	AIR179
AKC160	F3	A4	AIR180
AKC161	F3	A4	AIR181
AKC162	F3	A4	AIR182
AKC163	F3	A4	AIR183
AKC164	F3	A4	AIR184
AKC165	F3	A4	AIR185
AKC166	F3	A4	AIR186
AKC167	F3	A4	AIR187
AKC168	F3	A4	AIR188
AKC169	F3	A4	AIR189
AKC170	F3	A4	AIR190
AKC171	F3	A4	AIR191
AKC172	F3	A4	AIR192
AKC173	F3	A4	AIR193
AKC174	F3	A4	AIR194
AKC175	F3	A4	AIR195
AKC176	F3	A4	AIR196
AKC177	F3	A4	AIR197
AKC178	F3	A4	AIR198
AKC179	F3	A4	AIR199
AKC180	F3	A4	AIR200

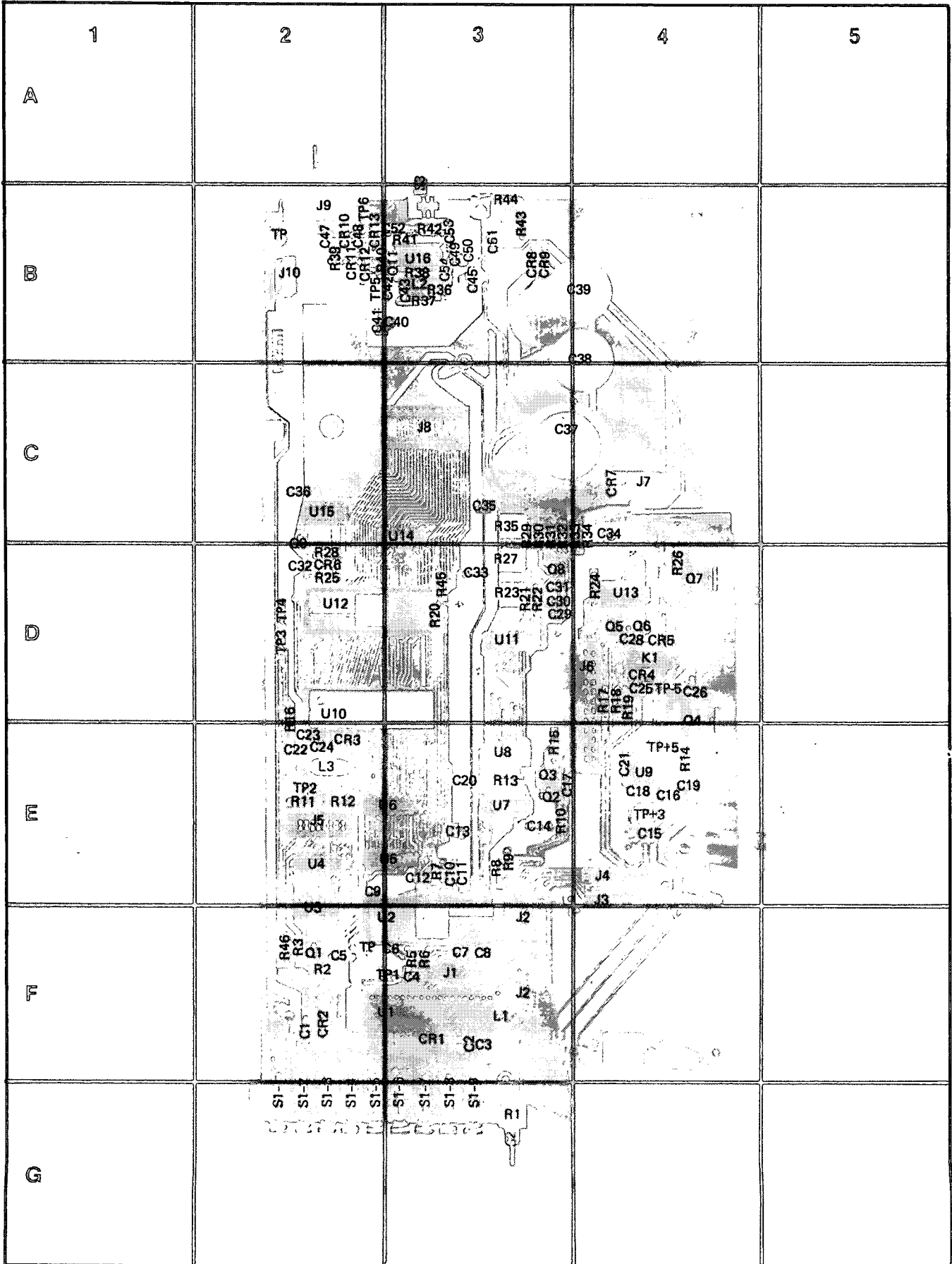

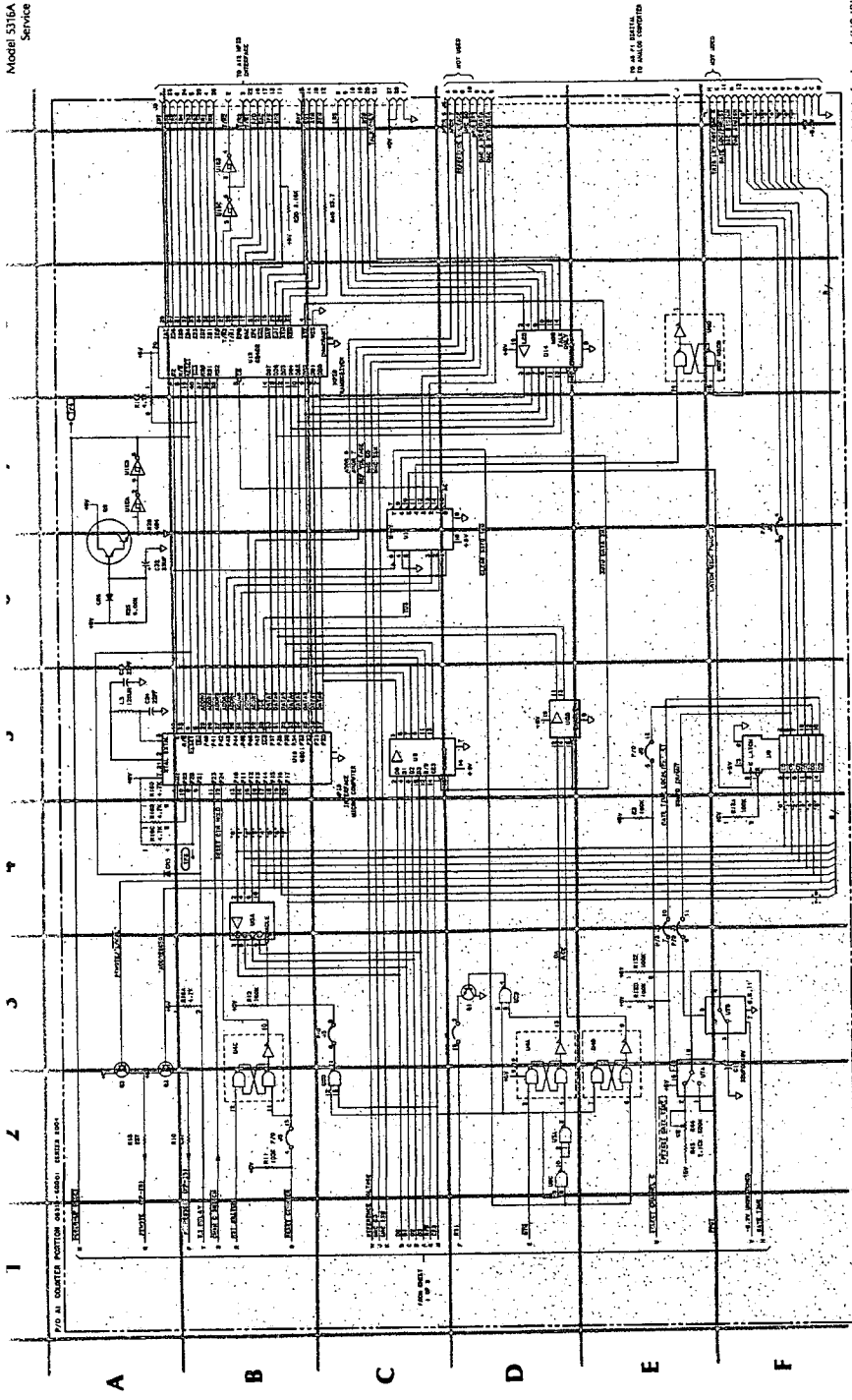
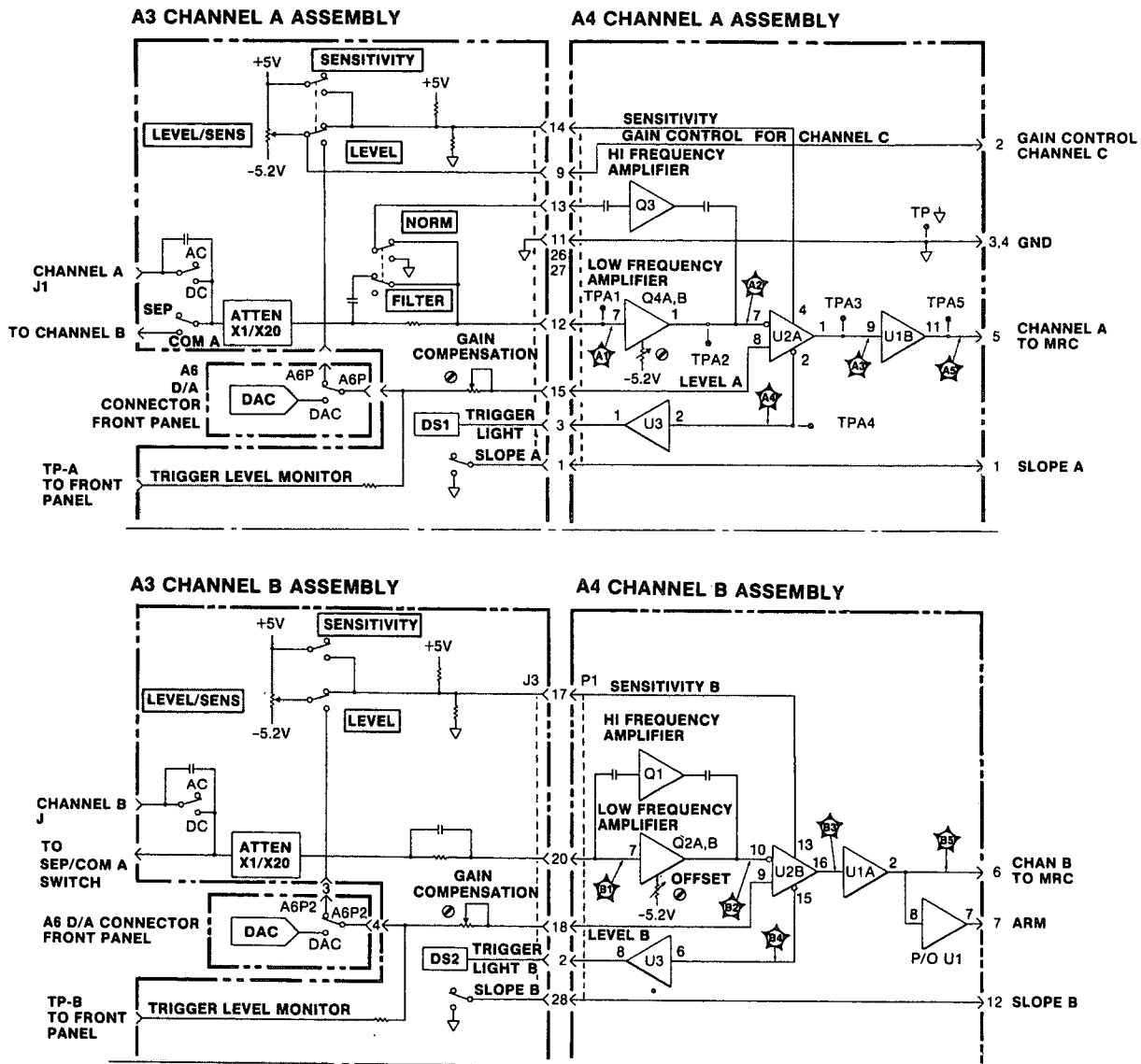

Figure 8-5. A11 Motherboard (HF-1B)
(Sheet 2 of 2)

GRID LOCATIONS											
REF DESIG	C/A	SCHEMATIC	REF DESIG	C/A	SCHEMATIC	REF DESIG	C/A	SCHEMATIC	REF DESIG	C/A	SCHEMATIC
A1C1	F2	D11	A1R21	C3	E7	A1R22	F2	F7	A1R23	F3	F7
A1C2	F3	A10	A1R24	C4	E8	A1R25	F3	F8	A1R26	F4	F8
A1C3	F3	A10	A1R27	C4	E9	A1R28	F4	F9	A1R29	F4	F9
A1C4	F3	A10	A1R29	C4	E9	A1R30	F4	F9	A1R31	F4	F9
A1C5	F3	A10	A1R31	C4	E9	A1R32	F4	F9	A1R33	F4	F9
A1C6	F3	A10	A1R32	C4	E9	A1R34	F4	F9	A1R35	F4	F9
A1C7	F3	A10	A1R33	C4	E9	A1R36	F4	F9	A1R37	F4	F9
A1C8	F3	A10	A1R34	C4	E9	A1R38	F4	F9	A1R39	F4	F9
A1C9	F3	A10	A1R35	C4	E9	A1R40	F4	F9	A1R41	F4	F9
A1C10	F3	A10	A1R36	C4	E9	A1R42	F4	F9	A1R43	F4	F9
A1C11	F3	A10	A1R37	C4	E9	A1R44	F4	F9	A1R45	F4	F9
A1C12	F3	A10	A1R38	C4	E9	A1R46	F4	F9	A1R47	F4	F9
A1C13	F3	A10	A1R39	C4	E9	A1R48	F4	F9	A1R49	F4	F9
A1C14	F3	A10	A1R40	C4	E9	A1R50	F4	F9	A1R51	F4	F9
A1C15	F3	A10	A1R41	C4	E9	A1R52	F4	F9	A1R53	F4	F9
A1C16	F3	A10	A1R42	C4	E9	A1R54	F4	F9	A1R55	F4	F9
A1C17	F3	A10	A1R43	C4	E9	A1R56	F4	F9	A1R57	F4	F9
A1C18	F3	A10	A1R44	C4	E9	A1R58	F4	F9	A1R59	F4	F9
A1C19	F3	A10	A1R45	C4	E9	A1R60	F4	F9	A1R61	F4	F9
A1C20	F3	A10	A1R46	C4	E9	A1R62	F4	F9	A1R63	F4	F9
A1C21	F3	A10	A1R47	C4	E9	A1R64	F4	F9	A1R65	F4	F9
A1C22	F3	A10	A1R48	C4	E9	A1R66	F4	F9	A1R67	F4	F9
A1C23	F3	A10	A1R49	C4	E9	A1R68	F4	F9	A1R69	F4	F9
A1C24	F3	A10	A1R50	C4	E9	A1R70	F4	F9	A1R71	F4	F9
A1C25	F3	A10	A1R51	C4	E9	A1R72	F4	F9	A1R73	F4	F9
A1C26	F3	A10	A1R52	C4	E9	A1R74	F4	F9	A1R75	F4	F9
A1C27	F3	A10	A1R53	C4	E9	A1R76	F4	F9	A1R77	F4	F9
A1C28	F3	A10	A1R54	C4	E9	A1R78	F4	F9	A1R79	F4	F9
A1C29	F3	A10	A1R55	C4	E9	A1R80	F4	F9	A1R81	F4	F9
A1C30	F3	A10	A1R56	C4	E9	A1R82	F4	F9	A1R83	F4	F9
A1C31	F3	A10	A1R57	C4	E9	A1R84	F4	F9	A1R85	F4	F9
A1C32	F3	A10	A1R58	C4	E9	A1R86	F4	F9	A1R87	F4	F9
A1C33	F3	A10	A1R59	C4	E9	A1R88	F4	F9	A1R89	F4	F9
A1C34	F3	A10	A1R60	C4	E9	A1R90	F4	F9	A1R91	F4	F9
A1C35	F3	A10	A1R61	C4	E9	A1R92	F4	F9	A1R93	F4	F9
A1C36	F3	A10	A1R62	C4	E9	A1R94	F4	F9	A1R95	F4	F9
A1C37	F3	A10	A1R63	C4	E9	A1R96	F4	F9	A1R97	F4	F9
A1C38	F3	A10	A1R64	C4	E9	A1R98	F4	F9	A1R99	F4	F9
A1C39	F3	A10	A1R65	C4	E9	A1R100	F4	F9	A1R101	F4	F9
A1C40	F3	A10	A1R66	C4	E9	A1R102	F4	F9	A1R103	F4	F9
A1C41	F3	A10	A1R67	C4	E9	A1R104	F4	F9	A1R105	F4	F9
A1C42	F3	A10	A1R68	C4	E9	A1R106	F4	F9	A1R107	F4	F9
A1C43	F3	A10	A1R69	C4	E9	A1R108	F4	F9	A1R109	F4	F9
A1C44	F3	A10	A1R70	C4	E9	A1R110	F4	F9	A1R111	F4	F9
A1C45	F3	A10	A1R71	C4	E9	A1R112	F4	F9	A1R113	F4	F9
A1C46	F3	A10	A1R72	C4	E9	A1R114	F4	F9	A1R115	F4	F9
A1C47	F3	A10	A1R73	C4	E9	A1R116	F4	F9	A1R117	F4	F9
A1C48	F3	A10	A1R74	C4	E9	A1R118	F4	F9	A1R119	F4	F9
A1C49	F3	A10	A1R75	C4	E9	A1R120	F4	F9	A1R121	F4	F9
A1C50	F3	A10	A1R76	C4	E9	A1R122	F4	F9	A1R123	F4	F9
A1C51	F3	A10	A1R77	C4	E9	A1R124	F4	F9	A1R125	F4	F9
A1C52	F3	A10	A1R78	C4	E9	A1R126	F4	F9	A1R127	F4	F9
A1C53	F3	A10	A1R79	C4	E9	A1R128	F4	F9	A1R129	F4	F9
A1C54	F3	A10	A1R80	C4	E9	A1R130	F4	F9	A1R131	F4	F9
A1C55	F3	A10	A1R81	C4	E9	A1R132	F4	F9	A1R133	F4	F9
A1C56	F3	A10	A1R82	C4	E9	A1R134	F4	F9	A1R135	F4	F9
A1C57	F3	A10	A1R83	C4	E9	A1R136	F4	F9	A1R137	F4	F9
A1C58	F3	A10	A1R84	C4	E9	A1R138	F4	F9	A1R139	F4	F9
A1C59	F3	A10	A1R85	C4	E9	A1R140	F4	F9	A1R141	F4	F9
A1C60	F3	A10	A1R86	C4	E9	A1R142	F4	F9	A1R143	F4	F9
A1C61	F3	A10	A1R87	C4	E9	A1R144	F4	F9	A1R145	F4	F9
A1C62	F3	A10	A1R88	C4	E9	A1R146	F4	F9	A1R147	F4	F9
A1C63	F3	A10	A1R89	C4	E9	A1R148	F4	F9	A1R149	F4	F9
A1C64	F3	A10	A1R90	C4	E9	A1R150	F4	F9	A1R151	F4	F9
A1C65	F3	A10	A1R91	C4	E9	A1R152	F4	F9	A1R153	F4	F9
A1C66	F3	A10	A1R92	C4	E9	A1R154	F4	F9	A1R155	F4	F9
A1C67	F3	A10	A1R93	C4	E9	A1R156	F4	F9	A1R157	F4	F9
A1C68	F3	A10	A1R94	C4	E9	A1R158	F4	F9	A1R159	F4	F9
A1C69	F3	A10	A1R95	C4	E9	A1R160	F4	F9	A1R161	F4	F9
A1C70	F3	A10	A1R96	C4	E9	A1R162	F4	F9	A1R163	F4	F9
A1C71	F3	A10	A1R97	C4	E9	A1R164	F4	F9	A1R165	F4	F9
A1C72	F3	A10	A1R98	C4	E9	A1R166	F4	F9	A1R167	F4	F9
A1C73	F3	A10	A1R99	C4	E9	A1R168	F4	F9	A1R169	F4	F9
A1C74	F3	A10	A1R100	C4	E9	A1R170	F4	F9	A1R171	F4	F9
A1C75	F3	A10	A1R101	C4	E9	A1R172	F4	F9	A1R173	F4	F9
A1C76	F3	A10	A1R102	C4	E9	A1R174	F4	F9	A1R175	F4	F9
A1C77	F3	A10	A1R103	C4	E9	A1R176	F4	F9	A1R177	F4	F9
A1C78	F3	A10	A1R104	C4	E9	A1R178	F4	F9	A1R179	F4	F9
A1C79	F3	A10	A1R105	C4	E9	A1R180	F4	F9	A1R181	F4	F9
A1C80	F3	A10	A1R106	C4	E9	A1R182	F4	F9	A1R183	F4	F9
A1C81	F3	A10	A1R107	C4	E9	A1R184	F4	F9	A1R185	F4	F9
A1C82	F3	A10	A1R108	C4	E9	A1R186	F4	F9	A1R187	F4	F9
A1C83	F3	A10	A1R109	C4	E9	A1R188	F4	F9	A1R189	F4	F9
A1C84	F3	A10	A1R110	C4	E9	A1R190	F4	F9	A1R191	F4	F9
A1C85	F3	A10	A1R111	C4	E9	A1R192	F4	F9	A1R193	F4	F9
A1C86	F3	A10	A1R112	C4	E9	A1R194	F4	F9	A1R195	F4	F9
A1C87	F3	A10	A1R113	C4	E9	A1R196	F4	F9	A1R197	F4	F9
A1C88	F3	A10	A1R114	C4	E9	A1R198	F4	F9	A1R199	F4	F9
A1C89	F3	A10	A1R115	C4	E9	A1R200	F4	F9	A1R201	F4	F9
A1C90	F3	A10	A1R116	C4	E9	A1R202	F4	F9	A1R203	F4	F9
A1C91	F3	A10	A1R117	C4	E9	A1R204	F4	F9	A1R205	F4	F9
A1C92	F3	A10	A1R118	C4	E9	A1R206	F4	F9	A1R207	F4	F9
A1C93	F3	A10	A1R119	C4	E9	A1R208	F4	F9	A1R209	F4	F9
A1C94	F3	A10	A1R120	C4	E9	A1R210	F4	F9	A1R211	F4	F9
A1C95	F3	A10	A1R121	C4	E9	A1R212	F4	F9	A1R213	F4	F9
A1C96	F3	A10	A1R122	C4	E9	A1R214	F4	F9	A1R215	F4	F9
A1C97	F3	A10	A1R123	C4	E9	A1R216	F4	F9	A1R217	F4	F9
A1C98	F3	A10	A1R124	C4	E9	A1R218	F4	F9	A1R219	F4	F9
A1C99	F3	A10	A1R125	C4	E9	A1R220	F4	F9	A1R221	F4	F9
A1C100	F3	A10	A1R126	C4	E9	A1R222	F4	F9	A1R223	F4	F9
A1C101	F3	A10	A1R127	C4	E9	A1R224	F4	F9	A1R225	F4	F9
A1C102	F3	A10	A1R128	C4	E9	A1R226	F4	F9	A1R227	F4	F9
A1C103	F3	A10	A1R129	C4	E9	A1R228	F4	F9	A1R229	F4	F9
A1C104	F3	A10	A1R130	C4	E9	A1R230	F4	F9	A1R231	F4	F9
A1C105	F3	A10	A1R131	C4	E9	A1R232	F4	F9	A1R233	F4	F9
A1C106	F3	A10	A1R132	C4	E9	A1R234	F4	F9	A1R235	F4	F9
A1C107	F3	A10	A1R133	C4	E9	A1R236	F4	F9	A1R237	F4	F9
A1C108	F3	A10	A1R134	C4	E9	A1R238	F4	F9	A1R239	F4	F9
A1C109	F3	A10	A1R135	C4	E9	A1R240	F4	F9	A1R241	F4	F9
A1C110	F3	A10	A1R136	C4	E9	A1R242	F4	F9	A1R243	F4	F9
A1C111	F3	A10	A1R137	C4	E9	A1R244	F4	F9	A1R245	F4	F9
A1C112	F3	A10	A1R138	C4	E9	A1R246	F4	F9	A1R247	F4	F9
A1C113	F3	A10	A1R139	C4	E9						



8-88. CHANNEL A AND B THEORY

8-89. The A3 and A4 assemblies may be divided into the following sections:

A3 INPUT SWITCH ASSEMBLY

- AC/DC coupling.
- Separate/Common switch.
- Attenuator X1/X20.
- 100 kHz Low-Pass Filter (Channel A only).
- Trigger Level/Sensitivity Controls.
- Slope Switches.
- Trigger Level LEDs.
- Trigger Level Monitor Jacks.

A4 INPUT AMPLIFIER ASSEMBLY

- a. High impedance buffer stage.
- b. Schmitt trigger stage.
- c. Level shifters.
- d. Trigger LED drivers.
- e. Various input switch assembly interconnect to the A1 Motherboard.

8-90. A3 Input Switch Assembly

8-91. A3 contains the Channel A and B signal conditioning switches, the Trigger Level/Sensitivity controls, and trigger lights. S1 and S10 select either ac or dc coupling. S7 is the SEP/COM A which allows the Channel B amplifier to be driven by either the Channel B BNC (J2), or the Channel A BNC (J1) in COM A. S3 (Ch A) and S8 (Ch B) select X1 and X20 attenuation by switching in or out the voltage dividers R7, R8, C5, C7 (Ch A), and R12, R13, C9, C10 (Ch B). C5, C7, C9, and C10 compensate for stray coupling at high frequencies. R9, R10, C8, and R14, R15, C11 form current limiting networks. CR1, CR2, and CR3, CR4 are voltage limiters.

8-92. S5 selects normal or low-pass filter configuration for Channel A. In the low-pass filter mode, C8 is disconnected, and high frequency input on pin 13 is connected to ground. The combination of R10, stray capacitance and the input capacitance of the amplifier on A4, roll off the frequencies above 100 kHz.

8-93. The LEVEL/SENS controls R2 and R5 provide adjustable dc levels, from +5V to -5.2V for use with either the LEVEL or SENSITIVITY outputs. With S4 or S6 in the SENSITIVITY position, the voltage swing is applied to the divider networks R3, R1F, and R4, R6F providing a voltage swing of $\sim +44$ to -70 mV to the sensitivity node of the A4 comparators. The LEVEL outputs default to 0V dc. With the switches set to the TRIGGER LEVEL position, the SENSITIVITY outputs are tied high (to +5V; this applies +44 mV to the sensitivity port (pin 4) of the Schmitt trigger on A4U2), and the trigger level potentiometer voltage swing is divided in half via resistor networks in R1 and R6. A voltage swing of $\sim \pm 2.5$ V is output to the Trigger Level inputs of A4 comparators. The wiper of R2 is also routed to A9 to be used as the sensitivity control for Option 003, Channel C. The trigger voltage is set either by the front panel Trigger Level control or A6 Digital-to-Analog Converter, and can be monitored at the front panel Trigger Level Out jacks. These voltages are taken through R1E and R6E for Channels A and B, respectively.

8-94. S2 and S9 are the Slope switches which pull to ground, or allow to float high, the Slope A and/or Slope B lines. These lines are routed through A4 to the 3870 on A1. DS1 and DS2 are the Channel A and Channel B Trigger Lights, which are driven by a transistor array (U3) on A4.

8-95. A4 Input Amplifiers

8-96. A4 contains two essentially identical amplifier channels. The only differences are: 1.) the Low frequency and High frequency amplifiers have separate inputs for Channel A and are connected together for Channel B; 2.) Channel B has one additional output stage which drives the EXTERNAL ARM line. For simplification, only Channel A will be described.

8-97. The amplifier provides separate Low and High frequency buffer amplifiers. The Low frequency path is through a dual FET in a totem-pole configuration made up of Q4A, B, and associated circuitry. The High frequency buffer amplifier comprising of C8, C12, C18, R14, R15, R16, and Q3 is a simple ac coupled emitter-follower with dc biasing. Its output is combined with a Low frequency amplifier and applied to one side of comparator U2. The dc level from the Trigger Level control is applied to the other input. The complementary ECL outputs of the comparator are input to a differential amplifier, within transistor array U1. The differential amplifier shift the level of the Channel A signal, to the logic level of $\sim +2.4$ V (logic Low), to +3.0V (logic High) required by the MRC.

8-98. An additional differential pair, within U3, forms a one-shot. This circuit monitors the complementary outputs of U2, and drives the Trigger Lights on A3, causing the one-shot to trigger and the LED to flash. CR1 keeps U3 from saturating, which allows it to capture narrow pulses from the comparator. When the outputs of U2 are a steady logic state (High or Low), the LED's will stay fully on or off depending on whether the input signal's dc level is above or below the trigger level.

8-99. A3/A4 Input Amplifier Troubleshooting

NOTE

The Channel A and B Trigger Levels are routed through the A6 Digital-to-Analog Converter, then back to A3. To troubleshoot A3 and A4 disconnect A3P1, and connect a jumper between A3P1 pins 1 and 2 and between pins 3 and 4. This removes the DAC from the circuit. Special shorting clips for this purpose are available by ordering HP Part Number 1258-0141 (2 required).

8-100. To troubleshoot the A3/A4 Input Amplifiers, apply a 10 MHz signal at 25 mV rms (70 mV p-p) to Input A, with the 5316A in COM A. Referring to the A3/A4 schematic diagram, *Figure 8-7*, check that the proper waveforms exist at each channel output (test points A5 and B5) as shown in the following examples. If either is not present, use the example waveforms to trace the signal back through each respective stage.

TEST POINT:

- A1 Channel A signal conditioning output A4Q4(7)
- A2 Channel A Schmitt trigger input A4U2(7)
- A3 Channel A Schmitt trigger output A4U2(1)
- A4 Channel A trigger amplifier one-shot input A4U3(2)
- A5 Channel A to MRC P2(5)

- B1 Channel B signal conditioning output A4Q2(7)
- B2 Channel B Schmitt trigger input A4U2(10)
- B3 Channel B Schmitt trigger output A4U2(16)
- B4 Channel B trigger amplifier one-shot input A4U3(6)
- B5 Channel B to MRC P2(6)
- B6 Channel B arm P2(7)

After the repair, perform the A3 Trigger Level Compensation Adjustments and A4 Input Offset Adjustments as described in paragraphs 5-10 and 5-16, respectively, in Section V.

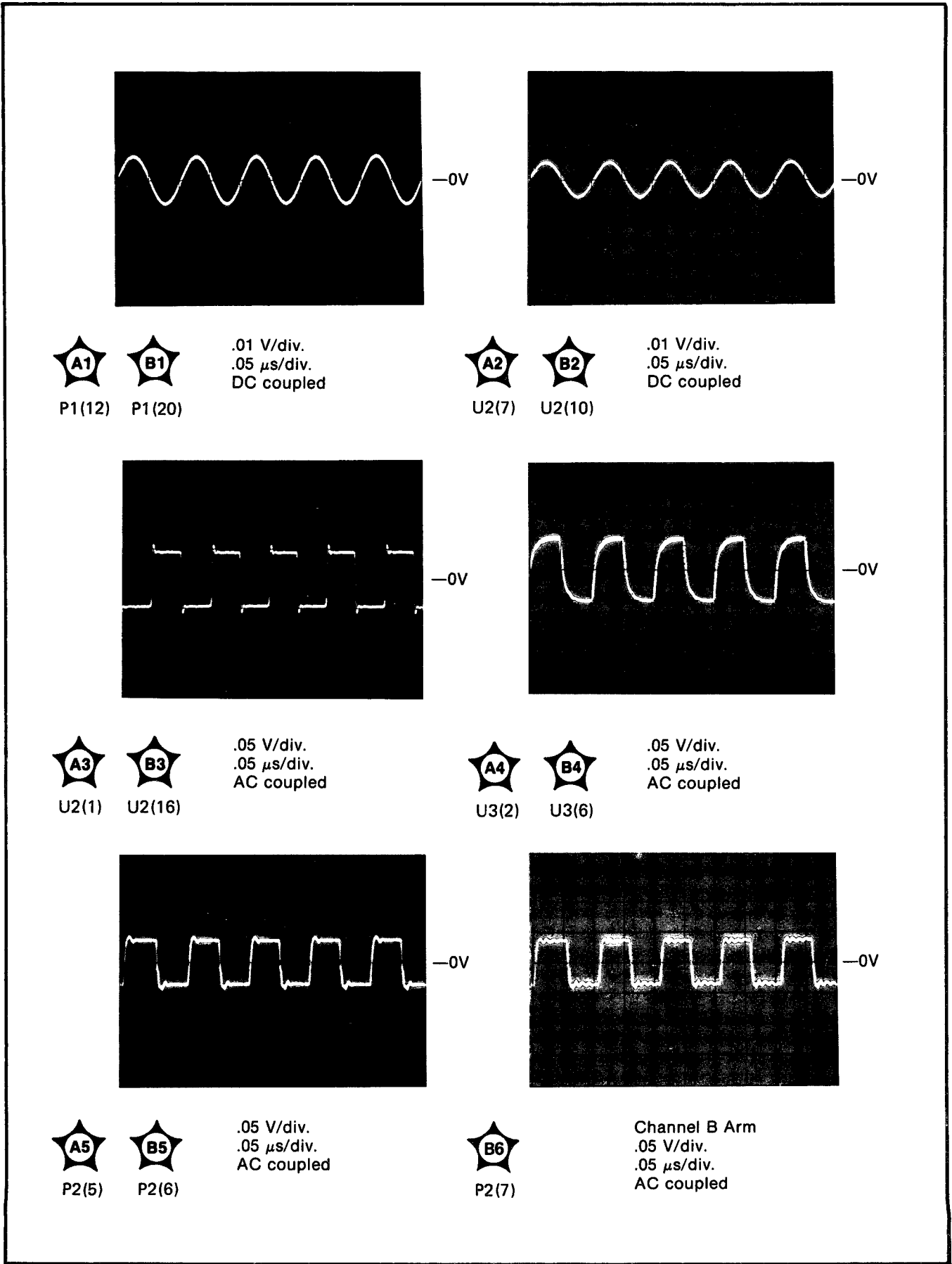

Part of Figure 8-6. A3/A4 Input Assembly

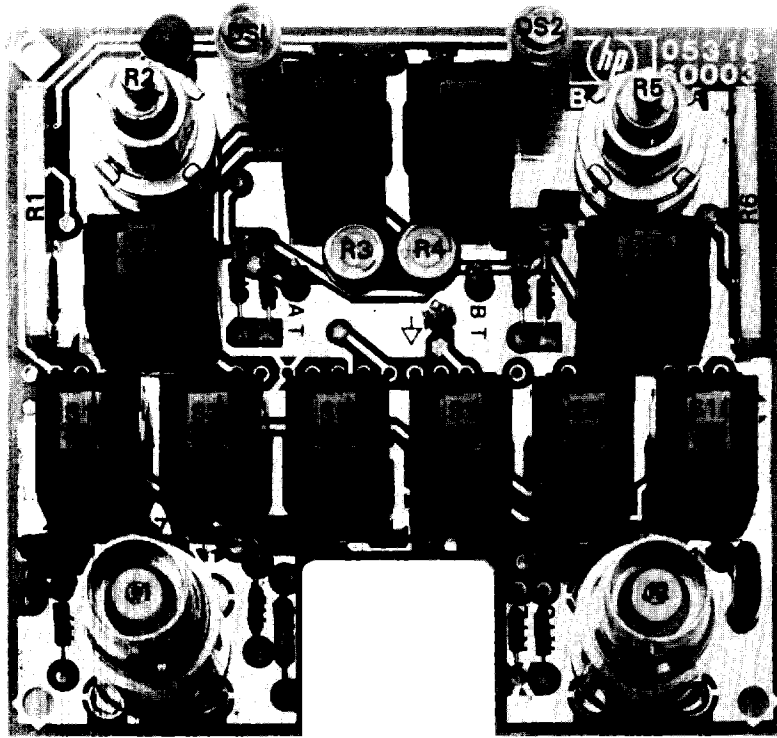

A3

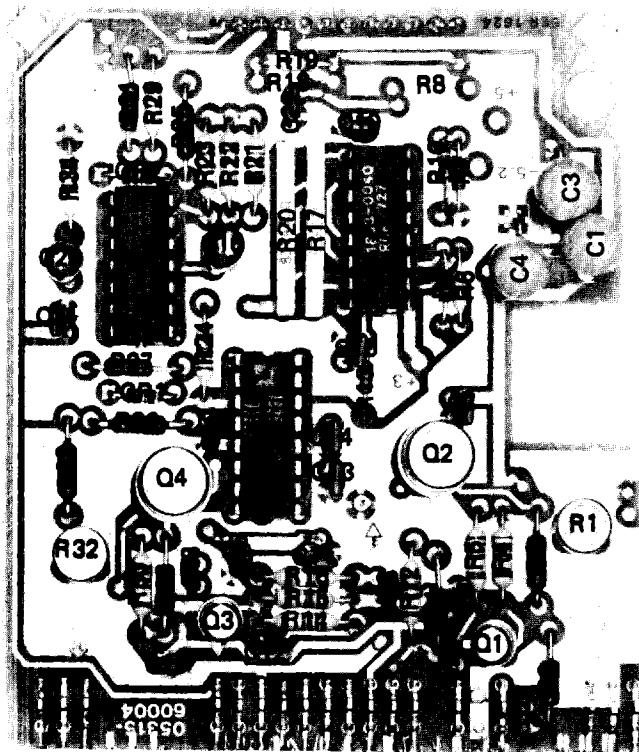

A4

Part of Figure 8-6. A3/A4 Input Assembly

A9 CHANNEL C ASSEMBLY

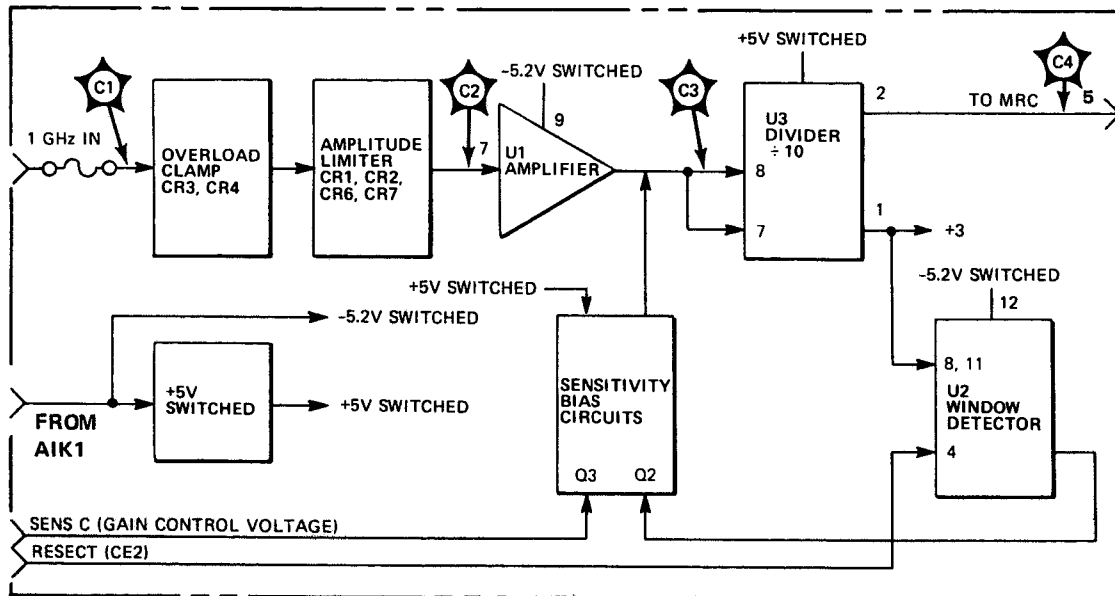

8-101. A9 CHANNEL C THEORY OF OPERATION

8-102. The A9 Channel C assembly may be divided into the following sections:

- a. Input amplitude limiting circuit.
- b. Complementary output buffer amplifier.
- c. Divider biasing circuitry.
- d. Complementary output divide-by-three circuit.
- e. Window detect circuit.

8-103. The A9 Channel C assembly contains circuitry, to limit, amplify, and divide-by-10 an input signal from 50 to 1000 MHz. The overall sensitivity of the assembly is controlled by the dc bias applied to the inputs of the divider. This bias voltage can be manually varied via the front panel SENS C (also labelled Channel A LEVEL/SENS). A switch circuit monitors the divider output. If a marginal input signal level causes the divider output to move into a voltage window, this circuit feeds back a control voltage which increases the divider sensitivity. This in turn prevents any erroneous counts from the divider until the input signal is increased.

8-104. All circuits, except the input overload protection, are powered up only when the FREQ C key is pressed and when the SELECT CHANNEL C line goes Low. The overdrive protection circuits are active whenever the 5316A main power is on.

8-105. The input signal enters the front panel BNC J1, passes through fuse F1 and RF coax cable W1 to the A9 assembly. Input signals $>\pm 5V$ will forward bias the overload protection diodes CR3 and CR4, and the resultant current flow through the diodes will open the 125 mA fuse F1. The signal is ac coupled through C1, to the amplitude limiter circuit comprised of diodes CR1, CR2, CR6, and CR7, and associated circuitry. This circuit protects the differential amplifier in the following stages by limiting the amplitude of the input signal to ± 300 mV maximum. CR1, CR2, CR6, and CR7 are fast switching Schottky diodes, in a balanced bridge configuration. R2 and R4 limit the current, while L1 and L2 and associated capacitors effectively isolate the limiter from power supply noise and transients. The signal is routed through C9 to differential amplifier U1. The input on pins 7 and 5 are balanced through 51.1 ohm resistors, R3 and R5, which provide a dc path to ground. The differential outputs of U1 (pins 1 and 2) are terminated to +5V through resistors R7 and R8. The outputs of U1 drive pins 7, 8,

and 9 of divider U3. The divider is a biquinary (divide-by-2 and divide-by-5) resulting in a division by 10. The sensitivity of U3 is controlled by the differential dc voltage on pins 7 and 8. This dc voltage is controlled by FET Q3. The gate of Q3 is driven through R20 by the SCV (Sensitivity Control Voltage) line from the 5316A front panel SENS C control. U3, pins 7 and 8 are normally offset approximately 75 mV, by HY adjustment R14 and H adjustment R9. Pin 9 is set halfway between TPB1 and TPB2 (approximately 37.5 mV above TP2) by CL adjustment R16. The SCV line swings between approximately +5V and -5V. The Channel C is most sensitive with SCV at +5V, which turns Q3 on hard. As the SCV voltage decreases, Q3 conducts less, dropping more voltage, and increasing the 75 mV offset, which decreases the divider sensitivity. The coupling capacitors C13, C14, and C15 isolate the dc levels of U1 from the dc bias levels of U3. The signal is shaped, squared, divided by 10, and output from U3 at pin 2. Pull-up resistor R17 references the output to +3V to match the 5316A MRC input level requirements.

8-106. The sensitivity switch circuit consisting of U2, Q2, and associated components prevents ambiguity in Channel C when the input signal has marginal strength. Adjustment of R14 is made such that TPB1 and TPB2 are biased to be 110 mV apart (differential), with the SCV line at +5V. At the beginning of each measurement cycle a reset pulse (positive TTL) is applied to U2 pin 4. This pulse causes pin 2 of U2 to pull the gate of FET Q2 to -5.2V, causing Q2 to shut off. Approximately 80 ms after the reset pulse the 5316A MRC begins measurement of the A9 Channel C assembly output. If there is insufficient input signal, there will be no change of state on the outputs of U3 (pins 1 and 2), and the filtered voltage on pin 1 (U3) will be either 2 volts or 3 volts depending on the logical state of the U3 output. In either case this voltage is outside of the "window" of input voltages to U2 (pins 8 and 11) that could cause U2 to turn on (window = 2.4V to 2.8V). However, if the input signal is marginal but is sufficient to cause U3 to change states, the filtered voltage on pin 1, U3 will move into the window of U2. FET Q2 will turn on and the differential dc bias on TPB1 and TPB2 will decrease to 75 mV, as set by adjustment of R9. The sensitivity of U3 will increase by a small amount, such that the input signal strength which was marginal becomes adequate for a correct count. If the input strength drops below this level it will not be sufficient to trigger the hysteresis switch after the next pulse, and the Channel C will drop out.

8-107. Channel C Troubleshooting

8-108. The Channel A and B Input Amplifiers (A3/A4) must be removed to access the A9 Channel C assembly. Refer to Section V, paragraph 5-26, A9 Option 003 Channel C Adjustment, and perform steps a. through t. Once the repair is completed, perform steps a. through t. in reverse order.

8-109. Refer to paragraph 3-70 and check for a blown input fuse. If so, replace the fuse and apply a 100 MHz signal at 100 mV rms to the Channel C Input BNC. Press **FREQ C** and set the **SENS C** (Channel A SENS/LEVEL) control fully clockwise. If the 5316A fails to count the input, the following procedure should help determine the defective stage. If the Channel C input has low sensitivity, there is a possibility that the protection diodes, CR3 and CR4, are damaged and must be replaced. Although when over-powered the input fuse will blow, damage to the junctions of the protection diodes may occur.

8-110. Press **FREQ C**. Verify +5 volts is present at U2 pin 3, and -5.2V is present at U2 pin 12. If NEITHER is present, verify -5.2 volts present at P1 pin 4. The -5.2V SWITCHED is used to turn on Q1, providing +5 volts. If -5.2 volts is NOT present at P1 pin 4 then A1K1 is not being energized or a trace is broken. If it appears A1K1 is not being energized, verify that the CHAN C SWITCH line is going Low at A1U10 pin 11 (6801). Then verify the SELECT CHANNEL C line is going Low at A1U8 pin 12. This line energizes A1K1 removing the -5.2 volt supply from the A3/A4 assembly and applying it to the A9 assembly.

8-111. If both supplies are present, apply a 100 MHz sine wave at 100 mV rms (~280 mV p-p) to INPUT C with the 5316A in **FREQ C** mode. Place the **SENS C** front panel control to **MAX**. Refer to the A9 schematic diagram, *Figure 8-10*, and check that the proper waveforms exist at the indicated points. If the waveforms are not present, trace the signal to the defective stage.

LIMITER INPUT

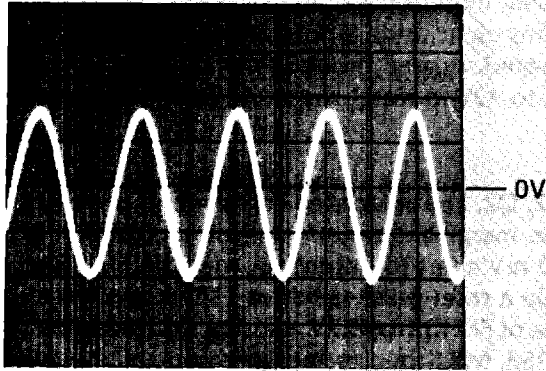

C1
A4CR3 (anode)
V = 0.1V/cm
H = 5 μ s/cm
DC Coupled

LIMITER OUT

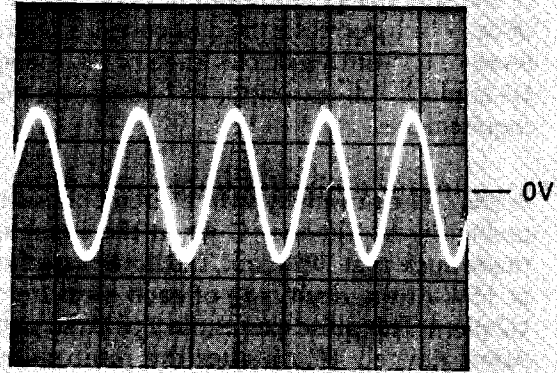

C2
A9U1(7)
V = 0.1V/cm
H = 5 μ s/cm
AC Coupled

INPUT $\div 10$

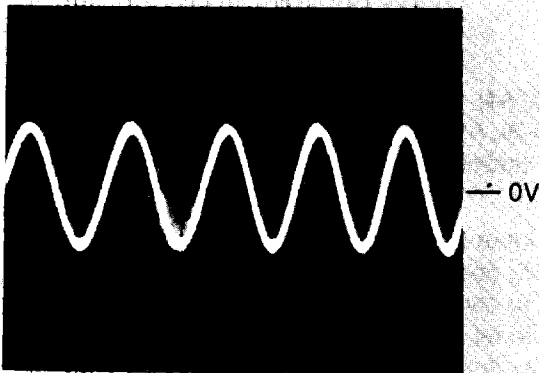

C3
U3(8)
V = 0.1V/cm
H = 5 μ s/cm
AC Coupled

OUTPUT

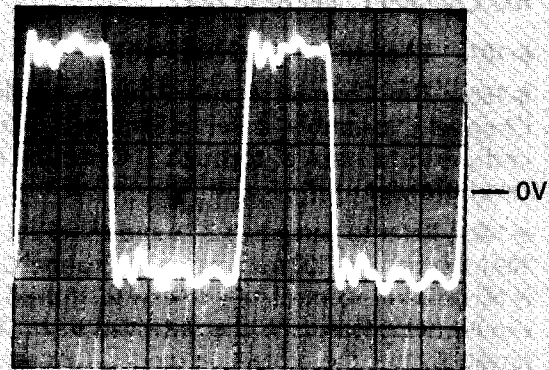

C4
U3(2)
V = 0.2V/cm
H = 20 ns/cm
AC Coupled

Part of Figure 8-7. Option 003 A9 Channel C Assembly

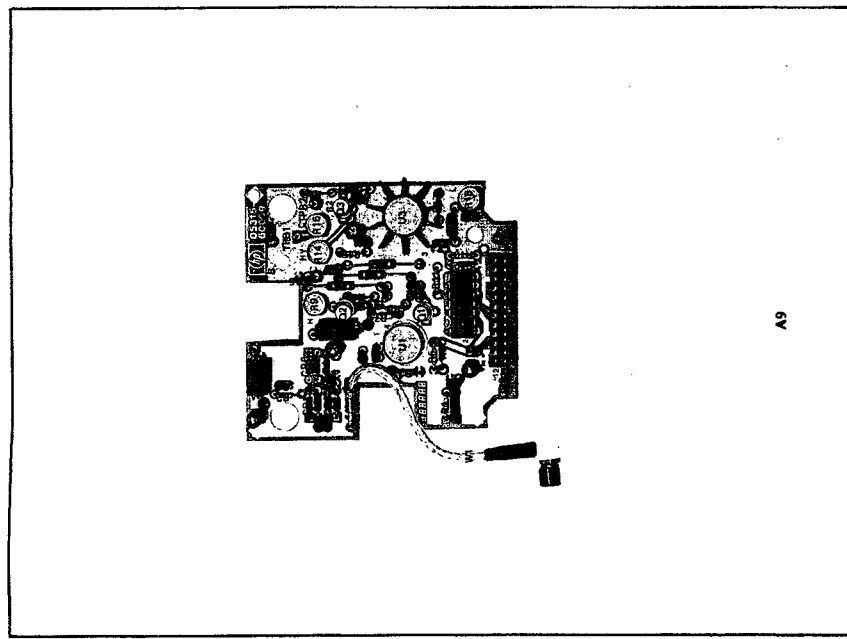

Part of Figure 8-3. A9 Channel C Assembly

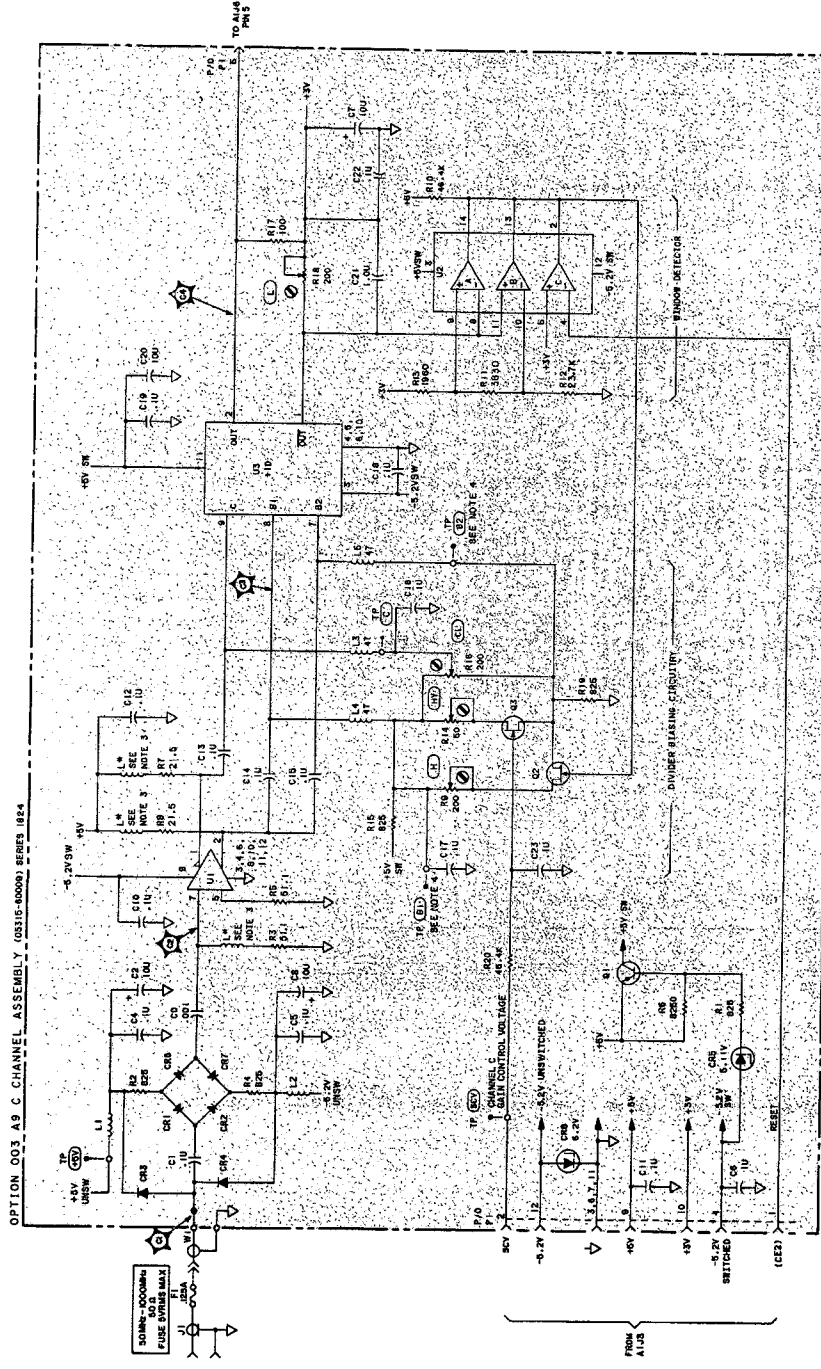

- NOTES
1. REFERENCE DESIGNATIONS WITHIN THIS ASSEMBLY ARE INDICATED, AND ASSOCIATED PART NUMBERS ARE LISTED FOR COMPLETE DESCRIPTION.
 2. UNLESS OTHERWISE INDICATED, RESISTANCE IN OHMS CAPACITANCE IN MICROFARADS DIMENSIONS IN MILLIMETERS
 3. L.W. - IMPEDANCE SHOWN IS NOT A NOMINAL VALUE. IT IS THE VALUE OF THE INTERNALLY LEAD-THEWED LEADS OF ASSOCIATED RESISTOR.
 4. THE DIFFERENTIAL READING (B1-B2) IS 100mV WITH NO SIGNAL APPLIED. APPLY WITH SIGNAL (AT SUFFICIENT LEVEL) USED ONLY IN INSTRUMENTS WITH SERIAL PREFIX 1824A AND EARLIER.

REFERENCE DESIGNATIONS

C1, C2, C4 - C20
R1 - R17
U1 - U2
L1 - L5

TABLE OF ACTIVE COMPONENTS

REFERENCE DESIGNATIONS	PART NUMBER
C1, 2, 5, 7	1901 - 0035
C3, 4	1901 - 0050
C8	1802 - 0041
C9	1802 - 0051
Q1	1855 - 0291
Q2, 3	1855 - 0420
U1	1828 - 0089
U2	1828 - 0128
U3	1828 - 2171

Figure 8-2. A9 Channel C Assembly
8-41

A7 TIME BASE OSCILLATOR ASSEMBLY (STANDARD)

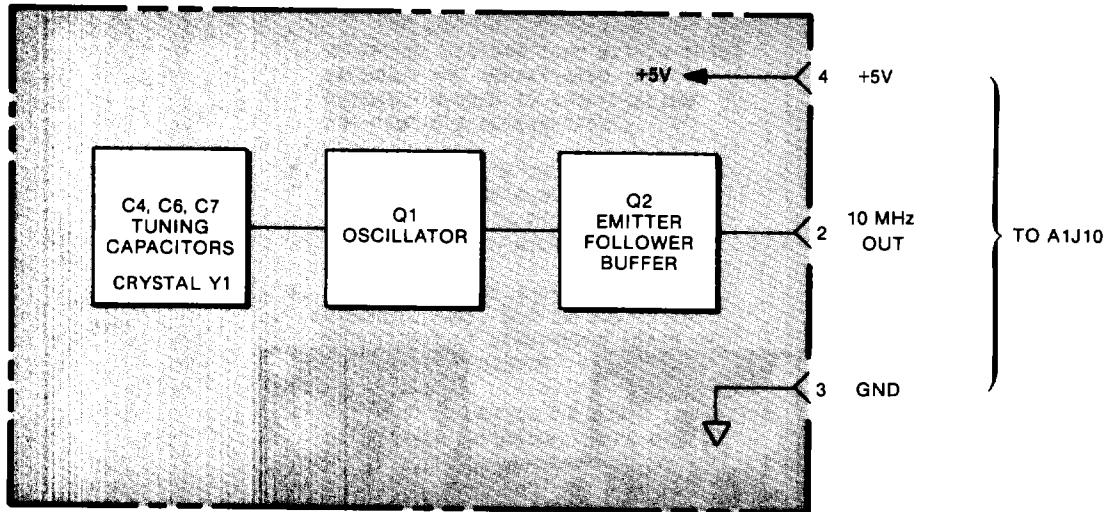

8-112. A7 TIME BASE OSCILLATOR

8-113. The Standard A7 Time Base Oscillator may be divided into the following sections:

- a. Oscillator circuit.
- b. Buffer amplifier.

8-114. The standard time base for the 5316A uses a 10 MHz Quartz Crystal, Y1. The circuit is formed around Q1, and uses feedback through divider C1 and C2. This stage then drives emitter follower Q2. The signal output at pin 2 is routed to S3 on A1. A1S3 selects whether the reference frequency will be derived from the on-board standard time base assembly (or the optional TCXO or Oven Oscillator) or from an external input frequency source connected to J9. An external reference connected to J9 is applied to the injection-lock-multiplier on A1. This circuit allows three different reference frequencies to be used (1, 5, 10 MHz). See A1 Theory of Operation, paragraph 8-75, Injection-Lock Multiplier.

8-115. Option 004 Oven Oscillator

8-116. The Oven Oscillator is made up of two sections: an assembly that replaces the Standard A7 assembly and an Oven Oscillator Module, A13. The A7 assembly is a voltage regulator circuit to supply +5 volts to the oscillator module, A13. The regulator consists of a series transistor Q1, a 2.5-volt reference U2, and amplifier U1. The 2.5V reference is applied to the inverting input of U1 at pin 2. The output of the voltage divider consisting of trimmer R2, R3, and R4 is applied to the noninverting input, pin 3. Since U1 wants to keep both of the inputs at the same voltage (2.5V due to reference U2), the current flowing into the noninverting input will reflect changes in the 5V output. U1 will increase or decrease the drive current to Q1 base as necessary. This changes Q1 emitter-collector voltage drop, restoring the proper output voltage. Zener diode CR1 provides a voltage shift to set Q1 base at the required 7.0V. Trimmer R2 is adjusted to compensate for offsets and tolerances in the components.

8-117. A7 Troubleshooting

8-118. STANDARD OSCILLATOR. To verify proper operation of the oscillator, check for the presence of the 10 MHz sine wave at the emitter of Q2. If the signal is not present, check Q1, Q2, and Y1. The following figures show the output waveforms for the standard oscillator and the Option 001 TCXO.

8-119. OPTION 001 (TCXO). If the 5316A has Option 001 (TCXO) and it has been found to be defective, then it must be replaced since it cannot be repaired.

8-120. OPTION 004 OVEN OSCILLATOR. If the output at A7P1 pin 2, is low or there is no output, verify there is +5V at the collector of Q1, (heat sink tab). If +5V is present, then the oscillator module is defective and must be replaced. It is not repairable.

8-121. If +5V is not present (0V or low), verify there is +2.5V at U2 pin 2. The output of U1 at pin 6 should be $\sim 4.2V$. If Q1 were to short emitter to collector, this would place 3.75V to the noninverting input of U1 at pin 3, probably damaging U1. Since R5 will limit the current from U2, U2 is subject mainly to internal failures.

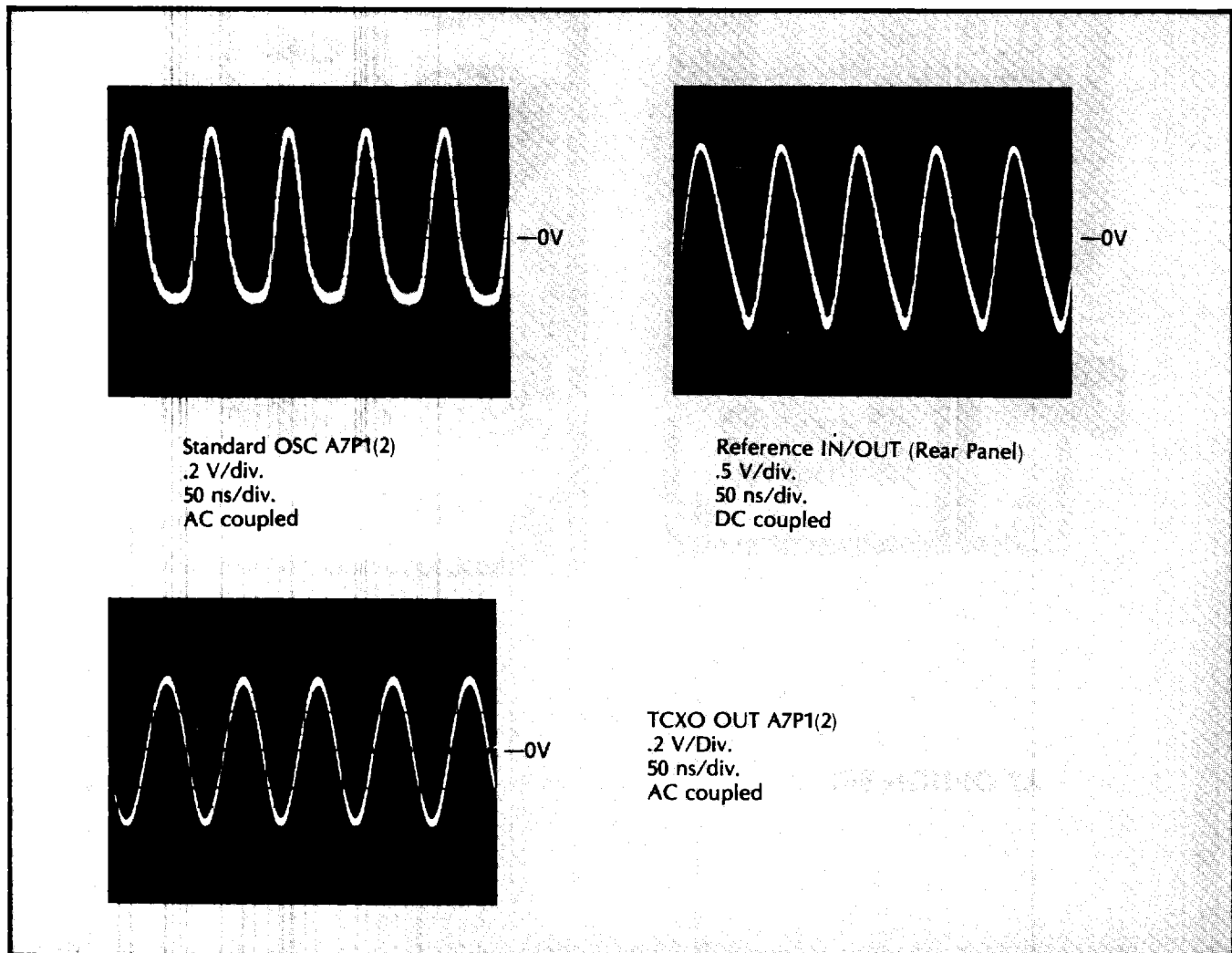

Part of Figure 8-8. A7 Reference Assembly

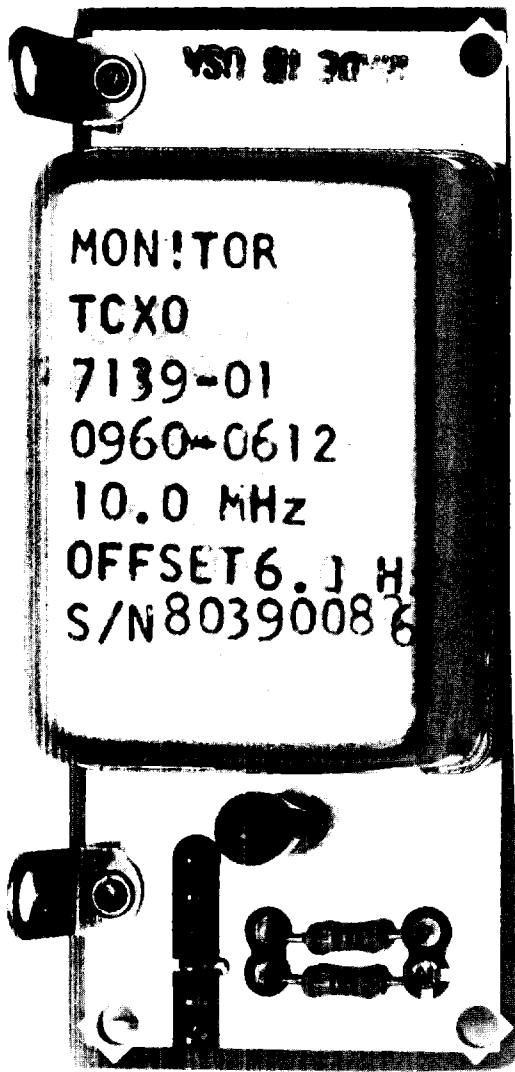

A7 OPTION 001

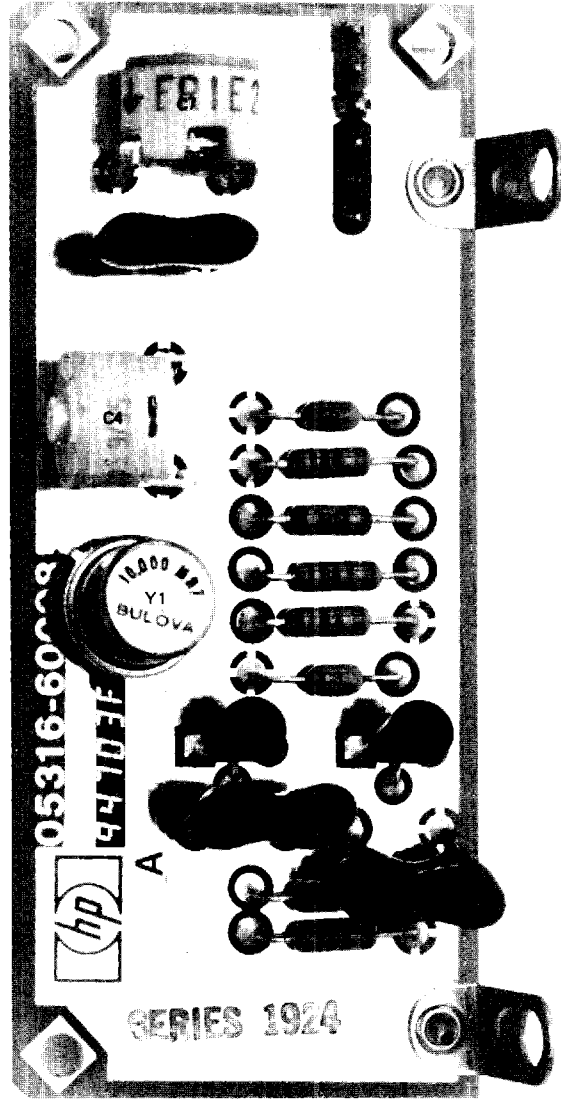

A7 STANDARD

Part of Figure 8-8. A7 Reference Assembly

- NOTES:
1. REFERENCE DESIGNATIONS WITHIN THIS ASSEMBLY ARE ABBREVIATED. ADD COMPLETE DESCRIPTION FOR COMPLETE DESCRIPTION.
 2. UNLESS OTHERWISE INDICATED: RESISTANCE IN OHMS; CAPACITANCE IN MICROFARADS; DIMENSIONS IN INCHES.
 3. ASTERISK (*) INDICATES FACTORY SHOWN.

REFERENCE DESIGNATIONS
(03318-40008)

AT	C1-7
	R1-2

TABLE OF ACTIVE COMPONENTS

REFERENCE DESIGNATION	PART NUMBER
C1-7	03318-40008
R1-2	03318-40008

REFERENCE DESIGNATIONS
(03318-40007)

TCXD	001
R1,2	Y1

TABLE OF ACTIVE COMPONENTS

REFERENCE DESIGNATION	PART NUMBER
TCXD	03318-40007
R1,2	03318-40007

REFERENCE DESIGNATIONS
(03318-40013)

C1-4	C1
	R1-4
	U1,2

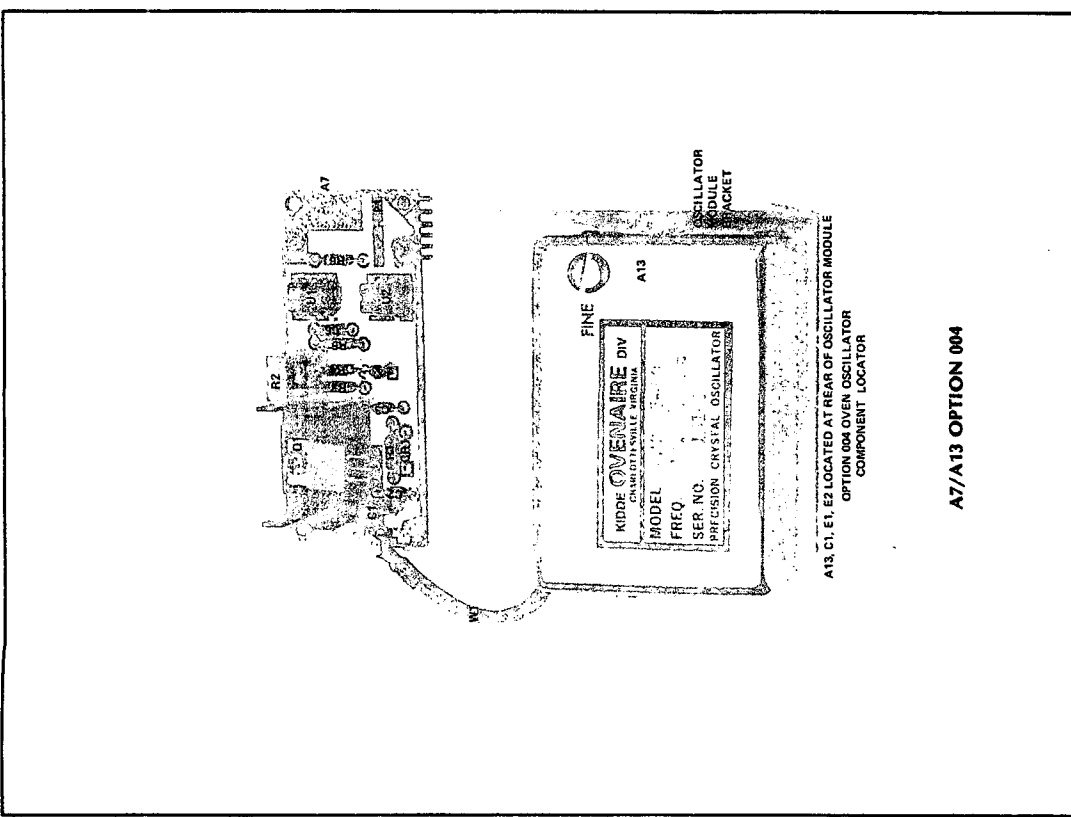
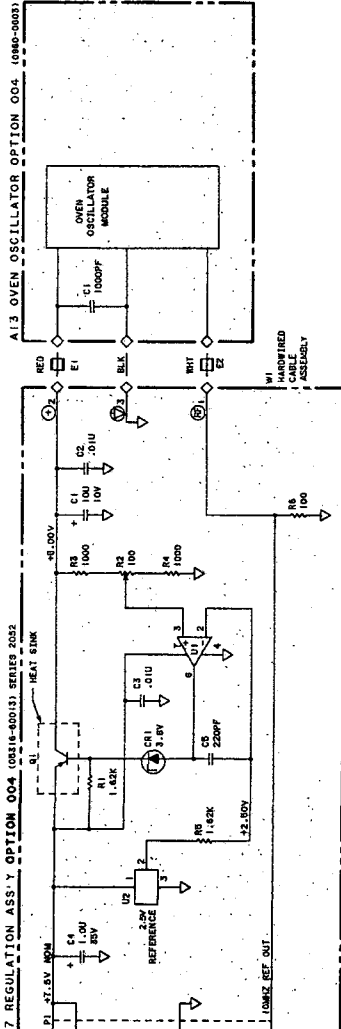
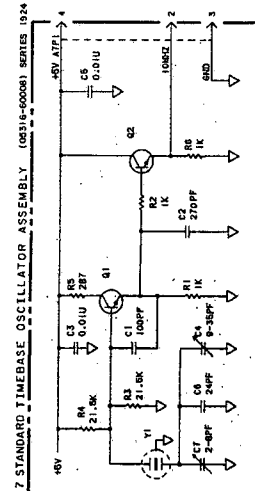
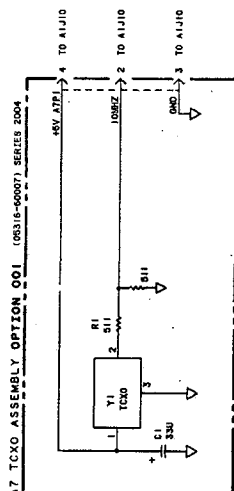

Part of Figure 8-8. A7 Reference Assembly

Figure 8-8. A7 Time Base Assemblies
8-45

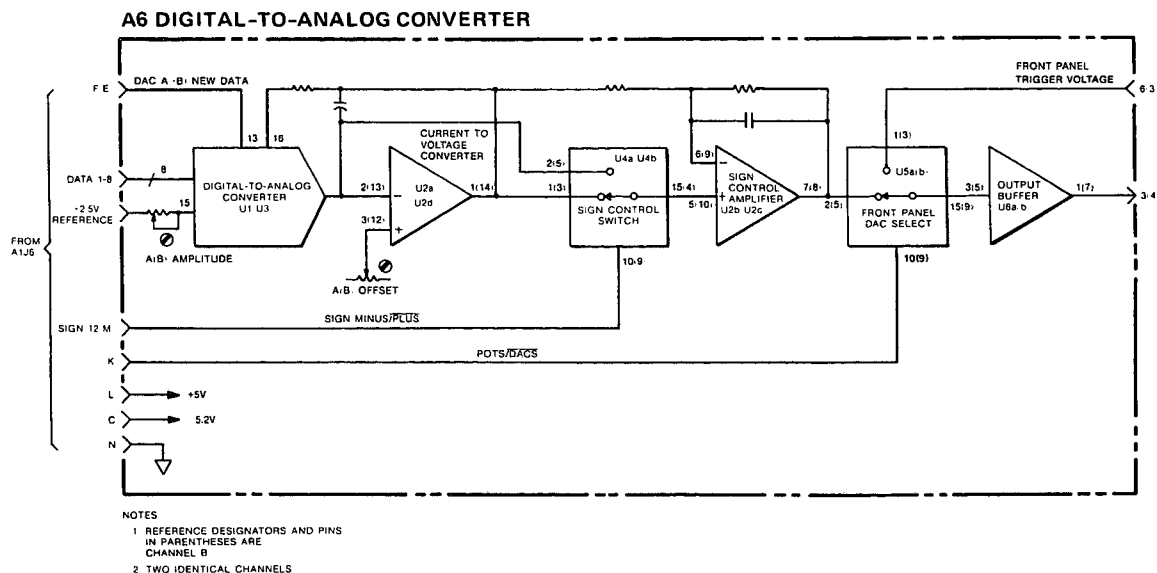

8-122. A6 DIGITAL-TO-ANALOG CONVERTER

8-123. The A6 Digital-to-Analog Converter may be divided into the following sections:

- DAC current-to-voltage converter.
- Polarity inverting stage.
- Polarity select analog switch.
- DAC assembly buffer output stage.
- Analog switch to select DAC or front panel trigger level controls.

8-124. The Digital-to-Analog Converter assembly controls the trigger level circuitry, allowing the 6801 to select Local or Remote Trigger Level control, and to set the value of the trigger level voltage when it is being controlled remotely.

8-125. The assembly has two identical circuits, one for the Channel A and one for the Channel B. The following description is for the Channel A. The Channel B is identical.

8-126. The variable voltage from the front panel trigger level control on A3 goes either to the 6-pin connector on the rear of the assembly (when the Trigger Level/Sensitivity switch is in the Trigger Level position) or to the sensitivity control network on A4.

8-127. A five-conductor cable takes the voltage from the trigger level control, through connector P2, to one of the inputs of a triple SPDT CMOS analog multiplexer, U5A. The control line (pin 10 of U5A), determines whether this voltage, or the voltage from the Digital-to-Analog Converter, will be routed back to the input amplifier assembly to be used as the trigger level voltage. The control line is driven by U8 pin 2 of a CMOS 6-bit latch on the A1 Motherboard. U8 latches data from 6801, port 1, by a pulse on "LATCH MISC FUNC".

8-128. TRIGGER LEVEL POTS/DACS initializes (during power-up and when the IN instruction has been received) in the high state, so that the trigger level is set by the front panel trigger level controls. When a TR1 instruction is received, the control line goes Low, connecting the trigger level lines to the outputs of the Digital-to-Analog Converters for remote setting of the trigger levels. A TR0 command will return control back to the front panel trigger level controls by setting the control line High.

8-129. The A6 Digital-to-Analog Converter assembly consists of three major blocks: the D/A Converter U1, Current-to-Voltage Converter U2A, and Sign Control Amplifier U2B.

8-130. The D/A Converters are 8-bit CMOS circuits with an internal data latch and current mode output. Data is clocked into the latch on the rising edge of the "DAC A NEW DATA" pulse derived from the A1 Motherboard U11 pin 12 and pin 13 (Channel A or B). The data bits come from Port 1 of the 6801. When it is necessary to change the trigger level, the 6801 will remove the current data from the port and store it internally. (Port 1 of the 6801 is shared between several circuits; thus it is necessary for the 6801 to store the current data at Port 1 whenever it is requested to send new data to a different circuit. Once the data has been sent and received by the other circuit, the original data is returned to Port 1 so it can continue its original function.) The 6801 will place the new 8-bit data representing the new trigger level voltage at Port 1. The 6801 will then follow with a pulse on the "DAC A NEW DATA" line to latch this data into the DAC U1. Once this is accomplished, the 6801 will remove the 8-bit data from Port 1 and replace it with the original data present before the 6801 was ordered to send the DAC data. A similar process sets the Channel B DAC, U3.

8-131. The DAC reference current is defined by the +2.5V reference located on the A1 Motherboard. This reference is passed through R1 to the DAC.

8-132. The output of the DAC is fed to the inverting input of U2A. U2A has a feedback path through R15 to U1 pin 16. U2A is acting as an inverting current-to-voltage converter, with component values selected so that each bit represents a 10 mV change in the output of U2A. U2A output ranges from 0 to -2.55V. To obtain a negative trigger voltage, the output of U2A is fed to U2B. In this configuration, U2B is acting as a summing differential amplifier. For any voltage at the output of U2A, the voltage applied to the inverting input of U2B will have a gain of $-(R5/R6)$ or -1. For any voltage at the output of U2A, the voltage applied to the noninverting input of U2B will have a gain of $1 + R5/R6 = +2$. Since the same voltage is being applied to both inputs, the resulting output gain is +1 and the output is from 0 to -2.55V.

8-133. To obtain a positive trigger level, U4A connects the noninverting input of U2B directly to the output of the DAC. Since the DAC's output is current, the current through R5 will cause a positive voltage from 0 to +2.55V to appear at the output of U2B.

8-134. R2 offset adjustment is provided to null out the offset voltages of U2A and U2B and voltage buffer U4A.

8-135. U5A selects either the front panel trigger voltage set by A3R2 or the output of A6U2B, whenever the "POTS/DACS" line goes Low. U6A acts as a voltage follower to buffer the A6 output voltage and provide a low output impedance necessary to drive the 1K ohm resistor on the A3 assembly.

8-136. A6 Digital-to-Analog Converter Troubleshooting

8-137. The following A6 troubleshooting assumes the 5316A will pass Checkpoint 1 of the HP-IB Verification in Section IV and that the failure of the A6 assembly to program trigger levels is not due to a failure in the HP-IB portion of the A1 Motherboard.

8-138. Connect a DVM to the front panel Trigger Level Out jacks. Set Channel A and B Trigger Level/Sensitivity switches to the TRIGGER LEVEL position (OUT). Vary the A and B Trigger Level controls and verify the DVM displays approximately -2.50V to +2.50V. This verifies that cable W2 is connected from the A3 assembly to the A6 assembly, the front panel TRIGGER LEVEL OUT jacks are connected to the front panel, and the analog switches (U5) on the A6 assembly are selecting the front panel controls.

8-139. Connect, through a 10:1 probe, an oscilloscope to the Channel A front panel TRIGGER LEVEL OUT on the front panel. Set the oscilloscope to:

.1 volt/div. .05 s/div. dc coupled + slope

8-140. Ground TP3 on the A1 Motherboard. This places the 5316A in the signature analysis mode. The display will flicker (see paragraph 8-70, step 4.) The A6 Digital-to-Analog Converter is now being programmed to increment through its full voltage range. *Figure 1, 2, and 3* show the output of U2 at pins 1(14) and 7(8), and the front panel TRIGGER LEVEL OUT. Both A and B Channels should be the same.

8-141. If the sawtooth wave is not present at U2 pins 1 and 14, verify U5 pins 9 and 10 are Low. This is the POTS/DACS line which selects the front panel controls when High or the D/A when Low. If the POTS/DACS line is High, connect U5 pins 9 and 10 to ground for a short time. If the sawtooth wave is now present, then the problem is associated with the HP-IB portion of the 5316A. Refer to paragraph 8-45, step g., and follow the procedure to isolate the problem.

8-142. *Figure 4* shows the effect when the HP-IB portion of the 5316A or A6U4 fails to select the proper polarity trigger level. The upper trace is the front panel TRIGGER LEVEL OUT when only negative trigger voltages are being selected. The lower trace is when only positive trigger voltages are being selected. U4 pins 9 and 10 should have square wave present during this ramp test. This indicates the HP-IB portion of the 5316A is switching between positive and negative trigger levels. If this signal is not present (latched High or Low) then the HP-IB portion is defective. Refer to paragraph 8-45, step g., and following the procedure to isolate the problem.

8-143. If the AOS and BOS controls appear ineffective during adjustment of the A6 assembly suspect U1 or U3 D/A Converters or U2 voltage-to-current converters. If the offset controls have an effect but do not have the necessary range, then suspect U1 or U3 D/A converters.

8-144. If the A AMP and B AMP controls appear ineffective during adjustment, then suspect U1 or U3. If the controls have an effect but do not have the necessary range, AND 2.5V is present at U1 and U3 pin 15, then suspect U1 or U3.

NOTE

After repair, adjust the A6 assembly as described in Section V, paragraph 5-14.

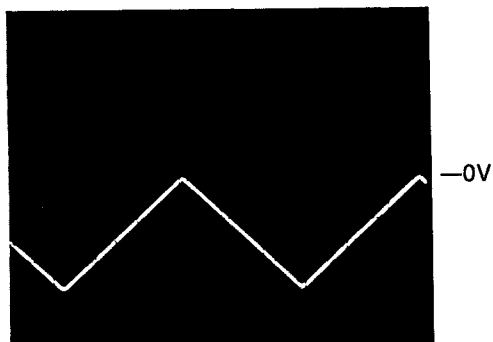

Figure 1



U2 Pin 1
.1 V/div.
.05 s/div.
DC coupled

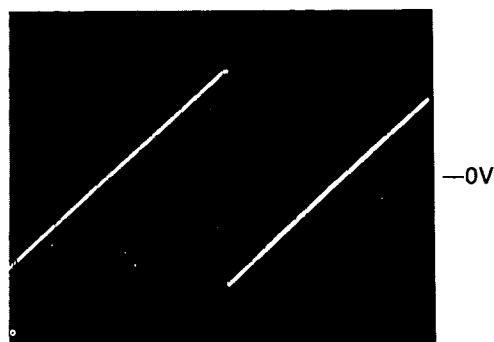

Figure 2



U2 Pin 7
.1 V/div.
.05 s/div.
DC coupled

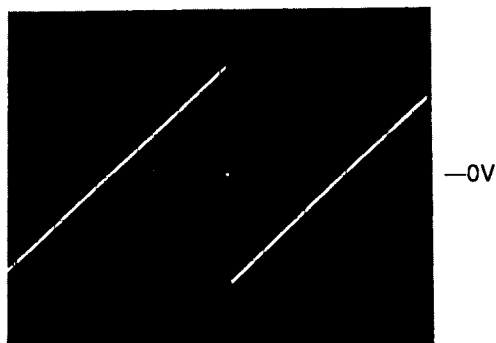

Figure 3



Trigger Level Out
.1 V/div.
.05 s/div.
DC coupled

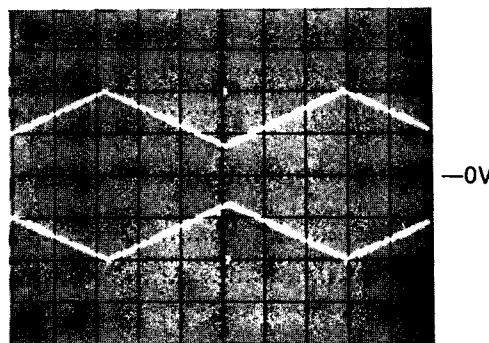
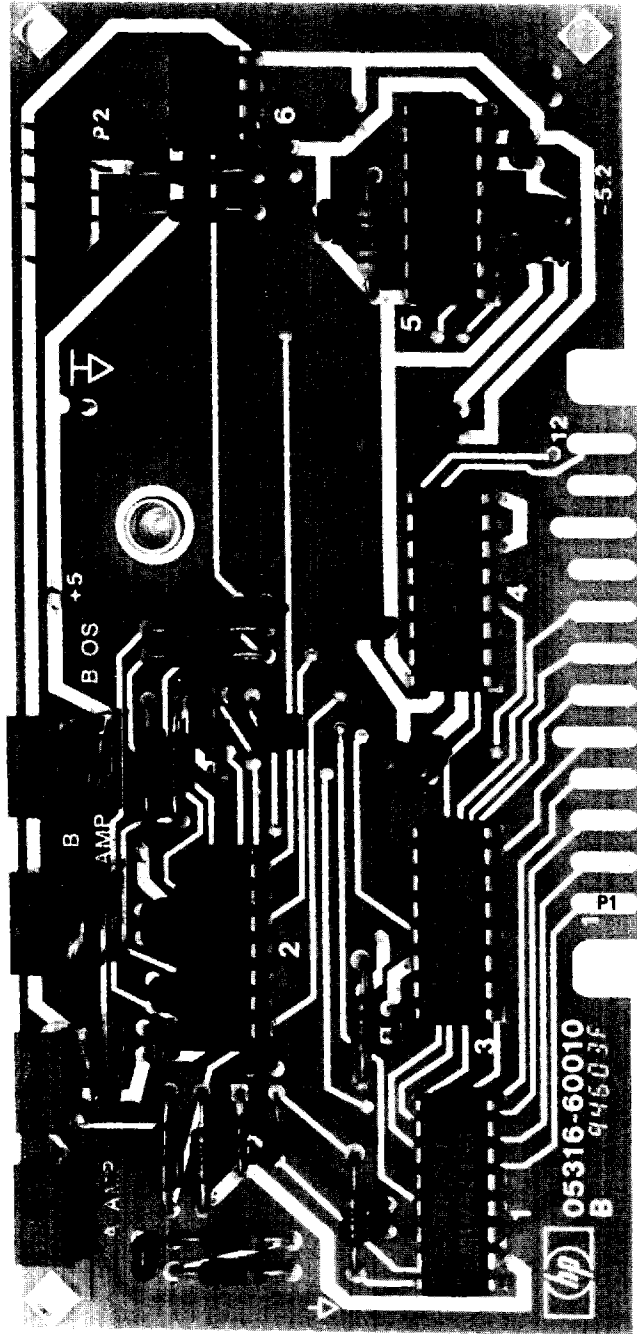

Figure 4

Front Panel
Trigger Level Out
.2 V/div.
.05 s/div.
DC coupled



A6

Part of Figure 8-9. A6 Digital-to-Analog Converter Assembly

- NOTES:
1. SERVICE DESIGNERS MUST REFER THIS ASSEMBLY AND INDICATED PART NUMBER TO INTERPRETATION FOR COMPLETE DESCRIPTION.
 2. UNLESS OTHERWISE SPECIFIED, RESISTANCE IN OHMS.
 3. CAPACITANCE IN FARADS.
 4. RESISTANCE IN KILOHMS.
 5. RESISTANCE IN MEGOHMS.
 6. RESISTANCE IN GIGAOHMS.
 7. RESISTANCE IN PERCENT.
 8. RESISTANCE VALUE SHOWN.

REFERENCE DESIGNATIONS:

C1, C2, C3, C4, C5, C6, C7, C8, C9, C10, C11, C12, C13, C14, C15, C16, C17, C18, C19, C20, C21, C22, C23, C24, C25, C26, C27, C28, C29, C30, C31, C32, C33, C34, C35, C36, C37, C38, C39, C40, C41, C42, C43, C44, C45, C46, C47, C48, C49, C50, C51, C52, C53, C54, C55, C56, C57, C58, C59, C60, C61, C62, C63, C64, C65, C66, C67, C68, C69, C70, C71, C72, C73, C74, C75, C76, C77, C78, C79, C80, C81, C82, C83, C84, C85, C86, C87, C88, C89, C90, C91, C92, C93, C94, C95, C96, C97, C98, C99, C100	RESISTOR
R1, R2, R3, R4, R5, R6, R7, R8, R9, R10, R11, R12, R13, R14, R15, R16, R17, R18, R19, R20, R21, R22, R23, R24, R25, R26, R27, R28, R29, R30, R31, R32, R33, R34, R35, R36, R37, R38, R39, R40, R41, R42, R43, R44, R45, R46, R47, R48, R49, R50, R51, R52, R53, R54, R55, R56, R57, R58, R59, R60, R61, R62, R63, R64, R65, R66, R67, R68, R69, R70, R71, R72, R73, R74, R75, R76, R77, R78, R79, R80, R81, R82, R83, R84, R85, R86, R87, R88, R89, R90, R91, R92, R93, R94, R95, R96, R97, R98, R99, R100	RESISTOR
U1, U2, U3, U4, U5, U6, U7, U8, U9, U10, U11, U12, U13, U14, U15, U16, U17, U18, U19, U20, U21, U22, U23, U24, U25, U26, U27, U28, U29, U30, U31, U32, U33, U34, U35, U36, U37, U38, U39, U40, U41, U42, U43, U44, U45, U46, U47, U48, U49, U50, U51, U52, U53, U54, U55, U56, U57, U58, U59, U60, U61, U62, U63, U64, U65, U66, U67, U68, U69, U70, U71, U72, U73, U74, U75, U76, U77, U78, U79, U80, U81, U82, U83, U84, U85, U86, U87, U88, U89, U90, U91, U92, U93, U94, U95, U96, U97, U98, U99, U100	IC

TABLE OF ACTIVE COMPONENTS:

REF. DESIGNATION	DESCRIPTION	MANUFACTURER
U1, U2, U3, U4, U5, U6, U7, U8, U9, U10, U11, U12, U13, U14, U15, U16, U17, U18, U19, U20, U21, U22, U23, U24, U25, U26, U27, U28, U29, U30, U31, U32, U33, U34, U35, U36, U37, U38, U39, U40, U41, U42, U43, U44, U45, U46, U47, U48, U49, U50, U51, U52, U53, U54, U55, U56, U57, U58, U59, U60, U61, U62, U63, U64, U65, U66, U67, U68, U69, U70, U71, U72, U73, U74, U75, U76, U77, U78, U79, U80, U81, U82, U83, U84, U85, U86, U87, U88, U89, U90, U91, U92, U93, U94, U95, U96, U97, U98, U99, U100 <td>IC</td> <td>100-00000</td>	IC	100-00000
U1, U2, U3, U4, U5, U6, U7, U8, U9, U10, U11, U12, U13, U14, U15, U16, U17, U18, U19, U20, U21, U22, U23, U24, U25, U26, U27, U28, U29, U30, U31, U32, U33, U34, U35, U36, U37, U38, U39, U40, U41, U42, U43, U44, U45, U46, U47, U48, U49, U50, U51, U52, U53, U54, U55, U56, U57, U58, U59, U60, U61, U62, U63, U64, U65, U66, U67, U68, U69, U70, U71, U72, U73, U74, U75, U76, U77, U78, U79, U80, U81, U82, U83, U84, U85, U86, U87, U88, U89, U90, U91, U92, U93, U94, U95, U96, U97, U98, U99, U100 <td>IC</td> <td>100-00000</td>	IC	100-00000
U1, U2, U3, U4, U5, U6, U7, U8, U9, U10, U11, U12, U13, U14, U15, U16, U17, U18, U19, U20, U21, U22, U23, U24, U25, U26, U27, U28, U29, U30, U31, U32, U33, U34, U35, U36, U37, U38, U39, U40, U41, U42, U43, U44, U45, U46, U47, U48, U49, U50, U51, U52, U53, U54, U55, U56, U57, U58, U59, U60, U61, U62, U63, U64, U65, U66, U67, U68, U69, U70, U71, U72, U73, U74, U75, U76, U77, U78, U79, U80, U81, U82, U83, U84, U85, U86, U87, U88, U89, U90, U91, U92, U93, U94, U95, U96, U97, U98, U99, U100 <td>IC</td> <td>100-00000</td>	IC	100-00000
U1, U2, U3, U4, U5, U6, U7, U8, U9, U10, U11, U12, U13, U14, U15, U16, U17, U18, U19, U20, U21, U22, U23, U24, U25, U26, U27, U28, U29, U30, U31, U32, U33, U34, U35, U36, U37, U38, U39, U40, U41, U42, U43, U44, U45, U46, U47, U48, U49, U50, U51, U52, U53, U54, U55, U56, U57, U58, U59, U60, U61, U62, U63, U64, U65, U66, U67, U68, U69, U70, U71, U72, U73, U74, U75, U76, U77, U78, U79, U80, U81, U82, U83, U84, U85, U86, U87, U88, U89, U90, U91, U92, U93, U94, U95, U96, U97, U98, U99, U100 <td>IC</td> <td>100-00000</td>	IC	100-00000

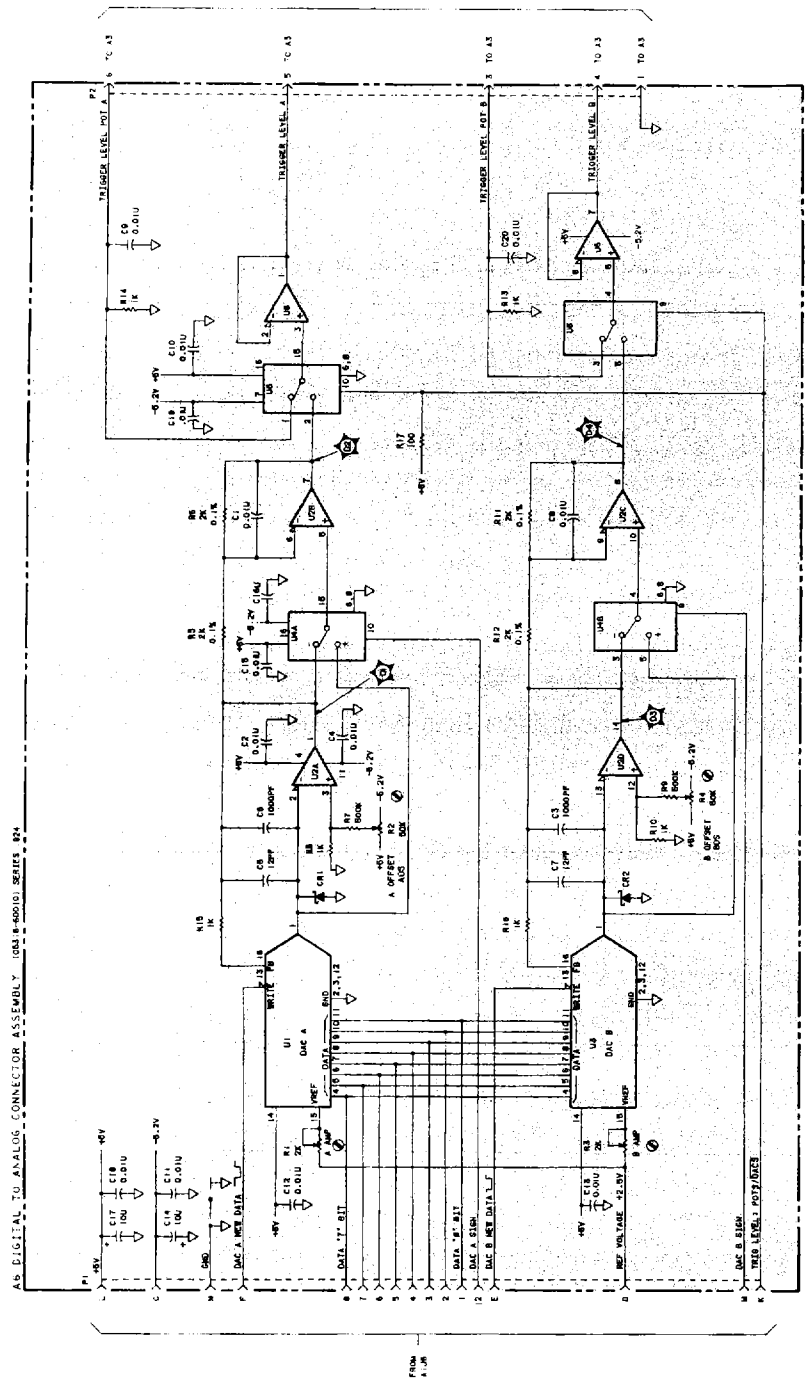
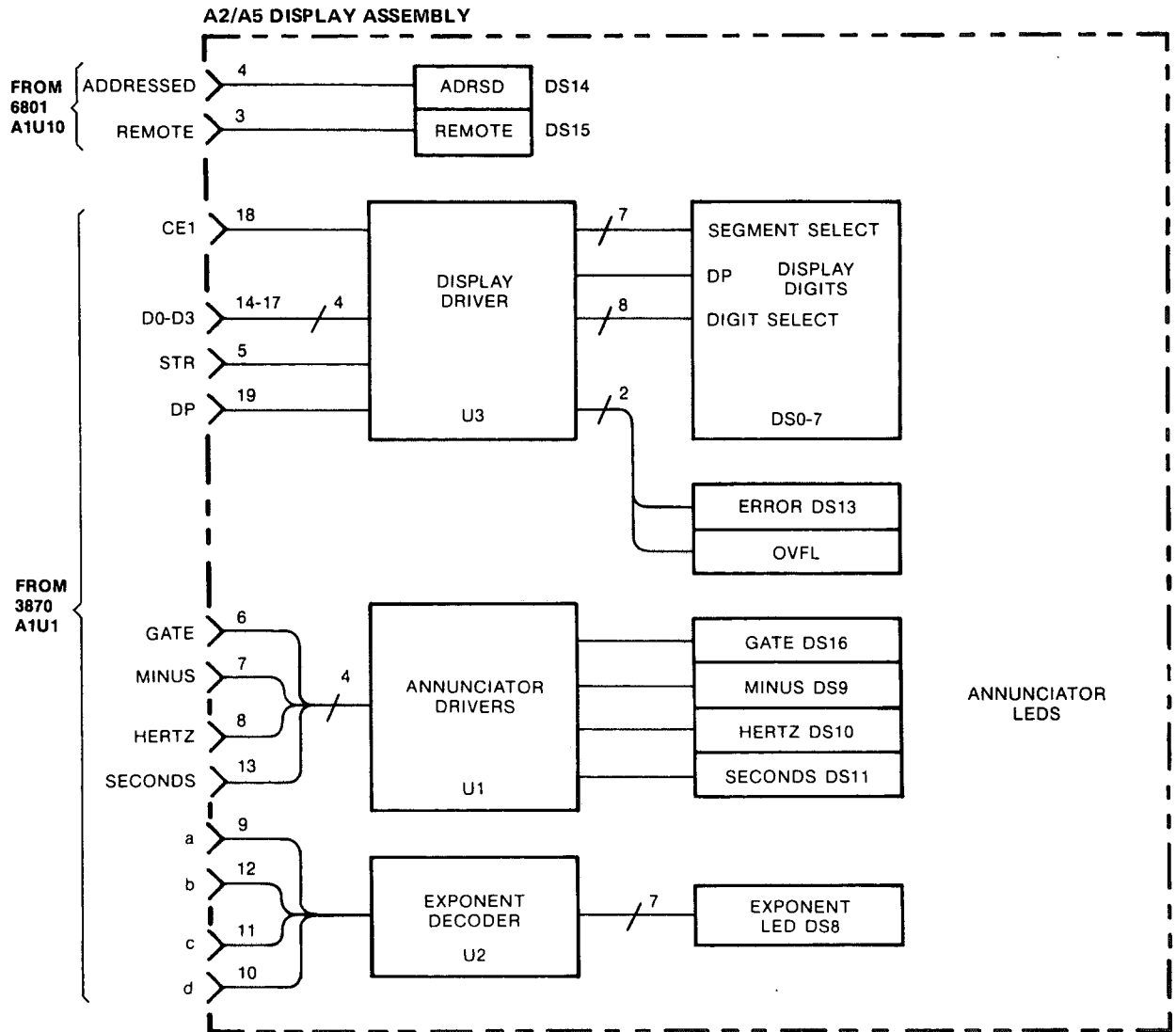

Figure 8-9. A6 Digital-to-Analog Converter Assembly
8-51



8-145. A2/A5 DISPLAY ASSEMBLY

8-146. The A2 Display assembly may be divided into the following sections:

- a. LED digit displays.
- b. Display decoder driver.
- c. Annunciator drivers.
- d. Exponent decoder.
- e. Status and annunciator LEDs.

8-147. The A5 Display Support assembly does not contain any circuitry; it serves only to connect the A2 Display assembly to the A1 Motherboard.

8-148. The Display assembly provides 8 digits of resolution with seven-segment LEDs, D0 through D7. The displays are controlled by display driver U3. The display driver contains complete decoding, memory, and scan circuitry as well as power drivers for the LED's.

- NOTES
1. ELECTRICAL CONNECTIONS WITHIN THIS ASSEMBLY ARE MADE TO CORRELATE WITH THE ELECTRICAL CONNECTIONS SHOWN IN THE WIRING DIAGRAMS OF THIS MANUAL.
 2. PARTS LISTED IN THIS MANUAL ARE SUBJECT TO CHANGE WITHOUT NOTICE.
 3. ACTUAL PARTS IDENTIFICATION SHOULD BE OBTAINED FROM THE PARTS LIST.
 4. COMPONENTS IDENTIFIED AS "ELECTRICAL" ARE NOT TO BE REPAIRED OR REPLACED.

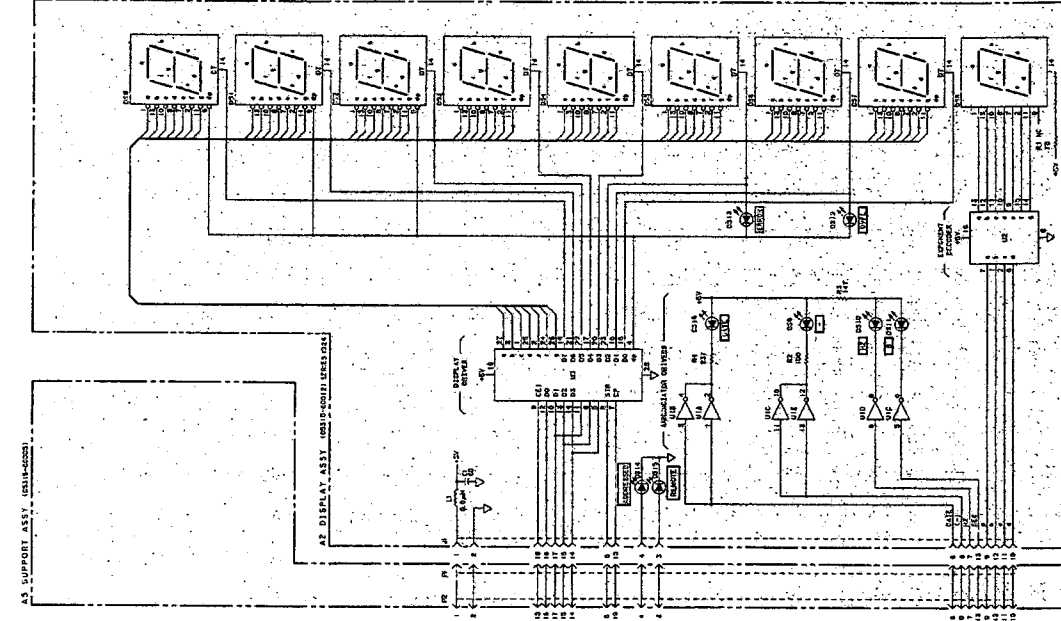
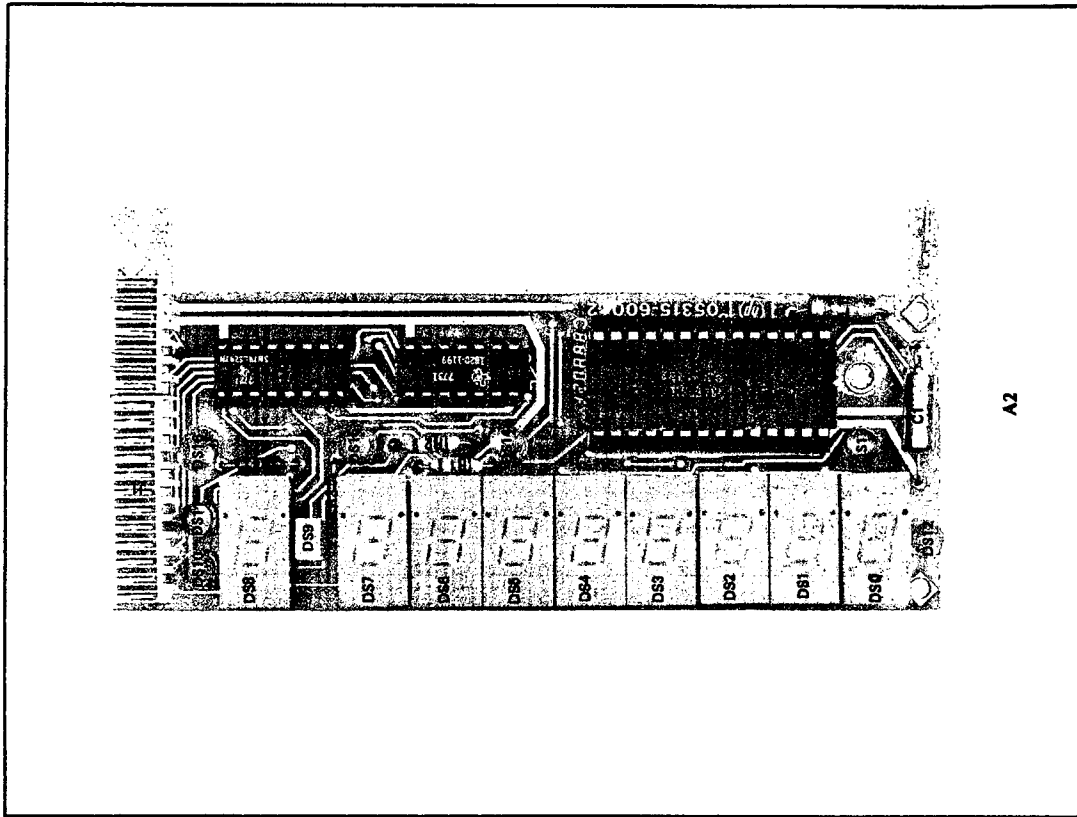

Figure 8-10. A2/A5 Display Assembly
8-53



Part of Figure 8-10. A2/A5 Display Assembly

8-149. The exponent digit is decoded by U2 and is displayed by DS8. U1 drives the annunciator LEDs for GATE, "-" (minus), HZ, and s (seconds).

8-150. A2 Display Troubleshooting

8-151. Release all of the Function Switches including the Blue Shift Key (OUT). Refer to paragraph 3-33 Display Check and verify the appropriate LEDs light as shown in Table 3-1.

The failures now can be divided into three sections:

1. Failure in the main display LEDs DS8-DS7. If all LEDs display incorrect segments, then suspect U3 Display Driver. If only one LED is incorrect, swap the suspected display with one of the good displays.
2. Failure in the exponent LED. The exponent LED should display the same number as the main display LED's DS8-DS7 during the display check. If the display is blank, suspect U2. If one segment fails to light but it appears as though the correct number as being displayed, then swap the LED with another that is known to be good. If more than one segment fails to light then suspect U2.
3. Failure in the Hertz, Seconds, Minus, or Gate LED's. A failure in this area is more easily determined by connecting the rear panel REF IN/OUT to the Channel A Input BNC and switching between FREQ A (to verify Hertz and Gate) and PER A (to verify Seconds). Verify the input to the appropriate inverter U1 is High and the corresponding output is Low. If these lines are not being pulled when the corresponding function is selected, then the problem may be the 300 (A1U1). Go to Preliminary Troubleshooting, paragraph 8-42.

NOTE

The Addressed & Remote LED's are from A1U10 (6801). These lines should go High when the 5316A is addressed and/or in remote.

8-152. A12 HP-IB INTERFACE ASSEMBLY

8-153. The A12 HP-IB Interface Assembly may be divided into the following sections:

1. Address switches. S1 1-7
2. Three-state bidirectional DIO line drivers. U1, U2
3. Bus management logic and drivers. U3, U4

8-154. The HP-IB Interface assembly is the hardware interface between the 68488 and the HP-IB bus. Additionally, A12 contains the HP-IB address switches and pull-up resistors. The signals on the HP-IB driver board are routed to the A1 assembly through a 28-conductor ribbon cable, which plugs into a 28-pin socket on both boards. The +5V and ground are also supplied through this cable.

8-155. The 7PST switch (mounted in J3), sets the HP-IB address for the instrument. The five-rightmost switches set this address, while the leftmost switch sets Addressable or Talk only. Resistor network R1 and the ground side of the switches define the TTL logic levels fed to the 68488. The switches are read during the power-up sequence, and at regular intervals during the program, whenever the 68488 (under 6801 control) sends \overline{ASE} (Address Switch Enable) to a Low state (active Low). This puts the contents of the switches onto the 8-bit data bus shared by the 68488 and the 6801.

8-156. IC U2 is an octal transceiver. Pins 1 through 8 connect to the data lines of the 68488 on the A1 assembly, and pins 12 through 19 go to the data lines of the HP-IB. Each of the HP-IB data lines are biased by the resistor network R2. The Transmit/Receive Line, pin 11 of U2 is driven by T/R2, one of the control lines of the 68488 on A1. Pin 2 is the Enable Line (active Low), which is driven by gate U1A. This disables the data lines drivers when a system controller puts the HP-IB bus into Parallel Poll (the 5316A does not respond to a Parallel Poll). U3 and U4 are quad bus transreceivers, and U5 is a quad three-state buffer. The buffers of U5 enable data to be sent to the 68488 on A1 when enabled by the driver control lines $T/\overline{R1}$, $\overline{T}/R2$, $T/\overline{R2}$. They go into the high impedance state when the 68488 wants to send signals over DAC, DAV, and RFD, the HP-IB control lines. The SRQ line is sent active by the 5316A when the SR1 command has been programmed and the 6801 on A1 determines that service is needed (a measurement has been completed and the 5316A has data to output).

8-157. The EOI line is received by the 68488 on the A1 Motherboard assembly, but the 6801 does not respond to it; rather, external input of instructions terminates with Carriage Return/Line Feed, and this is what the 6801 looks for. Remote Enable (REN) is sent by the controller to the 5316A, as is Interface Clear (IFC). The 6801 and 68488 follow IEEE 488-1978 rules for these lines. Attention (ATN) is received by the 68488 and is used as an internal qualifier.

8-158. A12 HP-IB Interface Troubleshooting

8-159. For troubleshooting purposes, the A12 assembly may be divided into three sections, each of which may be inspected separately:

- a. The HP-IB address switches, A1-A5, and Addressable/Talk Only, may be checked by removing the 6801 (A1U10) and the 68488 (A1U12) and grounding pin 4 of the 68488 socket (\overline{ASE}). This enables A1U14, the three-state buffer that drives DB0-DB7 of the 68488. Place all of the address switches in the down position (open). Apply power to the 5316A and place a logic probe on the corresponding pins of the 68488 socket should go High (the output of A1U14 is inverted). If any of the lines fail to go High when the switch is closed, verify the input line to A1U14 is going Low. If the line is not going Low, the switch is probably bad or a trace is broken.

- NOTES:
1. REFERENCE DESIGNATIONS WITHIN THIS DRAWING ARE TO THE PARTS LIST AND SHOULD BE REFERENCED TO THE PARTS LIST FOR COMPLETE DESCRIPTION.
 2. UNLESS OTHERWISE INDICATED, CAPACITANCE IS IN FARADS.
 3. DIMENSIONS ARE IN INCHES.
 4. COLLECTED COMPONENT, AVERAGE VALUE GIVEN.

TABLE OF ACTIVE COMPONENTS	
REFERENCE DESIGNATION	DESCRIPTION
U1	74181
U2	74182
U3	74183
U4	74184
U5	74185

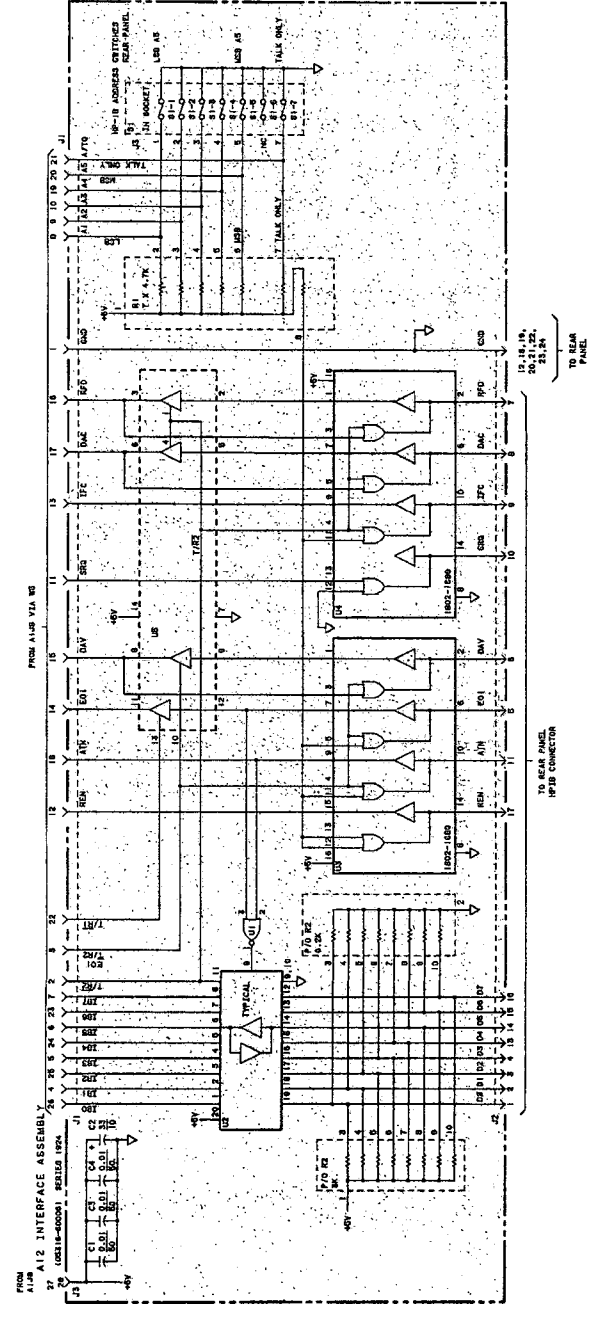
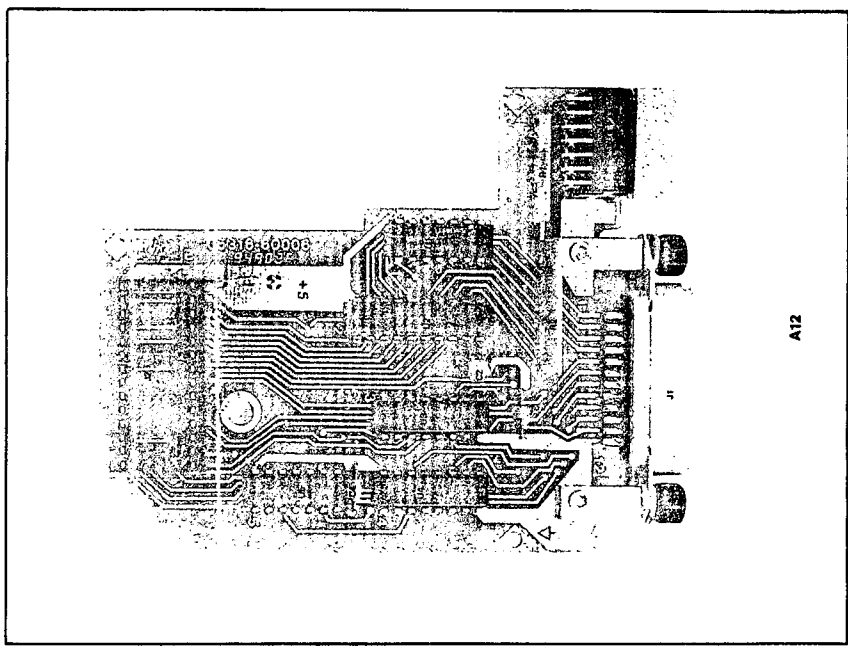

Figure 8-11. A12 HP-IB Interface Assembly
8-55



Part of Figure 8-11. A12 HP-IB Interface Assembly

The following table lists the bit, the switch number, the pin of the A12 interconnect ribbon connector, the input and output pins of the three-state buffer A1U14, and the input pins to the 68488, A1U12.

BIT	SWITCH	A1U14 IN/OUT	A1U12 PIN
A1	S1-1	6	7
A2	S1-2	2/3	6
A3	S1-3	10	9
A4	S1-4	6/7	10
A5	S1-5	19	10/9
A6	S1-6	20	12/11
A7	S1-7	21	14/13

The DIO line bidirectional transceivers may be checked by activating the T/R2 line (High for Transmit, Low for Receive) of the 68488. With the use of a logic pulser and probe the eight DIO lines can be verified. Remove the 6801 (A1U10) and 68488 (A1U12) from their sockets. Ground pin 27 of the 68488 socket (T/R2 receive mode). Using the following table, pulse each of the DIO lines at the HP-IB connector (A12J1) and verify the corresponding pins on the 68488 socket pulser.

DIO LINE	A12J1 PIN	A12J2 IN/OUT	A12J1 PIN	A1U12 PIN
0	1	18/1	26	36
1	2	18/2	27	35
2	3	17/3	25	34
3	4	16/4	5	33
4	13	15/5	24	32
5	14	14/6	6	31
6	15	13/7	23	30
7	16	12/8	7	29

Now connect pin 27 of the 68488 socket to +5 volts (transmit mode) and pulse the pin of the 68488 socket and verify the corresponding pins on the HP-IB connector (J1) pulser.

The bus management lines can be tested in the same way as the DIO lines. Follow the table below and pulse the appropriate pin HP-IB connector and verify the corresponding pin of the 68488 socket pulser. Certain lines require an enable line to be activated (i.e., EOI, DAV). The table below specifies when this must be done.

BUS LINE	HP-IB CONN	A12J1	A1U12
REN	17	12	22
ATN	11	18	26
EOI	5	14	25
DAV	6	15	16
IFC	9	13	21
DFC	8	16	18
RFD	7	16	18

BUS LINE	A1U12	A12J2	HP-IB CONN
EN0	23	11	10
DAC	17	17	8
RFD	18	16	7