

---

# Semiconductor Parameter Analyzer

---

HP-IB Command  
Reference

© Copyright Hewlett-Packard Company 1993, 1994

All Rights Reserved.

Reproduction, adaptation, or translation without prior written permission is prohibited, except as allowed under the copyright laws.

HP Part Number  
04155-90120

#### **Printing History**

First edition, February 1994  
Second edition, December 1994

Printed in Japan

MS-DOS® is U.S. registered trademark of Microsoft Corporation.

Lotus 1-2-3 is U.S. registered trademark of Lotus Development Corporation.

PageMaker is a trademark of Aldus Corporation.

#### **Product Warranty**

This Hewlett-Packard product is warranted against defects in material and workmanship for a period of one year from date of shipment. During the warranty period, Hewlett-Packard will, at its option, either repair or replace products which prove to be defective.

For warranty service or repair, this product must be returned to a service facility designated by Hewlett-Packard. Buyer shall prepay shipping charges to Hewlett-Packard and Hewlett-Packard shall pay shipping charges to return the product to Buyer. However, Buyer shall pay all shipping charges, duties, and taxes for products returned to Hewlett-Packard from another country.

Hewlett-Packard warrants that its software and firmware designated by Hewlett-Packard for use with an instrument will execute its programming instructions when properly installed on that instrument. Hewlett-Packard does not warrant that the operation of the instrument, or software, or firmware will be uninterrupted or error free.

#### **Limitation of Warranty**

The foregoing warranty shall not apply to defects resulting from improper or inadequate maintenance by Buyer, Buyer-supplied software or interfacing, unauthorized modifications or misuse, operation outside of the environment specifications for the products, or improper site preparation or maintenance.

No other warranty is expressed or implied. Hewlett-Packard specifically disclaims the implied warranties of merchantability and fitness for a particular purpose.

#### **Exclusive Remedies**

The remedies provided herein are the Buyer's sole and exclusive remedies. Hewlett-Packard shall not be liable for any direct, indirect, special, incidental, or consequential damages, whether based on contract, tort, or any other legal theory.

#### **Assistance**

Product maintenance agreements and other customer assistance agreements are available for Hewlett-Packard products.

For any assistance, contact your nearest Hewlett-Packard Sales Office.

#### **Certification**

Hewlett-Packard Company certifies that this product met its published specifications at the time of shipment [from the factory]. Hewlett-Packard further certifies that its calibration measurements are traceable to the **National Institute of Standards and Technology** [NIST], to the extent allowed by the Institute's calibration facility, and to the calibration facilities of other International Standards Organization members.

— |

| —

— |

| —

---

## In This Manual

This manual provides information about remote control commands to operate the HP 4155A/4156A via HP-IB interface.

This manual consists of the following chapters based on command types:

- SCPI Commands
- HP 4145B Syntax Commands
- Manual Changes Depending on ROM Version

Refer to the HP 4155A/4156A *Programmer's Guide* to make a program and use built-in HP Instrument BASIC.

See the HP 4155A/4156A *User's Task Guide* and *User's Dictionary Reference* for information about HP 4155A/4156A itself.

### **Text Conventions.**

The following text conventions are used in this manual:

<b>Front-panel key</b>	Represents a key physically located on HP 4155A/4156A.
<b>Softkey</b>	Represents a softkey that appears on screen of HP 4155A/4156A.
<b>Screen Text</b>	Represents text displayed on HP 4155A/4156A.
<i>Italic</i>	Refers to a related document, or is used for emphasis.

---

# Contents

## 1. SCPI Commands

CALibration Subsystem . . . . .	1-4
:CALibration[:ALL]? . . . . .	1-5
:CALibration:AUTO . . . . .	1-6
:CALibration:ERRor? . . . . .	1-6
:CALibration:SElected? . . . . .	1-8
DATA   TRACe Subsystem . . . . .	1-10
:DATA TRACe:CATalog? . . . . .	1-11
:DATA TRACe[:DATA] . . . . .	1-11
:DATA TRACe:DEFine . . . . .	1-13
:DATA TRACe:DElete:ALL . . . . .	1-14
:DATA TRACe:DElete[:NAME] . . . . .	1-15
:DATA TRACe:FREE? . . . . .	1-15
:DATA TRACe:POINts . . . . .	1-16
:DATA TRACe:STATus? . . . . .	1-17
:DATA TRACe:UNIT . . . . .	1-19
DIAGnostic Subsystem . . . . .	1-20
:DIAGnostic:TEST:ABORt . . . . .	1-21
:DIAGnostic:TEST:CONTinue . . . . .	1-21
:DIAGnostic:TEST:ERRor? . . . . .	1-22
:DIAGnostic:TEST[:EXECute] . . . . .	1-23
:DIAG:TEST:RESult? . . . . .	1-25
DISPlay Subsystem . . . . .	1-27
:DISPlay:BRIGHtness . . . . .	1-28
:DISPlay:CMAP:COLor<n>:HSL . . . . .	1-28
:DISPlay:CMAP:DEFault . . . . .	1-30
:DISPlay:CONTrast . . . . .	1-30
:DISPlay[:WINDow]:ALLocation . . . . .	1-31
:DISPlay[:WINDow][:STATe] . . . . .	1-32
FORMat Subsystem . . . . .	1-33
:FORMat:BORDer . . . . .	1-34
:FORMat[:DATA] . . . . .	1-35
HCOPY Subsystem . . . . .	1-36
:HCOPY:ABORt . . . . .	1-39
:HCOPY:DATA? . . . . .	1-39
:HCOPY:DESTination . . . . .	1-40

## Change 1

:HCOPY:DEVICE:CMOD . . . . .	1-40
:HCOPY:DEVICE:COLOR . . . . .	1-42
:HCOPY:DEVICE:LANGUAGE . . . . .	1-43
:HCOPY:DEVICE:RESOLUTION . . . . .	1-43
:HCOPY[:IMMEDIATE] . . . . .	1-44
HCOPY:INIT . . . . .	1-45
:HCOPY:ITEM:ALL:DATA? . . . . .	1-45
:HCOPY:ITEM:ALL[:IMMEDIATE] . . . . .	1-46
:HCOPY:ITEM:ANNOTATION:STATE . . . . .	1-46
:HCOPY:ITEM:ANNOTATION2:STATE . . . . .	1-47
:HCOPY:ITEM:FFEED:STATE . . . . .	1-48
:HCOPY:ITEM:LABEL:STATE . . . . .	1-49
:HCOPY:ITEM:LABEL:TEXT . . . . .	1-49
:HCOPY:ITEM:TDESTAMP:STATE . . . . .	1-50
:HCOPY:ITEM:PNUMBER:STATE . . . . .	1-51
:HCOPY:ITEM[:WINDOW]:TEXT:STATE . . . . .	1-52
:HCOPY:ITEM[:WINDOW]:TEXT2:STATE . . . . .	1-52
:HCOPY:ITEM[:WINDOW]:TEXT3:STATE . . . . .	1-53
:HCOPY:ITEM[:WINDOW]:TRACE:DATA? . . . . .	1-54
:HCOPY:ITEM[:WINDOW]:TRACE:GRATICULE:STATE . . . . .	1-55
:HCOPY:ITEM[:WINDOW]:TRACE[:IMMEDIATE] . . . . .	1-55
:HCOPY:ITEM[:WINDOW]:TRACE:STATE . . . . .	1-56
:HCOPY:LINDEX . . . . .	1-57
:HCOPY:OPAGE . . . . .	1-57
:HCOPY:PAGE:COLUMN . . . . .	1-58
:HCOPY:PAGE:DIMENSIONS:LLEFT . . . . .	1-59
:HCOPY:PAGE:DIMENSIONS:QUADRANT<n> . . . . .	1-60
:HCOPY:PAGE:DIMENSIONS:URIGHT . . . . .	1-60
:HCOPY:PAGE:FDIRECTION . . . . .	1-61
:HCOPY:PAGE:LENGTH . . . . .	1-62
:HCOPY:PAGE:LINE . . . . .	1-63
:HCOPY:PAGE:SIZE . . . . .	1-63
:HCOPY:PAGE:UNIT . . . . .	1-64
:HCOPY:PAGE:WIDTH . . . . .	1-66
:HCOPY:SDUMP:DATA? . . . . .	1-66
:HCOPY:SDUMP[:IMMEDIATE] . . . . .	1-67
:HCOPY:TRAILER . . . . .	1-68
MMEMORY Subsystem . . . . .	1-69
:MMEMORY:CATALOG? . . . . .	1-70
:MMEMORY:COPY . . . . .	1-71
:MMEMORY:DELETE . . . . .	1-72

:MMEMory:INITialize . . . . .	1-72
:MMEMory:LOAD:STATe . . . . .	1-73
:MMEMory:LOAD:TRACe . . . . .	1-74
:MMEMory:MOVE . . . . .	1-75
:MMEMory:NAME . . . . .	1-75
:MMEMory:STORe:SSHeet . . . . .	1-76
:MMEMory:STORe:SSHeet:DELimiter . . . . .	1-77
:MMEMory:STORe:SSHeet:LINDex . . . . .	1-77
:MMEMory:STORe:SSHeet:SMARK . . . . .	1-78
:MMEMory:STORe:SSHeet:UNIT . . . . .	1-79
:MMEMory:STORe:STATe . . . . .	1-80
:MMEMory:STORe:TRACe . . . . .	1-81
PAGE Subsystem . . . . .	1-82
:PAGE:CHANnels[:CDEFinition]:ALL:DISable . . . . .	1-105
:PAGE:CHANnels[:CDEFinition]:COMMeNt . . . . .	1-105
:PAGE:CHANnels[:CDEFinition]:DEFault . . . . .	1-106
:PAGE:CHANnels[:CDEFinition]:GNDU:DISable . . . . .	1-106
:PAGE:CHANnels[:CDEFinition]:GNDU:MODE? . . . . .	1-107
:PAGE:CHANnels[:CDEFinition]:GNDU:VNAME . . . . .	1-107
:PAGE:CHANnels[:CDEFinition][:MENU] . . . . .	1-108
:PAGE:CHANnels[:CDEFinition]:MODE . . . . .	1-108
:PAGE:CHANnels[:CDEFinition]:SMU<n>:DISable . . . . .	1-109
:PAGE:CHANnels[:CDEFinition]:SMU<n>:FUNCTion . . . . .	1-109
:PAGE:CHANnels[:CDEFinition]:SMU<n>:INAME . . . . .	1-111
:PAGE:CHANnels[:CDEFinition]:SMU<n>:MODE . . . . .	1-112
:PAGE:CHANnels[:CDEFinition]:SMU<n> :SRESistance . . . . .	1-113
:PAGE:CHANnels[:CDEFinition]:SMU<n>:STANdby . . . . .	1-114
:PAGE:CHANnels[:CDEFinition]:SMU<n>:VNAME . . . . .	1-115
:PAGE:CHANnels[:CDEFinition]:VMU<n>:DISable . . . . .	1-116
:PAGE:CHANnels[:CDEFinition]:VMU<n>:MODE . . . . .	1-116
:PAGE:CHANnels[:CDEFinition]:VMU<n>:VNAME . . . . .	1-117
:PAGE:CHANnels[:CDEFinition]:VSU<n>:DISable . . . . .	1-118
:PAGE:CHANnels[:CDEFinition]:VSU<n>:FUNCTion . . . . .	1-119
:PAGE:CHANnels[:CDEFinition]:VSU<n>:MODE? . . . . .	1-120
:PAGE:CHANnels[:CDEFinition]:VSU<n>:STANdby . . . . .	1-121
:PAGE:CHANnels[:CDEFinition]:VSU<n>:VNAME . . . . .	1-122
:PAGE:CHANnels[:CDEFinition]:PGU<n>:DISable . . . . .	1-122
:PAGE:CHANnels[:CDEFinition]:PGU<n>:MODE . . . . .	1-123
:PAGE:CHANnels[:CDEFinition]:PGU<n>:STANdby . . . . .	1-124
:PAGE:CHANnels[:CDEFinition]:PGU<n>:VNAME . . . . .	1-124
:PAGE:CHANnels:UFUNCTion:CATalog? . . . . .	1-125

Change 1

:PAGE:CHANnels:UFUNction:DEFine . . . . .	1-126
:PAGE:CHANnels:UFUNction:DELeTe:ALL . . . . .	1-127
:PAGE:CHANnels:UFUNction:DELeTe[:NAME] . . . . .	1-127
:PAGE:CHANnels:UFUNction[:MENU] . . . . .	1-128
:PAGE:CHANnels:UVAriable:CATalog? . . . . .	1-128
:PAGE:CHANnels:UVAriable:DEFine . . . . .	1-129
:PAGE:CHANnels:UVAriable:DELeTe:ALL . . . . .	1-130
:PAGE:CHANnels:UVAriable:DELeTe[:NAME] . . . . .	1-130
:PAGE:CHANnels:UVAriable[:MENU] . . . . .	1-131
:PAGE:DISPlay:ANALySis:INTerpolate . . . . .	1-131
:PAGE:DISPlay:ANALySis:LINE(1 2):ASElect . . . . .	1-132
:PAGE:DISPlay:ANALySis:LINE(1 2):GRADient . . . . .	1-132
:PAGE:DISPlay:ANALySis:LINE(1 2):MODE . . . . .	1-133
:PAGE:DISPlay:ANALySis:LINE(1 2):POINt(1 2) :AFter	1-134
:PAGE:DISPlay:ANALySis:LINE(1 2):POINt(1 2) :AFter:STATe . . . . .	1-135
:PAGE:DISPlay:ANALySis:LINE(1 2):POINt(1 2):MODE	1-136
:PAGE:DISPlay:ANALySis:LINE(1 2):POINt(1 2) :POSiTion . . . . .	1-137
:PAGE:DISPlay:ANALySis:LINE(1 2):POINt(1 2):X . . . . .	1-137
:PAGE:DISPlay:ANALySis:LINE(1 2):POINt(1 2):Y . . . . .	1-138
:PAGE:DISPlay:ANALySis:LINE(1 2):TANGent:AFter . . . . .	1-139
:PAGE:DISPlay:ANALySis:LINE(1 2):TANGent:AFter :STATe . . . . .	1-140
:PAGE:DISPlay:ANALySis:LINE(1 2):TANGent :POSiTion . . . . .	1-141
:PAGE:DISPlay:ANALySis:MARKer:AFter . . . . .	1-141
:PAGE:DISPlay:ANALySis:MARKer:AFter:STATe . . . . .	1-142
:PAGE:DISPlay:ANALySis:MARKer:DISable . . . . .	1-143
:PAGE:DISPlay:ANALySis:MARKer:POSiTion . . . . .	1-143
:PAGE:DISPlay:ANALySis[:MENU] . . . . .	1-144
:PAGE:DISPlay[:SETup]:DVAriables:DELeTe:ALL . . . . .	1-145
:PAGE:DISPlay[:SETup]:DVAriables:DELeTe[:NAME] . . . . .	1-145
:PAGE:DISPlay[:SETup]:DVAriables[:SElect] . . . . .	1-146
:PAGE:DISPlay[:SETup]:GRAPhics:GRID . . . . .	1-147
:PAGE:DISPlay[:SETup]:GRAPhics:LPAram . . . . .	1-147
:PAGE:DISPlay[:SETup]:GRAPhics:X Y1 Y2:DELeTe . . . . .	1-148
:PAGE:DISPlay[:SETup]:GRAPhics:X Y1 Y2:MAX . . . . .	1-148
:PAGE:DISPlay[:SETup]:GRAPhics:X Y1 Y2:MIN . . . . .	1-149
:PAGE:DISPlay[:SETup]:GRAPhics:X Y1 Y2:NAME . . . . .	1-150
:PAGE:DISPlay[:SETup]:GRAPhics:X Y1 Y2:SCALe . . . . .	1-151



:PAGE:DISPlay[:SETup]:LIST:DELeTe:ALL . . . . .	1-152
:PAGE:DISPlay[:SETup]:LIST:DELeTe[:NAME] . . . . .	1-152
:PAGE:DISPlay[:SETup]:LIST[:SELeCt] . . . . .	1-153
:PAGE:DISPlay[:SETup][:MENU] . . . . .	1-153
:PAGE:DISPlay[:SETup]:MODE . . . . .	1-154
:PAGE:GLISt[:GRAPhics]:AANalysis . . . . .	1-155
:PAGE:GLISt[:GRAPhics]:ASELeCt . . . . .	1-155
:PAGE:GLISt[:GRAPhics]:CURSor:DIRect:X :Y1 :Y2 . . . . .	1-156
:PAGE:GLISt[:GRAPhics]:CURSor[:STATe] . . . . .	1-157
:PAGE:GLISt[:GRAPhics]:DISPlay:DVARiAbles . . . . .	1-157
:PAGE:GLISt[:GRAPhics]:DISPlay:OVERlay:STOVERlay . . . . .	1-158
:PAGE:GLISt[:GRAPhics]:DISPlay:OVERlay[:PLANE] . . . . .	1-158
:PAGE:GLISt[:GRAPhics]:DISPlay:OVERlay:SIInfo . . . . .	1-159
:PAGE:GLISt[:GRAPhics]:DISPlay:GRID . . . . .	1-160
:PAGE:GLISt[:GRAPhics]:DISPlay:LPARAm . . . . .	1-160
:PAGE:GLISt[:GRAPhics]:INTerpolate . . . . .	1-161
:PAGE:GLISt[:GRAPhics]:LINE:CTMarker . . . . .	1-162
:PAGE:GLISt[:GRAPhics]:LINE:GRADient . . . . .	1-162
:PAGE:GLISt[:GRAPhics]:LINE:LSELeCt . . . . .	1-163
:PAGE:GLISt[:GRAPhics]:LINE:MODE . . . . .	1-164
:PAGE:GLISt[:GRAPhics]:LINE:SCURSor . . . . .	1-164
:PAGE:GLISt[:GRAPhics]:LINE[:STATe] . . . . .	1-165
:PAGE:GLISt[:GRAPhics]:MARKer:DIRect:X :Y1 :Y2 . . . . .	1-165
:PAGE:GLISt[:GRAPhics]:MARKer:LIMit . . . . .	1-166
:PAGE:GLISt[:GRAPhics]:MARKer:SKIP . . . . .	1-167
:PAGE:GLISt[:GRAPhics]:MARKer[:STATe] . . . . .	1-167
:PAGE:GLISt[:GRAPhics][:MENU] . . . . .	1-168
:PAGE:GLISt[:GRAPhics]:SCALing:AUTO . . . . .	1-168
:PAGE:GLISt[:GRAPhics]:SCALing:CANCel . . . . .	1-169
:PAGE:GLISt[:GRAPhics]:SCALing:CENTer . . . . .	1-169
:PAGE:GLISt[:GRAPhics]:SCALing:CTMarker . . . . .	1-170
:PAGE:GLISt[:GRAPhics]:SCALing:ZOOM . . . . .	1-170
:PAGE:GLISt:LIST:ASELeCt . . . . .	1-171
:PAGE:GLISt:LIST:MARKer:DIRect . . . . .	1-171
:PAGE:GLISt:LIST:MARKer:SKIP . . . . .	1-173
:PAGE:GLISt:LIST:MARKer[:STATe] . . . . .	1-173
:PAGE:GLISt:LIST[:MENU] . . . . .	1-174
:PAGE:KSWeep:CURSor:X . . . . .	1-174
:PAGE:KSWeep:CURSor:Y . . . . .	1-175
:PAGE:KSWeep:DISPlay:DIRectiOn:X . . . . .	1-176
:PAGE:KSWeep:DISPlay:DIRectiOn:Y . . . . .	1-176

Change 1

:PAGE:KSWeep:DISPlay:GRID . . . . .	1-177
:PAGE:KSWeep:DISPlay:REGion:X . . . . .	1-178
:PAGE:KSWeep:DISPlay:REGion:Y . . . . .	1-178
:PAGE:KSWeep[:MENU] . . . . .	1-179
:PAGE:KSWeep:SCOpY . . . . .	1-179
:PAGE:KSWeep:VAR1:EXTEnt . . . . .	1-180
:PAGE:KSWeep:VAR1:MODE . . . . .	1-181
:PAGE:KSWeep:VAR1:POINts . . . . .	1-181
:PAGE:KSWeep:VAR1:POLarity . . . . .	1-182
:PAGE:KSWeep:VAR1:RANGe . . . . .	1-183
:PAGE:KSWeep:VAR1:STIME . . . . .	1-184
:PAGE:KSWeep:Y . . . . .	1-184
:PAGE:MEASure:MSETup:ITIME:LONG:APERture? . . . . .	1-185
:PAGE:MEASure:MSETup:ITIME:LONG[:NPLCycle] . . . . .	1-186
:PAGE:MEASure:MSETup:ITIME:MEDIum:APERture? . . . . .	1-187
:PAGE:MEASure:MSETup:ITIME:MEDIum:NPLCycles? . . . . .	1-187
:PAGE:MEASure:MSETup:ITIME[:MODE] . . . . .	1-188
:PAGE:MEASure:MSETup:ITIME:SHORt[:APERture] . . . . .	1-188
:PAGE:MEASure:MSETup:ITIME:SHORt:NPLCycles? . . . . .	1-189
:PAGE:MEASure:MSETup[:MENU] . . . . .	1-190
:PAGE:MEASure:MSETup:SMU <n>[:VMU <n> :RANGe	1-190
:PAGE:MEASure:MSETup:SMU <n>[:VMU <n>	
:RANGe:MODE . . . . .	1-191
:PAGE:MEASure:MSETup:WTIME . . . . .	1-192
:PAGE:MEASure:MSETup:ZCANcel	
:SMU <n>[:VMU <n>? . . . . .	1-193
:PAGE:MEASure:MSETup:ZCANcel[:STATE] . . . . .	1-194
:PAGE:MEASure:OSEquence[:MENU] . . . . .	1-195
:PAGE:MEASure:OSEquence:MODE . . . . .	1-195
:PAGE:MEASure:OSEquence:OSEquence . . . . .	1-196
:PAGE:MEASure:OSEquence:TRIGger:FUNCTion . . . . .	1-197
:PAGE:MEASure:OSEquence:TRIGger:POLarity . . . . .	1-197
:PAGE:MEASure:OSEquence:TRIGger[:STATE] . . . . .	1-198
:PAGE:MEASure:OSEquence:TRIGger:TIME . . . . .	1-199
:PAGE:MEASure:PGUSetup:CONStant:PGU <n>	
[:SOURce] . . . . .	1-200
:PAGE:MEASure:PGUSetup[:MENU] . . . . .	1-201
:PAGE:MEASure:PGUSetup:PULSe:PGU <n>:BASE . . . . .	1-201
:PAGE:MEASure:PGUSetup:PULSe:PGU <n>:COUNT . . . . .	1-202
:PAGE:MEASure:PGUSetup:PULSe:PGU <n>:DELay . . . . .	1-203

:PAGE:MEASure:PGUSetup:PULSe:PGU<n> :IMPedance . . . . .	1-204
:PAGE:MEASure:PGUSetup:PULSe:PGU<n> :LEADing . . . . .	1-205
:PAGE:MEASure:PGUSetup:PULSe:PGU<n>:PEAK . . . . .	1-206
:PAGE:MEASure:PGUSetup:PULSe:PGU<n>:PERiod . . . . .	1-207
:PAGE:MEASure:PGUSetup:PULSe:PGU<n>:TRAILing . . . . .	1-208
:PAGE:MEASure:PGUSetup:PULSe:PGU<n>:WIDTh . . . . .	1-209
:PAGE:MEASure:SAMPLing:CONStant:SMU<n> :COMpliance . . . . .	1-210
:PAGE:MEASure:SAMPLing:CONStant:SMU<n> [:SOURce] . . . . .	1-211
:PAGE:MEASure:SAMPLing:CONStant:VSU<n> [:SOURce] . . . . .	1-212
:PAGE:MEASure:SAMPLing:FILTer . . . . .	1-213
:PAGE:MEASure:SAMPLing:HTIME . . . . .	1-213
:PAGE:MEASure:SAMPLing:IINterval . . . . .	1-214
:PAGE:MEASure:SAMPLing[:MENU] . . . . .	1-215
:PAGE:MEASure:SAMPLing:MODE . . . . .	1-215
:PAGE:MEASure:SAMPLing:PERiod . . . . .	1-216
:PAGE:MEASure:SAMPLing:PERiod:AUTO . . . . .	1-217
:PAGE:MEASure:SAMPLing:POINts . . . . .	1-217
:PAGE:MEASure:SAMPLing:SCONdition:ECOUNT . . . . .	1-218
:PAGE:MEASure:SAMPLing:SCONdition:EDELay . . . . .	1-219
:PAGE:MEASure:SAMPLing:SCONdition:EVENT . . . . .	1-220
:PAGE:MEASure:SAMPLing:SCONdition:NAME . . . . .	1-220
:PAGE:MEASure:SAMPLing:SCONdition[:STATE] . . . . .	1-221
:PAGE:MEASure:SAMPLing:SCONdition:THREShold . . . . .	1-222
:PAGE:MEASure[:SWEep]:CONStant:SMU<n> :COMpliance . . . . .	1-223
:PAGE:MEASure[:SWEep]:CONStant:SMU<n> [:SOURce] . . . . .	1-224
:PAGE:MEASure[:SWEep]:CONStant:VSU<n> [:SOURce] . . . . .	1-225
:PAGE:MEASure[:SWEep]:DELay . . . . .	1-226
:PAGE:MEASure[:SWEep]:HTIME . . . . .	1-227
:PAGE:MEASure[:SWEep][:MENU] . . . . .	1-227
:PAGE:MEASure[:SWEep]:PULSe:BASE . . . . .	1-228
:PAGE:MEASure[:SWEep]:PULSe:PERiod . . . . .	1-229
:PAGE:MEASure[:SWEep]:PULSe:WIDTh . . . . .	1-229
:PAGE:MEASure[:SWEep]:SSTop . . . . .	1-230
:PAGE:MEASure[:SWEep]:VAR1:COMpliance . . . . .	1-231

Change 1

:PAGE:MEASure[:SWEep]:VAR1:MODE . . . . .	1-232
:PAGE:MEASure[:SWEep]:VAR1:PCOMpliance . . . . .	1-233
:PAGE:MEASure[:SWEep]:VAR1:PCOMpliance:STATe	1-234
:PAGE:MEASure[:SWEep]:VAR1:SPACing . . . . .	1-235
:PAGE:MEASure[:SWEep]:VAR1:STARt . . . . .	1-235
:PAGE:MEASure[:SWEep]:VAR1:STEP . . . . .	1-236
:PAGE:MEASure[:SWEep]:VAR1:STOP . . . . .	1-237
:PAGE:MEASure[:SWEep]:VAR2:COMPLiance . . . . .	1-238
:PAGE:MEASure[:SWEep]:VAR2:PCOMpliance . . . . .	1-239
:PAGE:MEASure[:SWEep]:VAR2:PCOMpliance:STATe	1-240
:PAGE:MEASure[:SWEep]:VAR2:POINts . . . . .	1-241
:PAGE:MEASure[:SWEep]:VAR2:STARt . . . . .	1-242
:PAGE:MEASure[:SWEep]:VAR2:STEP . . . . .	1-243
:PAGE:MEASure[:SWEep]:VARD:COMPLiance . . . . .	1-243
:PAGE:MEASure[:SWEep]:VARD:OFFSet . . . . .	1-244
:PAGE:MEASure[:SWEep]:VARD:PCOMpliance . . . . .	1-245
:PAGE:MEASure[:SWEep]:VARD:PCOMpliance:STATe	1-246
:PAGE:MEASure[:SWEep]:VARD:RATio . . . . .	1-247
:PAGE:SCONTrol:KSWEep[:STARt] . . . . .	1-248
:PAGE:SCONTrol[:MEASurement]:APPend . . . . .	1-249
:PAGE:SCONTrol[:MEASurement]:REPeat . . . . .	1-249
:PAGE:SCONTrol[:MEASurement]:SINGle . . . . .	1-250
:PAGE:SCONTrol:STANdby . . . . .	1-251
:PAGE:SCONTrol:STATe? . . . . .	1-251
:PAGE:SCONTrol:STOP . . . . .	1-252
:PAGE:SCONTrol:STRess[:STARt] . . . . .	1-253
:PAGE:SCONTrol:TRIGger:INPut? . . . . .	1-253
:PAGE:SCONTrol:TRIGger:OUTPut:LEVel . . . . .	1-254
:PAGE:SCONTrol:TRIGger:OUTPut[:PULSe] . . . . .	1-254
:PAGE:SCONTrol:ZERO . . . . .	1-255
:PAGE:STRess[:CDEFinition]:ALL:DISable . . . . .	1-255
:PAGE:STRess[:CDEFinition]:COMMeNt . . . . .	1-256
:PAGE:STRess[:CDEFinition]:GNdU:DISable . . . . .	1-256
:PAGE:STRess[:CDEFinition]:GNdU:FUNcTion? . . . . .	1-257
:PAGE:STRess[:CDEFinition]:GNdU:MODE? . . . . .	1-257
:PAGE:STRess[:CDEFinition]:GNdU:NAME . . . . .	1-258
:PAGE:STRess[:CDEFinition][:MENU] . . . . .	1-259
:PAGE:STRess[:CDEFinition]:PGU<n>:DISable . . . . .	1-259
:PAGE:STRess[:CDEFinition]:PGU<n>:FUNcTion . . . . .	1-259
:PAGE:STRess[:CDEFinition]:PGU<n>:MODE . . . . .	1-260
:PAGE:STRess[:CDEFinition]:PGU<n>:NAME . . . . .	1-261

:PAGE:STress[:CDEFinition]:SElector<n>:MEASure . . . . .	1-262
:PAGE:STress[:CDEFinition]:SElector<n>:STress . . . . .	1-262
:PAGE:STress[:CDEFinition]:SMU <n>:DISable . . . . .	1-263
:PAGE:STress[:CDEFinition]:SMU <n>:FUNction . . . . .	1-264
:PAGE:STress[:CDEFinition]:SMU <n>:MODE . . . . .	1-265
:PAGE:STress[:CDEFinition]:SMU <n>:NAME . . . . .	1-266
:PAGE:STress[:CDEFinition]:TRIGger:POLarity . . . . .	1-267
:PAGE:STress[:CDEFinition]:TRIGger[:STATe] . . . . .	1-267
:PAGE:STress[:CDEFinition]:VSU <n>:DISable . . . . .	1-268
:PAGE:STress[:CDEFinition]:VSU <n>:FUNction . . . . .	1-268
:PAGE:STress[:CDEFinition]:VSU <n>:MODE? . . . . .	1-269
:PAGE:STress[:CDEFinition]:VSU <n>:NAME . . . . .	1-270
:PAGE:STress:FORCe:ACCumulate . . . . .	1-271
:PAGE:STress:FORCe[:MENU] . . . . .	1-271
:PAGE:STress:FORCe:STATus . . . . .	1-272
:PAGE:STress:SETup:ACCumulate . . . . .	1-272
:PAGE:STress:SETup:CONStant:PGU <n>[:SOURce] . . . . .	1-273
:PAGE:STress:SETup:CONStant:SMU <n>:COMPLiance . . . . .	1-274
:PAGE:STress:SETup:CONStant:SMU <n>[:SOURce] . . . . .	1-275
:PAGE:STress:SETup:CONStant:VSU <n>[:SOURce] . . . . .	1-276
:PAGE:STress:SETup:DURation . . . . .	1-277
:PAGE:STress:SETup:FILTer . . . . .	1-278
:PAGE:STress:SETup:HTIME . . . . .	1-279
:PAGE:STress:SETup[:MENU] . . . . .	1-280
:PAGE:STress:SETup:MODE . . . . .	1-280
:PAGE:STress:SETup:PCOunt . . . . .	1-281
:PAGE:STress:SETup:PULSe:PGU <n>:BASE . . . . .	1-281
:PAGE:STress:SETup:PULSe:PGU <n>:DELay . . . . .	1-282
:PAGE:STress:SETup:PULSe:PGU <n>:IMPedance . . . . .	1-283
:PAGE:STress:SETup:PULSe:PGU <n>:LEADing . . . . .	1-284
:PAGE:STress:SETup:PULSe:PGU <n>:PEAK . . . . .	1-285
:PAGE:STress:SETup:PULSe:PGU <n>:PERiod . . . . .	1-286
:PAGE:STress:SETup:PULSe:PGU <n>:TRAILing . . . . .	1-287
:PAGE:STress:SETup:PULSe:PGU <n>:WIDTh . . . . .	1-288
:PAGE:STress:SETup:SSTop . . . . .	1-289
:PAGE:SYSTem:CDIagnostic[:MENU] . . . . .	1-290
:PAGE:SYSTem:COLor[:MENU] . . . . .	1-290
:PAGE:SYSTem:CONFig[:MENU] . . . . .	1-290
:PAGE:SYSTem:FILEr[:MENU] . . . . .	1-291
:PAGE:SYSTem:MISC[:MENU] . . . . .	1-291
:PAGE:SYSTem:PRINt[:MENU] . . . . .	1-292

## Change 1

PROGram Subsystem . . . . .	1-293
:PROGram:CATalog? . . . . .	1-295
:PROGram[:SElected]:DEFine . . . . .	1-295
:PROGram[:SElected]:DELete[:SElected] . . . . .	1-296
:PROGram[:SElected]:DELete:ALL . . . . .	1-296
:PROGram[:SElected]:EXECute . . . . .	1-297
:PROGram[:SElected]:MALLocate . . . . .	1-298
:PROGram[:SElected]:NAME . . . . .	1-298
:PROG[:SElected]:NUMBer . . . . .	1-298
:PROG[:SElected]:STATe . . . . .	1-299
:PROG[:SElected]:STRing . . . . .	1-300
:PROG[:SElected]:WAIT . . . . .	1-301
STATus Subsystem . . . . .	1-302
:STATus:EMERgency:ENABle . . . . .	1-305
:STATus:EMERgency[:EVENT]? . . . . .	1-305
:STATus:MEASurement:ENABle . . . . .	1-306
:STATus:MEASurement[:EVENT]? . . . . .	1-307
:STATus:OPERation:CONDition? . . . . .	1-307
:STATus:OPERation:ENABle . . . . .	1-308
:STATus:OPERation[:EVENT]? . . . . .	1-309
:STATus:OPERation:NTRansition . . . . .	1-309
:STATus:OPERation:PTRansition . . . . .	1-310
:STATus:PRESet . . . . .	1-311
:STATus:QUEStionable:CONDition? . . . . .	1-312
:STATus:QUEStionable:ENABle . . . . .	1-313
:STATus:QUEStionable[:EVENT]? . . . . .	1-314
:STATus:QUEStionable:NTRansition . . . . .	1-314
:STATus:QUEStionable:PTRansition . . . . .	1-315
SYSTem Subsystem . . . . .	1-317
:SYSTem:BEEPer:STATe . . . . .	1-319
:SYSTem:COMMunicate:GPIB:RDEvice:ADDRes . . . . .	1-319
:SYSTem:COMMunicate:GPIB[:SELF]:ADDRes . . . . .	1-320
:SYSTem:COMMunicate:SERial[:RECeive]:BAUD . . . . .	1-321
:SYSTem:COMMunicate:SERial[:RECeive]:PACE . . . . .	1-322
:SYSTem:COMMunicate:SERial[:RECeive]:PARity [:TYPE] . . . . .	1-322
:SYSTem:COMMunicate:SERial[:RECeive]:SBITs . . . . .	1-323
:SYSTem:COMMunicate:SERial:TRANsmit:BAUD . . . . .	1-324
:SYSTem:COMMunicate:SERial:TRANsmit:PACE . . . . .	1-325
:SYSTem:COMMunicate:SERial:TRANsmit:PARity [:TYPE] . . . . .	1-326

:SYSTem:COMMunicate:SERial:TRANsmit:SBITs . . . . .	1-327
:SYSTem:DATE . . . . .	1-328
:SYSTem:ERRor? . . . . .	1-328
:SYSTem:LANGuage . . . . .	1-329
:SYSTem:LFRequency . . . . .	1-330
:SYSTem:TIME . . . . .	1-330
:SYSTem:VERSion? . . . . .	1-331
Common Commands . . . . .	1-333
*CAL? . . . . .	1-334
*CLS . . . . .	1-334
*ESE . . . . .	1-335
*ESR? . . . . .	1-336
*IDN? . . . . .	1-337
*OPC . . . . .	1-338
*OPT? . . . . .	1-339
*PCB . . . . .	1-339
*RST . . . . .	1-340
*SRE . . . . .	1-340
*STB? . . . . .	1-342
*TRG . . . . .	1-343
*TST? . . . . .	1-344
*WAI . . . . .	1-344
Functional Syntax Conventions . . . . .	1-345
Program Message Syntax . . . . .	1-345
Parameter Types . . . . .	1-347
Response Message Syntax . . . . .	1-354
Response Data Types . . . . .	1-355
Status Reporting Structure . . . . .	1-362
Status Byte Register . . . . .	1-364
Service Request Enable Register . . . . .	1-366
Standard Event Status Register . . . . .	1-367
Standard Event Status Enable Register . . . . .	1-368
Output Queue . . . . .	1-369
Operation Status Register . . . . .	1-370
Questionable Status Register . . . . .	1-373
Emergency Status Register . . . . .	1-375
Measurement/Stress Status Register . . . . .	1-377
Error Messages . . . . .	1-379
No Error . . . . .	1-380
Command Error . . . . .	1-380
Execution Error . . . . .	1-384

**Change 1**

Device-Specific Error . . . . .	1-387
Query Error . . . . .	1-388

**2. HP 4145B Syntax Command Set**

General Conventions . . . . .	2-3
Differences from HP 4145A/B Commands . . . . .	2-5
System Mode Commands . . . . .	2-10
DE . . . . .	2-12
CH . . . . .	2-13
VS . . . . .	2-14
VM . . . . .	2-15
SS . . . . .	2-16
VR . . . . .	2-17
IR . . . . .	2-18
VP . . . . .	2-19
IP . . . . .	2-20
VC . . . . .	2-21
IC . . . . .	2-22
SC . . . . .	2-23
HT . . . . .	2-24
DT . . . . .	2-25
RT . . . . .	2-26
FS . . . . .	2-27
SM . . . . .	2-28
WT . . . . .	2-29
IN . . . . .	2-30
NR . . . . .	2-31
DM . . . . .	2-32
XN, YA, YB . . . . .	2-33
XT . . . . .	2-34
LI . . . . .	2-35
MX . . . . .	2-36
SH . . . . .	2-37
MD . . . . .	2-37
ME . . . . .	2-38
AS . . . . .	2-39
SV . . . . .	2-40
GT . . . . .	2-41
DO . . . . .	2-42
PR . . . . .	2-44
GL . . . . .	2-44



User Mode Commands . . . . .	2-45
US . . . . .	2-46
DV . . . . .	2-47
DI . . . . .	2-48
DS . . . . .	2-49
TV . . . . .	2-50
TI . . . . .	2-52
GL . . . . .	2-54
HP-GL Commands . . . . .	2-54
Common Mode Commands . . . . .	2-56
DC . . . . .	2-57
DL . . . . .	2-58
DP . . . . .	2-59
EI . . . . .	2-60
IT . . . . .	2-61
SF . . . . .	2-62
DR . . . . .	2-63
BC . . . . .	2-64
CA . . . . .	2-65
PL . . . . .	2-66
PF . . . . .	2-67
ID . . . . .	2-68
HP 4145B Syntax Mode Status Byte . . . . .	2-69

**3. Manual Changes Depending on ROM Version**

Change 1 . . . . .	3-3
--------------------	-----

**Index**

---

## Figures

1-1. Program Message Syntax . . . . .	1-345
1-2. Subsystem Command Syntax . . . . .	1-346
1-3. Common Command Syntax . . . . .	1-346
1-4. (Decimal) Numeric Parameter . . . . .	1-347
1-5. String Parameter . . . . .	1-349
1-6. Character Parameter . . . . .	1-350
1-7. Definite Length Arbitrary Block Parameter . . . . .	1-351
1-8. Indefinite Length Arbitrary Block Parameter . . . . .	1-351
1-9. Non-decimal Numeric Parameter . . . . .	1-352
1-10. Boolean Parameter . . . . .	1-353
1-11. Response Message Syntax . . . . .	1-354
1-12. NR1 Numeric Response Data . . . . .	1-356
1-13. NR2 Numeric Response Data . . . . .	1-356
1-14. NR3 numeric response data . . . . .	1-357
1-15. Hexadecimal Numeric Response Data . . . . .	1-357
1-16. Octal Numeric Response Data . . . . .	1-358
1-17. Binary Numeric Response Data . . . . .	1-358
1-18. String Response Data . . . . .	1-359
1-19. Character Response Data . . . . .	1-360
1-20. <response mnemonic> . . . . .	1-360
1-21. Definite Length Arbitrary Block Response Data . . . . .	1-361
1-22. Indefinite Length Arbitrary Block Response Data . . . . .	1-361
1-23. Status Reporting Structure . . . . .	1-363
1-24. Status Byte Register . . . . .	1-364
1-25. Service Request Enable Register . . . . .	1-366
1-26. Standard Event Status Register . . . . .	1-367
1-27. Output Queue . . . . .	1-369
1-28. Operation Status Register . . . . .	1-371
1-29. Questionable Status Register . . . . .	1-374
1-30. Emergency Status Register . . . . .	1-375
1-31. Measurement/Stress Status Register . . . . .	1-377

---

## Tables

1-1. CALibration Subsystem . . . . .	1-4
1-2. DATA Subsystem . . . . .	1-10
1-3. CALibration Subsystem . . . . .	1-20
1-4. DISPlay Subsystem . . . . .	1-27
1-5. FORMat Subsystem . . . . .	1-33
1-6. HCOPy Subsystem (1 of 3) . . . . .	1-36
1-7. HCOPy Subsystem (2 of 3) . . . . .	1-37
1-8. HCOPy Subsystem (3 of 3) . . . . .	1-38
1-9. MMEMory Subsystem . . . . .	1-69
1-10. PAGE Subsystem Command Hierarchy and User Interface Pages . . . . .	1-83
1-11. CHANNELS: CHANNEL DEFINITION page (1 of 2) . . . . .	1-84
1-12. CHANNELS: USER FUNCTION DEFINITION page . . . . .	1-85
1-13. CHANNELS: USER VARIABLE DEFINITION page . . . . .	1-86
1-14. MEASURE: SWEEP SETUP page (1 of 2) . . . . .	1-87
1-15. MEASURE: SWEEP SETUP page (2 of 2) . . . . .	1-88
1-16. MEASURE: SAMPLING SETUP page . . . . .	1-89
1-17. MEASURE: PGU SETUP page . . . . .	1-90
1-18. MEASURE: MEASUREMENT SETUP page . . . . .	1-91
1-19. MEASURE: OUTPUT SEQUENCE page . . . . .	1-92
1-20. DISPLAY: DISPLAY SETUP page (1 of 2) . . . . .	1-93
1-21. DISPLAY: AUTO ANALYSIS SETUP page . . . . .	1-95
1-22. GRAPH/LIST: GRAPHICS page (1 of 2) . . . . .	1-96
1-23. GRAPH/LIST: GRAPHICS page (2 of 2) . . . . .	1-97
1-24. GRAPH/LIST: LIST page . . . . .	1-97
1-25. STRESS: CHANNEL DEFINITION page (1 of 2) . . . . .	1-98
1-26. STRESS: STRESS SETUP page . . . . .	1-100
1-27. STRESS: STRESS FORCE page . . . . .	1-101
1-28. KNOB SWEEP page . . . . .	1-102
1-29. SYSTEM page group . . . . .	1-103
1-30. STATE CONTROL . . . . .	1-104
1-31. PROGram Subsystem . . . . .	1-293
1-32. PROGram Subsystem . . . . .	1-294
1-33. STATus Subsystem . . . . .	1-303
1-34. SYSTem Subsystem . . . . .	1-318
1-35. Common Commands . . . . .	1-333
1-36. Status Byte Register . . . . .	1-365

## Contents

1-37. Standard Event Status Register . . . . .	1-368
1-38. Operation Status Register . . . . .	1-372
1-39. QUEStionable Status Register . . . . .	1-374
1-40. EMERgency Status Register . . . . .	1-376
1-41. Measurement/Stress Status Register . . . . .	1-378
1-42. . . . .	1-379
1-43. . . . .	1-379
2-1. System Mode Commands (1 of 2) . . . . .	2-10
2-2. System Mode Commands (2 of 2) . . . . .	2-11
2-3. User Mode Commands . . . . .	2-45

**SCPI Commands**

---

# SCPI Commands

This chapter explains the following:

- SCPI commands available to operate the HP 4155A/4156A via HP-IB interface
- Conventions
- Status Reporting Structure
- Error Messages

If you are not familiar with SCPI programming, we recommend that you first read *HP 4155A/4156A Programmer's Guide*.

- SCPI commands

SCPI is a universal programming language for electronic test and measurement instruments, and based on IEEE 488.1 and IEEE 488.2.

SCPI commands are divided into two types: subsystem commands and common commands.

- Subsystem commands

Subsystem commands are mostly measurement related and some are general purpose. Subsystem commands have a hierarchical structure distinguished by the colon used between keywords.

The following subsystems are included:

CALibration	performs system calibration.
DIAGnostic	performs system diagnostics.
DISPlay	controls display condition.
FORMat	sets a data format for transferring numeric and array information.
HCOPY	performs print/plot function.
MMEMy	provides mass storage capability.
PAGE	defines the fields on the user interface pages of HP 4155A/4156A and controls the user interface page operation.

PROGram	generates and controls the user-defined HP Instrument BASIC program resident in an instrument.
STATus	controls the status reporting structures.
SYSTem	controls other functions, which are not related to instrument performance.
TRACe DATA	provides user variable operation.

□ Common commands

Common commands are not measurement related, and are defined by IEEE 488.2. All common commands begin with an asterisk, such as \*RST.

The commands are in alphabetical order in this chapter.

<b>NOTE</b>	
Textual Notation	
CAPITAL LETTERS	Capital letters are the minimally required letters of the command or query program header. Lowercase letters are the long form (complete spelling), which you can omit if desired.
< >	Angular brackets indicate that the word or words enclosed represent something other than themselves.
[ ]	Square brackets are used to enclose optional information not required for execution of the command sequence.
	The vertical bar can be read as “or” and is used to separate alternative parameter options.
{ }	Braces (or curly brackets) are used to enclose one or more parameters that may be included zero or more times.

For syntax conventions, see “Functional Syntax Conventions”.

---

# CALibration Subsystem

The CALibration subsystem has the function of performing system calibration.

The following table is the command tree of CALibration subsystem.

**Table 1-1. CALibration Subsystem**

<b>Command</b>	<b>Parameter</b>
:CALibration	
[:ALL]?	
:AUTO	0   1   OFF   ON
:ERRor?	<test_number>
:SElected?	<test_number>



---

## :CALibration[:ALL]?

This command performs a full calibration of the instrument, then returns a <numeric\_value> that indicates the result of the calibration.

A zero is returned if calibration is completed successfully. Otherwise, one is returned.

In addition to the error reported by this query response, the HP 4155A/4156A still reports calibration errors through the normal status-reporting mechanism.

This command has query form *only*.

Syntax                   :CALibration[:ALL]?

Query response         *result* <newline><^END>

Result	Explanation
0	PASS
1	FAIL

The data type of *result* is NR1 response data.

Example                 OUTPUT @Hp4155;":CAL?"  
ENTER @Hp4155;A

---

**:CALibration:AUTO**

This command sets whether the instrument automatically performs calibration every 30 minutes.

At \*RST, this value is set to OFF.

Syntax                   :CALibration:AUTO OFF|ON|0|1

Parameter

Parameter	Type	Explanation
OFF or 0	boolean	Do not perform auto calibration
ON or 1	boolean	Perform auto calibration

Query response        0|1 <newline><^END>

Example                OUTPUT @Hp4155;":CAL:AUTO ON"

OUTPUT @Hp4155;":CAL:AUTO?"  
ENTER @Hp4155;A

---

**:CALibration:ERROR?**

This command returns a list of the calibration error numbers for the specified calibration item.

A zero is returned if no errors are detected.

If more than seven errors are detected, only the first seven errors are returned.

Syntax                   :CALibration:ERRor? *test\_number*

Parameter

Parameter	Type	Explanation
<i>test_number</i>	numeric	item number of the calibration 111 : ALL Unit 100 : VSU1,2/VMU1,2 101 : SMU1 102 : SMU2 103 : SMU3 104 : SMU4 105 : SMU5 106 : SMU6 107 : PGU1,2 108 : GNDU 109 : ADC

Query response           *error\_list* <newline><^END>

*error\_list* is a comma-separated list of error numbers.

The data type of *error\_list* is string response data, but does not contain double quote characters at the beginning and end of the string.

When no errors are detected, 0 is returned.

Example                   OUTPUT @Hp4155;":CAL:ERR? 101"  
ENTER @Hp4155;A\$

---

**:CALibration:SElected?**

This command performs the specified calibration item (*test\_number*) of the instrument, then returns a number that indicates the calibration result.

A zero is returned if calibration is completed successfully. Otherwise, a non-zero value (error number) is returned.

In addition to the error reported by this query response, the HP 4155A/4156A still reports calibration errors through the normal status-reporting mechanism.

This command has query form *only*.

Syntax

:CALibration:SElected? *test\_number*

Parameter

Parameter	Type	Explanation
<i>test_number</i>	numeric	item number of the calibration 100 : VSU1,2/VMU1,2 101 : SMU1 102 : SMU2 103 : SMU3 104 : SMU4 105 : SMU5 106 : SMU6 107 : PGU1,2 108 : GNDU 109 : ADC

Query response

*result* <newline><^END>

Result	Explanation
0	PASS
1	FAIL
2	DONE
3	NOT DONE

Example

```
OUTPUT @Hp4155;":CAL:SEL? 101"  
ENTER @Hp4155;A
```

---

## DATA | TRACe Subsystem

DATA | TRACe subsystem sets or loads user variables and reads out the values of other data variables.

The following table is the command tree of DATA subsystem.

**Table 1-2. DATA Subsystem**

Command	Parameter
:DATA   TRACe	
:CATalog?	
[:DATA]	<variable_name>,  <block> <numeric_value> {,<numeric_value>}
:DEFine	<variable_name> [,<numeric_value>]
:DELeTe	
:ALL	
[:NAME]	<variable_name>
:FREE?	
:POINts	<variable> [,<numeric_value>]
:UNIT	<variable_name> [,<unit>]
:STATus?	<variable_name>

---

## :DATA|:TRACe:CATalog?

This command returns a comma-separated list that contains the names of scientific constant, read out functions, and all data variables.

The data variables are:

- VNAMEs and INAMEs defined by :PAGE:CHANnels:CDEFinition subsystem.
- User functions defined by :PAGE:CHANnels:UFUNction subsystem.
- User variables defined by :DATA|:TRACe subsystem (this subsystem).
- PGU output data defined by :PAGE:MEASure:PGUSetup subsystem.
- Time data of sampling measurement
- Index of the measurement result data.

If no data variables are defined, a single empty string is returned.

This command has query form *only*.

Syntax                               :DATA| :TRACe:CATalog?

Query response                    *data\_variable\_list* <newline><^END>

*data\_variable\_list* is string response data type, but does not contain double quote characters at the beginning and end of the string.

Example                             OUTPUT @Hp4155;":DATA:CAT?"  
                                       ENTER @Hp4155;A\$

---

## :DATA|:TRACe[:DATA]

This command assigns the specified values to the specified *user variable*.

The user variable must first be defined by the :DATA|:TRACe:DEFine or :PAGE:CHANnels:UVARiable:DEFine command, or on the CHANNELS: USER VARIABLE DEFINITION page.

To transfer a block of data (REAL), you must set up the format by using FORMat Subsystem commands. Block transfer is fast because the block is directly loaded into the specified user variable.

To transfer ASCII data, the default is ASCII, so you do not need to set up the format unless you changed it to REAL. ASCII transfer is slower than block transfer because the data is transferred in ASCII, then converted and loaded into the specified user variable.

If the data source is a single *numeric\_value*, each element of the specified user variable is set to the *numeric\_value*.

Also, you can specify a different *numeric\_value* for each element of the user variable.

If the number of *numeric\_values* are less than the defined size of user variable, the remaining data elements are filled with last sent data.

If too many *numeric\_values* are sent, HP 4155A/4156A generates error -223 (too much data), and the extra data are ignored.

The query of this command returns the data values for the specified *data variable*, according to the format determined by commands in the FORMat subsystem. For the possible data variables that you can specify, see the previous command (:DATA:CATalog?).

Syntax

```
:DATA|:TRACe[:DATA]
  user_variable_name,(block_data|numeric_value{,numeric_value})
```

Query syntax is as follows:

```
:DATA|:TRACe[:DATA]? data_variable_name
```

Parameter

Parameter	Type	Explanation
<i>user_variable_name</i>	string or character	user variable name to fill
<i>block</i>	arbitrary block	block of data whose format is determined by the FORMat Subsystem
<i>numeric_value</i>	numeric	numeric value

When *user\_variable\_name* is sent as character parameter type, all alpha characters are treated as uppercase in HP 4155A/4156A.



Query response            *data\_variable\_data* <newline><^END>

The data format of *data\_variable\_data* is determined by the FORMat Subsystem (ASCIi or REAL).

Example                    OUTPUT @Hp4155;":TRAC REF,0.22361"  
  
                           OUTPUT @Hp4155;":TRAC 'Vdata',1,2,3,4,5"  
  
                           REDIM A(1:5)  
                           A(1)=1.1  
                           A(2)=1.2  
                           A(3)=1.3  
                           A(4)=1.4  
                           A(5)=1.5  
                           ASSIGN @Form\_off TO 717;FORMAT OFF  
                           OUTPUT @Hp4155;":FORM:DATA REAL,64"  
                           OUTPUT @Hp4155;":FORM:BORD NORM"  
                           OUTPUT @Hp4155;":TRAC IDATA,#6000040";  
                           OUTPUT @Form\_off;A(\*),END  
  
                           OUTPUT @Hp4155;":TRAC? 'Vdata'"  
                           ENTER @Hp4155;A(\*)  
  
                           OUTPUT @Hp4155;":TRAC? IDATA"  
                           ENTER @Hp4155;A(\*)

---

## :DATA|:TRACe:DEFine

This command defines (allocates and initializes) a new user variable.

The first parameter specifies the new user variable name. The second parameter specifies the size of user variable.

A new user variable is allocated with the specified number of data elements. The user variable is initialized with invalid data.

If the second parameter is omitted, the new user variable size is the number of VAR1 steps for sweep measurement, or the number of the sample points for sampling measurement mode.

This command does not have query form.

Syntax                    `:DATA|:TRACe:DEFine user_variable_name[,user_variable_size]`

Parameter

Parameter	Type	Explanation
<i>user_variable_name</i>	string or character	user variable name to define
<i>user_variable_size</i>	numeric	size of the user variable

When *user\_variable\_name* is sent as character parameter type, all alpha characters are treated as upper case in HP 4155A/4156A.

Example                    `OUTPUT @Hp4155;":TRAC:DEFine 'Vdata',1024"`

`OUTPUT @Hp4155;":TRAC:DEFine IDATA,1024"`

---

## **:DATA|:TRACe:DELeTe:ALL**

This command deletes all the user variable names on the CHANNELS: USER VARIABLE DEFINITION page.

This command does not have query form.

Syntax                    `:DATA|:TRACe:DELeTe:ALL`

Example                    OUTPUT @Hp4155;":TRAC:DEL:ALL"

## :DATA|:TRACe:DELeTe[:NAME]

This command deletes the specified user variable name on the CHANNELS: USER VARIABLE DEFINITION page.

This command does not have query form.

Syntax                    :DATA|:TRACe:DELeTe[:NAME]*user\_variable\_name*

Parameter

Parameter	Type	Explanation
<i>user_variable_name</i>	string or character	user variable name to delete

When *user\_variable\_name* is sent in character program data format, all alpha characters are treated as upper case in HP 4155A/4156A.

Example                    OUTPUT @Hp4155;":TRAC:DEL 'Vdata' "

OUTPUT @Hp4155;":TRAC:DEL IDATA"

## :DATA|:TRACe:FREE?

This command returns the amount of user memory space available for data variables.

This command has query form *only*.

Syntax `:DATA|:TRACe:FREE?`

Query response `available,used <newline><^END>`

*available* is the available data variable memory space in bytes.

*used* is the used data variable memory space in bytes.

Both are returned in NR1 response data format.

Example `OUTPUT @Hp4155;":TRAC:FREE?"`  
`ENTER @Hp4155;A,B`

## **:DATA|:TRACe:POINts**

This command resizes the number of elements in an already defined user variable.

The first parameter specifies the name of the user variable to resize.

The optional second parameter specifies the new size for the specified user variable. If this parameter is omitted, the new user variable size is the number of VAR1 steps for sweep measurement, or the number of the sampling points for sampling measurement.

Syntax `:DATA|:TRACe:POINts user_variable_name [ ,user_variable_size ]`

Parameter

Parameter	Type	Explanation
<i>user_variable_name</i>	string or character	user variable name to resize
<i>user_variable_size</i>	numeric	new size of the user variable

Query response `user_variable_size <newline><^END>`

The data type of *user\_variable\_size* is NR1 response data format.

Example                    OUTPUT @Hp4155;":TRAC:POIN 'Vdata',2048"  
                           OUTPUT @Hp4155;":TRAC:POIN IDATA,2048"  
                           OUTPUT @Hp4155;":TRAC:POIN? 'Vdata'"  
                           ENTER @Hp4155;A  
                           OUTPUT @Hp4155;":TRAC:POIN? IDATA"  
                           ENTER @Hp4155;A

---

## :DATA|:TRACe:STATus?

This command returns the status of the specified data variable.  
 This command has query form *only*.

Syntax                    :DATA|:TRACe:STATus? *data\_variable\_name*

Parameter

Parameter	Type	Explanation
<i>data_variable_name</i>	string or character	data variable name

Query response            *status* <newline><^END>

bit	binary-weight	description
0	1	Stack Register Overflow
1	2	Calculation error
2	4	Insufficient data
3	8	Not used  always 0
4	16	A/D converter overflow occurs.
5	32	SMU or VSU oscillates.
6	64	Other SMU reaches its compliance setting.
7	128	This SMU reaches its compliance setting.
8 to 15		Not used  always 0

If the ASCII transfer format was selected by the FORMat subsystem, *status* is an integer value that is the sum of the binary-weighted values for the bits in NR1 response data format.

If the REAL transfer format was selected by the FORMat subsystem, *status* is definite length block data with 16-bit integer format. The length of the returned block depends on the specified *data\_variable\_name*.

Example

```
OUTPUT @Hp4155;":TRAC:STAT? 'Vdata'"
ENTER @Hp4155;A(*)
```

```
OUTPUT @Hp4155;":TRAC:STAT? IDATA"
ENTER @Hp4155;A(*)
```

---

## :DATA|:TRACe:UNIT

This command sets the unit for data of the specified user variable.

The user variable must first be defined by the :DATA|:TRACe:DEFine or :PAGE:CHANnels:UVARiable:DEFine command, or on the CHANNELS: USER VARIABLE DEFINITION page.

Syntax                                :DATA| :TRACe:UNIT *user\_variable\_name* ,*unit*

Parameter

Parameter	Type	Explanation
<i>user_variable_name</i>	string or character	user variable name to specify unit for
<i>unit</i>	string	unit of the user variable data

Query response                        *unit* <newline><^END>

*unit* is string response data type but it does not contain double quote characters at beginning and end of string.

Example

```
OUTPUT @Hp4155;":TRAC:UNIT 'Vdata','mV'"
```

```
OUTPUT @Hp4155;":TRAC:UNIT IDATA,'mV'"
```

```
OUTPUT @Hp4155;":TRAC:UNIT? 'Vdata'"
ENTER @Hp4155;A$
```

```
OUTPUT @Hp4155;":TRAC:UNIT? IDATA"
ENTER @Hp4155;A$
```

---

## DIAGnostic Subsystem

The DIAGnostic subsystem has diagnostic functions that are used in routine maintenance and repair.

The following table is the command tree of DIAGnostic subsystem.

**Table 1-3. CALibration Subsystem**

<b>Command</b>	<b>Parameter</b>
:DIAGnostic	
:TEST	
[:EXECute]	<test_number>
:ABORt	
:CONTinue	
:ERRor?	<test_number>
:RESult?	



---

## **:DIAGnostic:TEST:ABORt**

This command forcibly terminates the diagnostics operation.

This command may set the Operation Complete flag to true since it terminates the executing diagnostics operation.

This command does not have query form.

Syntax                    **:DIAGnostic:TEST:ABORt**

Example                    **OUTPUT @Hp4155;":DIAG:TEST:ABOR"**

---

## **:DIAGnostic:TEST:CONTInue**

This command is used for interactive testing.

For interactive testing, operation pauses to wait for operation by user.

This command continues the test from pause status.

This command does not have query form.

Syntax                    **:DIAGnostic:TEST:CONTInue**

Example

```
OUTPUT @Hp4155;":DIAG:TEST:RES?"  
ENTER @Hp4155;A  
IF A = -1 THEN ! -1 means pause status (waiting to continue)  
    OUTPUT @Hp4155;":DIAG:TEST:CONT"  
END IF
```

## :DIAGnostic:TEST:ERRor?

This command returns a list of error numbers for the specified diagnostic test item.

A zero is returned if no errors are detected.

If more than seven errors are detected, only the first seven errors are returned.

This command has query form *only*.

Syntax                   :DIAGnostic:TEST:ERRor? *test\_number*

Parameter                The definitions of *test\_number* are the same as for the :DIAGnostic:TEST:EXECute command.

Query response           *error\_list* <newline><^END>

*error\_list* is a list of comma-separated error numbers.

The data type of *error\_list* is string response data but does not contain double quote at the beginning and end of the string.

Example                   OUTPUT @Hp4155;":DIAG:TEST:ERR? 101"  
                          ENTER @Hp4155;A\$

See also                 :DIAGnostic:TEST:EXECute

---

## :DIAGnostic:TEST[:EXECute]

This command performs the specified diagnostic test item (*test\_number*) of the instrument.

This command sets the Operation Complete flag to false until the diagnostics initiated by this command finishes. This affects the execution of the \*OPC, \*OPC?, and \*WAI commands.

This command does not have query form.

Syntax                               :DIAGnostic:TEST[:EXECute]*test\_number*

Parameter

Parameter	Type	Explanation
<i>test_number</i>	numeric	item number of the diagnostic test

The following *test\_number* values are available:

Unit test	Explanation
111	Test all units
100	VSU1,2/VMU1,2
101	SMU1
102	SMU2
103	SMU3
104	SMU4
105	SMU5
106	SMU6
107	PGU1,2
108	GNDU
109	ADC

SCPI Commands

**DIAGnostic Subsystem**

<b>CRT test</b>	<b>Explanation</b>
201	ALL White
202	ALL Red
203	ALL Green
204	ALL Blue
205	16 Step Gray Scale
206	3 Step Gray Scale
207	Convergence Pattern
208	Crosshatch
209	Inverted Crosshatch
210	H Pattern
211	Pixel Stretching
212	Repeating Gray Scale
213	Color Rainbow
214	Character Set
215	Bandwidth Pattern

<b>CPU test</b>	<b>Explanation</b>
311	All cpu tests
301	HOSTC DRAM
302	HOST Memories (ROM, SRAM)
303	Real Time Clock
304	HP-IB Controller
305	Serial I/F Controller
306	Host <-> SMUC I/F
307	SMUC Memories, Timer
308	Graphics Processor
309	Graphic Memories (DRAM, VRAM)
310	Sound Generator

IO & Peripheral test	Explanation
401	Serial I/F
402	Trigger Input/Output
403	Interlock & LED
404	Flexible Disk Controller
405	Flexible Disk Read/Write
406	Post regulator 12V/65V
407	Front Key Circuit
408	Front Key Entry
409	Front Key LED
410	External Key Controller
411	External Key Entry
412	SMU/PGU Selector Control
413	R-box Control

Example                    `OUTPUT @Hp4155;":DIAG:TEST 101"`

---

## **:DIAG:TEST:RESult?**

This query command returns the result of the diagnostic test.

Syntax                    `:DIAG:TEST:RESult?`

Query response            `result <newline><^END>`

The data type of *result* is NR1 response data.

The *result* values have the following meaning.

SCPI Commands

**DIAGnostic Subsystem**

<b>result</b>	<b>Explanation</b>
-2	Test in progress
-1	Not complete (now pause status—waiting to continue)
0	PASS
1	FAIL
2	DONE
3	NOT DONE

Example

```
OUTPUT @Hp4155;":DIAG:TEST 101"  
OUTPUT @Hp4155;":DIAG:TEST:RES?"  
ENTER @Hp4155;A
```

---

# DISPlay Subsystem

The DISPlay subsystem controls the display conditions.

The following table is the command tree of DISPlay subsystem.

**Table 1-4. DISPlay Subsystem**

Command	Parameter
:DISPlay	
:BRIGhtness	<numeric>
:CMAP	
:COLor<n>	
:HSL	<hue>,<sat>,<lum>
:DEFault	
:CONTrast	<numeric>
[ :WINDow]	
:ALLocation	INSTRument   BASic   BStatus
[ :STATe]	0   1   OFF   ON

---

## :DISPlay:BRIGhtness

This command controls the intensity of the display.

At \*RST, this value is 0.843.

Syntax                   :DISPlay:BRIGhtness *intensity*|MINimum|MAXimum

Parameter

Parameter	Type	Explanation
<i>intensity</i>	numeric	0.15 to 1 1 is full intensity, and 0.15 is fully blanked.

Query response           *intensity* <newline><^END>

The data type of *intensity* is NR3 response data.

Example                   OUTPUT @Hp4155;":DISP:BRIG 0.5"

OUTPUT @Hp4155;":DISP:BRIG?"

ENTER @Hp4155;A

---

## :DISPlay:CMAP:COLor<n>:HSL

This command sets the instrument's color map based on the Hue/Saturation/Luminance color model.

<n> is required to specify the color numbers. Valid COLor numbers are COLor1 through COLor15.



Color Number	Explanation
1	Background
2	Softkey Background
3	Active Field Background
4	Graph Background
5	Foreground
6	Active Field Foreground
7	Title
8	Frame
9	Advisory
10	Y1 Axis
11	Y2 Axis
12	Marker/Cursor/Line
13	Active Mkr/Csr/Lne
14	Overlay
15	Grid

Syntax                   :DISPlay:CMAP:COLor<n>:HSL *hue*|MINimum|MAXimum,  
*sat*|MINimum|MAXimum, *lum*|MINimum|MAXimum

Parameter

Parameter	Type	Explanation
<i>hue</i>	numeric	Hue ranges circularly from 0 to 1 with a value of 0 resulting in the same hue as a value of 1. The approximate color progression is  starting at 0 : red, orange, yellow, green, cyan, blue, magenta, and back to red.
<i>sat</i>	numeric	Saturation is the amount of pure color to be mixed with white. The saturation value ranges from 0 to 1, with 0 specifying no color  only white or gray, depending on intensity  and 1 specifying no white.
<i>lum</i>	numeric	Luminance specifies the brightness per unit area of color. The luminance value ranges from 0 to 1. A luminance of 0 results in black; a luminance of 1 results in the brightest color variable.

Query response           *hue, sat, lum* <newline><^END>

The data type of *hue*, *sat*, and *lum* are NR3 response data.

SCPI Commands  
**DISPlay Subsystem**

Example                    OUTPUT @Hp4155;":DISP:CMAP:COlor1:HSL 0.5,0.5,0.5"  
  
                          OUTPUT @Hp4155;":DISP:CMAP:COlor1:HSL?"  
                          ENTER @Hp4155;A,B,C

---

### :DISPlay:CMAP:DEFault

This command sets the color map to the instrument's default values for all colors.

This command does not have query form.

Syntax                    :DISP:CMAP:DEFault

Example                    OUTPUT @Hp4155;":DISP:CMAP:DEF"

---

### :DISPlay:CONTRast

This command sets the contrast, which is the difference in brightness between the data and background.

AT \*RST, this value is 0.608.

Syntax                    :DISPlay:CONTRast *contrast*|MINimum|MAXimum

Parameter

Parameter	Type	Explanation
<i>contrast</i>	numeric	0 to 1 0 means no difference between data and background, and 1 means maximum contrast.

Query response                    *contrast* <newline><^END>  
 The data type of *contrast* is NR3 response data.

Example                            OUTPUT @Hp4155;":DISP:CONT 0.5"  
                                   OUTPUT @Hp4155;":DISP:CONT?"  
                                   ENTER @Hp4155;A

## :DISPlay[:WINDow]:ALLocation

This command controls the display allocation.  
 At \*RST, this value is set to "INST".

Syntax                            :DISPlay [ :WINDow ] :ALLocation INSTRument|BASic|BSTatus

Parameter

Parameter	Type	Explanation
INSTRument	character	display "All Instrument" screen
BASic	character	display "All IBASIC" screen
BSTatus	character	display "IBASIC Status" screen (instrument screen, but bottom three lines and softkeys are for IBASIC).

Query response                    INST|BAS|BST <newline><^END>

Example                            OUTPUT @Hp4155;":DISP:ALL INS"  
                                   OUTPUT @Hp4155;":DISP:ALL?"  
                                   ENTER @Hp4155;A\$

**DISPlay Subsystem**

---

**:DISPlay[:WINDow][:STATe]**

This command controls whether the instrument screen is updated or not.

AT \*RST, this value is ON.

Syntax                   :DISPlay[:WINDow][:STATe]OFF|ON|0|1

Parameter

Parameter	Type	Explanation
OFF or 0	boolean	screen is not updated
ON or 1	boolean	screen is updated

Query response           0|1 <newline><^END>

Example                   OUTPUT @Hp4155;":DISP ON"

OUTPUT @Hp4155;":DISP?"  
ENTER @Hp4155;A

---

## FORMat Subsystem

The FORMat subsystem sets a data format for transferring numeric and array information.

This data format is used for both command and response data by those commands that are specifically designated to be affected by the FORMat subsystem. The designation is either given as part of a command description, or in the definition of block or array data used by a command.

The data format for command data may override the definition of FORMat if the data received is self typing (indicates its type), for the duration of that data transfer.

The following table is the command tree of FORMat subsystem.

**Table 1-5. FORMat Subsystem**

Command	Parameter
:FORMat	
:BORDer	NORMal   SWAPped
[:DATA]	ASCii   REAL{,<length>}

---

## :FORMat:BORDER

This command controls whether binary data is transferred in normal or swapped byte order. To set up binary data transfer, you must specify **REAL** in the FORMat[:DATA] command.

At \*RST, this value is set to **NORMal**.

Syntax                   :FORMat:BORDER NORMal | SWAPped

Parameter

Parameter	Type	Explanation
NORMal	character	Normal byte order.
SWAPped	character	Swapped byte order.

Query response           NORM|SWAP <newline><^END>

Example                   OUTPUT @Hp4155;":FORM:BORD NORM"  
  
                          OUTPUT @Hp4155;":FORM:BORD?"  
                          ENTER @Hp4155;A\$

---

## :FORMat[:DATA]

This command specifies the data format, which only has meaning for the :DATA|:TRACe:DEFine and :DATA|:TRACe:STATus commands.

For other commands, the query response is usually ASCII.

At \*RST, this value is set to **ASCIi**.

Syntax                   :FORMat[:DATA]ASCIi | REAL { ,*length* }

Parameter

Parameter	Explanation
ASCIi	Numeric data is transferred as ASCII bytes in NR1, NR2, or NR3 response data format, as appropriate.
REAL	The numbers are separated by commas as specified in <i>IEEE 488.2</i> . Data is transferred in a block of <i>IEEE 754</i> floating point numbers with the specified bit <i>length</i> . Valid <i>length</i> are 32 and 64 bits. [Default is 64 bits].

Query response           ASC|REAL,*length* <newline><^END>

The data type of *length* is NR1 response data.

Example                   OUTPUT @Hp4155;":FORM ASC"

OUTPUT @Hp4155;":FORM?"

ENTER @Hp4155;A\$

---

## HCOPY Subsystem

The Hard COPY subsystem controls the print/plot function of the HP 4155A/4156A.

The following tables are the command tree of HCOpy subsystem.

**Table 1-6. HCOpy Subsystem (1 of 3)**

Command	Parameter
:HCOpy	
:ABORt	
:DATA?	
:DESTination	SERial   RDEvice   MMEMory
:DEvice	
:CMOD	BW   FULL   FIX
:COLor	0   1   OFF   ON
:LANGuage	PCL   HPGL
:RESolution	<numeric>
[:IMMediate]	
:INIT	<string>



**Table 1-7. HCOPI Subsystem (2 of 3)**

Command	Parameter
:ITEM	
:ALL	
:DATA?	
[:IMMEDIATE]	
:ANNOtation	
:STATe	0   1   OFF   ON
:ANNOtation2	
:STATe	0   1   OFF   ON
:FFEed	
:STATe	0   1   OFF   ON
:LABel	
:STATe	0   1   OFF   ON
:TEXT	<string>
:PNUMber	
:STATe	0   1   OFF   ON
:TDSamp	
:STATe	0   1   OFF   ON
[:WINDow]	
:TEXT	
:STATe	0   1   OFF   ON
:TEXT2	
:STATe	0   1   OFF   ON
:TEXT3	
:STATe	0   1   OFF   ON
:TRACe	
:DATA?	
:GRATICule	
:STATe	0   1   OFF   ON
[:IMMEDIATE]	
:STATe	0   1   OFF   ON

SCPI Commands  
**HCOPY Subsystem**

**Table 1-8. HCOpy Subsystem (3 of 3)**

<b>Command</b>	<b>Parameter</b>
:LINDEX	<numeric>, <numeric>
:OPAGE	CURRENT   GROUP   ALL
:PAGE	
:COLUMN	<numeric>
:DIMENSIONS	
:LLEFT	<numeric>, <numeric>
:QUADRANT<n>	
:URIGHT	<numeric>, <numeric>
:FDIRECTION	LSIDE   SSIDE
:LENGTH	<numeric>
:LINE	<numeric>
:SIZE	CUSTOM   A   B   A3   A4   B4   B5
:UNIT	IN   MM
:WIDTH	<numeric>
:SDUMP	
:DATA?	
[:IMMEDIATE]	
:TRAILER	<string>

---

## :HCOpy:ABORt

This command aborts the current print or plot operation.

This command does not have query form.

Syntax                   :HCOPY:ABORt

Example                 OUTPUT @Hp4155;":HCOPY:ABOR"

---

## :HCOpy:DATA?

This command returns hardcopy (PCL or HP-GL) data of the plot or print out.

The items to be returned have been selected by HCOpy:ITEM subsystem commands.

This command has query form *only*.

Syntax                   :HCOPY:DATA?

Query response         #0{*data element*} <newline><^END>

Response is in indefinite length arbitrary block response data format.

Example                 Refer to *HP 4155A/4156A Programmer's Guide*.

---

## :HCOPY:DESTination

This command selects the print or plot destination.

This command does not have query form.

This command has no \*RST state and you must use this command before printing or plotting.

Syntax                   :HCOPY:DESTination SERIAL | RDEvice | MMEMemory

Parameter

Parameter	Type	Explanation
SERial	character	RS-232-C port
RDEvice	character	HP-IB port
MMEMemory	character	diskette in the internal disk drive (file name is specified by :MMEMemory:NAME command)

Example                 OUTPUT @Hp4155;":HCOPY:DEST RDEV"

See also               :MMEMemory:NAME

---

## :HCOPY:DEvice:CMOD

This command selects color mode for hardcopy.

At \*RST, the value of this parameter is BW.

Syntax                   :HCOPY:DEvice:CMOD BW|FULL|FIX

Parameter

Parameter	Type	Explanation
BW	character	monochrome mode
FULL	character	color mode for HP-GL or PCL printers that have sixteen color capability, for example, HP DeskJet 1200C and HP PaintJet. You can make a color print that has exactly the same colors as display.
FIX	character	color mode for HP-GL pen plotters and PCL color printers that have only eight color capability, for example, HP DeskJet 500C, 550C, and 560C.

**FIX mode**

By PCL color printer, you can make a color copy that uses eight fixed colors: black, red, green, yellow, blue, magenta, cyan, and white.

You can change the color to print or pen assignment for each screen item by using the SYSTEM: COLOR SETUP page. For details, refer to "SYSTEM: COLOR SETUP page" in Chapter 4 of *HP 4155A/4156A User's Dictionary Reference*.

Although this mode allows only the eight fixed colors, this mode is also available for HP-GL or PCL printers that have sixteen color capability.

Query response

BW|FULL|FIX <newline><^END>

Example

OUTPUT @Hp4155;":HCOP:DEV:CMOD FIX"

OUTPUT @Hp4155;":HCOP:DEV:CMOD?"

ENTER @Hp4155;A\$

---

## :HCOPY:DEVICE:COLor

### NOTE

:HCOPY:DEVICE:COLor is available to keep compatibility with previous revisions (HOSTC revision 01.00 and 01.01) of ROM based firmware.

Use :HCOPY:DEVICE:CMOD instead of this command.

This command selects color or monochrome (black/white) mode.

At \*RST, the value of this parameter is OFF.

Syntax                   :HCOPY:DEVICE:COLor OFF|ON|0|1

Parameter

Parameter	Type	Explanation
OFF or 0	boolean	monochrome mode
ON or 1	boolean	color mode for the HP-GL or PCL printers which have sixteen colors capability, for example, HP DeskJet 1200C and HP PaintJet. You can get a color copy which uses exactly same colors as display.

Query response        0|1 <newline><^END>

Example                OUTPUT @Hp4155;":HCOPY:DEV:COL ON"

OUTPUT @Hp4155;":HCOPY:DEV:COL?"

ENTER @Hp4155;A

---

## :HCOPY:DEVice:LANGuage

This command selects the printer or plotter control language.

At \*RST, this value is set to PCL.

Syntax                   :HCOPY:DEVice:LANGuage PCL | HPGL

Parameter

Parameter	Type	Explanation
PCL	character	Printer Control Language [PCL]
HPGL	character	Hewlett-Packard's Graphics Language [HP-GL]

Query response           PCL|HPGL <newline><^END>

Example                   OUTPUT @Hp4155;":HCOP:DEV:LANG PCL"

OUTPUT @Hp4155;":HCOP:DEV:LANG?"  
 ENTER @Hp4155;A\$

---

## :HCOPY:DEVice:RESolution

This command sets the resolution of the print out on the printer.

This command is effective only if the printer or plotter control language is set to PCL by :HCOP:DEV:LANG command.

At \*RST, this value is set to 75 DPI.

Syntax                   :HCOPY:DEVice:RESolution *resolution* | MINimum | MAXimum

SCPI Commands  
**HCOPY Subsystem**

Parameter

Parameter	Type	Explanation
<i>resolution</i>	numeric	75, 90, 100, 150, 180, 300, 600  DPI  Suffix is not allowed.

Query response

*resolution* <newline><^END>

The data type of *resolution* is NR1 response data.

Example

```
OUTPUT @Hp4155;":HCOP:DEV:RES 75"
```

```
OUTPUT @Hp4155;":HCOP:DEV:RES?"
```

```
ENTER @Hp4155;A
```

---

## :HCOPY[:IMMEDIATE]

This command immediately initiates the plot or print according to the current setup.

The output items to be plotted or printed out are the items selected by the :HCOPY:ITEM subsystem commands.

This command does not have query form.

Syntax

```
:HCOPY[:IMMEDIATE]
```

Example

```
OUTPUT @Hp4155;":HCOP"
```



---

## HCOPY:INIT

This command sets INIT STRING, which are initialization commands you want to send to the printer or plotter.

At \*RST, this value is set to the empty string.

Syntax                   :HCOPY:INIT *init\_string*

Parameter

Parameter	Type	Explanation
<i>init_string</i>	string	initialization commands

You can specify non-printable ASCII characters by a backslash and octal code (ASCII code). For example, \033 specifies the <ESC> character.

Query response           *init\_string* <newline><^END>

Example

```
OUTPUT @Hp4155;":HCOP:INIT '\033E' "
OUTPUT @Hp4155;":HCOP:INIT?"
ENTER @Hp4155;A$
```

---

## :HCOPY:ITEM:ALL:DATA?

This command returns hardcopy (PCL or HP-GL) data of all output items, including items not selected by the :HCOPY:ITEM subsystem commands.

This command has query form *only*.

SCPI Commands  
**HCOPY Subsystem**

Syntax                   :HCOPY:ITEM:ALL:DATA?

Query response           #O{*data element*} <newline><^END>

Response is in indefinite length arbitrary block response data format.

---

### :HCOPY:ITEM:ALL[:IMMEDIATE]

This command immediately plots or prints all output items, including items not selected by the :HCOPY:ITEM subsystem commands.

This command does not have query form.

Syntax                   :HCOPY:ITEM:ALL[:IMMEDIATE]

Example                  OUTPUT @Hp4155;":HCOPY:ITEM:ALL"

---

### :HCOPY:ITEM:ANNOtation:STATe

This command sets whether the title of the print or plot out (TITLE) should be plotted or printed when the HCOPI:IMMEDIATE command or HCOPI:DATA? query is sent.

At \*RST, the value of this parameter is ON.

Syntax                   :HCOPY:ITEM:ANNOtation:STATe OFF|ON|0|1

Parameter

Parameter	Type	Explanation
OFF or 0	boolean	Title is not plotted or printed.
ON or 1	boolean	Title is plotted or printed.

Query response

0|1 <newline><^END>

Example

OUTPUT @Hp4155;":HCOP:ITEM:ANN:STAT ON"

OUTPUT @Hp4155;":HCOP:ITEM:ANN:STAT?"  
 ENTER @Hp4155;A

## :HCOPY:ITEM:ANnotation2:STATE

This command sets whether the user defined comment for each page group (USER COMMENT) should be plotted or printed when the HCOpy:IMmediate command or HCOpy:DATA? query is sent.

At \*RST, the value of this parameter is ON.

Syntax

:HCOPY:ITEM:ANnotation2:STATE OFF|ON|0|1

Parameter

Parameter	Type	Explanation
OFF or 0	boolean	USER COMMENT is not plotted or printed.
ON or 1	boolean	USER COMMENT is plotted or printed.

Query response

0|1 <newline><^END>

SCPI Commands  
**HCOPY Subsystem**

Example                    `OUTPUT @Hp4155;":HCOP:ITEM:ANN2:STAT ON"`  
  
`OUTPUT @Hp4155;":HCOP:ITEM:ANN2:STAT?"`  
`ENTER @Hp4155;A`

---

### **:HCOPY:ITEM:FFeed:STATe**

This command sets whether the printer or plotter feeds a sheet after plot or print out by the HCOPY:IMMEDIATE command or HCOPY:DATA? query.

At \*RST, the value of this parameter is OFF.

Syntax                    `:HCOPY:ITEM:FFeed:STATe OFF|ON|0|1`

Parameter

Parameter	Type	Explanation
OFF or 0	boolean	Disable form feed function
ON or 1	boolean	Enable form feed function

Query response            `0|1 <newline><^END>`

Example                    `OUTPUT @Hp4155;":HCOP:ITEM:FFE:STAT ON"`  
  
`OUTPUT @Hp4155;":HCOP:ITEM:FFE:STAT?"`  
`ENTER @Hp4155;A`

---

## :HCOPY:ITEM:LABEL:STATE

This command sets whether the user defined comment for the plot or print out (PRINT/PLOT COMMENT), which is defined by :HCOPY:ITEM:LABEL:TEXT command, should be plotted or printed when the :HCOPY:IMMEDIATE command or :HCOPY:DATA? query is sent.

At \*RST, the value of this parameter is ON.

Syntax                   :HCOPY:ITEM:LABEL:STATE OFF|ON|0|1

Parameter

Parameter	Type	Explanation
OFF or 0	boolean	PRINT/PLOT COMMENT is not plotted or printed.
ON or 1	boolean	PRINT/PLOT COMMENT is plotted or printed.

Query response           0|1 <newline><^END>

Example                   OUTPUT @Hp4155;":HCOP:ITEM:LAB:STAT ON"

OUTPUT @Hp4155;":HCOP:ITEM:LAB:STAT?"  
 ENTER @Hp4155;A

See also                 :HCOPY:ITEM:LABEL:TEXT

---

## :HCOPY:ITEM:LABEL:TEXT

This command defines the user defined comment for the plot or print out (PRINT/PLOT COMMENT).

If the PRINT/PLOT COMMENT is an empty string, it will be plotted or printed as a single blank line.

SCPI Commands  
**HCOPY Subsystem**

At \*RST, this comment is set to empty string.

Syntax                   :HCOPY:ITEM:LABel:TEXT *string*

Parameter

Parameter	Type	Explanation
<i>string</i>	string	PRINT/PLOT COMMENT

Query response

*string* <newline><^END>

Example

```
OUTPUT @Hp4155;" :HCOP:ITEM:LAB:TEXT 'DEVICE:AAA NO.123456'"  
  
OUTPUT @Hp4155;" :HCOP:ITEM:LAB:TEXT?"  
ENTER @Hp4155;A$
```

---

## :HCOPY:ITEM:TDSTamp:STATe

This command sets whether the present date and time of the built-in clock (DATE&TIME) should be plotted or printed when the HCOPI:IMMEDIATE command or HCOPI:DATA? query is sent.

At \*RST, the value of this parameter is ON.

Syntax                   :HCOPY:ITEM:TDSTamp:STATe OFF|ON|0|1

Parameter

Parameter	Type	Explanation
OFF or 0	boolean	DATE&TIME is not plotted or printed.
ON or 1	boolean	DATE&TIME is plotted or printed.

Query response            O|1 <newline><^END>

Example                    OUTPUT @Hp4155;":HCOP:ITEM:TDST:STAT ON"  
                               OUTPUT @Hp4155;":HCOP:ITEM:TDST:STAT?"  
                               ENTER @Hp4155;A

## :HCOPY:ITEM:PNUMBER:STATE

This command sets whether the page number of the plot or print out (PAGE NO.) should be plotted or printed when the HCOPI:IMMEDIATE command or HCOPI:DATA? query is sent.

At \*RST, the value of this parameter is ON.

This command does not comply with SCPI.

Syntax                    :HCOPY:ITEM:PNUMBER:STATE OFF|ON|0|1

Parameter

Parameter	Type	Explanation
OFF or 0	boolean	PAGE NO is not plotted or printed.
ON or 1	boolean	PAGE NO is plotted or printed.

Query response            O|1 <newline><^END>

Example                    OUTPUT @Hp4155;":HCOP:ITEM:PNUM:STAT ON"  
                               OUTPUT @Hp4155;":HCOP:ITEM:PNUM:STAT?"  
                               ENTER @Hp4155;A

---

## :HCOPY:ITEM[:WINDow]:TEXT:STATe

This command sets whether the GRAPH TEXT (marker and cursor coordinate values, data variables, and line parameters) should be plotted or printed when the HCOPY:IMMEDIATE command or HCOPY:DATA? query is sent.

At \*RST, the value of this parameter is ON.

Syntax                   :HCOPY:ITEM[:WINDow]:TEXT:STATe OFF|ON|0|1

Parameter

Parameter	Type	Explanation
OFF or 0	boolean	GRAPH TEXT is not plotted or printed.
ON or 1	boolean	GRAPH TEXT is plotted or printed.

This command has meaning only when :HCOPY:DEVICE:LANGUage is set to HP-GL. If set to PCL, GRAPH TEXT is always printed or plotted.

Query response           0|1 <newline><^END>

Example                   OUTPUT @Hp4155;":HCOP:ITEM:TEXT:STAT ON"  
  
                          OUTPUT @Hp4155;":HCOP:ITEM:TEXT:STAT?"  
                          ENTER @Hp4155;A

---

## :HCOPY:ITEM[:WINDow]:TEXT2:STATe

This command sets whether the GRAPH AXIS TEXT (names, units, and scale of the graph axis) should be plotted or printed when the HCOPY:IMMEDIATE command or HCOPY:DATA? query is sent.

At \*RST, the value of this parameter is ON.



This command does not comply with SCPI.

Syntax                   :HCOPY:ITEM[:WINDow]:TEXT2:STATe OFF|ON|0|1

Parameter

Parameter	Type	Explanation
OFF <i>or</i> 0	boolean	GRAPH AXIS TEXT is not plotted or printed.
ON <i>or</i> 1	boolean	GRAPH AXIS TEXT is plotted or printed.

This command has meaning only when :HCOPY:DEVIce:LANGUage is set to HP-GL. If set to PCL, GRAPH AXIS TEXT is always printed or plotted.

Query response           0|1 <newline><^END>

Example                   OUTPUT @Hp4155;":HCOP:ITEM:TEXT2:STAT ON"

OUTPUT @Hp4155;":HCOP:ITEM:TEXT2:STAT?"  
 ENTER @Hp4155;A

## :HCOPY:ITEM[:WINDow]:TEXT3:STATe

This command sets whether the measurement setup data should be plotted or printed when the HCOPI:IMMediate command or HCOPI:DATA? query is sent to output graphics results.

At \*RST, the value of this parameter is OFF.

This command does not comply with SCPI.

Syntax                   :HCOPY:ITEM[:WINDow]:TEXT3:STATe OFF|ON|0|1

SCPI Commands  
**HCOPY Subsystem**

Parameter

Parameter	Type	Explanation
OFF or 0	boolean	Measurement setup data is not plotted or printed.
ON or 1	boolean	Measurement setup data is plotted or printed.

Query response

0|1 <newline><^END>

Example

OUTPUT @Hp4155;" :HCOP:ITEM:TEXT3:STAT ON"

OUTPUT @Hp4155;" :HCOP:ITEM:TEXT3:STAT?"

ENTER @Hp4155;A

## :HCOPY:ITEM[:WINDow]:TRACe:DATA?

This command returns hardcopy (PCL or HP-GL) data of the graphics plot curve on the GRAPH/LIST: GRAPHICS page.

This command also changes the current display to GRAPH/LIST: GRAPHICS page.

This command has query form *only*.

Syntax

:HCOPY:ITEM[:WINDow]:TRACe:DATA?

Query response

#0{*data element*} <newline><^END>

Response is in indefinite length arbitrary block response data format.

Example

Refer to *HP 4155A/4156A Programmer's Guide*

---

## **:HCOPY:ITEM[:WINDow]:TRACe:GRATicule:STATe**

This command sets whether the frame and grid on the GRAPH/LIST: GRAPHICS page (GRAPH FRAME&GRID) should be plotted or printed when the HCOPY:IMMediate command or HCOPY:DATA? query is sent.

At \*RST, the value of this parameter is **ON**.

Syntax `:HCOPY:ITEM[:WINDow]:TRACe:GRATicule:STATe OFF|ON|0|1`

Parameter

Parameter	Type	Explanation
OFF or 0	boolean	GRAPH FRAME&GRID is not plotted or printed.
ON or 1	boolean	GRAPH FRAME&GRID is plotted or printed.

This command has meaning only when :HCOPY:DEVIce:LANGUage is set to HP-GL. If set to PCL, GRAPH FRAME&GRID is always printed or plotted.

Query response `0|1 <newline><^END>`

Example `OUTPUT @Hp4155;":HCOP:ITEM:TRAC:GRAT:STAT ON"`

```
OUTPUT @Hp4155;":HCOP:ITEM:TRAC:GRAT:STAT?"
ENTER @Hp4155;A
```

---

## **:HCOPY:ITEM[:WINDow]:TRACe[:IMMediate]**

This command immediately plots or print outs the graphics plot curve of the GRAPH/LIST: GRAPHICS page.

This command also changes the current display to GRAPH/LIST: GRAPHICS page.

SCPI Commands  
**HCOPY Subsystem**

This command does not have query form.

Syntax                   :HCOPY:ITEM[:WINDow]:TRACe[:IMMediate]

Example                 OUTPUT @Hp4155;":HCOP:ITEM:TRAC"

---

**:HCOPY:ITEM[:WINDow]:TRACe:STATE**

This command sets whether the graphics plot curve on the GRAPH/LIST: GRAPHICS page (GRAPH TRACE) should be plotted or printed when the HCOpy:IMMediate command or HCOpy:DATA? query is sent.

At \*RST, the value of this parameter is ON.

Syntax                   :HCOPY:ITEM[:WINDow]:TRACe:STATe OFF|ON|0|1

Parameter

Parameter	Type	Explanation
OFF or 0	boolean	GRAPH TRACE is not plotted or printed.
ON or 1	boolean	GRAPH TRACE is plotted or printed.

This command has meaning only when :HCOPY:DEvIce:LANGUage is set to HP-GL. If set to PCL, GRAPH TRACE is always printed or plotted.

Query response         0|1 <newline><^END>

Example                 OUTPUT @Hp4155;":HCOP:ITEM:TRAC:STAT ON"

OUTPUT @Hp4155;":HCOP:ITEM:TRAC:STAT?"  
ENTER @Hp4155;A

---

## :HCOPY:LINDEX

This command specifies the range of measurement results to output by using index numbers.

You use this command only if the current display page is GRAPH/LIST: LIST.

This command also changes the value of :MMEMory:STORe:SSHeet:LINDEX.

At \*RST, this value is set to (1,MAX).

This command does not comply with SCPI.

Syntax                               :HCOPY:LINDEX *first* | MINimum | MAXimum, *last* | MINimum | MAXimum

Parameter

Parameter	Type	Explanation
<i>first</i>	numeric	first index number to output
<i>last</i>	numeric	last index number to output

Query response                    *first, last* <newline><^END>

The data type of *first* and *last* are NR1 response data.

Example                            OUTPUT @Hp4155; ":HCOP:LIND 1,MAX"

```
OUTPUT @Hp4155; ":HCOP:LIND?"
ENTER @Hp4155; A,B
```

See also                           :MMEMory:STORe:SSHeet:LINDEX

---

## :HCOPY:OPAGE

This command sets the range of the setup data to be output.

SCPI Commands  
**HCOPY Subsystem**

At \*RST, this value is set to CURRent.

Syntax                   :HCOPY:OPAGe CURRent | GROup | ALL

Parameter

Parameter	Type	Explanation
CURR	character	setup data of <i>only the page</i> where the print/plot function is invoked.
GRO	character	setup data of the <i>page group</i> where the print/plot function is invoked.
ALL	character	all setup data.

Query response       CURR|GRO|ALL <newline><^END>

Example               OUTPUT @Hp4155;":HCOP:OPAG CURR"  
  
                      OUTPUT @Hp4155;":HCOP:OPAG?"  
                      ENTER @Hp4155;A\$

---

## :HCOPY:PAGE:COLumn

This command sets the number of characters (columns) in one line of the print out.

At \*RST, the value of this parameter is 80.

Syntax                   :HCOPY:PAGE:COLumn *column*

Parameter

Parameter	Type	Explanation
<i>column</i>	numeric	number of characters in a line.

Query response            *column* <newline><^END>  
 The data type of *column* is NR1 response data.

Example                    OUTPUT @Hp4155;":HCOP:PAGE:COL 80"  
                               OUTPUT @Hp4155;":HCOP:PAGE:COL?"  
                               ENTER @Hp4155;A

See also                    :HCOPY:DEVICE:LANGUage

## :HCOPY:PAGE:DIMENSIONS:LLEFT

This command sets the lower left corner of the output region.  
 At \*RST, the value of this parameter is (0,0).

Syntax                     :HCOPY:PAGE:DIMENSIONS:LLEFT *x*|MINimum|MAXimum,  
                               *y*|MINimum|MAXimum

Parameter

Parameter	Type	Explanation
<i>x</i>	numeric	percentage from the left side of the paper
<i>y</i>	numeric	percentage from the bottom of the paper

Query response            *x*, *y* <newline><^END>  
 The data type of *x* and *y* are NR3 response data.

Example                    OUTPUT @Hp4155;":HCOP:PAGE:DIM:LLEF 10, 90"  
                               OUTPUT @Hp4155;":HCOP:PAGE:DIM:LLEF?"  
                               ENTER @Hp4155;A,B

---

## **:HCOPY:PAGE:DIMensions:QUADrant<n>**

This command sets LOWER LEFT and UPPER RIGHT so that the setup data is printed on the upper right quarter, upper left quarter, lower left quarter, or lower right quarter of the page.

A numeric suffix is required to specify the quadrant.

<b>&lt;n&gt;</b>	<b>quadrant</b>
1	upper right quarter
2	upper left quarter
3	lower left quarter
4	lower right quarter

This command defines an event and thus has no \*RST state or query form.

Syntax                    **:HCOPY:PAGE:DIMensions:QUADrant<n>**

Example                    **OUTPUT @Hp4155;":HCOPY:PAGE:DIM:QUAD1"**

See also                    **:HCOPY:PAGE:DIMensions:LLEFt, :HCOPY:PAGE:DIMensions:URIGHt**

---

## **:HCOPY:PAGE:DIMensions:URIGHt**

This command sets the upper right corner of the output region.

At \*RST, the value of this parameter is (100,100).

Syntax                    **:HCOPY:PAGE:DIMensions:URIGHt *x, y***



Parameter

Parameter	Explanation
<i>x</i>	percentage from the left side of the paper
<i>y</i>	percentage from the bottom of the paper

Query response

*x*, *y* <newline><^END>

The data type of *x* and *y* are NR3 response data.

Example

OUTPUT @Hp4155;":HCOP:PAGE:DIM:URIG 90, 10"

OUTPUT @Hp4155;":HCOP:PAGE:DIM:URIG?"  
 ENTER @Hp4155;A,B

## :HCOPY:PAGE:FDIRrection

This command sets the direction of the paper-feed into the plotter.

At \*RST, the value of this parameter is **SSIDe**.

Syntax

:HCOPY:PAGE:FDIRrection SSIDe | LSIDe

Parameter

Parameter	Explanation
SSIDe	character Direction is shorter side of the paper
LSIDe	character Direction is longer side of the paper

Query response

SSID|LSID <newline><^END>

SCPI Commands  
**HCOPY Subsystem**

Example                    OUTPUT @Hp4155;":HCOP:PAGE:FDIR SSID"  
  
                          OUTPUT @Hp4155;":HCOP:PAGE:FDIR?"  
                          ENTER @Hp4155;A\$

---

### :HCOPY:PAGE:LENGth

This command sets the vertical length of the paper.  
Unit of length is set by :HCOPY:PAGE:UNIT command.  
At \*RST, the value of this parameter is set to 11 inch.

Syntax                    :HCOPY:PAGE:LENGth *length* | MINimum | MAXimum

Parameter

Parameter	Explanation
<i>length</i>	numeric vertical length of the paper 7 to 20  inch  or 177.793 to 507.98  mm

Query response           *length* <newline><^END>

The data type of *length* is NR3 response data.

Example                    OUTPUT @Hp4155;":HCOP:PAGE:LENG 10"  
  
                          OUTPUT @Hp4155;":HCOP:PAGE:LENG?"  
                          ENTER @Hp4155;A

See also :HCOPY:PAGE:UNIT

---

## :HCOPY:PAGE:LINE

This command sets the number of lines on a page.

At \*RST, the value of this parameter is 60.

This command does not comply with SCPI.

Syntax :HCOPY:PAGE:LINE *length*

Parameter

Parameter	Type	Explanation
<i>line</i>	numeric	number of lines on a page

Query response *line* <newline><^END>

Example OUTPUT @Hp4155;":HCOP:PAGE:LINE 60"

OUTPUT @Hp4155;":HCOP:PAGE:LINE?"  
 ENTER @Hp4155;A

See also :HCOPY:DEVIce:LANGUage

---

## :HCOPY:PAGE:SIZE

This command sets the paper size.

If :HCOPY:PAGE:LENGth or :HCOPY:PAGE:WIDth are set, the value of this setting becomes CUSTom.

SCPI Commands  
**HCOPY Subsystem**

At \*RST, the value of this parameter is CUSTom.

Syntax                   :HCOPY:PAGE:SIZE CUSTom | A | B | A3 | A4 | B4 | B5

Parameter

Parameter	Type	Explanation
CUSTom	character	size is defined by LENGth and WIDTH
A,B,A3,A4,B4,B5	character	A,B,A3,A4,B4,B5 size

Query response

CUST|A|B|A3|A4|B4|B5 <newline><^END>

A (letter) = 8.5 by 11 in, B = 11 by 17 in, A3 = 297 by 420 mm  
A4 = 210 by 297 mm, B4 = 257 by 364 mm, B5 = 182 by 257 mm.

Example

OUTPUT @Hp4155;" :HCOPY:PAGE:SIZE A4"

OUTPUT @Hp4155;" :HCOPY:PAGE:SIZE?"

ENTER @Hp4155;A\$

See also

:HCOPY:PAGE:LENGth, :HCOPY:PAGE:WIDTH

---

## :HCOPY:PAGE:UNIT

This command sets the unit for LENGth and WIDTH.

At \*RST, the value of this parameter is IN (inch).

Syntax

:HCOPY:PAGE:UNIT IN | MM

Parameter

Parameter	Type	Explanation
IN	character	inch
MM	character	millimeter

Query response

IN|MM <newline><^END>

Example

OUTPUT @Hp4155;":HCOP:PAGE:UNIT IN"

OUTPUT @Hp4155;":HCOP:PAGE:UNIT?"  
 ENTER @Hp4155;A\$

See also

:HCOPYy:PAGE:LENGTh, :HCOPYy:PAGE:WIDTh

---

## :HCOPY:PAGE:WIDTH

This command sets the horizontal width of the paper.  
Unit of width is set by :HCOPY:PAGE:UNIT command.  
At \*RST, the value of this parameter is set to 8.5 inch.

Syntax                   :HCOPY:PAGE:WIDTH *width*

Parameter

Parameter	Type	Explanation
<i>width</i>	numeric	width of the paper

Query response         *width* <newline><^END>

The data type of *width* is NR3 response data.

Example                 OUTPUT @Hp4155;" :HCOP:PAGE:WIDT 10"  
  
                          OUTPUT @Hp4155;" :HCOP:PAGE:WIDT?"  
                          ENTER @Hp4155;A

See also               :HCOPY:PAGE:UNIT

---

## :HCOPY:SDUMp:DATA?

This command returns hardcopy (PCL or HP-GL) data of the current screen image.

This command has query form *only*.

Syntax                   :HCOPY:SDUMp:DATA?

Query response           #0{*data element*} <newline><^END>

Response is in indefinite length arbitrary block response data format.

Example                 Refer to *HP 4155A/4156A Programmer's Guide*

---

### :HCOPY:SDUMp[:IMMEDIATE]

This command plots or prints out the current screen image.

This command does not have query form.

Syntax                   :HCOPY:SDUMp[:IMMEDIATE]

Example                 OUTPUT @Hp4155;":HCOPY:SDUM"

---

## :HCOPY:TRAILer

This command sets the TRAILER STRING, which are the commands you want to send to the printer or plotter after printing or plotting.

At \*RST, this value is set to the empty string.

Syntax                    :HCOPY:TRAILer *trailer\_string*

Parameter

Parameter	Type	Explanation
<i>trailer_string</i>	string	trailer string

You can specify non-printable ASCII characters by backslash and octal code (ASCII code). For example, \033 specifies the <ESC> character.

Query response           *trailer\_string* <newline><^END>

Example                    OUTPUT @Hp4155;":HCOP:TRA '\033E'"  
  
                          OUTPUT @Hp4155;":HCOP:TRAILER?"  
                          ENTER @Hp4155;A\$



# MMEMemory Subsystem

The MMEMemory (Mass MEmory) subsystem provides mass storage capabilities.

HP 4155A/4156A has two mass memory devices: internal disk (DISK) and internal memory (MEMORY). But the internal memory is a restricted mass memory device, which has only four fixed names (MEM1, MEM2, MEM3, MEM4) and their file extensions for data type (MES, STR, or DAT).

The following table is a command tree of MMEMemory subsystem.

**Table 1-9. MMEMemory Subsystem**

Command	Parameter
:MMEMemory	
:CATalog?	[<msus>]
:COpy	<file_name>, <file_name>   <file_name>, <msus>, <file_name>, <msus>
:DELeTe	<file_name> [,<msus>]
:INITialize	{LIF   DOS}
:LOAD	
:STATe	<state_no>, <file_name> [,<msus>]
:TRACe	<label>, <file_name> [,<msus>]
:MOVE	<file_name>, <file_name>   <file_name>, <msus>, <file_name>, <msus>
:NAME	<file_name> [,<msus>]
:STORe	
:SSHeet	<file_name>
:DELimiter	SPACE   TAB   COMMA
:LINDEX	<numeric>, <numeric>
:SMARK	NONE   DQuote   SQuote
:UNIT	OFF   ON   0   1
:STATe	<state_no>, <file_name> [,<msus>]
:TRACe	<label>, <file_name> [,<msus>]

---

## :MMEMory:CATalog?

This command returns information about the present contents and state of the mass storage media that is in the internal disk drive.

Syntax                    :MMEMory:CATalog? [*msus*]

Parameter

Parameter	Type	Explanation
<i>msus</i>	string	mass storage  DISK only

Query response

*used,available* { *,file\_entry\_list* } <newline><^END>

The *used* indicates the remaining amount of storage currently used in bytes. The data type of *used* is NR1 response data.

The *available* indicates the remaining amount of storage available in bytes. The data type of *available* is NR1 response data.

The *file\_entry\_list* is a list of *file\_entries* separated by commas. The data type of *file\_entry\_list* is string response data format, but does not contain double quote characters at the beginning and end of the string.

Each *file\_entry* indicates the name, type, and size of one file.

*file\_entry* = *file\_name*, *file\_type*, *file\_size*

The *file\_name* is the name of a file including the extension.

The *file\_size* is the size of the file in bytes.

The *file\_type* is indicated by one of the following:

- ASC—ASCII text file
- BIN—binary file
- STAT—instrument (setting) state
- TRAC—trace (display) data
- MACR—instrument macro

The following is the example of the *file\_entry\_list*:

BTR.MES,STAT,3833,GENE.MES,STAT,3833,VDS-ID.MES,STAT,3833

Example                    OUTPUT @Hp4155;" :MMEM:CAT?"  
                              ENTER @Hp4155;A,B,C\$

## :MMEMory:COPY

This command copies an existing file to a new file.

If the source file doesn't exist or the destination file already exists, an error is generated.

This command does not have query form.

Syntax                    :MMEMory:COPY *src\_file*, *dest\_file*

or

:MMEMory:COPY *src\_file*,*src\_msus*, *dest\_file*,*dest\_msus*

Parameter

Parameter	Type	Explanation
<i>src_file</i>	string	source file name including extension
<i>dest_file</i>	string	destination file name including extension
<i>src_msus</i>	string	source mass storage  DISK or MEMORY
<i>dest_msus</i>	string	destination mass storage  DISK or MEMORY

The default mass storage is the internal disk (DISK). You must specify file extension with the file name.

If the specified mass storage device is MEMORY, the extension is optional, so file name can be MEM1, MEM2, MEM3, or MEM4 or with applicable file type extension (MES, STR, or DAT).

**MMEMory Subsystem**

Example

```
OUTPUT @Hp4155;":MMEM:COPY 'CMOS.MES', 'CMOS2.MES'"
```

```
OUTPUT @Hp4155;":MMEM:COPY 'CMOS.MES','DISK', 'MEM3.MES', 'MEMORY'"
```

**:MMEMory:DELeTe**

This command removes a file from the specified mass storage device.

This command does not have query form.

Syntax

```
:MMEMory:DELeTe file_name [ ,msus ]
```

Parameter

Parameter	Type	Explanation
<i>file_name</i>	string	file name including extension
<i>msus</i>	string	mass storage  DISK or MEMORY

The default mass storage is the internal disk (DISK).

If the specified mass storage device is **MEMORY**, the file name must be **MEM1**, **MEM2**, **MEM3**, or **MEM4** with file type extension (**MES**, **STR**, or **DAT**).

Example

```
OUTPUT @Hp4155;":MMEM:DEL 'CMOS.MES'"
```

```
OUTPUT @Hp4155;":MMEM:DEL 'MEM3.MES', 'MEMORY'"
```

**:MMEMory:INITialize**

This command initializes the diskette that is in the internal disk drive.

This command does not have query form.

Syntax                   :MMEMory:INITialize { DOS|LIF }

Parameter

Parameter	Type	Explanation
DOS	character	MS-DOS format
LIF	character	LIF format

The default setting is "DOS".

Example

OUTPUT @Hp4155;":MMEM:INIT DOS"

## :MMEMory:LOAD:STATe

This command loads the specified setup data from the specified mass memory device.

This command does not have query form.

Syntax                   :MMEMory:LOAD:STATe *state\_no*, *file\_name* [ ,*msus* ]

Parameter

Parameter	Type	Explanation
<i>state_no</i>	numeric	no meaning for HP 4155A/56A 0 is recommended
<i>file_name</i>	string	file name.
<i>msus</i>	string	mass storage  DISK or MEMORY

The default mass storage is the internal disk (DISK).

If the specified mass storage device is MEMORY, the extension is optional, so file name can be MEM<n>.MES, MEM<n>.STR, or MEM<n>, where <n> = 1, 2, 3, or 4.

**MMEMory Subsystem**

If the specified mass storage device is **DISK**, the file name must have extension (MES, STR, or CST).

Example                    `OUTPUT @Hp4155;":MMEM:LOAD:STAT 0, 'CMOS.MES'`

**:MMEMory:LOAD:TRACe**

This command loads the measurement data from specified mass memory device.

This command defines does not have query form.

Syntax                    `:MMEMory:LOAD:TRACe label, file_name [ ,msus ]`

Parameter

Parameter	Type	Explanation
<i>label</i>	character	DEfault only
<i>file_name</i>	string	file name.
<i>msus</i>	string	mass storage  DISK or MEMORY

The default mass storage is the internal disk (**DISK**).

If the specified mass storage device is **MEMORY**, the extension is optional, so file name can be **MEM<n>.DAT** or **MEM<n>**, where <n> = 1, 2, 3, or 4.

If the specified mass storage device is **DISK**, the file name must have extension (DAT).

Example                    `OUTPUT @Hp4155;":MMEM:LOAD:TRAC DEF, 'CMOS.DAT'`

`OUTPUT @Hp4155;":MMEM:LOAD:TRAC DEF, 'MEM1.DAT', 'MEMORY'`

---

## :MMEMory:MOVE

This command moves (renames) an existing file to another file name.

Both the source and destination files must be on the internal disk.

If the specified source file does not exist, error -256 "File name not found" will be generated.

If the specified destination file already exists, error -257 "File name error" will be generated.

This command does not have query form.

Syntax                                :**MMEMory:MOVE** *src\_file* ,*dest\_file*

or

                                     :**MMEMory:MOVE** *src\_file* ,*src\_msus* , *dest\_file* ,*dest\_msus*

Parameter

Parameter	Type	Explanation
<i>src_file</i>	string	source file name including extension
<i>dest_file</i>	string	destination file name including extension
<i>src_msus</i>	string	source mass storage  DISK only
<i>dest_msus</i>	string	destination mass storage  DISK only

Example                                OUTPUT @Hp4155;" :**MMEM:MOVE** 'CMOS.MES' , 'CMOS2.MES'"

---

## :MMEMory:NAME

This command sets the name of the file to be used by the HCOPY subsystem.

When the destination of hard copy is MMEMory (mass memory), the hard copy data is saved to the diskette file specified by this command.

**MMEMory Subsystem**

AT \*RST, this value is a null string.

Syntax                   :MMEMory:NAME *file\_name* [ ,*msus* ]

Parameter

Parameter	Type	Explanation
<i>file_name</i>	string	file name
<i>msus</i>	string	mass storage  DISK only

Query response

*file\_name* <newline><^END>

The data type of *file\_name* is string response data, but does not contain double quote characters at the beginning and end of the string.

Example

OUTPUT @Hp4155;" :MMEM:NAME 'DUMPFILe' "

OUTPUT @Hp4155;" :MMEM:NAME?"

ENTER @Hp4155;A\$

See also

HCOPY:DESTination

---

## :MMEMory:STORe:SSHeet

This command stores the result data (ASCII format) to a diskette file. This file can be used in a spreadsheet. See the following commands for how to store the data.

This command does not have query form.

Syntax

:MMEMory:STORe:SSHeet *file\_name*



Parameter

Parameter	Type	Explanation
<i>file_name</i>	string	file name

Example

OUTPUT @Hp4155;":MMEM:STOR:SSH 'ASCData'"

## :MMEMory:STORe:SSHeet:DELimiter

This command specifies the data delimiter (that separates result data) to use in the spreadsheet file that is created by :MMEMory:STORe:SSHeet command.

At \*RST, this value is SPAC.

Syntax

:MMEMory:STORe:SSHeet:DELimiter SPACe|TAB|COMMa

Parameter

Parameter	Type	Explanation
SPACe	character	space
TAB	character	tab
COMMa	character	comma

Query response

SPAC|TAB|COMM <newline><^END>

Example

OUTPUT @Hp4155;":MMEM:STOR:SSH:DEL TAB"

## :MMEMory:STORe:SSHeet:LINDeX

This command specifies the range of measurement results to store in the spreadsheet file that is created by :MMEMory:STORe:SSHeet command.

**MMEMemory Subsystem**

This command changes the value of :HCOPY:LINDEX.

At \*RST, this value is (1,MAX).

Syntax                   :MMEMory:STORe:SSHeet:LINDEX *first*|MINimum|MAXimum,  
*last*|MINimum|MAXimum

Parameter

Parameter	Type	Explanation
<i>first</i>	numeric	first index number to output
<i>last</i>	numeric	last index number to output

Query response           *first, last* <newline><^END>

The data type of *first* and *last* are NR1 response data.

Example                   OUTPUT @Hp4155;":MMEM:STOR:SSH:LIND 1,MAX"

```
OUTPUT @Hp4155;":MMEM:STOR:SSH:LIND?"
ENTER @Hp4155;A,B
```

See also                   :HCOPY:LINDEX

---

## :MMEMory:STORe:SSHeet:SMARK

This command specifies the string mark to use in the spreadsheet file that is created by :MMEMory:STORe:SSHeet command.

At \*RST, this value is NONE.

Syntax                   :MMEMory:STORe:SSHeet:SMARK NONE|DQuote|SQuote

Parameter

Parameter	Type	Explanation
NONE	character	no string mark
DQQuote	character	double quotes
SQQuote	character	single quotes

Query response

NONE|DQU|SQU <newline><^END>

Example

OUTPUT @Hp4155;":MMEM:STOR:SSH:SMARK DQU"

## :MMEMory:STORe:SSHeet:UNIT

This command specifies whether to include units with result data in the spreadsheet file created by :MMEMory:STORe:SSHeet command.

At \*RST, this value is OFF.

Syntax

:MMEMory:STORe:SSHeet:UNIT OFF|ON|0|1

Parameter

Parameter	Type	Explanation
OFF or 0	boolean	do not include units
ON or 1	boolean	include units

Query response

0|1 <newline><^END>

**MMEMory Subsystem**

Example                    `OUTPUT @Hp4155;":MMEM:STOR:SSH:UNIT ON"`

---

## :MMEMory:STORe:STATe

This command stores the specified type of setup data to the specified mass memory device.

This command defines an event and thus has no \*RST state or query form.

Syntax                    `:MMEMory:STORe:STATe state_no, file_name [ ,msus ]`

Parameter

Parameter	Type	Explanation
<i>state_no</i>	numeric	no meaning for HP 4155A/4156A 0 is recommended
<i>file_name</i>	string	file name must have extension  MES, STR, or CST  which specifies type of setup data.
<i>msus</i>	string	mass storage  DISK or MEMORY

The default mass storage is the internal disk (DISK). For disk, you must specify an extension with the file name.

If the specified mass storage device is MEMORY, file name must be MEM1, MEM2, MEM3, or MEM4 with applicable file extension MES or STR.

Example                    `OUTPUT @Hp4155;":MMEM:STOR:STAT 0,'CMOS.MES'"`

`OUTPUT @Hp4155;":MMEM:STOR:STAT 0,'MEM1.MES','MEMORY'"`

---

## :MMEMory:STORe:TRACe

This command stores the measurement setup and results to the specified mass memory device.

This command does not have query form.

Syntax                                :MMEMory:STORe:TRACe *label*, *file\_name* [ ,*msus* ]

Parameter

Parameter	Type	Explanation
<i>label</i>	character	DEfault only
<i>file_name</i>	string	file name
<i>msus</i>	string	mass storage  DISK or MEMORY

The default mass storage is the internal disk (DISK).

If the specified mass storage device is DISK, the file name must have extension (DAT).

If the specified mass storage device is MEMORY, the extension is optional, so file name can be MEM<n>.DAT or MEM<n>, where <n> = 1, 2, 3, or 4.

Example                                OUTPUT @Hp4155;":MMEM:STOR:TRAC DEF,'CMOS.DAT'"

OUTPUT @Hp4155;":MMEM:STOR:TRAC DEF,'MEM1.DAT','MEMORY'"

---

## PAGE Subsystem

The PAGE subsystem commands are divided into several sections. Each command sets the fields of the “fill in the blank” user interface pages.

The hierarchy of the PAGE subsystem command is similar to the user interface page structure, except for the SCONtrol Subsystem.

The SCONtrol Subsystem controls the state of HP 4155A/4156A, such as measurement, stress forcing, standby, and idle.

The SYSTEM group page functions are not implemented in the PAGE subsystem. These functions are controlled by other subsystems, such as MMEMory and HCOPY.

The following table shows the relation between the upper level keywords of the PAGE Subsystem and the user interface pages. Basically the first level keywords correspond to the *page group*, and the second level keywords correspond to the *page name*.

**Table 1-10. PAGE Subsystem Command Hierarchy and User Interface Pages**

Command Hierarchy	User Interface Page Name
:PAGE	
:CHANnels	
[:CDEFinition]	CHANNELS: CHANNEL DEFINITION
:UFUNction	CHANNELS: USER FUNCTION DEFINITION
:UVARiable	CHANNELS: USER VARIABLE DEFINITION
:MEASure	
[:SWEep]	MEASURE: SWEEP SETUP
:SAMPLing	MEASURE: SAMPLING SETUP
:PGUSetup	MEASURE: PGU SETUP
:MSETup	MEASURE: MEASURE SETUP
:OSEQuence	MEASURE: OUTPUT SEQUENCE
:DISPlay	
[:SETup]	DISPLAY: DISPLAY SETUP
:ANALysis	DISPLAY: ANALYSIS SETUP
:GLISt	
[:GRAPhics]	GRAPH/LIST: GRAPHICS
:LIST	GRAPH/LIST: LIST
:STress	
[:CDEFinition]	STRESS: CHANNEL DEFINITION
:SETup	STRESS: STRESS SETUP
:FORCe	STRESS: STRESS FORCE
:KSweep	KNOB SWEEP
:SYSTem	for changing pages only, not setting.
:FILer	SYSTEM: FILER
:MISC	SYSTEM: MISCELLANEOUS
:CONFig	SYSTEM: CONFIGURATION
:CDIagnostic	SYSTEM: SELF-CALIBRATION/DIAGNOSTICS
:PRINt	SYSTEM: PRINT/PLOT SETUP
:COLor	SYSTEM: COLOR SETUP
:SCONtrol	STATE CONTROL

SCPI Commands  
**PAGE Subsystem**

The following tables are the lower level command tree of PAGE subsystem.

**Table 1-11. CHANNELS: CHANNEL DEFINITION page (1 of 2)**

Command	Parameter
:CHANnels	
[:CDEFinition]	
:ALL	
:DISable	
:COMment	<string>
:DEFault	
[:MENU]	
:MODE	SWEep   SAMpling
:PGU(1 2)	
:DISable	
:MODE	V   VPULse
:STANdby	0   1   OFF   ON
:VNAME	<name>
:SMU(1 2 3 4 5 6)	
:DISable	
:FUNCTion	VAR1   VAR2   VARD   CONStant
:INAME	<name>
:MODE	V   I   VPULse   IPULse   COMMOn
:SRESistance	0 10K 100K 1M
:STANdby	0   1   OFF   ON
:VNAME	<name>
:VMU(1 2)	
:DISable	
:MODE	V   DVOLt
:VNAME	<name>



**CHANNELS: CHANNEL DEFINITION page (2 of 2)**

Command	Parameter
:VSU(1 2)	
:DISable	
:FUNction	VAR1   VAR2   VARD   CONStant
:MODE?	
:STANdby	0   1   OFF   ON
:VNAME	<name>
:GNDU	
:DISable	
:MODE?	
:VNAME	<name>

**Table 1-12. CHANNELS: USER FUNCTION DEFINITION page**

Command	Parameter
:CHANnels	
:UFUNction	
:CATalog?	
:DEFine	<name>, <unit>, <definition>
:DELete	
[:NAME]	<name>
:ALL	
[:MENU]	

SCPI Commands  
**PAGE Subsystem**

**Table 1-13. CHANNELS: USER VARIABLE DEFINITION page**

Command	Parameter
:CHANnels	
:UVAriable	
:CATalog?	
:DEFine	<name>, <unit>, <size>
:DELete	
[:NAME]	<name>
:ALL	
[:MENU]	

**Table 1-14. MEASURE: SWEEP SETUP page (1 of 2)**

Command	Parameter
:MEASure	
[:SWEep]	
:CONStant	
:SMU(1 2 3 4 5 6)	
[:SOURce]	<numeric_value>
:COMPLiance	<numeric_value>
:VSU(1 2)	
[:SOURce]	<numeric_value>
:DELay	<numeric_value>
:HTIME	<numeric_value>
[:MENU]	
:PULSe	
:PERiod	<numeric_value>
:WIDTh	<numeric_value>
:BASE	<numeric_value>
:SSTop	ABNormal   COMPLiance   OFF
:VAR1	
:COMPLiance	<numeric_value>
:MODE	SINGle   DOUBle
:PCOMpliance	<numeric_value>
:STATe	0   OFF
:SPACing	LINear   L10   L25   L50
:STARt	<numeric_value>
:STEP	<numeric_value>
:STOP	<numeric_value>

SCPI Commands  
**PAGE Subsystem**

**Table 1-15. MEASURE: SWEEP SETUP page (2 of 2)**

Command	Parameter
:VAR2	
:COMPLIance	<numeric_value>
:PCOMPLIance	<numeric_value>
:STATe	0   OFF
:POINTs	<numeric_value>
:START	<numeric_value>
:STEP	<numeric_value>
:VARD	
:COMPLIance	<numeric_value>
:OFFSet	<numeric_value>
:PCOMPLIance	<numeric_value>
:STATe	0   OFF
:RATIo	<numeric_value>

**Table 1-16. MEASURE: SAMPLING SETUP page**

Command	Parameter
:MEASure	
:SAMPling	
:CONStant	
:SMU(1 2 3 4 5 6)	
:COMPLiance	<numeric_value>
[:SOURce]	<numeric_value>
:VSU(1 2)	
[:SOURce]	<numeric_value>
:HTIME	<numeric_value>
:IINTerval	<numeric_value>
[:MENU]	
:MODE	LINear   L10   L25   L50   THINnedout
:PERiod	<numeric_value>   INFIinity
:AUTO	0   1   OFF   ON
:POINts	<numeric_value>
:SCONdition	
:ECOUNT	<numeric_value>
:EVENT	LOW   HIGH   ABSLow   ABSHigh
:HOFF	<numeric_value>
:NAME	<var_name>
[:STATe]	0   1   OFF   ON
:THReshold	<numeric_value>

SCPI Commands  
**PAGE Subsystem**

**Table 1-17. MEASURE: PGU SETUP page**

Command	Parameter
:MEASure	
:PGUSetup	
:CONStant	
:PGU(1 2)	
[:SOURce]	<numeric_value>
[:MENU]	
:PULSe	
:PGU(1 2)	
:BASE	<numeric_value>
:COUNt	<numeric_value>
:DELay	<numeric_value>
:IMPedance	LOW   R50
:LEADing	<numeric_value>
:PEAK	<numeric_value>
:PERiod	<numeric_value>
:TRAILing	<numeric_value>
:WIDTh	<numeric_value>

**Table 1-18. MEASURE: MEASUREMENT SETUP page**

Command	Parameter
:MEASure	
:MSETup	
[:MENU]	
:ITime	
:LONG	
:APERTure?	
[:NPLCycles]	<numeric_value>
:MEDium	
:APERTure?	
:NPLCycles?	
[:MODE]	SHORT   LONG   MEDium
:SHORT	
[:APERTure]	<numeric_value>
:NPLCycles?	
:SMU(1 2 3 4 5 6)	
:RANGe	<numeric_value>
:MODE	AUTO   FIXEd   LIMited
:VMU(1 2)	
:RANGe	<numeric_value>
:MODE	AUTO   FIXEd   LIMited
:WTime	<numeric_value>
:ZCANcel	
:SMU(1 2 3 4 5 6)?	
[:STATe]	0   1   OFF   ON
:VMU(1 2)?	

SCPI Commands  
**PAGE Subsystem**

**Table 1-19. MEASURE: OUTPUT SEQUENCE page**

Command	Parameter
:MEASure	
:OSEQUence	
[:MENU]	
:MODE	SEQuential   SIMultaneous
:OSEQUence	< unit > {,< unit >}   DEFault
:TRIGger	
:FUNCTion	INPut   OUTPut
:POLarity	POSitive   NEGative
[:STATe]	0   1   OFF   ON
:TIME	<numeric_value>



**Table 1-20. DISPLAY: DISPLAY SETUP page (1 of 2)**

Command	Parameter
:DISPlay	
[:SETup]	
:DVARiable	
[:SElect]	<var_name> {,< var_name>}
:DElete	
:ALL	
[:NAME]	<name>
[:MENU]	
:MODE	GRAPhics   LIST
:GRAPhics	
:GRID	0   1   OFF   ON
:LPARam	0   1   OFF   ON
:X	
:DElete	
:MAX	<numeric_value>
:MIN	<numeric_value>
:NAME	<var_name>
:SCALe	LINear   LOGarithmic
:Y1	
:DElete	
:MAX	<numeric_value>
:MIN	<numeric_value>
:NAME	<var_name>
:SCALe	LINear   LOGarithmic
:Y2	
:DElete	
:MAX	<numeric_value>
:MIN	<numeric_value>
:NAME	<var_name>
:SCALe	LINear   LOGarithmic

SCPI Commands  
**PAGE Subsystem**

**DISPLAY: DISPLAY SETUP page (2 of 2)**

Command	Parameter
:LIST	
[:SElect]	<var_name> {,<var_name>}
:DElete	
:ALL	
[:NAME]	<name>

**Table 1-21. DISPLAY: AUTO ANALYSIS SETUP page**

Command	Parameter
:DISPlay	
:ANALysis	
:INTerpolate	0   1   OFF   ON
:LINE(1 2)	
:GRADient	<expr>
:MODE	NORMal   GRADient   TANGent   REGReSSion   DISable
:POINt(1 2)	
:AFTer	<var_name>, <expr>
:STATe	0   1   OFF   ON
:MODE	XY   OPLot
:POSition	<var_name>, <expr>
:X	<expr>
:Y	<expr>
:TANGent	
:AFTer	<var_name>, <expr>
:STATe	0   1   OFF   ON
:POSition	<var_name>, <expr>
:YAXis	Y1   Y2
:MARKer	
:AFTer	<var_name>, <expr>
:STATe	0   1   OFF   ON
:DISable	
:POSition	<var_name>, <expr>
[:MENU]	

SCPI Commands  
**PAGE Subsystem**

**Table 1-22. GRAPH/LIST: GRAPHICS page (1 of 2)**

Command	Parameter
:GLIST	
[:GRAPhics]	
:AAAnalysis	
:ASElect	Y1   Y2
:CURSor	
:DIRect	
:X	<numeric_value>
:Y1	<numeric_value>
:Y2	<numeric_value>
[:STATe]	OFF   SHORt   LONG
:DISPlay	
:DVARiable	0   1   OFF   ON
:GRID	0   1   OFF   ON
:LPARam	0   1   OFF   ON
:OVERlay	
:PLANe	0   1   2   3   4   OFF
:SINFo	0   1   OFF   ON
:STOVerlay	
:INTerpolate	0   1   OFF   ON
:LINE	
[:STATe]	OFF   ON
:LSElect	NONE   LINE1   LINE2   1   2
:MODE	NORMAl   GRADient   TANGent   REGREssion
:GRADient	<numeric_value>
:CTMARker	
:SCURsorCPOint	

**Table 1-23. GRAPH/LIST: GRAPHICS page (2 of 2)**

Command	Parameter
:MARKer	
:DIRect	
:X	<numeric_value>
:Y1	<numeric_value>
:Y2	<numeric_value>
:LIMit	
:SKIP	
[:STATe]	0   1   OFF   ON
[:MENU]	
:SCALing	
:AUTO	ONCE
:ZOOM	IN   OUT
:CENTer	
:CANCel	
:CTMarker	

**Table 1-24. GRAPH/LIST: LIST page**

Command	Parameter
:GLISt	
:LIST	
:ASELect	Y1   Y2
:MARKer	
:DIRect	INDEX   <var_name>, <numeric_value>
:SKIP	
[:STATe]	0   1   OFF   ON
[:MENU]	

SCPI Commands  
**PAGE Subsystem**

**Table 1-25. STRESS: CHANNEL DEFINITION page (1 of 2)**

Command	Parameter
:STress	
:CDEfinition	
:ALL	
:DISable	
:COMment	<string>
:GNDU	
:DISable	
:FUNCTion?	
:MODE?	
:NAME	<name>
[:MENU]	
:PGU(1 2)	
:DISable	
:FUNCTion	SYNC   NSYNc
:MODE	V   VPULse
:NAME	<name>
:SMU(1 2 3 4 5 6)	
:DISable	
:FUNCTion	SYNC   NSYNc
:MODE	V   I   COMMOn
:NAME	<name>
:VSU(1 2)	
:DISable	
:FUNCTion	SYNC   NSYNc
:MODE?	
:NAME	<name>
:SElector(1 2 3 4)	
:MEASure	SMU   PGU   OPEN   POPen
:STress	SMU   PGU   OPEN   POPen

**STRESS: CHANNEL DEFINITION page (2 of 2)**

Command	Parameter
:TRIGger	
:POLarity	POSitive   NEGative
[:STATe]	0   1   OFF   ON

SCPI Commands  
**PAGE Subsystem**

**Table 1-26. STRESS: STRESS SETUP page**

Command	Parameter
:STress	
:SETup	
:ACCumulate	RESet   <numeric_value>
:CONStant	
:PGU(1 2)	
[:SOURce]	<numeric_value>
:SMU(1 2 3 4 5 6)	
:COMPLiance	<numeric_value>
[:SOURce]	<numeric_value>
:VSU(1 2)	
[:SOURce]	<numeric_value>
:DURation	<numeric_value>
:FILTer	0   1   OFF   ON
:HTIME	<numeric_value>
[:MENU]	
:MODE	PCOunt   DURation
:PCOunt	<numeric_value>
:PULSe	
:PGU(1 2)	
:BASE	<numeric_value>
:DELay	<numeric_value>
:IMPedance	LOW   R50
:LEADing	<numeric_value>
:PEAK	<numeric_value>
:PERiod	<numeric_value>
:TRAIling	<numeric_value>
:WIDTh	<numeric_value>
:SSTop	ABNormal   COMPLiance   OFF



**Table 1-27. STRESS: STRESS FORCE page**

Command	Parameter
:STress	
:FORCE	
:ACCumulate	RESet
[:MENU]	
:STATus	RESet

SCPI Commands  
**PAGE Subsystem**

**Table 1-28. KNOB SWEEP page**

Command	Parameter
:KSweep	
:CURSor	
:X	<numeric_value>
:Y	<numeric_value>
:DISPlay	
:DIRection	
:X	NORMAl   REVerse
:Y	NORMAl   REVerse
:GRID	0   1   OFF   ON
:REGion	
:X	POSitive   NEGative   BIPolar
:Y	POSitive   NEGative   BIPolar
[:MENU]	
:SCOPy	
:VAR1	
:EXTent	<numeric_value>
:MODE	SINGLe   DOUBle
:POLarity	POSitive   NEGative   BIPolar
:POINts	<numeric_value>
:RANGe	<numeric_value>
:STIME	<numeric_value>
:Y	<var_name>

**Table 1-29. SYSTEM page group**

Command	Parameter
:SYSTem	
:CDIagnostic	
[:MENU]	
:COLor	
[:MENU]	
:CONFig	
[:MENU]	
:FILer	
[:MENU]	
:MISC	
[:MENU]	
:PRINt	
[:MENU]	

SCPI Commands  
**PAGE Subsystem**

**Table 1-30. STATE CONTROL**

Command	Parameter
:SCONtrol	
:KSWeep	
[:STARt]	
[:MEASurement]	
:APPend	
:REPeat	
:SINGle	
:STANdby	0   1   OFF   ON
:STATe?	
:STOP	
:STress	
[:STARt]	
:TRIGger	
:INPUt?	POSitive   NEGative   EITHer
:OUTPUt	
[:PULSe]	POSitive   NEGative
:LEVel	HIGH   LOW
:ZERO	

---

## :PAGE:CHANnels[:CDEFinition]:ALL:DISable

This command deletes the settings of all units (SMU,VSU,VMU,PGU,GNDU).  
 This command does not have query form.

Syntax                   :PAGE:CHANnels[:CDEFinition]:ALL:DISable

Example                   OUTPUT @Hp4155;":PAGE:CHAN:ALL:DIS"

---

## :PAGE:CHANnels[:CDEFinition]:COMMeNT

This command sets the USER DEFINED COMMENT for the measurement group.

At \*RST, a comment is not defined.

Syntax                   :PAGE:CHANnels[:CDEFinition]:COMMeNT *comment*

Parameter

Parameter	Type	Explanation
<i>comment</i>	string	String of up to 58 characters.

Query response           *comment* <newline><^END>

*comment* is string response data.

Example                   OUTPUT @Hp4155;":PAGE:CHAN:COMM 'V-I curve'"

OUTPUT @Hp4155;":PAGE:CHAN:COMM?"  
 ENTER @Hp4155;A\$

---

## **:PAGE:CHANnels[:CDEFinition]:DEFault**

This command sets the measurement and stress setup to the same state as after \*RST is executed.

This command does not affect the setup parameters of SYSTEM page group except the following:

PRINT SETUP      all settings  
COLOR SETUP      PLOTTER PEN NO.  
MISCELLANEOUS    COMMAND SET

This command does not have query form.

Syntax                    **:PAGE:CHANnels [ :CDEFinition ] :DEFault**

Example                    **OUTPUT @Hp4155; ":PAGE:CHAN:DEF"**

---

## **:PAGE:CHANnels[:CDEFinition]:GNDU:DISable**

This command deletes the settings of GNDU.

This command does not have query form.

Syntax                    **:PAGE:CHANnels [ :CDEFinition ] :GNDU:DISable**

Example                    **OUTPUT @Hp4155; ":PAGE:CHAN:GNDU:DIS"**

---

## :PAGE:CHANnels[:CDEFinition]:GNDU:MODE?

This command returns the output MODE of GNDU.

This command has query form *only*.

Syntax                   :PAGE:CHANnels[:CDEFinition]:GNDU:MODE?

Query response           COMM|DIS <newline><^END>

When the GNDU is not used, the response data may be DIS (DISable).

Example                   OUTPUT @Hp4155;":PAGE:CHAN:GNDU:MODE?"  
                           ENTER @Hp4155;A\$

---

## :PAGE:CHANnels[:CDEFinition]:GNDU:VNAME

This command sets the VNAME of GNDU.

At \*RST, this value is not defined.

Syntax                   :PAGE:CHANnels[:CDEFinition]:GNDU:VNAME *name*

Parameter

Parameter	Type	Explanation
<i>name</i>	string	String of up to 6 alphanumeric characters.
	string	1st character must be alphabet.

Query response           *name* <newline><^END>

*name* is string response data, but does not contain double quote characters at the beginning and end of the string.

**PAGE Subsystem**

Example                    `OUTPUT @Hp4155;":PAGE:CHAN:GNDU:VNAME 'VD' "`  
                           `OUTPUT @Hp4155;":PAGE:CHAN:GNDU:VNAME?"`  
                           `ENTER @Hp4155;A$`

**:PAGE:CHANnels[:CDEFinition][:MENU]**

This command changes the present display page to “CHANNELS: CHANNEL DEFINITION” page.

This command does not have query form.

Syntax                    `:PAGE:CHANnels [ :CDEFinition ] [ :MENU ]`

Example                    `OUTPUT @Hp4155;":PAGE:CHAN"`

**:PAGE:CHANnels[:CDEFinition]:MODE**

This command sets the MEASUREMENT MODE.

At \*RST, this value is set to **SWEEp**.

Syntax                    `:PAGE:CHANnels [ :CDEFinition ] :MODE SWEEp|SAMPling`

Parameter

Parameter	Type	Explanation
SWEEp	character	sweep measurement mode
SAMPling	character	sampling measurement mode



Query response            **SWE|SAMP <newline><^END>**

Example                    **OUTPUT @Hp4155;":PAGE:CHAN:MODE SWEEP"**  
  
**OUTPUT @Hp4155;":PAGE:CHAN:MODE?"**  
**ENTER @Hp4155;A\$**

---

### **:PAGE:CHANnels[:CDEFinition]:SMU<n>:DISable**

This command deletes the settings of SMU<n>.

<n> is required to specify SMU number. Valid SMU numbers are SMU1 through SMU6, depending on the configuration.

This command does not have query form.

Syntax                    **:PAGE:CHANnels[:CDEFinition]:SMU<n>:DISable**

Example                    **OUTPUT @Hp4155;":PAGE:CHAN:SMU1:DIS"**

---

### **:PAGE:CHANnels[:CDEFinition]:SMU<n>:FUNction**

This command sets the function (FCTN) of SMU<n>.

<n> is required to specify SMU number. Valid SMU numbers are SMU1 through SMU6, depending on the configuration.

At \*RST, this value is:

SCPI Commands  
**PAGE Subsystem**

SMU	FUNCTION
SMU1	CONSTant
SMU2	VAR2
SMU3	VAR1
SMU4	CONSTant
SMU5 and SMU6	not defined

Syntax                   :PAGE:CHANnels [ :CDEFinition ] :SMU<n>:FUNctIon  
VAR1|VAR2|VARD|CONSTant

Parameter

Parameter	Type	Explanation
VAR1	character	VAR1 function
VAR2	character	VAR2 function
VARD	character	VAR1' function
CONSTant	character	constant

Query response

VAR1|VAR2|VARD|CONS|DIS <newline><^END>

If SMU is not used, the response data may be DIS (DISable).

Example

OUTPUT @Hp4155;":PAGE:CHAN:SMU1:FUNC VAR1"

OUTPUT @Hp4155;":PAGE:CHAN:SMU1:FUNC?"

ENTER @Hp4155;A\$

---

## :PAGE:CHANnels[:CDEFinition]:SMU<n>:INAMe

This command sets the INAME of SMU<n>.

<n> is required to specify SMU number. Valid SMU numbers are SMU1 through SMU6, depending on the configuration.

At \*RST, this value is:

SMU	INAME
SMU1 through SMU4	I<n>
SMU5 and SMU6	not defined

Syntax                    :PAGE:CHANnels[:CDEFinition]:SMU<n>:INAME *name*

Parameter

Parameter	Type	Explanation
<i>name</i>	string	String of up to 6 alphanumeric characters. 1st character must be alphabet.

Query response            *name* <newline><^END>

*name* is string response data, but does not contain double quote characters at the beginning and end of the string.

Example

```
OUTPUT @Hp4155;":PAGE:CHAN:SMU1:INAME 'ID'"
OUTPUT @Hp4155;":PAGE:CHAN:SMU1:INAME?"
ENTER @Hp4155;A$
```

---

## :PAGE:CHANnels[:CDEFinition]:SMU<n>:MODE

This command sets the output MODE of SMU<n>.

<n> is required to specify SMU number. Valid SMU numbers are SMU1 through SMU6, depending on the configuration.

At \*RST, this value is:

SMU	OUTPUT MODE
SMU1	COMMon
SMU2	I
SMU3 and SMU4	V
SMU5 and SMU6	not defined.

Syntax                   :PAGE:CHANnels[:CDEFinition]:SMU<n>:MODE  
V|I|VPULse|IPULse|COMMon

Parameter

Parameter	Type	Explanation
V	character	voltage output mode
I	character	current output mode
VPULse	character	voltage pulse output mode
IPULse	character	current pulse output mode
COMMon	character	common

Query response           V|I|VPUL|IPUL|COMM|DIS <newline><^END>

If SMU is not used, the response data may be DIS (DISable).

Example                   OUTPUT @Hp4155;":PAGE:CHAN:SMU1:MODE V"

OUTPUT @Hp4155;":PAGE:CHAN:SMU1:MODE?"  
ENTER @Hp4155;A\$

---

**:PAGE:CHANnels[:CDEFinition]:SMU<n>  
:SRESistance**

This command sets the SERIES RESISTANCE of SMU<n>.

<n> is required to specify SMU number. Valid SMU numbers are SMU1 through SMU6, depending on the configuration.

At \*RST, this value is 0OHM.

Syntax                    :**PAGE:CHAN**nels[:**CDEF**inition]:SMU<n>:**SRES**istance  
*resistance*|**MIN**imum|**MAX**imum

Parameter

Parameter	Type	Explanation
<i>resistance</i>	numeric	0 1E4 1E5 1E6

You can use the suffix of OHM, KOHM, and MOHM.

Query response           *resistance* <newline><^END>

*resistance* is NR3 response data type.

Example

```
OUTPUT @Hp4155;":PAGE:CHAN:SMU1:SRES 1E4"
OUTPUT @Hp4155;":PAGE:CHAN:SMU1:SRES 10KOHM"
OUTPUT @Hp4155;":PAGE:CHAN:SMU1:SRES 1MOHM"
OUTPUT @Hp4155;":PAGE:CHAN:SMU1:SRES MAX"
OUTPUT @Hp4155;":PAGE:CHAN:SMU1:SRES?"
ENTER @Hp4155;A
OUTPUT @Hp4155;":PAGE:CHAN:SMU1:SRES? MAX"
ENTER @Hp4155;A
```

---

## **:PAGE:CHANnels[:CDEFinition]:SMU<n>:STANdby**

This command sets the standby (STBY) function of SMU<n>.

<n> is required to specify SMU number. Valid SMU numbers are SMU1 through SMU6, depending on the configuration.

At \*RST, standby function is OFF.

Syntax                    **:PAGE:CHANnels [ :CDEFinition ] :SMU<n>:STANdby OFF|ON|0|1**

Parameter

<b>Parameter</b>	<b>Type</b>	<b>Explanation</b>
OFF <i>or</i> 0	boolean	standby function is OFF
ON <i>or</i> 1	boolean	standby function is ON

Query response            **0|1 <newline><^END>**

Example                    **OUTPUT @Hp4155;":PAGE:CHAN:SMU1:STANDBY ON"**

**OUTPUT @Hp4155;":PAGE:CHAN:SMU1:STANDBY?"**  
**ENTER @Hp4155; A**

---

## :PAGE:CHANnels[:CDEFinition]:SMU<n>:VNAME

This command sets the VNAME of SMU<n>.

<n> is required to specify SMU number. Valid SMU numbers are SMU1 through SMU6, depending on the configuration.

At \*RST, this value is:

SMU	VNAME
SMU1 through SMU4	V<n>
SMU5 and SMU6	not defined

Syntax                    :PAGE:CHANnels[:CDEFinition]:SMU<n>:VNAME *name*

Parameter

Parameter	Type	Explanation
<i>name</i>	string	String of up to 6 alphanumeric characters. 1st character must be alphabet.

Query response            *name* <newline><^END>

*name* is string response data, but does not contain double quote characters at the beginning and end of the string.

Example

```
OUTPUT @Hp4155;":PAGE:CHAN:SMU1:VNAME 'VD'"
OUTPUT @Hp4155;":PAGE:CHAN:SMU1:VNAME?"
ENTER @Hp4155;A$
```

---

## **:PAGE:CHANnels[:CDEFinition]:VMU<n>:DISable**

This command deletes the settings of VMU<n>.

<n> is required to specify VMU number. Valid VMU numbers are VMU1 through VMU2.

This command does not have query form.

Syntax                    **:PAGE:CHANnels [ :CDEFinition ] :VMU<n>:DISable**

Example                   **OUTPUT @Hp4155;":PAGE:CHAN:VMU1:DIS"**

---

## **:PAGE:CHANnels[:CDEFinition]:VMU<n>:MODE**

This command sets the MODE of VMU<n>.

<n> is required to specify VMU number. Valid VMU numbers are VMU1 through VMU2.

At \*RST, this value is V.

Syntax                    **:PAGE:CHANnels [ :CDEFinition ] :VMU<n>:MODE V|DVOLt**

Parameter

<b>Parameter</b>	<b>Type</b>	<b>Explanation</b>
V	character	voltage measurement mode
DVOLt	character	differential voltage measurement mode

Query response           **V|DVOL|DIS <newline><^END>**

If VMU is not used, the response data may be DIS (DISable).



Example                    OUTPUT @Hp4155;":PAGE:CHAN:VMU1:MODE V"  
                           OUTPUT @Hp4155;":PAGE:CHAN:VMU1:MODE?"  
                           ENTER @Hp4155;A\$

---

### :PAGE:CHANnels[:CDEFinition]:VMU<n>:VNAME

This command sets the VNAME of VMU<n>.

<n> is required to specify VMU number. Valid VMU numbers are VMU1 through VMU2.

At \*RST, this value is VMU<n>.

Syntax                    :PAGE:CHANnels[:CDEFinition]:VMU<n>:VNAME *name*

Parameter

Parameter	Type	Explanation
<i>name</i>	string	String of up to 6 alphanumeric characters. 1st character must be alphabet.

Query response            *name* <newline><^END>

*name* is the string response data, but does not contain double quote characters at the beginning and end of the string.

Example                    OUTPUT @Hp4155;":PAGE:CHAN:VMU1:VNAME 'VD'"  
                           OUTPUT @Hp4155;":PAGE:CHAN:VMU1:VNAME?"  
                           ENTER @Hp4155;A\$

---

## **:PAGE:CHANnels[:CDEFinition]:VSU<n>:DISable**

This command deletes the settings of VSU<n>.

<n> is required to specify VSU number. Valid VSU numbers are VSU1 through VSU2.

This command does not have query form.

Syntax                   **:PAGE:CHANnels [ :CDEFinition ] :VSU<n>:DISable**

Example                   **OUTPUT @Hp4155;":PAGE:CHAN:VSU1:DIS"**

---

## **:PAGE:CHANnels[:CDEFinition]:VSU<n>:FUNCTion**

This command sets the function (FCTN) of VSU<n>.

<n> is required to specify VSU number. Valid VSU numbers are VSU1 through VSU2.

At \*RST, this value is CONStant.

Syntax                    **:PAGE:CHANnels[:CDEFinition]:VSU<n>:FUNCTion**  
**VAR1|VAR2|VARD|CONStant**

Parameter

<b>Parameter</b>	<b>Type</b>	<b>Explanation</b>
VAR1	character	VAR1 function
VAR2	character	VAR2 function
VARD	character	VAR1' function
CONStant	character	constant

Query response            **VAR1|VAR2|VARD|CONS|DIS <newline><^END>**

If VSU is not used, the response data may be DIS (DISable).

Example

```

OUTPUT @Hp4155;":PAGE:CHAN:VSU:FUNC VAR1"

OUTPUT @Hp4155;":PAGE:CHAN:VSU:FUNC?"
ENTER @Hp4155;A$

```

---

**:PAGE:CHANnels[:CDEFinition]:VSU<n>:MODE?**

This command returns the output MODE of VSU<n>.

<n> is required to specify VSU number. Valid VSU numbers are VSU1 through VSU2.

This command has query form *only*.

Syntax                   :PAGE:CHANnels [ :CDEFinition ] :VSU<n>:MODE?

Query response           V|DIS <newline><^END>

When the specified VSU is not used, the response data may be DIS (DISable).

Example                   OUTPUT @Hp4155;" :PAGE:CHAN:VSU1:MODE?"  
                          ENTER @Hp4155;A\$

---

## **:PAGE:CHANnels[:CDEFinition]:VSU<n>:STANdby**

This command sets the standby (STBY) function of VSU<n>.

<n> is required to specify VSU number. Valid VSU numbers are VSU1 through VSU2.

At \*RST, standby function is OFF.

Syntax                    **:PAGE:CHANnels[:CDEFinition]:VSU<n>:STANdby OFF|ON|0|1**

Parameter

<b>Parameter</b>	<b>Type</b>	<b>Explanation</b>
OFF or 0	boolean	standby function is OFF
ON or 1	boolean	standby function is ON

Query response            **0|1 <newline><^END>**

Example

```
OUTPUT @Hp4155;":PAGE:CHAN:VSU1:STANDBY ON"
OUTPUT @Hp4155;":PAGE:CHAN:VSU1:STANDBY?"
ENTER @Hp4155; A
```

---

## **:PAGE:CHANnels[:CDEFinition]:VSU<n>:VNAME**

This command sets the VNAME of VSU<n>.

<n> is required to specify VSU number. Valid VSU numbers are VSU1 through VSU2.

At \*RST, this value is VSU<n>.

Syntax                    **:PAGE:CHANnels [ :CDEFinition ] :VSU<n>:VNAME *name***

Parameter

Parameter	Type	Explanation
<i>name</i>	string	String of up to 6 alphanumeric characters. 1st character must be alphabet.

Query response

*name* <newline><^END>

*name* is the string response data, but does not contain double quote characters at the beginning and end of the string.

Example

```
OUTPUT @Hp4155;":PAGE:CHAN:VSU1:VNAME 'VD' "
```

```
OUTPUT @Hp4155;":PAGE:CHAN:VSU1:VNAME?"
```

```
ENTER @Hp4155;A$
```

---

## **:PAGE:CHANnels[:CDEFinition]:PGU<n>:DISable**

This command deletes the settings of PGU<n>.

<n> is required to specify PGU number. Valid PGU numbers are PGU1 through PGU2.

This command does not have query form.

Syntax                   :PAGE:CHANnels[:CDEFinition]:PGU<n>:DISable

Example                 OUTPUT @Hp4155;":PAGE:CHAN:PGU1:DIS"

### :PAGE:CHANnels[:CDEFinition]:PGU<n>:MODE

This command sets the output MODE of PGU<n>.

<n> is required to specify PGU number. Valid PGU numbers are PGU1 through PGU2.

At \*RST, this value is not defined.

Syntax                   :PAGE:CHANnels[:CDEFinition]:PGU<n>:MODE V|VPULse

Parameter

Parameter	Type	Explanation
V	character	voltage output mode
VPULse	character	voltage pulse output mode

Query response         V|VPUL|DIS <newline><^END>

If PGU is not used, the response data may be DIS (DISable).

Example                 OUTPUT @Hp4155;":PAGE:CHAN:PGU1:MODE VPUL"

```
OUTPUT @Hp4155;":PAGE:CHAN:PGU1:MODE?"
ENTER @Hp4155;A$
```

---

## **:PAGE:CHANnels[:CDEFinition]:PGU<n>:STANdby**

This command sets the standby (STBY) function of PGU<n>.

<n> is required to specify PGU number. Valid PGU numbers are PGU1 through PGU2.

At \*RST, this value is OFF.

Syntax                    **:PAGE:CHANnels [ :CDEFinition ] :PGU<n>:STANdby OFF|ON|0|1**

Parameter

<b>Parameter</b>	<b>Type</b>	<b>Explanation</b>
OFF <i>or</i> 0	boolean	standby function is OFF
ON <i>or</i> 1	boolean	standby function is ON

Query response            **0|1 <newline><^END>**

Example                    **OUTPUT @Hp4155;":PAGE:CHAN:PGU1:STANDBY ON"**  
  
**OUTPUT @Hp4155;":PAGE:CHAN:PGU1:STANDBY?"**  
**ENTER @Hp4155; A**

---

## **:PAGE:CHANnels[:CDEFinition]:PGU<n>:VNAME**

This command sets the VNAME of PGU<n>.

<n> is required to specify PGU number. Valid PGU numbers are PGU1 through PGU2.

At \*RST, this value is not defined.



Syntax                   :PAGE:CHANnels[:CDEFinition]:PGU<n>:VNAME *name*

Parameter

Parameter	Type	Explanation
<i>name</i>	string	String of up to 6 alphanumeric characters. 1st character must be alphabet.

Query response

*name* <newline><^END>

*name* is string response data, but does not contain double quote characters at the beginning and end of the string.

Example

```
OUTPUT @Hp4155;":PAGE:CHAN:PGU1:VNAME 'VD'"
OUTPUT @Hp4155;":PAGE:CHAN:PGU1:VNAME?"
ENTER @Hp4155;A$
```

## :PAGE:CHANnels:UFUNction:CATalog?

This query command returns the number of and a list of currently defined functions.

This command has query form *only*.

Syntax

:PAGE:CHANnels:UFUNction:CATalog?

Query response

*num\_function, function\_list* <newline><^END>

*num\_function* is a numeric value, which is the number of user defined functions. The data type is NR1 response data.

*function\_list* is a list of the user function names separated by commas. The data type is string response data, but does not contain double quote characters at the beginning and end of the string.

SCPI Commands  
**PAGE Subsystem**

Example                    OUTPUT @Hp4155;" :PAGE:CHAN:UFUN:CAT?"  
                          ENTER @Hp4155;A,B\$

---

## :PAGE:CHANnels:UFUNction:DEFine

This command defines the USER FUNCTION.

If the specified function name already exists, this command overwrites the old data with the newly defined data.

If the specified function name does not exist, the new name appears in the uppermost blank field on the CHANNELS:USER FUNCTION DEFINITION page.

A maximum of six user functions can be defined. If this limit is exceeded, **Unable to define more than 6 User functions. error (-182)** is generated.

At \*RST, all defined functions are deleted.

Syntax                    :PAGE:CHANnels:UFUNction:DEFine *name, unit, definition*

For query:

:PAGE:CHANnels:UFUNction:DEFine? *name*

Parameter

Parameter	Type	Explanation
<i>name</i>	string	String of up to 6 alphanumeric characters. 1st character must be alphabet.
<i>unit</i>	string	String of up to 6 alphanumeric characters. The null string is allowed.
<i>definition</i>	string	expression

Query response            *unit, definition* <newline><^END>

*unit* and *definition* are string response data, but do not contain double quote characters at the beginning and end.

Example                    OUTPUT @Hp4155;":PAGE:CHAN:UFUN:DEF 'VTH','V','@L1X'"  
                           OUTPUT @Hp4155;":PAGE:CHAN:UFUN:DEF? 'VTH'"  
                           ENTER @Hp4155;A\$

### :PAGE:CHANnels:UFUNction:DELeTe:ALL

This command deletes all specified USER FUNCTIONS, and frees the associated data area.

This command does not have query form.

Syntax                    :PAGE:CHANnels:UFUN:DEL:ALL

Example                    OUTPUT @Hp4155;":PAGE:CHAN:UFUN:DEL:ALL"

### :PAGE:CHANnels:UFUNction:DELeTe[:NAME]

This command deletes the specified USER FUNCTION, and frees the function name and its data area for use by another definition.

This command does not have query form.

Syntax                    :PAGE:CHANnels:UFUNction:DELeTe[:NAME]*name*

Parameter

Parameter	Type	Explanation
<i>name</i>	string	defined user function name

SCPI Commands  
**PAGE Subsystem**

Example                    `OUTPUT @Hp4155;":PAGE:CHAN:UFUN:DEL 'VD' "`

---

### `:PAGE:CHANnels:UFUNction[:MENU]`

This command changes the present display page to CHANNELS: USER FUNCTION DEFINITION page.

This command does not have query form.

Syntax                    `:PAGE:CHANnels:UFUNction[:MENU]`

Example                    `OUTPUT @Hp4155;":PAGE:CHAN:UFUN"`

---

### `:PAGE:CHANnels:UVAriable:CATalog?`

This query command returns the number and list of currently defined user variables.

This command has query form *only*.

Syntax                    `:PAGE:CHANnels:UVAriable:CATalog?`

Query response            `num_variable,variable_name_list <newline><^END>`

*num\_variable* is NR1 response data.

*variable\_name\_list* is a list of the user variable names separated by commas. The data type is string response data, but does not contain double quote characters at beginning and end of the string.

Example                    OUTPUT @Hp4155;":PAGE:CHAN:UVAR:CAT?"  
                           OUTPUT @Hp4155;A,B\$

## :PAGE:CHANnels:UVAriable:DEFine

This command defines the name, size, and unit of a user variable. This command is the same as the :DATA|:TRACe:DEFINE command. To assign data to the user variable, you use the DATA:|TRACe[:DATA] command.

If the specified user variable already exists, this command redefines the user variable with the new parameters.

A maximum of six user variables can be defined.

At \*RST, no user variables are defined.

Syntax                    :PAGE:CHANnels:UVAriable:DEFine *name,unit,size*

Parameter

Parameter	Type	Explanation
<i>name</i>	string	up to 6 alphanumeric characters The 1st character must be an alphabet.
<i>unit</i>	string	up to 6 alphanumeric characters The null string is allowed.
<i>size</i>	numeric	1 to 10001

Query response            *unit,size* <newline><^END>

*unit* is string response data, but does not contain double quote characters at beginning and end of the string.

*size* is NR1 response data.

**PAGE Subsystem**

Example                    `OUTPUT @Hp4155;":PAGE:CHAN:UVAR:DEF 'VTH','V',1001"`

`OUTPUT @Hp4155;":PAGE:CHAN:UVAR:DEF? 'VTH'"`

`ENTER @Hp4155;A$`

---

**:PAGE:CHANnels:UVAriable:DELete:ALL**

This command deletes all defined user variables.

This command does not have query form.

Syntax                    `:PAGE:CHANnels:UVAR:DELete:ALL`

Example                    `OUTPUT @Hp4155;":PAGE:CHAN:UVAR:DEL:ALL"`

---

**:PAGE:CHANnels:UVAriable:DELete[:NAME]**

This command deletes the specified user variable.

This command does not have query form.

Syntax                    `:PAGE:CHANnels:UVAriable:DELete[:NAME] name`

Parameter

Parameter	Type	Explanation
<i>name</i>	string	defined user variable name

Example                    `OUTPUT @Hp4155;":PAGE:CHAN:UVAR:DEL 'VD'"`

### **:PAGE:CHANnels:UVARiable[:MENU]**

This command changes the present display page to CHANNELS: USER VARIABLE DEFINITION page.

This command does not query form.

Syntax                    `:PAGE:CHANnels:UVARiable[:MENU]`

Example                    `OUTPUT @Hp4155;":PAGE:CHAN:UVAR"`

### **:PAGE:DISPlay:ANALysis:INTerpolate**

This command selects whether interpolation mode of marker is on or off.

At \*RST, this value is OFF.

Syntax                    `:PAGE:DISPlay:ANALysis:INTerpolate OFF|ON|0|1`

Parameter

<b>Parameter</b>	<b>Type</b>	<b>Explanation</b>
OFF or 0	boolean	interpolation is off
ON or 1	boolean	interpolation is on

Query response            `0|1 <newline><^END>`

**PAGE Subsystem**

Example                    `OUTPUT @Hp4155;":PAGE:DISP:ANAL:INT ON"`  
                           `OUTPUT @Hp4155;":PAGE:DISP:ANAL:INT?"`  
                           `ENTER @Hp4155;A`

**:PAGE:DISPlay:ANALysis:LINE(1|2):ASElect**

This command selects whether the Y axis is Y1 or Y2.

At \*RST, this value is Y1.

Syntax                    `:PAGE:DISPlay:ANALysis:LINE(1|2):ASElect Y1|Y2`

Parameter

Parameter	Type	Explanation
Y1	character	y axis is Y1
Y2	character	y axis is Y2

Query response           `Y1|Y2 <newline><^END>`

Example                    `OUTPUT @Hp4155;":PAGE:DISP:ANAL:LINE1:ASEL Y1"`  
                           `OUTPUT @Hp4155;":PAGE:DISP:ANAL:LINE1:ASEL?"`  
                           `ENTER @Hp4155;A$`

**:PAGE:DISPlay:ANALysis:LINE(1|2):GRADient**

This command sets the gradient value of LINE1 or LINE2.

If `LINE(1|2):MODE` is not `GRADient`, this parameter is ignored.



At \*RST, this value is undefined.

Syntax                   :PAGE:DISPlay:ANALysis:LINE(1|2):GRADient *gradient*

Parameter

Parameter	Type	Explanation
<i>gradient</i>	string	expression for gradient value of line

Query response

*gradient* <newline><^END>

*gradient* is string response data, but does not contain double quote characters at the beginning and end of the string.

Example

OUTPUT @Hp4155;":PAGE:DISP:ANAL:LINE1:GRAD '2.0'"

OUTPUT @Hp4155;":PAGE:DISP:ANAL:LINE1:GRAD?"

ENTER @Hp4155;A\$

## :PAGE:DISPlay:ANALysis:LINE(1|2):MODE

This command selects the line mode.

At \*RST, this value is **NORMAL**.

Syntax

:PAGE:DISPlay:ANALysis:LINE(1|2):MODE  
 NORMAL|GRADient|TANGent|REGReSSion|DISable

SCPI Commands  
**PAGE Subsystem**

Parameter

Parameter	Type	Explanation
NORMal	character	normal mode [use :POINT1 and :POINT2]
GRADient	character	gradient mode [use :POINT1 and :GRADient]
TANGent	character	tangent mode [use :TANGent]
REGReSSion	character	regression mode [use :POINT1 and :POINT2]
DISable	character	line is disabled

Query response

NORM|GRAD|TANG|REGR|DIS <newline><^END>

Example

```
OUTPUT @Hp4155;":PAGE:DISP:ANAL:LINE1:MODE GRAD"
OUTPUT @Hp4155;":PAGE:DISP:ANAL:LINE1:MODE?"
ENTER @Hp4155;A$
```

---

**:PAGE:DISPlay:ANALysis:LINE(1|2):POINT(1|2)  
:AFTer**

This command specifies the start position (**AFT**: *var\_name*, *expr*) to search for the point specified by (**POS**: *var\_name*, *expr*).

If **POINTs:MODE** is **XY** (not **OPLot**), this parameter is ignored.

At **\*RST**, this value is undefined.

Syntax

**:PAGE:DISPlay:ANALysis:LINE(1|2):POINT(1|2):AFTer** *var\_name*,  
*expr*

Parameter

Parameter	Type	Explanation
<i>var_name</i>	string	data variable name
<i>expr</i>	string	condition expression

Query response                    *var\_name, expr* <newline><^END>  
*var\_name* and *expr* are string response data, but do not contain double quote characters at the beginning and end.

Example

```
OUTPUT @Hp4155;":PAGE:DISP:ANAL:LINE1:POIN1:AFT 'DGM', 'MAX(DGM)'"
OUTPUT @Hp4155;":PAGE:DISP:ANAL:LINE1:POIN1:AFT?"
ENTER @Hp4155;A$
```

---

**:PAGE:DISPlay:ANALysis:LINE(1|2):POINT(1|2)  
:AFTer:STATe**

This command selects whether the start position of search is valid.  
If **AFTER** *var\_name, expr* is set, the **STATe** is automatically set to **ON**.  
If **POINTs:MODE** is **XY** (not **OPLot**), this parameter is ignored.  
At **\*RST**, this value is **OFF**.

Syntax                                :PAGE:DISPlay:ANALysis:LINE(1|2):POINT(1|2):AFTer:STATe  
OFF|ON|0|1

Parameter

Parameter	Type	Explanation
OFF or 0	boolean	search entire area for the point
ON or 1	boolean	search for point only after the specified start position

Query response                    0|1 <newline><^END>

SCPI Commands  
**PAGE Subsystem**

Example                    OUTPUT @Hp4155;":PAGE:DISP:ANAL:LINE1:POIN1:AFT:STAT ON"  
  
                          OUTPUT @Hp4155;":PAGE:DISP:ANAL:LINE1:POIN1:AFT:STAT?"  
                          ENTER @Hp4155;A

---

**:PAGE:DISPlay:ANALysis:LINE(1|2):POINt(1|2):MODE**

This command selects the point specification mode for line.  
If **LINE(1|2):MODE** is **TANGent**, then **POINt(1|2)** are not used.  
If **LINE(1|2):MODE** is **GRADient**, then **POINt2** is not used.  
At \*RST, this value is **XY**.

Syntax                    :PAGE:DISPlay:ANALysis:LINE(1|2):POINt(1|2):MODE XY|OPLot

Parameter

Parameter	Type	Explanation
XY	character	specify the X-Y coordinates directly
OPLot	character	specify by a condition expression

Query response           XY|OPL <newline><^END>

Example                   OUTPUT @Hp4155;":PAGE:DISP:ANAL:LINE1:POIN1:MODE XY"  
  
                          OUTPUT @Hp4155;":PAGE:DISP:ANAL:LINE1:POIN1:MODE?"  
                          ENTER @Hp4155;A\$

---

## :PAGE:DISPlay:ANALysis:LINE(1|2):POINT(1|2):POSition

This command specifies the desired point by using a condition expression.  
 If `POINT(1|2):MODE` is `XY` (not `OPLot`), this parameter is ignored.  
 At `*RST`, this value is undefined.

Syntax                    `:PAGE:DISPlay:ANALysis:LINE(1|2):POINT(1|2):POSition`  
                           *var\_name, expr*

Parameter

Parameter	Type	Explanation
<i>var_name</i>	string	data variable name
<i>expr</i>	string	condition expression

Query response

*var\_name, expr* <newline><^END>  
*var\_name* and *expr* are string response data, but do not contain double quote characters at the beginning and end.

Example

```
OUTPUT @Hp4155;":PAGE:DISP:ANAL:LINE1:POIN1:POS 'DGM', 'MAX(DGM)*0.01'"
OUTPUT @Hp4155;":PAGE:DISP:ANAL:LINE1:POIN1:POS?"
ENTER @Hp4155;A$
```

---

## :PAGE:DISPlay:ANALysis:LINE(1|2):POINT(1|2):X

This command specifies the X coordinate of the desired point.  
 If `POINT(1|2):MODE` is `OPLot` (not `XY`), this parameter is ignored.

SCPI Commands  
**PAGE Subsystem**

At \*RST, this value is undefined.

Syntax                   :PAGE:DISPlay:ANALysis:LINE(1|2):POINt(1|2):X *x\_expression*

Parameter

Parameter	Type	Explanation
<i>x_expression</i>	string	expression of the X coordinate point

Query response

*x\_value* <newline><^END>

*x\_value* is string response data, but do not contain double quote characters at beginning and end of the string.

Example

```
OUTPUT @Hp4155;":PAGE:DISP:ANAL:LINE1:POIN1:X '0.5'"
OUTPUT @Hp4155;":PAGE:DISP:ANAL:LINE1:POIN1:X?"
ENTER @Hp4155;A$
```

---

## :PAGE:DISPlay:ANALysis:LINE(1|2):POINt(1|2):Y

This command specifies the Y coordinate of the desired point.

If POINt(1|2):MODE is OPLot (not XY), this parameter is ignored.

At \*RST, this value is undefined.

Syntax                   :PAGE:DISPlay:ANALysis:LINE(1|2):POINt(1|2):Y *y\_expression*

Parameter

Parameter	Type	Explanation
<i>y_expression</i>	string	expression of the Y coordinate point

Query response            *y\_value* <newline><^END>  
*y\_value* is string response data, but does not contain double quote characters at the beginning and end of the string.

Example                    OUTPUT @Hp4155;":PAGE:DISP:ANAL:LINE1:POIN1:Y '0.1'"  
  
OUTPUT @Hp4155;":PAGE:DISP:ANAL:LINE1:POIN1:Y?"  
ENTER @Hp4155;A\$

## :PAGE:DISPlay:ANALysis:LINE(1|2):TANGent:AFter

This command specifies the start position (**TANG:AFT** *var\_name*, *expr*) to search for the point (**TANG:POS** *var\_name*, *expr*) at which to draw the tangent line.

If **LINE(1|2):MODE** is not **TANGent**, this parameter is ignored.

At \*RST, this value is undefined.

Syntax                    :PAGE:DISPlay:ANALysis:LINE(1|2):TANGent:AFter *var\_name*,  
*expr*

Parameter

Parameter	Type	Explanation
<i>var_name</i>	string	data variable name
<i>expr</i>	string	condition expression

Query response            *var\_name*, *expr* <newline><^END>  
*var\_name* and *expr* are string response data, but do not contain double quote characters at the beginning and end.

SCPI Commands  
**PAGE Subsystem**

Example

```
OUTPUT @Hp4155;":PAGE:DISP:ANAL:LINE1:TANG:AFT 'DGM', 'MAX(DGM)'"  
  
OUTPUT @Hp4155;":PAGE:DISP:ANAL:LINE1:TANG:AFT?"  
ENTER @Hp4155;A$
```

---

**:PAGE:DISPlay:ANALysis:LINE(1|2):TANGent:AFTer  
:STATe**

This command selects whether the start position of search is valid.

If **TANG:AFTER** *var\_name*, *expr* is set, the **STATe** is automatically set to **ON**.

If **LINE(1|2):MODE** is not **TANGent**, this parameter is ignored.

At \*RST, this value is **OFF**.

Syntax

```
:PAGE:DISPlay:ANALysis:LINE(1|2):TANGent:AFTer:STATe
```

Parameter

Parameter	Type	Explanation
OFF or 0	boolean	search entire area for the point
ON or 1	boolean	search for point only after the specified start position

Query response

```
O|1 <newline><^END>
```

Example

```
OUTPUT @Hp4155;":PAGE:DISP:ANAL:LINE1:TANG:AFT:STAT ON"  
  
OUTPUT @Hp4155;":PAGE:DISP:ANAL:LINE1:TANG:AFT:STAT?"  
ENTER @Hp4155;A
```



---

## :PAGE:DISPlay:ANALysis:LINE(1|2):TANGent :POSition

This command specifies the point at which to draw a tangent line. The point is specified by a condition expression.

If **LINE(1|2):MODE** is not **TANGent**, this parameter is ignored.

At \*RST, this value is undefined.

Syntax                    :**PAGE:DISPlay:ANALysis:LINE(1|2):TANGent:POSition** *var\_name*,  
*expr*

Parameter

Parameter	Type	Explanation
<i>var_name</i>	string	data variable name
<i>expr</i>	string	condition expression

Query response

*var\_name*, *expr* <newline><^END>

*var\_name* and *expr* are string response data, but do not contain double quote characters at the beginning and end.

Example

```
OUTPUT @Hp4155;":PAGE:DISP:ANAL:LINE1:TANG:POS 'DGM', 'MAX(DGM)*0.01'"
```

```
OUTPUT @Hp4155;":PAGE:DISP:ANAL:LINE1:TANG:POS?"
```

```
ENTER @Hp4155;A$
```

---

## :PAGE:DISPlay:ANALysis:MARKer:AFter

This command specifies the start position (**MARK:AFT** *var\_name*, *expr*) to search for the marker position specified by (**MARK:POS** *var\_name*, *expr*).

**PAGE Subsystem**

At \*RST, this value is undefined.

Syntax `:PAGE:DISPlay:ANALysis:MARKer:AFTer var_name, expr`

Parameter

Parameter	Type	Explanation
<i>var_name</i>	string	data variable name
<i>expr</i>	string	condition expression

Query response

`var_name, expr <newline><^END>`

*var\_name* and *expr* are string response data, but do not contain double quote characters at the beginning and end.

Example

```
OUTPUT @Hp4155;" :PAGE:DISP:ANAL:MARK:AFT 'DGM', 'MAX(DGM)'"
```

```
OUTPUT @Hp4155;" :PAGE:DISP:ANAL:MARK:AFT?"
```

```
ENTER @Hp4155;A$
```

**:PAGE:DISPlay:ANALysis:MARKer:AFTer:STATe**

This command selects whether the start position of search is valid.

If **MARK:AFTER** *var\_name*, *expr* is set, the **STATe** is automatically set to **ON**.

At \*RST, this value is **OFF**.

Syntax `:PAGE:DISPlay:ANALysis:MARKer:AFTer:STATe`

Parameter

Parameter	Type	Explanation
OFF or 0	boolean	search entire area for the point
ON or 1	boolean	search only after the specified start position

Query response            0|1 <newline><^END>

Example                    OUTPUT @Hp4155;":PAGE:DISP:ANAL:MARK:AFT:STAT ON"  
  
                          OUTPUT @Hp4155;":PAGE:DISP:ANAL:MARK:AFT:STAT?"  
                          ENTER @Hp4155;A

---

### **:PAGE:DISPlay:ANALysis:MARKer:DISable**

This command clears the marker settings.

This command does not have query form.

Syntax                    :PAGE:DISPlay:ANALysis:MARKer:DISable

Example                    OUTPUT @Hp4155;":PAGE:DISP:ANAL:MARK:DIS

---

### **:PAGE:DISPlay:ANALysis:MARKer:POSition**

This command specifies the marker's position by using a condition expression.

At \*RST, this value is undefined.

Syntax                    :PAGE:DISPlay:ANALysis:MARKer:POSition *var\_name*, *expr*

SCPI Commands  
**PAGE Subsystem**

Parameter

Parameter	Type	Explanation
<i>var_name</i>	string	data variable name
<i>expr</i>	string	condition expression

Query response

*var\_name*, *expr* <newline><^END>

*var\_name* and *expr* are string response data, but do not contain double quote characters at the beginning and end.

Example

```
OUTPUT @Hp4155;":PAGE:DISP:ANAL:MARK:POS 'DGM', 'MAX(DGM)*0.01'"
```

```
OUTPUT @Hp4155;":PAGE:DISP:ANAL:MARK:POS?"
```

```
ENTER @Hp4155;A$
```

---

## :PAGE:DISPlay:ANALysis[:MENU]

This command changes the present display page to DISPLAY: ANALYSIS SETUP page.

This command does not have query form.

Syntax

```
:PAGE:DISPlay:ANALysis[:MENU]
```

Example

```
OUTPUT @Hp4155;":PAGE:DISP:ANAL"
```

---

## **:PAGE:DISPlay[:SETup]:DVARiables:DELeTe:ALL**

This command deletes all names that are displayed in the DATA VARIABLES fields of the DISPLAY: DISPLAY SETUP page. This is effective for both LIST and GRAPHICS display pages.

This command does not have query form.

Syntax                                **:PAGE:DISPlay [ :SETup ] :DVARiables:DELeTe:ALL**

Example                                **OUTPUT @Hp4155; ":PAGE:DISP:DVAR:DEL:ALL"**

---

## **:PAGE:DISPlay[:SETup]:DVARiables:DELeTe[:NAME]**

This command deletes the specified variable name from the DATA VARIABLES field of the DISPLAY: DISPLAY SETUP page.

This command does not have query form.

Syntax                                **:PAGE:DISPlay [ :SETup ] :DVARiables:DELeTe [ :NAME ] *var\_name***

Parameter

<b>Parameter</b>	<b>Type</b>	<b>Explanation</b>
<i>var_name</i>	string	data variable name that appears in the DATA VARIABLES field of DISPLAY: DISPLAY SETUP page.

SCPI Commands  
**PAGE Subsystem**

Example                    `OUTPUT @Hp4155;":PAGE:DISP:DVAR:DEL 'VD'"`

---

### **:PAGE:DISPlay[:SETup]:DVARiables[:SElect]**

This command selects the *additional* data variables for the graph or list. The coordinate values of these variables will be displayed according to the position of the marker.

If the specified variable name already exists, this command overwrites the old data with the newly defined data.

A maximum of two data variables can be used. If this limit is exceeded, **Cannot define more than 2 displayed data vars. error (-184)** is generated.

On the DISPLAY:DISPLAY SETUP page, this command fills the DATA VARIABLE blank fields from upper field to lower.

At \*RST, no variable is selected.

Syntax                    `:PAGE:DISPlay[:SETup]:DVARiables[:SElect]: var_name`  
                          `{,var_name}`

Parameter

Parameter	Type	Explanation
<i>var_name</i>	string	data variable name

Query response

`var_name {,var_name}<newline><^END>`

Response is a list of data variables separated by commas, and is string response data, but does not contain double quote characters at the beginning and end of the string.

Example                    `OUTPUT @Hp4155;":PAGE:DISP:DVAR 'VD', 'VG'"`  
                           `OUTPUT @Hp4155;":PAGE:DISP:DVAR?"`  
                           `ENTER @Hp4155;A$`

### **:PAGE:DISPlay[:SETup]:GRAPhics:GRID**

This command selects whether the grid of graph is on or off.  
 At \*RST, this value is ON.

Syntax                    `:PAGE:DISPlay[:SETup]:GRAPhics:GRID OFF|ON|0|1`

Parameter

Parameter	Type	Explanation
OFF or 0	boolean	grid is off
ON or 1	boolean	grid is on

Query response           `0|1 <newline><^END>`

Example                    `OUTPUT @Hp4155;":PAGE:DISP:GRAP:GRID ON"`  
                           `OUTPUT @Hp4155;":PAGE:DISP:GRAP:GRID?"`  
                           `ENTER @Hp4155;A`

### **:PAGE:DISPlay[:SETup]:GRAPhics:LPARam**

This command selects whether the line parameters (gradients and intercepts of lines) will be displayed on the graph.

SCPI Commands  
**PAGE Subsystem**

At \*RST, this value is ON.

Syntax                   :PAGE:DISPLAY[:SETup]:GRAPHics:LPARam OFF|ON|0|1

Parameter

Parameter	Type	Explanation
OFF or 0	boolean	line parameters are not displayed
ON or 1	boolean	line parameters are displayed

Query response        0|1 <newline><^END>

Example                OUTPUT @Hp4155;":PAGE:DISP:GRAP:LPAR ON"  
  
                      OUTPUT @Hp4155;":PAGE:DISP:GRAP:LPAR?"  
                      ENTER @Hp4155;A

---

### :PAGE:DISPlay[:SETup]:GRAPHics:X|:Y1|:Y2:DELeTe

This command deletes the assignment of the X, Y1, or Y2 axis.

This command does not have query form.

Syntax                   :PAGE:DISPlay[:SETup]:GRAPHics:X|:Y1|:Y2:DELeTe

Example                OUTPUT @Hp4155;":PAGE:DISP:GRAP:X:DEL"

---

### :PAGE:DISPlay[:SETup]:GRAPHics:X|:Y1|:Y2:MAX

This command sets the maximum value of X, Y1, or Y2 axis.



At \*RST, this value is:

**AXIS variable name**

X 1 V  
 Y1 100 mA  
 Y2 0

Syntax :PAGE:DISPlay[:SETup]:GRAPhics:X|:Y1|:Y2:MAX *maximum*

Parameter

Parameter	Type	Explanation
<i>maximum</i>	numeric	maximum value of X, Y1, or Y2 axis

Query response

*maximum* <newline><^END>

*maximum* is NR3 response data type.

Example

OUTPUT @Hp4155;":PAGE:DISP:GRAP:X:MAX 10"

OUTPUT @Hp4155;":PAGE:DISP:GRAP:X:MAX?"

ENTER @Hp4155;A

**:PAGE:DISPlay[:SETup]:GRAPhics:X|:Y1|:Y2:MIN**

This command sets the minimum value of X, Y1, or Y2 axis.

At \*RST, this value is:

**AXIS variable name**

X 0 V  
 Y1 0 A  
 Y2 0

**PAGE Subsystem**

Syntax                   :PAGE:DISPlay[:SETup]:GRAPhics:X|:Y1|:Y2:MIN *minimum*

Parameter

Parameter	Type	Explanation
<i>minimum</i>	numeric	minimum value of X, Y1, or Y2 axis

Query response

*minimum* <newline><^END>

*minimum* is NR3 response data type.

Example

OUTPUT @Hp4155;" :PAGE:DISP:GRAP:X:MIN 0"

OUTPUT @Hp4155;" :PAGE:DISP:GRAP:X:MIN?"

ENTER @Hp4155;A

**:PAGE:DISPlay[:SETup]:GRAPhics:X|:Y1|:Y2:NAME**

This command selects the variable name of X, Y1, or Y2 axis.

At \*RST, this value is:

**AXIS variable name**

X	V3
Y1	I3
Y2	not defined

Syntax

:PAGE:DISPlay[:SETup]:GRAPhics:X|:Y1|:Y2:NAME *var\_name*

Parameter

Parameter	Type	Explanation
<i>var_name</i>	string	data variable name

Query response            *var\_name* <newline><^END>  
*var\_name* is string response data, but does not contain double quote characters at beginning and end of the string.

Example                    OUTPUT @Hp4155;":PAGE:DISP:GRAP:X:NAME 'VD'"  
  
OUTPUT @Hp4155;":PAGE:DISP:GRAP:X:NAME?"  
ENTER @Hp4155;A\$

## :PAGE:DISPlay[:SETup]:GRAPhics:X|:Y1|:Y2:SCALe

This command selects whether the scale of X, Y1, or Y2 axis is LINear or LOGarithmic.

At \*RST, this value is LINear for X and Y1, and not defined for Y2.

Syntax                    :PAGE:DISPlay[ :SETup ]:GRAPhics:X|:Y1|:Y2:SCALe  
LINear|LOGarithmic

Parameter

Parameter	Type	Explanation
LINear	character	linear scale
LOGarithmic	character	logarithmic scale

Query response            LIN|LOG <newline><^END>

Example                    OUTPUT @Hp4155;":PAGE:DISP:GRAP:X:SCAL LIN"  
  
OUTPUT @Hp4155;":PAGE:DISP:GRAP:X:SCAL?"  
ENTER @Hp4155;A\$

---

## **:PAGE:DISPlay[:SETup]:LIST:DELeTe:ALL**

This command deletes all the variable names from the LIST display. This does not delete the DATA VARIABLES fields, only the variable names in columns of LIST table.

This command does not have query form.

Syntax                    **:PAGE:DISPlay [ :SETup ] :LIST:DELeTe:ALL**

Example                    **OUTPUT @Hp4155;":PAGE:DISP:LIST:DEL:ALL"**

---

## **:PAGE:DISPlay[:SETup]:LIST:DELeTe[:NAME]**

This command deletes the specified variable name from the LIST display.

This command does not have query form.

Syntax                    **:PAGE:DISPlay [ :SETup ] :LIST:DELeTe [ :NAME ] *var\_name***

Parameter

<b>Parameter</b>	<b>Type</b>	<b>Explanation</b>
<i>var_name</i>	string	data variable name that appears in LIST table.

Example                    **OUTPUT @Hp4155;":PAGE:DISP:LIST:DEL 'VD' "**

---

## :PAGE:DISPlay[:SETup]:LIST[:SElect]

This command selects the variable names for LIST display.

You can display a maximum of eight variables in the list. If this limit is exceeded, **Cannot define more than 8 data vars in lists. error (-183)** is generated.

On the DISPLAY:DISPLAY SETUP page, this command fills the blank LIST fields in the specified order.

At \*RST, no variable is selected.

Syntax                                   :PAGE:DISPlay [ :SETup ] :LIST [ :SElect ] : *var\_name* { ,*var\_name* }

Parameter

Parameter	Type	Explanation
<i>var_name</i>	string	data variable name

Query response

*var\_name* <newline><^END>

*var\_name* is a list of variable names separated by commas, and is string response data, but does not contain double quote characters at the beginning and end of the string.

Example

```
OUTPUT @Hp4155;":PAGE:DISP:LIST 'VD','VG'"
OUTPUT @Hp4155;":PAGE:DISP:LIST?"
ENTER @Hp4155;A$
```

---

## :PAGE:DISPlay[:SETup][:MENU]

This command changes the present display page to DISPLAY: DISPLAY SETUP.

SCPI Commands  
**PAGE Subsystem**

This command does not have query form.

Syntax                   :PAGE:DISPlay[:SETup][:MENU]

Example                 OUTPUT @Hp4155;":PAGE:DISP"

---

### :PAGE:DISPlay[:SETup]:MODE

This command selects the display mode.

At \*RST, this value is GRAPHics.

Syntax                   :PAGE:DISPlay[:SETup]:MODE GRAPHics|LIST

Parameter

Parameter	Type	Explanation
GRAPHics	character	graphics display mode
LIST	character	list display mode

Query response         GRAP|LIST <newline><^END>

Example                 OUTPUT @Hp4155;":PAGE:DISP:MODE GRAP"

OUTPUT @Hp4155;":PAGE:DISP:MODE?"  
ENTER @Hp4155;A\$

---

## :PAGE:GLIST[:GRAPHics]:AANalysis

This command redisplay the marker, cursors, and lines at the same positions as after auto-analysis was performed when the measurement finished. Auto-analysis is determined by DISPLAY: ANALYSIS SETUP, which corresponds to the :PAGE:DISPLAY:ANALysis subsystem.

This command does not have query form.

Syntax                   :PAGE:GLIST[:GRAPHics]:AANalysis

Example                 OUTPUT @Hp4155;":PAGE:GLIS:AAN"

---

## :PAGE:GLIST[:GRAPHics]:ASElect

This command selects whether the Y axis is Y1 or Y2.

At \*RST, this value is Y1.

Syntax                   :PAGE:GLIST[:GRAPHics]:ASElect Y1|Y2

Parameter

Parameter	Type	Explanation
Y1	character	y axis is Y1
Y2	character	y axis is Y2

Query response         Y1|Y2 <newline><^END>

**PAGE Subsystem**

Example                    OUTPUT @Hp4155;":PAGE:GLIS:ASEL Y1"  
  
                          OUTPUT @Hp4155;":PAGE:GLIS:ASEL?"  
                          ENTER @Hp4155;A\$

**:PAGE:GLIST[:GRAPhics]:CURSor:DIRect:X|:Y1|:Y2**

This command moves the cursor to the point that has the specified X, Y1, or Y2 value.

For the query response, the returned data is the X value of the present cursor position.

Variable name must be assigned to the specified axis by using :PAGE:DISP:GRAP:X|:Y1|:Y2:NAME command.

At \*RST, this value is undefined.

Syntax                    :PAGE:GLIST[:GRAPhics]:CURSor:DIRect:X|:Y1|:Y2 *value*

Parameter

Parameter	Type	Explanation
<i>value</i>	numeric	x, y1, or y2 coordinate value

Query response           *value* <newline><^END>

*value* is NR3 response data type.

Example                    OUTPUT @Hp4155;":PAGE:GLIS:CURS:DIR:X 0.5"  
  
                          OUTPUT @Hp4155;":PAGE:GLIS:CURS:DIR:X?"  
                          ENTER @Hp4155;A



---

## **:PAGE:GLIST[:GRAPHics]:CURSor[:STATe]**

This command sets the state of cursor.

At \*RST, this value is **OFF**.

Syntax                    **:PAGE:GLIST[:GRAPHics]:CURSor[:STATe]OFF|SHORT|LONG**

Parameter

<b>Parameter</b>	<b>Type</b>	<b>Explanation</b>
OFF	character	cursor is off
SHORT	character	short cursor is on
LONG	character	long cursor is on

Query response            **OFF|SHORT|LONG <newline><^END>**

Example                    **OUTPUT @Hp4155;":PAGE:GLIS:CURS LONG"**  
**OUTPUT @Hp4155;":PAGE:GLIS:CURS?"**  
**ENTER @Hp4155;A\$**

---

## **:PAGE:GLIST[:GRAPHics]:DISPlay:DVARiables**

This command selects whether the variables specified in the DATA VARIABLES fields of the DISPLAY: DISPLAY SETUP will be displayed on the graph or list.

At \*RST, this value is **OFF**.

Syntax                    **:PAGE:GLIST[:GRAPHics]:DISPlay:DVARiables OFF|ON|0|1**

**PAGE Subsystem**

Parameter

Parameter	Type	Explanation
OFF or 0	boolean	variable list is off
ON or 1	boolean	variable list is on

Query response

0|1 &lt;newline&gt;&lt;^END&gt;

Example

OUTPUT @Hp4155;":PAGE:GLIS:DISP:DVAR ON"

OUTPUT @Hp4155;":PAGE:GLIS:DISP:DVAR?"

ENTER @Hp4155;A

---

**:PAGE:GLIST[:GRAPHics]:DISPlay:OVERlay:STOVerlay**

This command forces the scale of the present measurement data to that of the overlay plane.

This command does not have query form.

Syntax

:PAGE:GLIST[:GRAPHics]:DISPlay:OVERlay:STOVerlay

Example

OUTPUT @Hp4155;":PAGE:GLIS:DISP:OVER:STOV"

---

**:PAGE:GLIST[:GRAPHics]:DISPlay:OVERlay[:PLANE]**

This command overlays data in the selected internal memory onto the plotting area.

At \*RST, this value is OFF.

Syntax                    `:PAGE:GLISt[:GRAPhics]:DISPlay:OVERlay[:PLANe]  
memory_no|OFF|O`

Parameter

Parameter	Type	Explanation
<i>memory_no</i>	numeric	1 to 4
OFF or 0	boolean	overlay plane is off

Query response

`memory_no <newline><^END>`  
*memory\_no* is NR1 response data.

Example

OUTPUT @Hp4155;":PAGE:GLIS:DISP:OVER 1"  
  
OUTPUT @Hp4155;":PAGE:GLIS:DISP:OVER?"  
ENTER @Hp4155;A

## **:PAGE:GLISt[:GRAPhics]:DISPlay:OVERlay:SINFo**

This command sets the “show overlay information” mode to on or off.  
At \*RST, this value is OFF.

Syntax                    `:PAGE:GLISt[:GRAPhics]:DISPlay:OVERlay:SINFo OFF|ON|O|1`

Parameter

Parameter	Type	Explanation
OFF or 0	boolean	“show overlay information” mode is off
ON or 1	boolean	“show overlay information” mode is on

Query response

`O|1 <newline><^END>`

**PAGE Subsystem**

Example                    OUTPUT @Hp4155;":PAGE:GLIS:DISP:OVER:SINF ON"  
                           OUTPUT @Hp4155;":PAGE:GLIS:DISP:OVER:SINF?"  
                           ENTER @Hp4155;A

**:PAGE:GLIST[:GRAPHics]:DISPlay:GRID**

This command selects whether the grid of graph axis is on or off.

At \*RST, this value is ON.

Syntax                    :PAGE:GLIST[:GRAPHics]:DISPlay:GRID OFF|ON|0|1

Parameter

Parameter	Type	Explanation
OFF or 0	boolean	grid is off
ON or 1	boolean	grid is on

Query response            0|1 <newline><^END>

Example                    OUTPUT @Hp4155;":PAGE:GLIS:DISP:GRID ON"  
                           OUTPUT @Hp4155;":PAGE:GLIS:DISP:GRID?"  
                           ENTER @Hp4155;A

**:PAGE:GLIST[:GRAPHics]:DISPlay:LPAram**

This command selects whether the line parameters (gradient and intercepts of lines) are displayed on the graph.

At \*RST, this value is ON.

Syntax                   :PAGE:GLISt[:GRAPhics]:DISPlay:LPARam OFF|ON|0|1

Parameter

Parameter	Type	Explanation
OFF or 0	boolean	line parameters are not displayed
ON or 1	boolean	line parameters are displayed

Query response           0|1 <newline><^END>

Example

```
OUTPUT @Hp4155;":PAGE:GLIS:DISP:LPAR ON"
OUTPUT @Hp4155;":PAGE:GLIS:DISP:LPAR?"
ENTER @Hp4155;A
```

## :PAGE:GLISt[:GRAPhics]:INTerpolate

This command selects whether interpolation mode of marker is on or off.

At \*RST, this value is OFF.

Syntax                   :PAGE:GLISt[:GRAPhics]:INTerpolate OFF|ON|0|1

Parameter

Parameter	Type	Explanation
OFF or 0	boolean	interpolation is off
ON or 1	boolean	interpolation is on

Query response           0|1 <newline><^END>

**PAGE Subsystem**

Example                    `OUTPUT @Hp4155;":PAGE:GLIS:INT ON"`

`OUTPUT @Hp4155;":PAGE:GLIS:INT?"`  
                          `ENTER @Hp4155;A`

---

### **:PAGE:GLIS[:GRAPhics]:LINE:CTMarker**

This command moves the cursor to the marker's position.

This command does not have query form.

Syntax                    `:PAGE:GLIS[:GRAPhics]:LINE:CTMarker`

Example                    `OUTPUT @Hp4155;":PAGE:GLIS:LINE:CTM"`

---

### **:PAGE:GLIS[:GRAPhics]:LINE:GRADient**

This command sets the gradient value of line.

If `LINE:LSElect` is `NONE`, this command is ignored.

At `*RST`, this value is undefined.

Syntax                    `:PAGE:GLIS[:GRAPhics]:LINE:GRADient gradient`

Parameter

<b>Parameter</b>	<b>Type</b>	<b>Explanation</b>
<i>gradient</i>	numeric	gradient value of line

Query response            *gradient* <newline><^END>

*gradient* is NR3 response data type.

Example                    OUTPUT @Hp4155;":PAGE:GLIS:LINE:GRAD 1.5"

OUTPUT @Hp4155;":PAGE:GLIS:LINE:GRAD?"  
 ENTER @Hp4155;A

## :PAGE:GLIS[:GRAPHics]:LINE:LSElect

This command selects the line to operate on.

At \*RST, this value is NONE.

Syntax                    :PAGE:GLIS[:GRAPHics]:LINE:LSElect  
 LINE1|LINE2|NONE|*line\_number*|MINimum|MAXimum

Parameter

Parameter	Type	Explanation
LINE1	character	line 1 is selected
LINE2	character	line 2 is selected
NONE	character	no lines are selected
<i>line_number</i>	numeric	1 or 2

Query response            *line\_number* <newline><^END>

Example                    OUTPUT @Hp4155;":PAGE:GLIS:LINE:LSEL 1"

OUTPUT @Hp4155;":PAGE:GLIS:LINE:LSEL?"  
 ENTER @Hp4155;A

---

## :PAGE:GLIST[:GRAPHics]:LINE:MODE

This command selects the line mode.

Although this value is not defined at \*RST, if you select the line to operate on by using :PAGE:GLIST[:GRAPHics]:LINE:LSElect, this value is set to **NORM**.

Syntax

```
:PAGE:GLIST[:GRAPHics]:LINE:MODE  
NORMal|GRADient|TANGent|REGReSSion
```

Parameter

Parameter	Type	Explanation
NORMal	character	normal mode
GRADient	character	gradient mode
TANGent	character	tangent mode
REGReSSion	character	regression mode

Query response

```
NORM|GRAD|TANG|REGR <newline><^END>
```

Example

```
OUTPUT @Hp4155;":PAGE:GLIS:LINE:MODE GRAD"  
  
OUTPUT @Hp4155;":PAGE:GLIS:LINE:MODE?"  
ENTER @Hp4155;A$
```

---

## :PAGE:GLIST[:GRAPHics]:LINE:SCURsor

This command toggles which cursor you want to operate on.

This command does not have query form.



Syntax                   :PAGE:GLISt[:GRAPhics]:LINE:SCURsor

Example                  OUTPUT @Hp4155;":PAGE:GLIS:LINE:SCUR"

### :PAGE:GLISt[:GRAPhics]:LINE[:STATe]

This command selects the state of line.

At \*RST, this value is not defined.

Syntax                   :PAGE:GLISt[:GRAPhics]:LINE[:STATe]OFF|ON

Parameter

Parameter	Type	Explanation
OFF	character	line is not displayed
ON	character	line is displayed, and can be operated on

Query response         OFF|ON <newline><^END>

Example                  OUTPUT @Hp4155;":PAGE:GLIS:LINE ON"

OUTPUT @Hp4155;":PAGE:GLIS:LINE?"  
 ENTER @Hp4155;A\$

### :PAGE:GLISt[:GRAPhics]:MARKer:DIRect:X|:Y1|:Y2

This command moves the marker to the point that has the specified X, Y1, or Y2 value.

**PAGE Subsystem**

For the query response, the returned data is the X, Y1, or Y2 value of the present marker position.

Variable name must be assigned to the specified axis by using `:PAGE:DISP:GRAP:X|:Y1|:Y2:NAME` command.

At \*RST, this value is undefined.

Syntax

```
:PAGE:GLISt[:GRAPhics]:MARKer:DIRect:X|:Y1|:Y2
value|MINimum|MAXimum
```

Parameter

Parameter	Type	Explanation
<i>value</i>	numeric	x, y1, or y2 coordinate value

Query response

```
value <newline><^END>
```

*value* is NR3 response data type.

Example

```
OUTPUT @Hp4155;":PAGE:GLIS:MARK:DIR:X 0.5"
```

```
OUTPUT @Hp4155;":PAGE:GLIS:MARK:DIR:X?"
ENTER @Hp4155;A
```

---

**:PAGE:GLIS[:GRAPhics]:MARKer:LIMit**

This command moves the marker to the minimum or maximum Y axis point of curve.

The search direction is from present to last measurement point, then from first to present measurement point.

This command does not have query form.

Syntax                   :PAGE:GLISt[:GRAPhics]:MARKer:LIMit

Example                 OUTPUT @Hp4155;":PAGE:GLIS:MARK:LIM"

### :PAGE:GLISt[:GRAPhics]:MARKer:SKIP

This command skips the marker to the next measurement curve that was added by VAR2 variable or APPEND data.

This command does not have query form.

Syntax                   :PAGE:GLISt[:GRAPhics]:MARKer:SKIP

Example                 OUTPUT @Hp4155;":PAGE:GLIS:MARK:SKIP"

### :PAGE:GLISt[:GRAPhics]:MARKer[:STATe]

This command selects whether the marker is on or off.

At \*RST, this value is OFF.

Syntax                   :PAGE:GLISt[:GRAPhics]:MARKer[:STATe]OFF|ON|0|1

Parameter

Parameter	Type	Explanation
OFF or 0	boolean	marker is off
ON or 1	boolean	marker is on

SCPI Commands

**PAGE Subsystem**

Query response            O|1 <newline><^END>

Example                    OUTPUT @Hp4155;":PAGE:GLIS:MARK ON"

                          OUTPUT @Hp4155;":PAGE:GLIS:MARK?"

                          ENTER @Hp4155;A

---

**:PAGE:GLIS[:GRAPhics][:MENU]**

This command changes the present display page to GRAPH/LIST: GRAPHICS.  
This command does not have query form.

Syntax                    :PAGE:GLIS[:GRAPhics][:MENU]

Example                    OUTPUT @Hp4155;":PAGE:GLIS"

---

**:PAGE:GLIS[:GRAPhics]:SCALing:AUTO**

This command redraws the present graphic display with appropriate scale to plot the data in the plotting area.  
This command does not have query form.

Syntax                    :PAGE:GLIS[:GRAPhics]:SCALing:AUTO ONCE

Example                    `OUTPUT @Hp4155;":PAGE:GLIS:SCAL:AUTO ONCE"`

---

### **:PAGE:GLIS[:GRAPHics]:SCALing:CANCel**

This command redraws the plotting area with the “original settings”.

“Original settings” means the most recent settings of the DISPLAY: DISPLAY SETUP page or `RE-SETUP GRAPH` secondary softkey.

This command does not have query form.

Syntax                    `:PAGE:GLIS[:GRAPHics]:SCALing:CANCel`

Example                    `OUTPUT @Hp4155;":PAGE:GLIS:SCAL:CANCel"`

---

### **:PAGE:GLIS[:GRAPHics]:SCALing:CENTer**

This command redraws the graphic display so that it is centered around the present cursor position.

This command does not have query form.

Syntax                    `:PAGE:GLIS[:GRAPHics]:SCALing:CENTer`

SCPI Commands  
**PAGE Subsystem**

Example                    `OUTPUT @Hp4155;":PAGE:GLIS:SCAL:CENTer"`

---

### **:PAGE:GLIS[:GRAPhics]:SCALing:CTMarker**

This command moves the cursor to the marker's position.

This command does not have query form.

Syntax                    `:PAGE:GLIS[:GRAPhics]:SCALing:CTMarker`

Example                    `OUTPUT @Hp4155;":PAGE:GLIS:SCAL:CTM"`

---

### **:PAGE:GLIS[:GRAPhics]:SCALing:ZOOM**

This command zooms the graphic display around the present cursor position.

This command does not have query form.

Syntax                    `:PAGE:GLIS[:GRAPhics]:SCALing:ZOOM IN|OUT`

Parameter

<b>Parameter</b>	<b>Type</b>	<b>Explanation</b>
IN	character	zoom in
OUT	character	zoom out

Example                    `OUTPUT @Hp4155;":PAGE:GLIS:SCAL:ZOOM IN"`

## **:PAGE:GLIS:LIST:ASElect**

This command selects whether the Y axis of GRAPHICS page is Y1 or Y2 and changes the setting by :PAGE:GLIS[:GRAPHics]:ASElect.

You use this command when you would like to assign data variables, which uses line parameters of graphics, on list.

At \*RST, this value is Y1.

Syntax                    `:PAGE:GLIS:LIST:ASElect Y1|Y2`

Parameter

Parameter	Type	Explanation
Y1	character	y axis is Y1
Y2	character	y axis is Y2

Query response            `Y1|Y2 <newline><^END>`

Example                    `OUTPUT @Hp4155;":PAGE:GLIS:LIST:ASEL Y1"`

```
OUTPUT @Hp4155;":PAGE:GLIS:LIST:ASEL?"
ENTER @Hp4155;A$
```

## **:PAGE:GLIS:LIST:MARKer:DIRect**

This command moves the marker to the variable value that is closest to the specified value.

**PAGE Subsystem**

For the query response, the returned data is the value at the present marker position.

At \*RST, this value is undefined.

Syntax

```
:PAGE:GLIST:LIST:MARKer:DIRect var_name|INDex,  
value|MINimum|MAXimum
```

Parameter

Parameter	Type	Explanation
<i>var_name</i>	string	name of variable that is in LIST column
INDex	character	index field
<i>value</i>	numeric	variable value or index number

Syntax of the query is as follows:

```
:PAGE:GLIST:LIST:MARKer:DIRect var_name|INDex  
{ , MINimum|MAXimum }
```

Query response

```
value <newline><^END>
```

*value* is NR3 response data.

Example

```
OUTPUT @Hp4155;":PAGE:GLIST:LIST:MARK:DIR 'VD', 0.5"
```

```
OUTPUT @Hp4155;":PAGE:GLIST:LIST:MARK:DIR 'VD', MAX"
```

```
OUTPUT @Hp4155;":PAGE:GLIST:LIST:MARK:DIR?" 'VD'"  
ENTER @Hp4155;B
```

```
OUTPUT @Hp4155;":PAGE:GLIST:LIST:MARK:DIR?" 'VD', MAX "  
ENTER @Hp4155;B
```



---

## **:PAGE:GLIST:LIST:MARKer:SKIP**

This command skips the marker to the next VAR2 value or to the next appended data.

This command does not have query form.

Syntax                               :PAGE:GLIST:LIST:MARKer:SKIP

Example                               OUTPUT @Hp4155;":PAGE:GLIST:LIST:MARK:SKIP"

---

## **:PAGE:GLIST:LIST:MARKer[:STATE]**

This command selects whether the marker is on or off.

At \*RST, this value is OFF.

Syntax                               :PAGE:GLIST:LIST:MARKer[:STATE]OFF|ON|0|1

Parameter

Parameter	Type	Explanation
OFF or 0	boolean	marker is off
ON or 1	boolean	marker is on

Query response                       0|1 <newline><^END>

Example                               OUTPUT @Hp4155;":PAGE:GLIST:LIST:MARK ON"

OUTPUT @Hp4155;":PAGE:GLIST:LIST:MARK?"  
ENTER @Hp4155;A

---

## :PAGE:GLIST:LIST[:MENU]

This command changes the present display page to GRAPH/LIST: LIST page.

This command does not have query form.

Syntax                   :PAGE:GLIST:LIST[:MENU]

Example                   OUTPUT @Hp4155;":PAGE:GLIS:LIST"

---

## :PAGE:KSWEEP:CURSOR:X

This command positions the cursor at the specified X coordinate. This command does not affect the Y coordinate of the cursor.

At \*RST, the cursor is located at the center of the graph.

Syntax                   :PAGE:KSWEEP:CURSOR:X *x\_position* | MINimum | MAXimum

Parameter

Parameter	Type	Explanation
<i>x_position</i>	numeric	desired X coordinate of cursor

Query response           *x\_position* <newline><^END>

*x\_position* is NR3 response data.

Example                   OUTPUT @Hp4155;":PAGE:KSW:CURS:X 1.35"

OUTPUT @Hp4155;":PAGE:KSW:CURS:X MAX"

OUTPUT @Hp4155;":PAGE:KSW:CURS:X?"

```
ENTER @Hp4155;A

OUTPUT @Hp4155;":PAGE:KSW:CURS:X? MIN"
ENTER @Hp4155;A
```

---

## :PAGE:KSweep:CURSor:Y

This command positions the cursor at the specified Y coordinate. This command does not affect the X coordinate of the cursor.

At \*RST, the cursor is located at the center of the graph.

Syntax                   :PAGE:KSweep:CURSor:Y *y\_position* | MINimum | MAXimum

Parameter

Parameter	Type	Explanation
<i>y_position</i>	numeric	desired Y coordinate of cursor

Query response

*y\_position* <newline><^END>

*y\_position* is NR3 response data type.

Example

```
OUTPUT @Hp4155;":PAGE:KSW:CURS:Y 1.35"

OUTPUT @Hp4155;":PAGE:KSW:CURS:Y MAX"

OUTPUT @Hp4155;":PAGE:KSW:CURS:Y?"
ENTER @Hp4155;A

OUTPUT @Hp4155;":PAGE:KSW:CURS:Y? MIN"
ENTER @Hp4155;A
```

---

## **:PAGE:KSWEEP:DISPLAY:DIRection:X**

This command sets the display direction of the X axis for knob sweep.  
At \*RST, this value is **NORMal**.

Syntax                    **:PAGE:KSWEEP:DISPLAY:DIRection:X NORMal|REVerse**

Parameter

<b>Parameter</b>	<b>Type</b>	<b>Explanation</b>
NORMal	character	Leftmost point on X axis is minimum value.
REVerse	character	Rightmost point on X axis is minimum value.

Query response            **NORM|REV <newline><^END>**

Example                    **OUTPUT @Hp4155;":PAGE:KSW:DISP:DIR:X NORM"**  
  
**OUTPUT @Hp4155;":PAGE:KSW:DISP:DIR:X?"**  
**ENTER @Hp4155;A\$**

---

## **:PAGE:KSWEEP:DISPLAY:DIRection:Y**

This command sets the display direction of the Y axis for knob sweep.  
At \*RST, this value is **NORMal**.

Syntax                    **:PAGE:KSWEEP:DISPLAY:DIRection:Y NORMal|REVerse**

Parameter

Parameter	Type	Explanation
NORMal	character	Lowermost point on Y axis is minimum value.
REVerse	character	Uppermost point on Y axis is minimum value.

Query response

NORM|REV <newline><^END>

Example

OUTPUT @Hp4155;":PAGE:KSW:DISP:DIR:Y NORM"

OUTPUT @Hp4155;":PAGE:KSW:DISP:DIR:Y?"

ENTER @Hp4155;A\$

---

## :PAGE:KSW:DISP:GRID

This command selects whether the grid of graph is on or off for knob sweep. At \*RST, this value is ON.

Syntax

:PAGE:KSW:DISP:GRID OFF|ON|0|1

Parameter

Parameter	Type	Explanation
OFF or 0	boolean	grid is off
ON or 1	boolean	grid is on

Query response

0|1 <newline><^END>

Example

OUTPUT @Hp4155;":PAGE:KSW:DISP:GRID ON"

OUTPUT @Hp4155;":PAGE:KSW:DISP:GRID?"

ENTER @Hp4155;A

SCPI Commands  
**PAGE Subsystem**

---

## :PAGE:KSWEEP:DISPLAY:REGION:X

This command sets the display region of X axis for knob sweep.

At \*RST, this value is POSitive.

Syntax                   :PAGE:KSWEEP:DISPLAY:REGION:X POSitive|NEGative|BIPolar

Parameter

Parameter	Type	Explanation
POSitive	character	display positive X region
NEGative	character	display negative X region
BIPolar	character	display positive and negative X region

Query response           POS|NEG|BIP <newline><^END>

Example                   OUTPUT @Hp4155;":PAGE:KSW:DISP:REGION:X POS"  
  
                          OUTPUT @Hp4155;":PAGE:KSW:DISP:REGION:X?"  
                          ENTER @Hp4155; A\$

---

## :PAGE:KSWEEP:DISPLAY:REGION:Y

This command sets the display region of Y axis for knob sweep.

At \*RST, this value is POSitive.

Syntax                   :PAGE:KSWEEP:DISPLAY:REGION:Y POSitive|NEGative|BIPolar

Parameter

Parameter	Type	Explanation
POSitive	character	display positive Y region
NEGative	character	display negative Y region
BIPolar	character	display positive and negative Y region

Query response

POS|NEG|BIP <newline><^END>

Example

OUTPUT @Hp4155;":PAGE:KSW:DISP:REGion:Y POS"

OUTPUT @Hp4155;":PAGE:KSW:DISP:REGion:Y?"  
 ENTER @Hp4155; A\$

## :PAGE:KSWweep[:MENU]

This command changes the present display page to KNOB SWEEP page.  
 This command does not have query form.

Syntax

:PAGE:KSWweep[:MENU]

Example

OUTPUT @Hp4155;":PAGE:KSW"

## :PAGE:KSWweep:SCOPY

This command copies the sweep and graphic display settings of KNOB SWEEP page to the corresponding parameters of normal sweep.  
 This command does not have query form.

SCPI Commands  
**PAGE Subsystem**

Syntax                   :PAGE:KSWEEP:SCOPY

Example                 OUTPUT @Hp4155;":PAGE:KSW:SCOPY"

---

### :PAGE:KSWEEP:VAR1:EXTent

This command adjusts the sweep extent of the knob sweep measurement. This parameter is multiplied times the VAR1 range setting to determine the knob sweep range. For example, if the parameter of this command is set to 0.7, and the VAR1 range is set to 2 V, then VAR1 is swept from 0 to 1.4 V.

At \*RST, this value is 0.

Syntax                   :PAGE:KSWEEP:VAR1:EXTent *extent*

Parameter

Parameter	Type	Explanation
<i>extent</i>	numeric	0 to 1

Negative value is not allowed. Output polarity is determined by the :PAGE:KSWEEP:VAR1:POLarity command.

Query response         *extent* <newline><^END>

*extent* is NR3 response data type.

Example                 OUTPUT @Hp4155;":PAGE:KSW:VAR1:EXT 0.1"

OUTPUT @Hp4155;":PAGE:KSW:VAR1:EXT?"  
ENTER @Hp4155;A



---

## :PAGE:KSWEEP:VAR1:MODE

This command sets the SWEEP MODE of VAR1 for knob sweep measurement.  
 At \*RST, this value is **SINGLE**.

Syntax                   :PAGE:KSWEEP:VAR1:MODE **SINGLE|DOUBLE**

Parameter

Parameter	Type	Explanation
SINGLE	character	single stair sweep
DOUBLE	character	double stair sweep

Query response         **SING|DOUB <newline><^END>**

Example

```

OUTPUT @Hp4155;":PAGE:KSW:VAR1:MODE SINGLE"

OUTPUT @Hp4155;":PAGE:KSW:VAR1:MODE?"
ENTER @Hp4155; A$

```

---

## :PAGE:KSWEEP:VAR1:POINTS

This command sets the number of steps for VAR1 of knob sweep measurement.

At \*RST, this value is 101.

Syntax                   :PAGE:KSWEEP:VAR1:POINTS *points* | **MINimum** | **MAXimum**

**PAGE Subsystem**

Parameter

Parameter	Type	Explanation
<i>points</i>	numeric	1 to 1001

Query response

*points* <newline><^END>  
*points* is NR1 response data type.

Example

```
OUTPUT @Hp4155;":PAGE:KSW:VAR1:POIN 101"
OUTPUT @Hp4155;":PAGE:KSW:VAR1:POIN MAX"
OUTPUT @Hp4155;":PAGE:KSW:VAR1:POIN?"
ENTER @Hp4155; A
OUTPUT @Hp4155;":PAGE:KSW:VAR1:POIN? MAX"
ENTER @Hp4155; A
```

**:PAGE:KSweep:VAR1:POLarity**

This command sets the polarity of VAR1 sweep area for knob sweep measurement.

At \*RST, this value is POSitive.

Syntax

:PAGE:KSweep:VAR1:POLarity POSitive|NEGative|BIPolar

Parameter

Parameter	Type	Explanation
POSitive	character	sweep in positive X direction
NEGative	character	sweep in negative X direction
BIPolar	character	sweep in positive and negative X directions

Query response            POS|NEG|BIP <newline><^END>

Example                    OUTPUT @Hp4155;":PAGE:KSW:VAR1:POL POS"  
                           OUTPUT @Hp4155;":PAGE:KSW:VAR1:POL?"  
                           ENTER @Hp4155; A\$

## :PAGE:KSW:VAR1:RANGe

This command sets the range of VAR1 for knob sweep measurement.  
 At \*RST, this value is 1 V.

Syntax                    :PAGE:KSW:VAR1:RANGe *range*

Parameter

Parameter	Type	Explanation
<i>range</i>	numeric	0 to 200 V or 0 to 1 A

Query response            *range* <newline><^END>  
*range* is NR3 response data.

Example                    OUTPUT @Hp4155;":PAGE:KSW:VAR1:RANG 1"  
                           OUTPUT @Hp4155;":PAGE:KSW:VAR1:RANG?"  
                           ENTER @Hp4155;A

---

## :PAGE:KSweep:VAR1:STIME

This command sets the step time (length of each step) for knob sweep measurement.

At \*RST, this value is 0.5 ms.

Syntax                   :PAGE:KSweep:VAR1:STIME *step\_time* | MINimum | MAXimum

Parameter

Parameter	Type	Explanation
<i>step_time</i>	numeric	0.5E-3 to 100E-3   Resolution: 100 $\mu$ s

Query response

*step\_time* <newline><^END>

*step\_time* is NR3 response data type.

Example

OUTPUT @Hp4155;":PAGE:KSW:VAR1:STIM 0.005"

OUTPUT @Hp4155;":PAGE:KSW:VAR1:STIM MAX"

OUTPUT @Hp4155;":PAGE:KSW:VAR1:STIM?"

ENTER @Hp4155; A

OUTPUT @Hp4155;":PAGE:KSW:VAR1:STIM? MAX"

ENTER @Hp4155; A

---

## :PAGE:KSweep:Y

This command selects the measurement channel name of Y axis for knob sweep measurement.

At \*RST, this value is I3.

Syntax                   :PAGE:KSWEEP:Y *var\_name*

Parameter

Parameter	Type	Explanation
<i>var_name</i>	string	previously defined <i>measurement</i> channel name

Query response

*var\_name* <newline><^END>

*var\_name* is string response data, but does not contain double quote characters at the beginning and end of the string.

Example

OUTPUT @Hp4155;":PAGE:KSW:Y 'VD' "

OUTPUT @Hp4155;":PAGE:KSW:Y?"

ENTER @Hp4155;A\$

## :PAGE:MEASure:MSETup:ITIME:LONG:APERture?

This command returns the LONG integration time in terms of the APERTURE, which means time.

The **APERture** value is related to **NPLCycles** by the following equation:

$$APERture = NPLCycles / selected\ line\ frequency$$

This command has query form *only*.

At \*RST, this value is 16/*selected line frequency*.

Syntax

:PAGE:MEASure:MSETup:ITIME:LONG:APERture?

Query response

*aperture* <newline><^END>

*aperture* is NR3 response data type.

SCPI Commands  
**PAGE Subsystem**

Example                    OUTPUT @Hp4155;" :PAGE:MEAS:MSET:ITIM:LONG:APER?"  
                          ENTER @Hp4155;A

---

**:PAGE:MEASure:MSETup:ITIMe:LONG[:NPLCycle]**

This command sets the LONG integration time in terms of the Number of Power Line Cycles.

At \*RST, this value is 16.

Syntax                    :PAGE:MEASure:MSETup:ITIMe:LONG [ :NPLCycle ]  
                          *nplcycle* | MINimum | MAXimum

Parameter

Parameter	Type	Explanation
<i>nplcycle</i>	numeric	2 to 100

Query response            *nplcycle* <newline><^END>  
*nplcycle* is NR3 response data type.

Example                    OUTPUT @Hp4155;" :PAGE:MEAS:MSET:ITIM:LONG 16"  
  
                          OUTPUT @Hp4155;" :PAGE:MEAS:MSET:ITIM:LONG MAX"  
  
                          OUTPUT @Hp4155;" :PAGE:MEAS:MSET:ITIM:LONG?"  
                          ENTER @Hp4155;A  
  
                          OUTPUT @Hp4155;" :PAGE:MEAS:MSET:ITIM:LONG? MAX"  
                          ENTER @Hp4155;A

---

## :PAGE:MEASure:MSETup:ITIME:MEDIum:APERture?

This command returns the MEDIUM integration time in terms of the APERTURE, which means time.

This command has query form *only*.

At \*RST, this value is *1/selected line frequency*.

Syntax                               :PAGE:MEASure:MSETup:ITIME:MEDIum:APERture?

Query response                      *aperture* <newline><^END>

*aperture* is NR3 response data type.

Example                               OUTPUT @Hp4155;":PAGE:MEAS:MSET:ITIM:MED:APER?"  
                                      ENTER @Hp4155;A

---

## :PAGE:MEASure:MSETup:ITIME:MEDIum:NPLCycles?

This command returns the MEDIUM integration time in terms of the Number of Power Line Cycles.

The returned value is always 1 because the medium table is fixed.

This command has query form *only*.

At \*RST, this value is 1.

Syntax                               :PAGE:MEASure:MSETup:ITIME:MEDIum:NPLCycles?

Query response                      *nplcycles* <newline><^END>

*nplcycles* is NR3 response data type.

**PAGE Subsystem**

Example                    `OUTPUT @Hp4155;":PAGE:MEAS:MSET:ITIM:MED:NPLC?"`  
                           `ENTER @Hp4155;A`

---

**:PAGE:MEASure:MSETup:ITIME[:MODE]**

This command selects the INTEGRATION TIME.

At \*RST, this value is `SHORT`.

Syntax                    `:PAGE:MEASure:MSETup:ITIME[:MODE]SHORT|LONG|MEDIUM`

Parameter

Parameter	Type	Explanation
<code>SHORT</code>	character	short integration time
<code>LONG</code>	character	long integration time
<code>MEDIUM</code>	character	medium integration time

Query response            `SHORT|LONG|MED <newline><^END>`

Example                    `OUTPUT @Hp4155;":PAGE:MEAS:MSET:ITIM LONG"`  
                           `OUTPUT @Hp4155;":PAGE:MEAS:MSET:ITIM?"`  
                           `ENTER @Hp4155;A$`

---

**:PAGE:MEASure:MSETup:ITIME:SHORT[:APERTure]**

This command sets the `SHORT` integration time in terms of the `APERTURE`, which means time.

The parameter has units of seconds.



At \*RST, this value is 640  $\mu$ s.

Syntax                   :PAGE:MEASure:MSETup:ITIME:SHORT [ :APERTure ]  
*aperture*|MINimum|MAXimum

Parameter

Parameter	Type	Explanation
<i>aperture</i>	numeric	8E-5 to 1.92E-3  s

Query response

*aperture* <newline><^END>  
*aperture* is NR3 response data type.

Example

```
OUTPUT @Hp4155;":PAGE:MEAS:MSET:ITIM:SHORT 1E-3"
OUTPUT @Hp4155;":PAGE:MEAS:MSET:ITIM:SHORT MIN"
OUTPUT @Hp4155;":PAGE:MEAS:MSET:ITIM:SHORT?"
ENTER @Hp4155;A
OUTPUT @Hp4155;":PAGE:MEAS:MSET:ITIM:SHORT? MIN"
ENTER @Hp4155;A
```

---

## :PAGE:MEASure:MSETup:ITIME:SHORT:NPLCycles?

This command returns the SHORT integration time in terms of the Number of Power Line Cycles.

The **NPLCycle** value is related to **APERTure** by the equation:

$$NPLCycles = APERTure * selected\ line\ frequency$$

This command has query form *only*.

At \*RST, this value is 640  $\mu$ s \* *selected line frequency*.

SCPI Commands  
**PAGE Subsystem**

Syntax                               :PAGE:MEASure:MSETup:ITIME:SHORT:NPLCycles?

Query response                    *nplcycle* <newline><^END>

*nplcycle* is NR3 response data type.

Example                            OUTPUT @Hp4155;":PAGE:MEAS:MSET:ITIM:SHORT:NPLC?"  
ENTER @Hp4155;A

---

### :PAGE:MEASure:MSETup[:MENU]

This command changes the present display page to MEASURE: MEASURE SETUP page.

This command does not have query form.

Syntax                            :PAGE:MEASure:MSETup[:MENU]

Example                            OUTPUT @Hp4155;":PAGE:MEAS:MSET"

---

### :PAGE:MEASure:MSETup:SMU<n>|:VMU<n> :RANGe

This command sets the measurement RANGE of SMU<n> or VMU<n>.

<n> is required to specify SMU or VMU number. Valid numbers are SMU1 through SMU6 (depending on the configuration) and VMU1 through VMU2.

If the **RANGe:MODE** is **AUTO**, this parameter is not used.

The specified SMU or VMU must not be **DISable**.

Syntax                   :PAGE:MEASure:MSETup:SMU<n>|:VMU<n>:RANGe  
*range*|MINimum|MAXimum

Parameter

Parameter	Type	Explanation
<i>range</i>	numeric	For SMU 2, 20, 40, 100, 200 V  10E-12, 100E-12, 1E-9, 10E-9, 100E-9, 1E-6, 10E-6, 100E-6, 1E-3, 10E-3, 100E-3, 1 A  For VMU 0.2, 2, 20 V

Query response           *range* <newline><^END>

*range* is NR3 response data type.

Example

OUTPUT @Hp4155;":PAGE:MEAS:MSET:SMU1:RANG 2"

OUTPUT @Hp4155;":PAGE:MEAS:MSET:VMU1:RANG MAX"

OUTPUT @Hp4155;":PAGE:MEAS:MSET:SMU1:RANG?"  
 ENTER @Hp4155;A

OUTPUT @Hp4155;":PAGE:MEAS:MSET:SMU1:RANG? MAX"  
 ENTER @Hp4155;A

---

## :PAGE:MEASure:MSETup:SMU<n>|:VMU<n> :RANGe:MODE

This command selects the ranging MODE of SMU<n> or VMU<n>.

<n> is required to specify SMU or VMU number. Valid numbers are SMU1 through SMU6 (depending on the configuration) and VMU1 through VMU2.

**PAGE Subsystem**

The specified SMU or VMU must not be DISable.

Syntax

```
:PAGE:MEASure:MSETup:SMU<n>|:VMU<n>:RANGe:MODE
AUTO|FIXed|LIMited
```

Parameter

Parameter	Type	Explanation
AUTO	character	auto range mode
FIXed	character	fixed range mode
LIMited	character	limited auto range mode

Query response

```
AUTO|FIX|LIM <newline><^END>
```

Example

```
OUTPUT @Hp4155;":PAGE:MEAS:MSET:SMU1:RANG:MODE AUTO"
OUTPUT @Hp4155;":PAGE:MEAS:MSET:SMU1:RANG:MODE?"
ENTER @Hp4155;A$
```

**:PAGE:MEASure:MSETup:WTIME**

This command sets the WAIT TIME multiplier for the measurement. The default wait time is multiplied by this value.

$$\text{Actual Wait Time} = (\text{Default Wait Time}) * \text{wait time}$$

At \*RST, this value is 1.

Syntax

```
:PAGE:MEASure:MSETup:WTIME wait_time|MINimum|MAXimum
```

Parameter

Parameter	Type	Explanation
<i>wait_time</i>	numeric	0 to 10 with resolution 0.1.

Query response            *wait\_time* <newline><^END>  
*wait\_time* is NR3 response data type.

Example                    OUTPUT @Hp4155;":PAGE:MEAS:MSET:WTIM 1.0"  
                               OUTPUT @Hp4155;":PAGE:MEAS:MSET:WTIM MAX"  
                               OUTPUT @Hp4155;":PAGE:MEAS:MSET:WTIM?"  
                               ENTER @Hp4155;A  
                               OUTPUT @Hp4155;":PAGE:MEAS:MSET:WTIM? MAX"  
                               ENTER @Hp4155;A

**:PAGE:MEASure:MSETup:ZCANcel  
 :SMU<n>?:VMU<n>?**

This command query returns whether the ZERO OFFSET CANCEL mode is enabled for the specified unit.

If :PAGE:MEAS:MSET:ZCANcel[:STATe] is OFF, this query always returns 0.

<n> is required to specify SMU or VMU number. Valid numbers are SMU1 through SMU6 (depending on the configuration) and VMU1 through VMU2.

The specified SMU or VMU must not be DISable.

This command has query form *only*.

Syntax                    :PAGE:MEASure:MSETup:ZCANcel:SMU<n>?:VMU<n>?

Query response            0|1 <newline><^END>

Parameter	Type	Explanation
0	boolean	zero offset cancel is not enabled.
1	boolean	zero offset cancel is enabled.

**PAGE Subsystem**

Example                    `OUTPUT @Hp4155;":PAGE:MEAS:MSET:ZCAN:SMU1?"`  
                           `ENTER @Hp4155;A`

See also                    `:PAGE:MEAS:MSET:ZCAN[:STATe]`

**:PAGE:MEASure:MSETup:ZCANcel[:STATe]**

This command controls whether the ZERO OFFSET CANCEL mode is enabled.

At \*RST, this value is OFF.

Syntax                    `:PAGE:MEASure:MSETup:ZCANcel [ :STATe ] OFF|ON|0|1`

Parameter

Parameter	Type	Explanation
OFF or 0	boolean	zero offset cancel is not enabled for any units.
ON or 1	boolean	zero offset cancel is enabled depending on the settings of each unit.

Query response            `0|1 <newline><^END>`

Example                    `OUTPUT @Hp4155;":PAGE:MEAS:MSET:ZCAN ON"`  
                           `OUTPUT @Hp4155;":PAGE:MEAS:MSET:ZCAN?"`  
                           `ENTER @Hp4155;A`

---

## :PAGE:MEASure:OSEquence[:MENU]

This command changes the present display page to MEASURE: OUTPUT SEQUENCE page.

This command does not have query form.

Syntax                   :PAGE:MEASure:OSEquence [ :MENU ]

Example                 OUTPUT @Hp4155; ":PAGE:MEAS:OSEQ"

---

## :PAGE:MEASure:OSEquence:MODE

This command selects the output sequence mode for sampling measurement.

You use this command only if the measurement mode is sampling.

At \*RST, this value is **SIMultaneous** for sampling measurement.

Syntax                   :PAGE:MEASure:OSEquence:MODE SEQuential|SIMultaneous

Parameter

Parameter	Type	Explanation
SEQuential	character	sequential output
SIMultaneous	character	simultaneous output

Query response         SEQ|SIM <newline><^END>

Example                 OUTPUT @Hp4155; ":PAGE:MEAS:OSEQ:MODE SIM"

OUTPUT @Hp4155; ":PAGE:MEAS:OSEQ:MODE?"  
 ENTER @Hp4155; A\$

---

## :PAGE:MEASure:OSEquence:OSEquence

This command sets the OUTPUT SEQUENCE.

The source channels output in the order specified by the OUTPUT SEQUENCE.

Unspecified units output in default order after the specified units.

At \*RST, the output sequence is SMU1-SMU2-SMU3-SMU4-SMU5-SMU6-VSU1-VSU2-PGU1-PGU2.

Syntax                    `:PAGE:MEASure:OSEquence:OSEquence unit { ,unit } | DEFault`

Parameter

Parameter	Type	Explanation
<i>unit</i>	string	SMU1 SMU2 SMU3 SMU4 SMU5 SMU6 VSU1 VSU2 PGU1 PGU2
<i>DEFault</i>	character	SMU1,SMU2,SMU3,SMU4,SMU5,SMU6,VSU1,VSU2,PGU1,PGU2

Query response

`unit { ,unit } <newline><^END>`

Response is a list of units separated by commas, and is string response data, but does not contain double quote characters at the beginning and end of the string.

Example

```
OUTPUT @Hp4155;":PAGE:MEAS:OSEQ:OSEQ SMU4,PGU1,SMU3,SMU1"
The result order is SMU4-PGU1-SMU3-SMU1-SMU2-SMU5-SMU6-VSU1-VSU2-PGU2.

OUTPUT @Hp4155;":PAGE:MEAS:OSEQ:OSEQ?"
ENTER @Hp4155;A$
```



---

## **:PAGE:MEASure:OSEquence:TRIGger:FUNCtion**

This command selects the trigger function.

At \*RST, this value is **OUTPut**.

Syntax                                    :**PAGE:MEASure:OSEquence:TRIGger:FUNCtion** INPut|OUTPut

Parameter

<b>Parameter</b>	<b>Type</b>	<b>Explanation</b>
INPut	character	trigger input function
OUTPut	character	trigger output function

Query response                        INP|OUTP <newline><^END>

Example                                 OUTPUT @Hp4155;":PAGE:MEAS:OSEQ:TRIG:FUNC INP"  
  
                                        OUTPUT @Hp4155;":PAGE:MEAS:OSEQ:TRIG:FUNC?"  
                                        ENTER @Hp4155;A\$

---

## **:PAGE:MEASure:OSEquence:TRIGger:POLarity**

This command sets the **POLARITY** of trigger signal.

At \*RST, this value is **POSitive**.

Syntax                                    :**PAGE:MEASure:OSEquence:TRIGger:POLarity** POSitive|NEGative

SCPI Commands  
**PAGE Subsystem**

Parameter

Parameter	Type	Explanation
POSitive	character	polarity is positive
NEGative	character	polarity is negative

Query response

POS|NEG <newline><^END>

Example

OUTPUT @Hp4155;":PAGE:MEAS:OSEQ:TRIG:POL POS"

OUTPUT @Hp4155;":PAGE:MEAS:OSEQ:TRIG:POL?"

ENTER @Hp4155;A\$

## :PAGE:MEASure:OSEQuence:TRIGger[:STATe]

This command controls whether the trigger function is enabled.

At \*RST, this value is OFF.

Syntax

:PAGE:MEASure:OSEQuence:TRIGger[:STATe]OFF|ON|0|1

Parameter

Parameter	Type	Explanation
OFF or 0	boolean	trigger function is disabled
ON or 1	boolean	trigger function is enabled

Query response

0|1 <newline><^END>

Example

OUTPUT @Hp4155;":PAGE:MEAS:OSEQ:TRIG ON"

OUTPUT @Hp4155;":PAGE:MEAS:OSEQ:TRIG?"

ENTER @Hp4155;A

---

## :PAGE:MEASure:OSEquence:TRIGger:TIME

This command sets the trigger output timing.

If TRIGger:FUNCTion is INPut, this parameter is not used.

At \*RST, this value is 0, which means free run.

Syntax                               :PAGE:MEASure:OSEquence:TRIGger:TIME *time*|MINimum|MAXimum

Parameter

Parameter	Type	Explanation
<i>time</i>	numeric	0 to 1  when SMU pulse is not used  0 to 0.0327 or pulse width, whichever is shorter.  when SMU pulse is used

Query response                   *time* <newline><^END>

*time* is NR3 response data type.

Example

```
OUTPUT @Hp4155;":PAGE:MEAS:OSEQ:TRIG:TIME 0.01"
```

```
OUTPUT @Hp4155;":PAGE:MEAS:OSEQ:TRIG:TIME 0.01 MAX"
```

```
OUTPUT @Hp4155;":PAGE:MEAS:OSEQ:TRIG:TIME?"
ENTER @Hp4155;A
```

```
OUTPUT @Hp4155;":PAGE:MEAS:OSEQ:TRIG:TIME? MAX"
ENTER @Hp4155;A
```

SCPI Commands  
**PAGE Subsystem**

---

**:PAGE:MEASure:PGUSetup:CONStant:PGU<n>  
[:SOURce]**

This command sets the constant SOURCE value of PGU<n>.

<n> is required to specify PGU number. Valid PGU numbers are PGU1 through PGU2.

You use this command only if the specified PGU is set to V mode (not VPULSE) by the :PAGE:CHAN:PGU<n>:MODE command.

At \*RST, this value is 0.

Syntax                   :PAGE:MEASure:PGUSetup:CONStant:PGU<n>[:SOURce]  
*source*|MINIMUM|MAXimum

Parameter

Parameter	Type	Explanation
<i>source</i>	numeric	-40 to 40 V

Query response           *source* <newline><^END>

*source* is NR3 response data type.

Example

```
OUTPUT @Hp4155;":PAGE:MEAS:PGUS:CONS:PGU1 10"
OUTPUT @Hp4155;":PAGE:MEAS:PGUS:CONS:PGU1 MAX"
OUTPUT @Hp4155;":PAGE:MEAS:PGUS:CONS:PGU1?"
ENTER @Hp4155;A
OUTPUT @Hp4155;":PAGE:MEAS:PGUS:CONS:PGU1? MAX"
ENTER @Hp4155;A
```

---

## **:PAGE:MEASure:PGUSetup[:MENU]**

This command changes the present display page to MEASURE: PGU SETUP.  
 This command does not have query form.

Syntax                    **:PAGE:MEASure:PGUSetup [ :MENU ]**

Example                    **OUTPUT @Hp4155; ":PAGE:MEAS:PGUS"**

---

## **:PAGE:MEASure:PGUSetup:PULSe:PGU<n>:BASE**

This command sets the BASE VALUE of PGU<n>.

<n> is required to specify PGU number. Valid PGU numbers are PGU1 through PGU2.

You use this command only if the specified PGU is set to **VPULse** mode (not **V**) by the **:PAGE:CHAN:PGU<n>:MODE** command.

At \*RST, this value is 0.

Syntax                    **:PAGE:MEASure:PGUSetup:PULSe:PGU<n>:BASE**  
*base* | **MINimum** | **MAXimum**

Parameter

<b>Parameter</b>	<b>Type</b>	<b>Explanation</b>
<i>base</i>	numeric	−40 to 40 V

Query response            *base* <newline><^END>

*base* is NR3 response data type.

SCPI Commands

**PAGE Subsystem**

Example

```

OUTPUT @Hp4155;":PAGE:MEAS:PGUS:PULS:PGU1:BASE 1"
OUTPUT @Hp4155;":PAGE:MEAS:PGUS:PULS:PGU1:BASE MIN"
OUTPUT @Hp4155;":PAGE:MEAS:PGUS:PULS:PGU1:BASE?"
ENTER @Hp4155;A

OUTPUT @Hp4155;":PAGE:MEAS:PGUS:PULS:PGU1:BASE? MIN"
ENTER @Hp4155;A
    
```

---

**:PAGE:MEASure:PGUSetup:PULSe:PGU<n>:COUNT**

This command sets the output PULSE COUNT of PGU<n>.

<n> is required to specify PGU number. Valid PGU numbers are PGU1 through PGU2.

PGU1:COUNT and PGU2:COUNT are always set to the same value.

You use this command only if the specified PGU is set to VPULse mode (not V) by the :PAGE:CHAN:PGU<n>:MODE command.

At \*RST, this value is 0.

Syntax

```

:PAGE:MEASure:PGUSetup:PULSe:PGU<n>:COUNT
count|MINimum|MAXimum
    
```

Parameter

Parameter	Type	Explanation
<i>count</i>	numeric	0 to 65535  0 means free run

Query response

```

count <newline><^END>
    
```

*count* is NR1 response data type.

```

Example      OUTPUT @Hp4155;":PAGE:MEAS:PGUS:PULS:PGU1:COUNT 10"
            OUTPUT @Hp4155;":PAGE:MEAS:PGUS:PULS:PGU1:COUNT MAX"
            OUTPUT @Hp4155;":PAGE:MEAS:PGUS:PULS:PGU1:COUNT?"
            ENTER @Hp4155;A
            OUTPUT @Hp4155;":PAGE:MEAS:PGUS:PULS:PGU1:COUNT? MAX"
            ENTER @Hp4155;A
    
```

---

### **:PAGE:MEASure:PGUSetup:PULSe:PGU<n>:DELay**

This command sets the DELAY TIME of PGU<n>.

<n> is required to specify PGU number. Valid PGU numbers are PGU1 through PGU2.

You use this command only if the specified PGU is set to VPULse mode (not V) by the :PAGE:CHAN:PGU<n>:MODE command.

At \*RST, this value is 0.

Syntax                   :PAGE:MEASure:PGUSetup:PULSe:PGU<n>:DELay  
                           *delay\_time*|MINimum|MAXimum

Parameter

Parameter	Type	Explanation
<i>delay_time</i>	numeric	0 to 10  s

Query response

*delay\_time* <newline><^END>  
*delay\_time* is NR3 response data type.

**PAGE Subsystem**

Example

```

OUTPUT @Hp4155;":PAGE:MEAS:PGUS:PULS:PGU1:DEL 1"
OUTPUT @Hp4155;":PAGE:MEAS:PGUS:PULS:PGU1:DEL MAX"
OUTPUT @Hp4155;":PAGE:MEAS:PGUS:PULS:PGU1:DEL?"
ENTER @Hp4155;A

OUTPUT @Hp4155;":PAGE:MEAS:PGUS:PULS:PGU1:DEL? MAX"
ENTER @Hp4155;A

```

---

**:PAGE:MEASure:PGUSetup:PULSe:PGU<n>  
:IMPedance**

This command sets the output IMPEDANCE of PGU<n>.

<n> is required to specify PGU number. Valid PGU numbers are PGU1 through PGU2.

You use this command only if the specified PGU is set to **VPULse** mode (not **V**) by the **:PAGE:CHAN:PGU<n>:MODE** command.

At \*RST, this value is **LOW**.

Syntax

```
:PAGE:MEASure:PGUSetup:PULSe:PGU<n>:IMPedance LOW|R50
```

Parameter

Parameter	Type	Explanation
LOW	character	low impedance
R50	character	50 $\Omega$

Query response

```
LOW|R50 <newline><^END>
```



Example                    OUTPUT @Hp4155;":PAGE:MEAS:PGUS:PULS:PGU1:IMP LOW"  
                           OUTPUT @Hp4155;":PAGE:MEAS:PGUS:PULS:PGU1:IMP?"  
                           ENTER @Hp4155;A\$

## :PAGE:MEASure:PGUSetup:PULSe:PGU<n> :LEADing

This command sets the leading-edge transition time (LEADING TIME) of PGU<n>.

<n> is required to specify PGU number. Valid PGU numbers are PGU1 through PGU2.

You use this command only if the specified PGU is set to VPULse mode (not V) by the :PAGE:CHAN:PGU<n>:MODE command.

At \*RST, this value is 100 ns.

Syntax                    :PAGE:MEASure:PGUSetup:PULSe:PGU<n>:LEADing  
                           *leading\_time*|MINimum|MAXimum

Parameter

Parameter	Type	Explanation
<i>leading_time</i>	numeric	1E-7 to 1E-2  s

Query response

*leading\_time* <newline><^END>  
*leading\_time* is NR3 response data type.

Example                    OUTPUT @Hp4155;":PAGE:MEAS:PGUS:PULS:PGU1:LEAD 0.001"  
                           OUTPUT @Hp4155;":PAGE:MEAS:PGUS:PULS:PGU1:LEAD MIN"  
                           OUTPUT @Hp4155;":PAGE:MEAS:PGUS:PULS:PGU1:LEAD?"  
                           ENTER @Hp4155;A

SCPI Commands  
**PAGE Subsystem**

```
OUTPUT @Hp4155;":PAGE:MEAS:PGUS:PULS:PGU1:LEAD? MIN"  
ENTER @Hp4155;A
```

---

### **:PAGE:MEASure:PGUSetup:PULSe:PGU<n>:PEAK**

This command sets the PEAK VALUE of PGU<n>.

<n> is required to specify PGU number. Valid PGU numbers are PGU1 through PGU2.

You use this command only if the specified PGU is set to **VPULse** mode (not **V**) by the **:PAGE:CHAN:PGU<n>:MODE** command.

At \*RST, this value is 0.1 V.

Syntax

```
:PAGE:MEASure:PGUSetup:PULSe:PGU<n>:PEAK  
peak|MINimum|MAXimum
```

Parameter

Parameter	Type	Explanation
<i>peak</i>	numeric	-40 to 40 V

Query response

```
peak <newline><^END>
```

*peak* is NR3 response data type.

Example

```
OUTPUT @Hp4155;":PAGE:MEAS:PGUS:PULS:PGU1:PEAK 5"  
  
OUTPUT @Hp4155;":PAGE:MEAS:PGUS:PULS:PGU1:PEAK MAX"  
  
OUTPUT @Hp4155;":PAGE:MEAS:PGUS:PULS:PGU1:PEAK?"  
ENTER @Hp4155;A  
  
OUTPUT @Hp4155;":PAGE:MEAS:PGUS:PULS:PGU1:PEAK? MAX"  
ENTER @Hp4155;A
```

---

## :PAGE:MEASure:PGUSetup:PULSe:PGU<n>:PERiod

This command sets the pulse PERIOD of PGU<n>.

<n> is required to specify PGU number. Valid PGU numbers are PGU1 through PGU2.

PGU1:PERiod and PGU2:PERiod are always set to the same value.

You use this command only if the specified PGU is set to VPULse mode (not V) by the :PAGE:CHAN:PGU<n>:MODE command.

At \*RST, this value is 10 ms.

Syntax                   :PAGE:MEASure:PGUSetup:PULSe:PGU<n>:PERiod  
                           *period* | MINimum | MAXimum

Parameter

Parameter	Type	Explanation
<i>period</i>	numeric	2E-6 to 10 [s]

Query response

*period* <newline><^END>  
*period* is NR3 response data type.

Example

```
OUTPUT @Hp4155;":PAGE:MEAS:PGUS:PULS:PGU1:PER 0.01"
OUTPUT @Hp4155;":PAGE:MEAS:PGUS:PULS:PGU1:PER MIN"
OUTPUT @Hp4155;":PAGE:MEAS:PGUS:PULS:PGU1:PER?"
ENTER @Hp4155;A

OUTPUT @Hp4155;":PAGE:MEAS:PGUS:PULS:PGU1:PER? MIN"
ENTER @Hp4155;A
```

---

## :PAGE:MEASure:PGUSetup:PULSe:PGU<n>:TRailing

This command sets the trailing-edge transition time (TRAILING TIME) of PGU<n>.

<n> is required to specify PGU number. Valid PGU numbers are PGU1 through PGU2.

You use this command only if the specified PGU is set to **VPULse** mode (not **V**) by the **:PAGE:CHAN:PGU<n>:MODE** command.

At \*RST, this value is 100 ns.

Syntax                    :**PAGE:MEASure:PGUSetup:PULSe:PGU<n>:TRailing**  
                           *trailing\_time* | **MINimum** | **MAXimum**

Parameter

Parameter	Type	Explanation
<i>trailing_time</i>	numeric	1E-7 to 1E-2  s

Query response

*trailing\_time* <newline><^END>  
*trailing\_time* is NR3 response data type.

Example

```
OUTPUT @Hp4155;":PAGE:MEAS:PGUS:PULS:PGU1:TRA 0.001"
OUTPUT @Hp4155;":PAGE:MEAS:PGUS:PULS:PGU1:TRA MIN"

OUTPUT @Hp4155;":PAGE:MEAS:PGUS:PULS:PGU1:TRA?"
ENTER @Hp4155;A

OUTPUT @Hp4155;":PAGE:MEAS:PGUS:PULS:PGU1:TRA? MIN"
ENTER @Hp4155;A
```

---

## :PAGE:MEASure:PGUSetup:PULSe:PGU<n>:WIDTh

This command sets the pulse WIDTH of PGU<n>.

<n> is required to specify PGU number. Valid PGU numbers are PGU1 through PGU2.

You use this command only if the specified PGU is set to **VPULse** mode (not **V**) by the :PAGE:CHAN:PGU<n>:MODE command.

At \*RST, this value is 5 ms.

Syntax                   :PAGE:MEASure:PGUSetup:PULSe:PGU<n>:WIDTh  
*width* | MINimum | MAXimum

Parameter

Parameter	Type	Explanation
<i>width</i>	numeric	1E-6 to 9.99  s

Query response           *width* <newline><^END>

*width* is NR3 response data type.

Example

```
OUTPUT @Hp4155;":PAGE:MEAS:PGUS:PULS:PGU1:WIDTH 0.005"
```

```
OUTPUT @Hp4155;":PAGE:MEAS:PGUS:PULS:PGU1:WIDTH MIN"
```

```
OUTPUT @Hp4155;":PAGE:MEAS:PGUS:PULS:PGU1:WIDTH?"
ENTER @Hp4155;A
```

```
OUTPUT @Hp4155;":PAGE:MEAS:PGUS:PULS:PGU1:WIDTH? MIN"
ENTER @Hp4155;A
```

---

**:PAGE:MEASure:SAMPLing:CONStant:SMU<n>  
:COMPLiance**

This command sets the constant COMPLIANCE value of SMU<n> for the sampling measurement.

<n> is required to specify SMU number. Valid SMU numbers are SMU1 through SMU6, depending on the configuration.

The mode of the specified SMU must be V or I.

Syntax

```
:PAGE:MEASure:SAMPLing:CONStant:SMU<n>:COMPLiance  
compliance|MINimum|MAXimum
```

Parameter

Parameter	Type	Explanation
<i>compliance</i>	numeric	–200 to 200 V or –1 to 1 A. The range of this value depends on the type of SMU.

Query response

```
compliance <newline><^END>
```

*compliance* is NR3 response data type.

Example

```
OUTPUT @Hp4155;":PAGE:MEAS:SAMP:CONS:SMU1:COMP 0.1"  
OUTPUT @Hp4155;":PAGE:MEAS:SAMP:CONS:SMU1:COMP MAX"  
OUTPUT @Hp4155;":PAGE:MEAS:SAMP:CONS:SMU1:COMP?"  
ENTER @Hp4155;A  
OUTPUT @Hp4155;":PAGE:MEAS:SAMP:CONS:SMU1:COMP? MAX"  
ENTER @Hp4155;A
```

---

**:PAGE:MEASure:SAMPLing:CONStant:SMU<n>  
[:SOURce]**

This command sets the constant SOURCE value of SMU<n> for the sampling measurement.

<n> is required to specify SMU number. Valid SMU numbers are SMU1 through SMU6, depending on the configuration.

The mode of the specified SMU must be V or I.

Syntax                    :**PAGE:MEASure:SAMPLing:CONStant:SMU<n>** [**:SOURce**]  
*source* | **MINimum** | **MAXimum**

Parameter

Parameter	Type	Explanation
<i>source</i>	numeric	–200 to 200 V or –1 to 1 A. The range of this value depends on the type of SMU.

Query response            *source* <newline><^END>

*source* is NR3 response data type.

Example

```
OUTPUT @Hp4155;":PAGE:MEAS:SAMP:CONS:SMU1 10"
OUTPUT @Hp4155;":PAGE:MEAS:SAMP:CONS:SMU1 MAX"
OUTPUT @Hp4155;":PAGE:MEAS:SAMP:CONS:SMU1?"
ENTER @Hp4155;A
OUTPUT @Hp4155;":PAGE:MEAS:SAMP:CONS:SMU1? MAX"
ENTER @Hp4155;A
```

---

**:PAGE:MEASure:SAMPLing:CONStant:VSU<n>  
[:SOURce]**

This command sets the constant SOURCE value of VSU<n> for the sampling measurement.

<n> is required to specify VSU number. Valid VSU numbers are VSU1 through VSU2.

The specified VSU must not be DISAbLe.

Syntax

```
:PAGE:MEASure:SAMPLing:CONStant:VSU<n>[:SOURce]  
source|MINimum|MAXimum
```

Parameter

Parameter	Type	Explanation
<i>source</i>	numeric	–20 V to 20 V

Query response

```
source <newline><^END>  
source is NR3 response data type.
```

Example

```
OUTPUT @Hp4155;":PAGE:MEAS:SAMP:CONS:VSU1 10"  
  
OUTPUT @Hp4155;":PAGE:MEAS:SAMP:CONS:VSU1 MAX"  
  
OUTPUT @Hp4155;":PAGE:MEAS:SAMP:CONS:VSU1?"  
ENTER @Hp4155;A  
  
OUTPUT @Hp4155;":PAGE:MEAS:SAMP:CONS:VSU1? MAX"  
ENTER @Hp4155;A
```



---

## :PAGE:MEASure:SAMPLing:FILTer

This command sets the SMU output filter state for sampling measurement.

Syntax                   :PAGE:MEASure:SAMPLing:FILTer OFF|ON|0|1

Parameter

Parameter	Type	Explanation
OFF or 0	boolean	Filter off
ON or 1	boolean	Filter on

Query response           0|1 <newline><^END>

Example

```
OUTPUT @Hp4155;":PAGE:MEASure:SAMPLing:FILTer ON"
OUTPUT @Hp4155;":PAGE:MEASure:SAMPLing:FILTer?"
ENTER @Hp4155; A
```

---

## :PAGE:MEASure:SAMPLing:HTIME

This command sets the HOLD TIME of sampling measurement.

Syntax                   :PAGE:MEASure:SAMPLing:HTIME *hold\_time*|MINimum|MAXimum

Parameter

Parameter	Type	Explanation
<i>hold_time</i>	numeric	3E-2 to 655.35  s  Resolution: 100 $\mu$ s

SCPI Commands  
**PAGE Subsystem**

Query response            *hold\_time* <newline><^END>  
*hold\_time* is NR3 response data type.

Example                    OUTPUT @Hp4155;":PAGE:MEAS:SAMP:HTIME 1.5"  
  
                          OUTPUT @Hp4155;":PAGE:MEAS:SAMP:HTIME MAX"  
  
                          OUTPUT @Hp4155;":PAGE:MEAS:SAMP:HTIME?"  
                          ENTER @Hp4155;A  
  
                          OUTPUT @Hp4155;":PAGE:MEAS:SAMP:HTIME? MAX"  
                          ENTER @Hp4155;A

---

## :PAGE:MEASure:SAMPling:IINTerval

This command sets the INITIAL INTERVAL for sampling measurement.

Syntax                    :PAGE:MEASure:SAMPling:IINTerval  
                          *initial\_interval* | MINimum | MAXimum

Parameter

Parameter	Type	Explanation
<i>initial_interval</i>	numeric	60E-6 to 65.535 [s]

Query response            *initial\_interval* <newline><^END>  
*initial\_interval* is NR3 response data type.

Example                    OUTPUT @Hp4155;":PAGE:MEAS:SAMP:IINT 0.5"  
  
                          OUTPUT @Hp4155;":PAGE:MEAS:SAMP:IINT MIN"  
  
                          OUTPUT @Hp4155;":PAGE:MEAS:SAMP:IINT?"  
                          ENTER @Hp4155; A

```
OUTPUT @Hp4155;":PAGE:MEAS:SAMP:IINT? MIN"
ENTER @Hp4155; A
```

### :PAGE:MEASure:SAMPLing[:MENU]

This command changes the present display page to MEASURE: SAMPLING SETUP page.

This command does not have query form.

Syntax                               :PAGE:MEASure:SAMPLing[:MENU]

Example                               OUTPUT @Hp4155;":PAGE:MEAS:SAMP"

### :PAGE:MEASure:SAMPLing:MODE

This command sets the MODE for sampling measurement.

The sampling mode determines the sampling interval.

Syntax                               :PAGE:MEASure:SAMPLing:MODE LINear|L10|L25|L50|THINnedout

Parameter

Parameter	Type	Explanation
LINear	character	linear sampling mode
L10	character	logarithmic sampling  10 points per decade
L25	character	logarithmic sampling  25 points per decade
L50	character	logarithmic sampling  50 points per decade
THINnedout	character	thinned-out sampling mode

SCPI Commands  
**PAGE Subsystem**

Query response            `LIN|L10|L25|L50|THIN <newline><^END>`

Example                    `OUTPUT @Hp4155;":PAGE:MEAS:SAMP:MODE LIN"`

`OUTPUT @Hp4155;":PAGE:MEAS:SAMP:MODE?"`  
`ENTER @Hp4155; A$`

---

## **:PAGE:MEASure:SAMPling:PERiod**

This command sets the TOTAL SAMPLING TIME for sampling measurement.

Syntax                    `:PAGE:MEASure:SAMPling:PERiod`  
`total_samp_time|INFinity|MINimum|MAXimum`

Parameter

Parameter	Type	Explanation
<i>total_samp_time</i>	numeric	60E-6 to 1E11 [s]
INFinity	character	no limit [sampling measurement continues until the stop event detected.]

Query response            `total_samp_time <newline><^END>`

*total\_samp\_time* is NR3 response data type.

Example                    `OUTPUT @Hp4155;":PAGE:MEAS:SAMP:PERiod 10"`

`OUTPUT @Hp4155;":PAGE:MEAS:SAMP:PERiod?"`  
`ENTER @Hp4155; A`

---

## :PAGE:MEASure:SAMPling:PERiod:AUTO

AUTO ON sets the PERiod to *initial\_interval\*no\_of\_samples*.

This command is only for LINear mode and is ignored if MODE is L10, L25, L50, or THINnedout.

If you set PERiod *total\_samp\_time*, then AUTO OFF is set.

Syntax                               :PAGE:MEASure:SAMPling:PERiod:AUTO OFF|ON|0|1

Parameter

Parameter	Type	Explanation
OFF or 0	boolean	
ON or 1	boolean	<i>total_samp_time = initial_interval * no_of_samples</i>

Query response                    0|1 <newline><^END>

Example

```
OUTPUT @Hp4155;":PAGE:MEAS:SAMP:PERiod:AUTO ON"
OUTPUT @Hp4155;":PAGE:MEAS:SAMP:PERiod:AUTO?"
ENTER @Hp4155; A
```

---

## :PAGE:MEASure:SAMPling:POINts

This command sets the NUMBER OF SAMPLES for sampling measurement.

Syntax                               :PAGE:MEASure:SAMPling:POINts *no\_of\_samples*|MINimum|MAXimum

**PAGE Subsystem**

Parameter

Parameter	Type	Explanation
<i>no_of_samples</i>	numeric	1 to 10001

Query response

*no\_of\_samples* <newline><^END>  
*no\_of\_samples* is NR1 response data type.

Example

```
OUTPUT @Hp4155;":PAGE:MEAS:SAMP:POINTS 5"
OUTPUT @Hp4155;":PAGE:MEAS:SAMP:POINTS MAX"
OUTPUT @Hp4155;":PAGE:MEAS:SAMP:POINTS?"
ENTER @Hp4155; A
OUTPUT @Hp4155;":PAGE:MEAS:SAMP:POINTS? MAX"
ENTER @Hp4155; A
```

**:PAGE:MEASure:SAMPLing:SCONdition:ECOunt**

This command sets the number of **EVENT** occurrences for the stop condition. Sampling measurement continues until **EVENT** occurs the specified number of times (*event\_number*).

Syntax

```
:PAGE:MEASure:SAMPLing:SCONdition:ECOunt
event_number|MINimum|MAXimum
```

Parameter

Parameter	Type	Explanation
<i>event_number</i>	numeric	1 to 200

Query response            *event\_number* <newline><^END>  
*event\_number* is NR1 response data type.

Example                    OUTPUT @Hp4155;":PAGE:MEAS:SAMP:SCON:ECO 10"  
  
OUTPUT @Hp4155;":PAGE:MEAS:SAMP:SCON:ECO?"  
ENTER @Hp4155;A

## :PAGE:MEASure:SAMPing:SCONdition:EDELay

This command sets the ENABLE DELAY time for the stop condition of sampling measurement.

Syntax                    :PAGE:MEASure:SAMPing:SCONdition:EDELay  
*enable\_delay* | MINimum | MAXimum

Parameter

Parameter	Type	Explanation
<i>enable_delay</i>	numeric	0 to ( <i>initial_interval</i> * 32767)

Query response            *enable\_delay* <newline><^END>  
*enable\_delay* is NR3 response data type.

Example                    OUTPUT @Hp4155;":PAGE:MEAS:SAMP:SCON:EDEL 1.0"  
  
OUTPUT @Hp4155;":PAGE:MEAS:SAMP:SCON:EDEL MAX"  
  
OUTPUT @Hp4155;":PAGE:MEAS:SAMP:SCON:EDEL?"  
ENTER @Hp4155;A  
  
OUTPUT @Hp4155;":PAGE:MEAS:SAMP:SCON:EDEL? MAX"  
ENTER @Hp4155;A

---

## :PAGE:MEASure:SAMPLing:SCONdition:EVENT

This command sets the **EVENT** to use with the **NAME** and **THReshold** to define the stop condition of sampling measurement.

**EVENT** describes the relation between **THReshold** and the value of the **NAME** variable.

Syntax                   :PAGE:MEASure:SAMPLing:SCONdition:EVENT  
                          LOW|HIGH|ABSLow|ABSHigh

Parameter

Parameter	Type	Explanation
LOW	character	NAME <i>value</i> < <i>THReshold</i>
HIGH	character	NAME <i>value</i> > <i>THReshold</i>
ABSLow	character	NAME   <i>value</i>   <   <i>THReshold</i>
ABSHigh	character	NAME   <i>value</i>   >   <i>THReshold</i>

Query response         LOW|HIGH|ABSL|ABSH <newline><^END>

Example

```
OUTPUT @Hp4155;":PAGE:MEAS:SAMP:SCON:EVENT HIGH"  
  
OUTPUT @Hp4155;":PAGE:MEAS:SAMP:SCON:EVENT?"  
ENTER @Hp4155;A$
```

---

## :PAGE:MEASure:SAMPLing:SCONdition:NAME

This command selects the variable **NAME** to use with the **THReshold** and **EVENT** to define the stop condition of sampling measurement.



Syntax                   :PAGE:MEASure:SAMPling:SCONdition:NAME *var\_name*

Parameter

Parameter	Type	Explanation
<i>var_name</i>	string	data variable name

Query response

*var\_name* <newline><^END>

*var\_name* is string response data, but does not contain double quote characters at the beginning and end of the string.

Example

OUTPUT @Hp4155;":PAGE:MEAS:SAMP:SCON:NAME 'VD'"

OUTPUT @Hp4155;":PAGE:MEAS:SAMP:SCON:NAME?"

ENTER @Hp4155;A\$

## :PAGE:MEASure:SAMPling:SCONdition[:STATE]

This command controls whether the sampling stop condition is enabled.

Syntax

:PAGE:MEASure:SAMPling:SCONdition[:STATE]OFF|ON|0|1

Parameter

Parameter	Type	Explanation
OFF or 0	boolean	stop condition is disabled
ON or 1	boolean	stop condition is enabled

Query response

0|1 <newline><^END>

**PAGE Subsystem**

Example                    OUTPUT @Hp4155;":PAGE:MEAS:SAMP:SCON ON"  
                           OUTPUT @Hp4155;":PAGE:MEAS:SAMP:SCON?"  
                           ENTER @Hp4155;A

---

## :PAGE:MEASure:SAMPing:SCONdition:THReshold

This command sets the THReshold value to use with the NAME and EVEnt to define the stop condition of sampling measurement.

Syntax                    :PAGE:MEASure:SAMPing:SCONdition:THReshold  
                           *threshold* | MINimum | MAXimum

Parameter

Parameter	Type	Explanation
<i>threshold</i>	numeric	threshold value to define the stop condition of sampling measurement.

Query response            *threshold* <newline><^END>  
*threshold* is NR3 response data type.

Example                    OUTPUT @Hp4155;":PAGE:MEAS:SAMP:SCON:THR 0.5"  
                           OUTPUT @Hp4155;":PAGE:MEAS:SAMP:SCON:THR?"  
                           ENTER @Hp4155;A

---

**:PAGE:MEASure[:SWEep]:CONStant:SMU<n>  
:COMPLiance**

This command sets the constant COMPLIANCE value of SMU<n> for the sweep measurement.

<n> is required to specify SMU number. Valid SMU numbers are SMU1 through SMU6, depending on the configuration.

You use this command only if the function of the specified SMU is **CONStant** and the mode is not **COMMon**.

At \*RST, this value is:

SMU	COMPLIANCE
SMU1	not defined
SMU2	2 V
SMU3	100 mA
SMU4	100 mA
SMU5 and SMU6	not defined

Syntax                    **:PAGE:MEASure[:SWEep]:CONStant:SMU<n>:COMPLiance**  
*compliance* | MINimum | MAXimum

Parameter

Parameter	Type	Explanation
<i>compliance</i>	numeric	–200 to 200 V or –1 to 1 A. The range of this value depends on the type of SMU.

Query response            *compliance* <newline><^END>  
*compliance* is NR3 response data type.

**PAGE Subsystem**

Example

```
OUTPUT @Hp4155;":PAGE:MEAS:CONS:SMU1:COMP 0.1"
```

```
OUTPUT @Hp4155;":PAGE:MEAS:CONS:SMU1:COMP MAX"
```

```
OUTPUT @Hp4155;":PAGE:MEAS:CONS:SMU1:COMP?"
ENTER @Hp4155;A
```

```
OUTPUT @Hp4155;":PAGE:MEAS:CONS:SMU1:COMP? MAX"
ENTER @Hp4155;A
```

**:PAGE:MEASure[:SWEep]:CONStant:SMU<n>  
[:SOURce]**

This command sets the constant SOURCE value of SMU<n> for the sweep measurement.

<n> is required to specify SMU number. Valid SMU numbers are SMU1 through SMU6, depending on the configuration.

You use this command only if the function of the specified SMU is **CONStant** and the mode is not **COMMon**.

At \*RST, this value is 0 V.

Syntax

```
:PAGE:MEASure [ :SWEep ] :CONStant:SMU<n> [ :SOURce ]
source|MINimum|MAXimum
```

Parameter

Parameter	Type	Explanation
<i>source</i>	numeric	–200 to 200 V or –1 to 1 A The range of this value depends on the type of SMU.

Query response

```
source <newline><^END>
```

*source* is NR3 response data type.

Example                    OUTPUT @Hp4155;":PAGE:MEAS:CONS:SMU1 10"  
                           OUTPUT @Hp4155;":PAGE:MEAS:CONS:SMU1 MAX"  
                           OUTPUT @Hp4155;":PAGE:MEAS:CONS:SMU1?"  
                           ENTER @Hp4155;A  
                           OUTPUT @Hp4155;":PAGE:MEAS:CONS:SMU1? MAX"  
                           ENTER @Hp4155;A

---

### **:PAGE:MEASure[:SWEep]:CONStant:VSU<n> [:SOURce]**

This command sets the constant SOURCE value of VSU<n> for the sweep measurement.

<n> is required to specify VSU number. Valid VSU numbers are VSU1 through VSU2.

You use this command only if the function of the specified VSU is **CONStant**.  
 At \*RST, this value is 0V.

Syntax                    :PAGE:MEASure [ :SWEep ] :CONStant:VSU<n> [ :SOURce ]  
                           *source* | MINimum | MAXimum

Parameter

Parameter	Type	Explanation
<i>source</i>	numeric	–20 to 20 V

Query response            *source* <newline><^END>

*source* is NR3 response data type.

**PAGE Subsystem**

Example

```

OUTPUT @Hp4155;":PAGE:MEAS:CONS:VSU1 10"

OUTPUT @Hp4155;":PAGE:MEAS:CONS:VSU1 MAX"

OUTPUT @Hp4155;":PAGE:MEAS:CONS:VSU1?"
ENTER @Hp4155;A

OUTPUT @Hp4155;":PAGE:MEAS:CONS:VSU1? MAX"
ENTER @Hp4155;A

```

**:PAGE:MEASure[:SWEep]:DELay**

This command sets the DELAY TIME of SMU.

At \*RST, this value is 0.

Syntax

```
:PAGE:MEASure [ :SWEep ] :DELay delay_time | MINimum | MAXimum
```

Parameter

Parameter	Type	Explanation
<i>delay_time</i>	numeric	0 to 65.535 [s] Resolution: 100 $\mu$ s

Query response

```
delay_time <newline><^END>
```

*delay\_time* is NR3 response data type.

Example

```

OUTPUT @Hp4155;":PAGE:MEAS:DEL 1.5"

OUTPUT @Hp4155;":PAGE:MEAS:DEL MIN"

OUTPUT @Hp4155;":PAGE:MEAS:DEL?"
ENTER @Hp4155;A

OUTPUT @Hp4155;":PAGE:MEAS:DEL? MAX"

```

ENTER @Hp4155;A

---

## :PAGE:MEASure[:SWEep]:HTIME

This command sets the HOLD TIME of sweep measurement.  
 At \*RST, this value is 0.

Syntax                               :PAGE:MEASure [ :SWEep ] :HTIME *hold\_time* | MINimum | MAXimum

Parameter

Parameter	Type	Explanation
<i>hold_time</i>	numeric	0 to 655.35  s  Resolution: 10 ms

Query response

*hold\_time* <newline><^END>  
*hold\_time* is NR3 response data type.

Example

```
OUTPUT @Hp4155;":PAGE:MEAS:HTIME 1.5"
OUTPUT @Hp4155;":PAGE:MEAS:HTIME?"
ENTER @Hp4155;A
```

---

## :PAGE:MEASure[:SWEep][:MENU]

This command changes the present display page to MEASure: SWEEP SETUP.  
 This command does not have query form.

SCPI Commands  
**PAGE Subsystem**

Syntax                   :PAGE:MEASure[:SWEep][:MENU]

Example                 OUTPUT @Hp4155;":PAGE:MEAS:SWE"

## :PAGE:MEASure[:SWEep]:PULSe:BASE

This command sets the pulse BASE of SMU.

You use this command only if an SMU is set to VPULse or IPULse mode.

Syntax                   :PAGE:MEASure[:SWEep]:PULSe:BASE *base*|MINimum|MAXimum

Parameter

Parameter	Type	Explanation
<i>base</i>	numeric	–200 to 200 V or –1 to 1 A. The range of this value depends on the type of SMU.

Query response         *base* <newline><^END>

*base* is NR3 response data type.

Example                 OUTPUT @Hp4155;":PAGE:MEAS:PULS:BASE 1.5"

OUTPUT @Hp4155;":PAGE:MEAS:PULS:BASE MIN"

OUTPUT @Hp4155;":PAGE:MEAS:PULS:BASE?"  
 ENTER @Hp4155;A

OUTPUT @Hp4155;":PAGE:MEAS:PULS:BASE? MIN"  
 ENTER @Hp4155;A



---

## :PAGE:MEASure[:SWEep]:PULSe:PERiod

This command sets the pulse PERIOD of SMU.

You use this command only if an SMU is set to **VPULse** or **IPULse** mode.

Syntax                               :PAGE:MEASure [ :SWEep ] :PULSe:PERiod *period* | Minimum | MAXimum

Parameter

Parameter	Type	Explanation
<i>period</i>	numeric	5E-3 to 1  s  Resolution: 100 $\mu$ s

Query response

*period* <newline><^END>

*period* is NR3 response data type.

Example

OUTPUT @Hp4155;":PAGE:MEAS:PULS:PER 0.1"

OUTPUT @Hp4155;":PAGE:MEAS:PULS:PER MAX"

OUTPUT @Hp4155;":PAGE:MEAS:PULS:PER?"

ENTER @Hp4155;A

OUTPUT @Hp4155;":PAGE:MEAS:PULS:PER? MAX"

ENTER @Hp4155;A

---

## :PAGE:MEASure[:SWEep]:PULSe:WIDTh

This command sets the pulse WIDTH of SMU.

You use this command only if an SMU is set to **VPULse** or **IPULse** mode.

**PAGE Subsystem**

Syntax                   :PAGE:MEASure[:SWEep]:PULSe:WIDTh *width*|MINimum|MAXimum

Parameter

Parameter	Type	Explanation
<i>width</i>	numeric	5E-4 to 1E-1  s  Resolution: 100 $\mu$ s

Query response

*width* <newline><^END>

*width* is NR3 response data type.

Example

```
OUTPUT @Hp4155;":PAGE:MEAS:PULS:WIDTH 0.1"
```

```
OUTPUT @Hp4155;":PAGE:MEAS:PULS:WIDTH MAX"
```

```
OUTPUT @Hp4155;":PAGE:MEAS:PULS:WIDTH?"
ENTER @Hp4155;A
```

```
OUTPUT @Hp4155;":PAGE:MEAS:PULS:WIDTH? MAX"
ENTER @Hp4155;A
```

---

## :PAGE:MEASure[:SWEep]:SSTop

This command sets the sweep stop mode for an abnormal status.

The abnormal statuses that can be detected are as follows:

- SMU reaches its compliance setting.
- Current of VSU exceeds  $\pm 100$  mA.
- SMU or VSU oscillates.
- A/D converter overflow occurs.
- Average current of PGU exceeds  $\pm 100$  mA.

At \*RST, this value is OFF.

If you set the SERIES RESISTANCE of SMU<n> to a non-zero value by :PAGE:CHANnels[:CDEFinition]:SMU<n>:SRESistance, this value is automatically changed to **COMP**

Syntax                               :PAGE:MEASure[:SWEep]:SSTop ABNormal|COMpliance|OFF

Parameter

Parameter	Type	Explanation
ABNormal	character	Stop sweep if abnormal status is detected.
COMpliance	character	Stop sweep if some SMU reaches its compliance setting.
OFF	character	Continue sweep even if abnormal status is detected.

If you set the power compliance for VAR1, you cannot specify **OFF**.

Query response                       OFF|ABN|COMP <newline><^END>

Example

```
OUTPUT @Hp4155;":PAGE:MEAS:SST ABN"
OUTPUT @Hp4155;":PAGE:MEAS:SST?"
ENTER @Hp4155;A$
```

---

## :PAGE:MEASure[:SWEep]:VAR1:COMpliance

This command sets the COMPLIANCE value of VAR1.

If the unit type of VAR1 is VSU, this parameter is ignored.

At \*RST, this value is 100 mA.

Syntax                               :PAGE:MEASure[:SWEep]:VAR1:COMpliance  
*compliance* | MINimum | MAXimum

SCPI Commands  
**PAGE Subsystem**

Parameter

Parameter	Type	Explanation
<i>compliance</i>	numeric	–200 V to 200V or –1 A to 1 A The range of this value depends on the unit type of VAR1.

Query response

*compliance* <newline><^END>  
*compliance* is NR3 response data type.

Example

```
OUTPUT @Hp4155;":PAGE:MEAS:VAR1:COMP 100mA"
OUTPUT @Hp4155;":PAGE:MEAS:VAR1:COMP MAX"
OUTPUT @Hp4155;":PAGE:MEAS:VAR1:COMP?"
ENTER @Hp4155; A
OUTPUT @Hp4155;":PAGE:MEAS:VAR1:COMP? MAX"
ENTER @Hp4155; A
```

---

## :PAGE:MEASure[:SWEep]:VAR1:MODE

This command sets the SWEEP MODE of VAR1 for normal (not knob) sweep measurement.

At \*RST, this value is SINGLE.

Syntax

```
:PAGE:MEASure [ :SWEep ] :VAR1:MODE SINGLE|DOUBLE
```

Parameter

Parameter	Type	Explanation
SINGLE	character	single stair sweep
DOUBLE	character	double stair sweep

Query response                    SING|DOUB <newline><^END>

Example                            OUTPUT @Hp4155;":PAGE:MEAS:VAR1:MODE SINGLE"  
  
                                   OUTPUT @Hp4155;":PAGE:MEAS:VAR1:MODE?"  
                                   ENTER @Hp4155; A\$

## :PAGE:MEASure[:SWEep]:VAR1:PCOMpliance

This command sets the power compliance value of VAR1.

If the unit type of VAR1 is VSU, this parameter is ignored.

At \*RST, this value is not defined, but the PCOMpliance:STATe is OFF.

Syntax                            :PAGE:MEASure [ :SWEep ] :VAR1:PCOMpliance  
                                   *pcompliance* | MINimum | MAXimum

Parameter

Parameter	Type	Explanation
<i>pcompliance</i>	numeric	1E-3 to 20 The range of this value depends on the unit type of VAR1.

If SMU for VAR1 unit is set to VPULSE or IPULSE mode, you *cannot* set power compliance for VAR1 unit.

Query response                    *pcompliance* <newline><^END>

*pcompliance* is NR3 response data type.

Example                            OUTPUT @Hp4155;":PAGE:MEAS:VAR1:PCOM 0.5"  
  
                                   OUTPUT @Hp4155;":PAGE:MEAS:VAR1:PCOM MAX"  
  
                                   OUTPUT @Hp4155;":PAGE:MEAS:VAR1:PCOM?"

**PAGE Subsystem**

```
ENTER @Hp4155; A

OUTPUT @Hp4155;":PAGE:MEAS:VAR1:PCOM? MAX"
ENTER @Hp4155; A
```

**:PAGE:MEASure[:SWEep]:VAR1:PCOMpliance:STATe**

This command sets the power compliance of VAR1 to disable.

If SMU for VAR1 unit is set to VPULse or IPULse mode, **STATe** is set to **OFF**. You cannot set power compliance for VAR1.

If the unit type of VAR1 is VSU, **STATe** is ignored.

If power compliance value is set by **PCOMpliance** *pcompliance*, the query returns 1.

At \*RST, this value is **OFF**.

Syntax                   :PAGE:MEASure [ :SWEep ] :VAR1:PCOMpliance:STATe OFF|0

Parameter

Parameter	Type	Explanation
OFF or 0	boolean	power compliance is disabled

Query response           0|1 <newline><^END>

Example

```
OUTPUT @Hp4155;":PAGE:MEAS:VAR1:PCOM:STATE OFF"

OUTPUT @Hp4155;":PAGE:MEAS:VAR1:PCOM:STATE?"
ENTER @Hp4155; A
```

---

## :PAGE:MEASure[:SWEep]:VAR1:SPACing

This command selects the sweep type of VAR1: linear staircase or logarithmic staircase.

At \*RST, this value is LINear.

Syntax                               :PAGE:MEASure [ :SWEep ] :VAR1:SPACing LINear|L10|L25|L50

Parameter

Parameter	Type	Explanation
LINear	character	The sweep is incremented  decremented  by the stepsize until the stop value is reached.
L10	character	The sweep is performed logarithmically  10 steps per decade  between the stop and start values.
L25	character	The sweep is performed logarithmically  25 steps per decade  between the stop and start values.
L50	character	The sweep is performed logarithmically  50 steps per decade  between the stop and start values.

Query response                       LIN|L10|L25|L50 <newline><^END>

Example                               OUTPUT @Hp4155;":PAGE:MEAS:VAR1:SPAC LIN"

OUTPUT @Hp4155;":PAGE:MEAS:VAR1:SPAC?"  
 ENTER @Hp4155; A\$

---

## :PAGE:MEASure[:SWEep]:VAR1:START

This command sets the sweep START value of VAR1.

At \*RST, this value is 0 V.

**PAGE Subsystem**

Syntax `:PAGE:MEASure[:SWEep]:VAR1:START start|MINimum|MAXimum`

Parameter

Parameter	Type	Explanation
<i>start</i>	numeric	−200 to 200 V or −1 to 1 A
	numeric	The range of this value depends on the unit type of VAR1.

Query response

*start* <newline><^END>

*start* is NR3 response data type.

Example

```
OUTPUT @Hp4155;":PAGE:MEAS:VAR1:START 0"
```

```
OUTPUT @Hp4155;":PAGE:MEAS:VAR1:START MIN"
```

```
OUTPUT @Hp4155;":PAGE:MEAS:VAR1:START?"
```

```
ENTER @Hp4155; A
```

```
OUTPUT @Hp4155;":PAGE:MEAS:VAR1:START? MIN"
```

```
ENTER @Hp4155; A
```

**:PAGE:MEASure[:SWEep]:VAR1:STEP**

This command sets the sweep STEP value of VAR1 for the linear sweep. This parameter is not used for logarithmic sweep.

At \*RST, this value is 0.01 V.

Syntax

`:PAGE:MEASure[:SWEep]:VAR1:STEP step|MINimum|MAXimum`



Parameter

Parameter	Type	Explanation
<i>step</i>	numeric	–400 to 400 V or –2 to 2 A. The range of this value depends on the unit type of VAR1.

The polarity of step value is automatically determined by the relation between start and stop values. So, for the step value you specify, only absolute value has meaning. The polarity has no meaning.

Query response

*step* <newline><^END>

*step* is NR3 response data type.

Example

OUTPUT @Hp4155;":PAGE:MEAS:VAR1:STEP 0.01"

OUTPUT @Hp4155;":PAGE:MEAS:VAR1:STEP?"  
 ENTER @Hp4155; A

---

## :PAGE:MEASure[:SWEep]:VAR1:STOP

This command sets the sweep STOP value of VAR1.

At \*RST, this value is 1 V.

Syntax

:PAGE:MEASure [ :SWEep ] :VAR1:STOP *stop* | MINimum | MAXimum

Parameter

Parameter	Type	Explanation
<i>stop</i>	numeric	–200 to 200 V or –1 to 1 A. The range of this value depends on the unit type of VAR1.

SCPI Commands  
**PAGE Subsystem**

Query response            *stop* <newline><^END>  
*stop* is NR3 response data type.

Example                    OUTPUT @Hp4155;":PAGE:MEAS:VAR1:STOP 1"  
  
                          OUTPUT @Hp4155;":PAGE:MEAS:VAR1:STOP MAX"  
  
                          OUTPUT @Hp4155;":PAGE:MEAS:VAR1:STOP?"  
                          ENTER @Hp4155; A  
  
                          OUTPUT @Hp4155;":PAGE:MEAS:VAR1:STOP? MAX"  
                          ENTER @Hp4155; A

---

## :PAGE:MEASure[:SWEep]:VAR2:COMPLIance

This command sets the COMPLIANCE value of VAR2.

You use this command only if there is an SMU whose function (FCTN) is VAR2.

If the unit type of VAR2 is VSU, this parameter is ignored.

At \*RST, this value is 2 V.

Syntax                    :PAGE:MEASure [ :SWEep ] :VAR2:COMPLIance  
                          *compliance* | MINimum | MAXimum

Parameter

Parameter	Type	Explanation
<i>compliance</i>	numeric	–200 to 200 V or –1 to 1 A The range of this value depends on SMU type of VAR2.

Query response                    *compliance* <newline><^END>  
*compliance* is NR3 response data type.

Example                            OUTPUT @Hp4155;":PAGE:MEAS:VAR2:COMP 2"  
                                   OUTPUT @Hp4155;":PAGE:MEAS:VAR2:COMP MAX"  
                                   OUTPUT @Hp4155;":PAGE:MEAS:VAR2:COMP?"  
                                   ENTER @Hp4155; A  
                                   OUTPUT @Hp4155;":PAGE:MEAS:VAR2:COMP? MAX"  
                                   ENTER @Hp4155; A

---

## :PAGE:MEASure[:SWEep]:VAR2:PCOMpliance

This command sets the power compliance value of VAR2.

You use this command only if there is an SMU whose function (FCTN) is VAR2.

If the unit type of VAR2 is VSU, this parameter is ignored.

At \*RST, this value is not defined, but the PCOMpliance:STATe is OFF.

Syntax                            :PAGE:MEASure [ :SWEep ] :VAR2:PCOMpliance  
                                   *pcompliance* | MINimum | MAXimum

Parameter

Parameter	Type	Explanation
<i>pcompliance</i>	numeric	1E-3 to 20 The range of this value depends on SMU type of VAR2.

SCPI Commands  
**PAGE Subsystem**

Query response            *pcompliance* <newline><^END>  
*pcompliance* is NR3 response data type.

Example                    OUTPUT @Hp4155;":PAGE:MEAS:VAR2:PCOM 0.5"  
  
                          OUTPUT @Hp4155;":PAGE:MEAS:VAR2:PCOM MAX"  
  
                          OUTPUT @Hp4155;":PAGE:MEAS:VAR2:PCOM?"  
                          ENTER @Hp4155; A  
  
                          OUTPUT @Hp4155;":PAGE:MEAS:VAR2:PCOM? MAX"  
                          ENTER @Hp4155; A

---

## :PAGE:MEASure[:SWEep]:VAR2:PCOMpliance:STATe

This command sets the power compliance of VAR2 to disable.

You use this command only if there is an SMU whose function (FCTN) is VAR2.

If the unit type of VAR2 is VSU, this parameter is ignored.

If power compliance value is set by **PCOMpliance** *pcompliance*, the query returns 1.

At \*RST, this value is OFF.

Syntax                    :PAGE:MEASure[:SWEep]:VAR2:PCOMpliance:STATe OFF|0

Parameter

Parameter	Type	Explanation
OFF or 0	boolean	power compliance is disabled

Query response            0|1 <newline><^END>

Example                    OUTPUT @Hp4155;":PAGE:MEAS:VAR2:PCOM:STATE OFF"  
  
                           OUTPUT @Hp4155;":PAGE:MEAS:VAR2:PCOM:STATE?"  
                           ENTER @Hp4155; A

---

## :PAGE:MEASure[:SWEep]:VAR2:POINTs

This command sets the number of sweep steps of VAR2.

You use this command only if there is an SMU or VSU whose function (FCTN) is VAR2.

At \*RST, this value is 5.

Syntax                    :PAGE:MEASure [ :SWEep ] :VAR2:POINTs  
                           *no\_of\_steps* | MINimum | MAXimum

Parameter

Parameter	Type	Explanation
<i>no_of_steps</i>	numeric	1 to 128

Query response            *no\_of\_steps* <newline><^END>

*no\_of\_steps* is NR1 response data type.

Example                    OUTPUT @Hp4155;":PAGE:MEAS:VAR2:POINTs 5"  
  
                           OUTPUT @Hp4155;":PAGE:MEAS:VAR2:POINTs MAX"  
  
                           OUTPUT @Hp4155;":PAGE:MEAS:VAR2:POINTs?"  
                           ENTER @Hp4155; A  
  
                           OUTPUT @Hp4155;":PAGE:MEAS:VAR2:POINTs? MAX"

SCPI Commands  
**PAGE Subsystem**

```
ENTER @Hp4155; A
```

---

### :PAGE:MEASure[:SWEep]:VAR2:START

This command sets the sweep START value of VAR2.

You use this command only if there is an SMU or VSU whose function (FCTN) is VAR2.

At \*RST, this value is 20  $\mu$ A.

Syntax

```
:PAGE:MEASure[:SWEep]:VAR2:START start|MINimum|MAXimum
```

Parameter

Parameter	Type	Explanation
<i>start</i>	numeric	–200 to 200 V or –1 to 1 A. The range of this value depends on the unit type of VAR2.

Query response

```
start <newline><^END>
```

*start* is NR3 response data type.

Example

```
OUTPUT @Hp4155;":PAGE:MEAS:VAR2:START 0"
```

```
OUTPUT @Hp4155;":PAGE:MEAS:VAR2:START MIN"
```

```
OUTPUT @Hp4155;":PAGE:MEAS:VAR2:START?"  
ENTER @Hp4155; A
```

```
OUTPUT @Hp4155;":PAGE:MEAS:VAR2:START? MAX"  
ENTER @Hp4155; A
```

---

## :PAGE:MEASure[:SWEep]:VAR2:STEP

This command sets the sweep STEP value of VAR2.

You use this command only if there is an SMU or VSU whose function (FCTN) is VAR2.

At \*RST, this value is 20  $\mu$ A.

Syntax                   :PAGE:MEASure [ :SWEep ] :VAR2:STEP *step* | MINimum | MAXimum

Parameter

Parameter	Type	Explanation
<i>step</i>	numeric	–400 to 400 V or –2 to 2 A The range of this value depends on the unit type of VAR2.

Query response           *step* <newline><^END>

*step* is NR3 response data type.

Example                   OUTPUT @Hp4155; ":PAGE:MEAS:VAR2:STEP 20E-6"

OUTPUT @Hp4155; ":PAGE:MEAS:VAR2:STEP?"  
 ENTER @Hp4155; A

---

## :PAGE:MEASure[:SWEep]:VARD:COMpliance

This command sets the COMPLIANCE value of VARI'.

If the unit type of VARI' is VSU, this parameter is ignored.

You use this command only if there is an SMU whose function (FCTN) is VARI'.

**PAGE Subsystem**

Syntax `:PAGE:MEASure[:SWEep]:VARD:COMPLiance`  
*compliance*|MINimum|MAXimum

Parameter

Parameter	Type	Explanation
<i>compliance</i>	numeric	–200 to 200 V or –1 to 1 A. The range of this value depends on SMU type of VAR1'.

Query response

*compliance* <newline><^END>  
*compliance* is NR3 response data type.

Example

```
OUTPUT @Hp4155;":PAGE:MEAS:VARD:COMP 2"
OUTPUT @Hp4155;":PAGE:MEAS:VARD:COMP MAX"
OUTPUT @Hp4155;":PAGE:MEAS:VARD:COMP?"
ENTER @Hp4155; A
OUTPUT @Hp4155;":PAGE:MEAS:VARD:COMP? MAX"
ENTER @Hp4155; A
```

**:PAGE:MEASure[:SWEep]:VARD:OFFSet**

This command sets the OFFSET value of VAR1'.

For each step of sweep, the output values of VAR1' are determined by the following equation:

$$VAR1' = VAR1 * RATio + OFFSet$$

You use this command only if there is an SMU or VSU whose function (FCTN) is VAR1'.



Syntax                   :PAGE:MEASure[:SWEep]:VARD:OFFSet *offset*|MINimum|MAXimum

Parameter

Parameter	Type	Explanation
<i>offset</i>	numeric	–400 to 400 V or –2 to 2 A. The range of this value depends on the unit type of VAR1'.

Query response

*offset* <newline><^END>  
*offset* is NR3 response data type.

Example

```
OUTPUT @Hp4155;":PAGE:MEAS:VARD:OFFSET 0.5"
OUTPUT @Hp4155;":PAGE:MEAS:VARD:OFFSET?"
ENTER @Hp4155; A
```

See also

:PAGE:MEASure[:SWEep]:VARD:RATio

## :PAGE:MEASure[:SWEep]:VARD:PCOMpliance

This command sets the power compliance value of VARD.

If the unit type of VARD is VSU, this parameter is ignored.

You use this command only if there is an SMU whose function (FCTN) is VAR1'.

Syntax

```
:PAGE:MEASure[:SWEep]:VARD:PCOMpliance
pcompliance|MINimum|MAXimum
```

SCPI Commands  
**PAGE Subsystem**

Parameter

Parameter	Type	Explanation
<i>pcompliance</i>	numeric	1E-3 to 20 The range of this value depends on SMU type of VAR1'.

If SMU for VAR1' unit is set to VPULSE or IPULSE mode, you *cannot* set power compliance for VAR1' unit.

Query response

*pcompliance* <newline><^END>  
*pcompliance* is NR3 response data type.

Example

```
OUTPUT @Hp4155;":PAGE:MEAS:VARD:PCOM 0.5"
OUTPUT @Hp4155;":PAGE:MEAS:VARD:PCOM MAX"
OUTPUT @Hp4155;":PAGE:MEAS:VARD:PCOM?"
ENTER @Hp4155; A

OUTPUT @Hp4155;":PAGE:MEAS:VARD:PCOM? MAX"
ENTER @Hp4155; A
```

---

## :PAGE:MEASure[:SWEep]:VARD:PCOMpliance:STATe

This command sets the power compliance of VAR1' to disable.

If SMU for VAR1' unit is set to VPULSe or IPULSe mode, **STATe** is set to **OFF**. You cannot set power compliance for VAR1'.

If the unit type of VAR1' is VSU, this parameter is ignored.

You use this command only if there is an SMU whose function (FCTN) is VAR1'.

If power compliance value is set by **PCOMpliance** *pcompliance*, the query returns 1.

At \*RST, this value is OFF.

Syntax                   :PAGE:MEASure[:SWEep]:VARD:PCOMpliance:STATe OFF|0

Parameter

Parameter	Type	Explanation
OFF or 0	boolean	power compliance is disabled

Query response           0|1 <newline><^END>

Example                   OUTPUT @Hp4155;":PAGE:MEAS:VARD:PCOM:STATE OFF"  
  
OUTPUT @Hp4155;":PAGE:MEAS:VARD:PCOM:STATE?"  
ENTER @Hp4155; A

## :PAGE:MEASure[:SWEep]:VARD:RATio

This command sets the RATIO of VAR1'.

For each step of sweep, the output values of VAR1' are determined by the following equation:

$$VAR1' = VAR1 * RATio + OFFSet$$

You use this command only if there is an SMU or VSU whose function (FCTN) is VAR1'.

At \*RST, this value is not defined.

Syntax                   :PAGE:MEASure[:SWEep]:VARD:RATio *ratio*|MINimum|MAXimum

**PAGE Subsystem**

Parameter

Parameter	Type	Explanation
<i>ratio</i>	numeric	ratio of VAR1'

Query response

*ratio* <newline><^END>*ratio* is NR3 response data type.

Example

OUTPUT @Hp4155;":PAGE:MEAS:VARD:RATIO 0.1"

OUTPUT @Hp4155;":PAGE:MEAS:VARD:RATIO?"

ENTER @Hp4155; A

See also

:PAGE:MEASure[:SWEep]:VARD:OFFSet

**:PAGE:SCONtrol:KSweep[:START]**

This command enables the start of the Knob SWEEP operation.

After this command is executed, you start operation by rotating the front panel knob.

This command changes the present display page to the KNOB SWEEP page.

Executing this command is about the same as pressing **Green** front-panel key, then pressing **Single** front-panel key.

This command does not have query form.

Syntax

:PAGE:SCONtrol:KSweep [ :START ]

Example                    `OUTPUT @Hp4155;":PAGE:SCON:KSW"`

## **:PAGE:SCONtrol[:MEASurement]:APPend**

This command starts the APPend measurement operation.

The executed measurement mode, SWEep or SAMPLing, is selected by the :PAGE:CHANnels[:CDEFinition]:MODE command.

This command changes the present display page to the GRAPH/LIST: LIST or GRAPH/LIST: GRAPH page, which is selected by the :PAGE:DISPlay[:SETup]:MODE command.

Executing this command is about the same as pressing **Append** front-panel key.

This command does not have query form.

Syntax                    `:PAGE:SCONtrol[:MEASurement]:APPend`

Example                    `OUTPUT @Hp4155;":PAGE:SCON:APP"`

See also                    :PAGE:CHANnels[:CDEFinition]:MODE and :PAGE:DISPlay[:SETup]:MODE

## **:PAGE:SCONtrol[:MEASurement]:REPeat**

This command starts the REPeat measurement operation.

The executed measurement mode, SWEep or SAMPLing, is selected by the :PAGE:CHANnels[:CDEFinition]:MODE command.

**PAGE Subsystem**

This command changes the present display page to the GRAPH/LIST: LIST or GRAPH/LIST: GRAPHICS page, which is selected by the :PAGE:DISPlay[:SETup]:MODE command.

Executing this command is about the same as pressing **Repeat** front-panel key.

This command does not have query form.

Syntax                   :PAGE:SCONtrol [ :MEASurement ] :REPeat

Example                 OUTPUT @Hp4155;":PAGE:SCON:REP"

See also               :PAGE:CHANnels[:CDEFinition]:MODE and :PAGE:DISPlay[:SETup]:MODE

---

**:PAGE:SCONtrol[:MEASurement]:SINGLE**

This command starts the SINGLE measurement operation.

The executed measurement mode, SWEep or SAMPLing, is selected by the :PAGE:CHANnels[:CDEFinition]:MODE command.

This command changes the present display page to the GRAPH/LIST: LIST or GRAPH/LIST: GRAPHICS page, which is selected by the :PAGE:DISPlay[:SETup]:MODE command.

Executing this command is about the same as pressing **Single** front-panel key.

This command does not have query form.

Syntax                   :PAGE:SCONtrol [ :MEASurement ] :SINGle

Example                 OUTPUT @Hp4155;":PAGE:SCON:SING"

See also :PAGE:CHANnels[:CDEFinition]:MODE and :PAGE:DISPlay[:SETup]:MODE

## :PAGE:SCONtrol:STANdby

This command controls the output of standby channels.

This command can be executed only when the present state is IDLE or STANDBY. But the query can be executed for any state.

Executing this command is about the same as pressing **Standby** front-panel key.

At \*RST, this value is OFF.

Syntax :PAGE:SCONtrol:STANdby OFF|ON|0|1

Parameter

Parameter	Type	Explanation
OFF or 0	boolean	change to IDLE state
ON or 1	boolean	change to STANDBY state

Query response 0|1 <newline><^END>

Example OUTPUT @Hp4155;":PAGE:SCON:STAN ON"

OUTPUT @Hp4155;":PAGE:SCON:STAN?"  
 ENTER @Hp4155;A

## :PAGE:SCONtrol:STATe?

This command returns the present state of HP 4155A/4156A.

## SCPI Commands

### PAGE Subsystem

This command has query form *only*.

Syntax `:PAGE:SCONtrol:STATe?`

Query response `IDLE|STAN|MEAS|STR <newline><^END>`

Parameter	Type	Explanation
IDLE	character	IDLE state
STAN	character	STANdby state
MEAS	character	MEASurement state
STR	character	STRess state

Example `OUTPUT @Hp4155;":PAGE:SCON:STAT?"`  
`ENTER @Hp4155;A$`

---

### :PAGE:SCONtrol:STOP

This command stops the currently executing operation (SWEEP, SAMPLING, STRESS, or KNOB SWEEP).

Executing this command is about the same as pressing **Stop** front-panel key.

This command does not have query form.

Syntax `:PAGE:SCONtrol:STOP`

Example `OUTPUT @Hp4155;":PAGE:SCON:STOP"`



---

## :PAGE:SCONtrol:STRESS[:START]

This command starts the STRESS force operation.

This command changes the present display page to the STRESS: STRESS FORCE page.

Executing this command is about the same as pressing **Stress** front-panel key.

This command does not have query form.

Syntax                   :PAGE:SCONtrol:STRESS [ :START ]

Example                   OUTPUT @Hp4155;":PAGE:SCON:STR"

---

## :PAGE:SCONtrol:TRIGger:INPut?

This command waits for the external trigger input and returns 1 just after detecting trigger.

This command has query form *only*.

Syntax                   :PAGE:SCONtrol:TRIGger:INPut? POSitive|NEGative|EITHer

Parameter

Parameter	Type	Explanation
POSitive	character	positive slope is regarded as the trigger
NEGative	character	negative slope is regarded as the trigger
EITHer	character	positive or negative slope is regarded as the trigger

Query response           1 <newline><^END>

SCPI Commands  
**PAGE Subsystem**

Example                    `OUTPUT @Hp4155;":PAGE:SCON:TRIG:INP? POS"`  
                          `ENTER @Hp4155;A`

---

### **:PAGE:SCONtrol:TRIGger:OUTPut:LEVel**

This command outputs a level trigger from the external trigger output terminal.

This command does not have query form.

Syntax                    `:PAGE:SCONtrol:TRIGger:OUTPut:LEVel HIGH|LOW`

Parameter

Parameter	Type	Explanation
HIGH	character	output level is changed to HIGH
LOW	character	output level is changed to LOW

Example                    `OUTPUT @Hp4155;":PAGE:SCON:TRIG:OUTP:LEV HIGH"`

---

### **:PAGE:SCONtrol:TRIGger:OUTPut[:PULSe]**

This command outputs a pulse trigger from the external trigger output terminal.

This command does not have query form.

Syntax                    `:PAGE:SCONtrol:TRIGger:OUTPut[:PULSe] POSitive|NEGative`

Parameter

Parameter	Type	Explanation
POSitive	character	output level is changed to LOW-HIGH-LOW
NEGative	character	output level is changed to HIGH-LOW-HIGH

Example

```
OUTPUT @Hp4155;":PAGE:SCON:TRIG:OUTP POS"
```

## **:PAGE:SCONtrol:ZERO**

This command measures the zero offset that will be used for zero offset cancellation.

Executing this command is about the same as pressing **Green** front-panel key, then pressing **Stop** front-panel key.

This command does not have query form.

Syntax

```
:PAGE:SCONtrol:ZERO
```

Example

```
OUTPUT @Hp4155;":PAGE:SCON:ZERO"
```

## **:PAGE:STress[:CDEFinition]:ALL:DISable**

This command deletes the stress settings of all units (SMU, VSU, PGU, GNDU).

This command does not have query form.

Syntax

```
:PAGE:STress[:CDEFinition]:ALL:DISable
```

SCPI Commands  
**PAGE Subsystem**

Example                    `OUTPUT @Hp4155;":PAGE:STR:ALL:DIS"`

---

## **:PAGE:STress[:CDEFinition]:COMment**

This command sets the USER DEFINED COMMENT for the stress group.  
At \*RST, this value is not defined.

Syntax                    `:PAGE:STress[:CDEFinition]:COMment comment`

Parameter

Parameter	Type	Explanation
<i>comment</i>	string	String of up to 58 characters.

Query response            `comment <newline><^END>`

Example                    `OUTPUT @Hp4155;":PAGE:STR:COMM 'Pulse Stress'"`

```
OUTPUT @Hp4155;":PAGE:STR:COMM?"  
ENTER @Hp4155;A$
```

---

## **:PAGE:STress[:CDEFinition]:GNDU:DISable**

This command disables the stress settings of GNDU.  
This command does not have query form.

Syntax                   :PAGE:STress[:CDEFinition]:GNDU:DISable

Example                  OUTPUT @Hp4155;":PAGE:STR:GNDU:DIS"

---

### :PAGE:STress[:CDEFinition]:GNDU:FUNCTION?

This command returns the function (FCTN) of GNDU for stress.

This command has query form *only*.

Syntax                   :PAGE:STress[:CDEFinition]:GNDU:FUNCTION?

Query response           NSYN|DIS <newline><^END>

When the GNDU is not used, the response data may be DIS (DISable).

Example                  OUTPUT @Hp4155;":PAGE:STR:GNDU:FUNC?"  
ENTER @Hp4155;A\$

---

### :PAGE:STress[:CDEFinition]:GNDU:MODE?

This command returns the output MODE of GNDU for stress.

This command has query form *only*.

Syntax                   :PAGE:STress[:CDEFinition]:GNDU:MODE?

SCPI Commands  
**PAGE Subsystem**

Query response            **COMM|DIS <newline><^END>**

When the GNDU is not used, the response data may be **DIS (DISable)**.

Example                    **OUTPUT @Hp4155;":PAGE:STR:GNDU:MODE?"**  
**ENTER @Hp4155;A\$**

---

## **:PAGE:STress[:CDEFinition]:GNDU:NAME**

This command sets the **NAME** of GNDU for stress.

At \*RST, this value is undefined.

Syntax                    **:PAGE:STress [ :CDEFinition ] :GNDU:NAME *name***

Parameter

<b>Parameter</b>	<b>Type</b>	<b>Explanation</b>
<i>name</i>	string	String of up to 6 alphanumeric characters. 1st character must be alphabet.

Query response            ***name* <newline><^END>**

*name* is string response data, but does not contain double quote characters at the beginning and end of the string.

Example                    **OUTPUT @Hp4155;":PAGE:STR:GNDU:NAME 'VD' "**  
  
**OUTPUT @Hp4155;":PAGE:STR:GNDU:NAME?"**  
**ENTER @Hp4155;A\$**

---

## **:PAGE:STress[:CDEFinition][:MENU]**

This command changes the present display page to STRESS: CHANNEL DEFINITION page.

This command does not have query form.

Syntax                    **:PAGE:STress [ :CDEFinition ] [ :MENU ]**

Example                    **OUTPUT @Hp4155;":PAGE:STR"**

---

## **:PAGE:STress[:CDEFinition]:PGU<n>:DISable**

This command deletes the stress settings of PGU<n>.

<n> is required to specify PGU number. Valid PGU numbers are PGU1 through PGU2.

This command does not have query form.

Syntax                    **:PAGE:STress [ :CDEFinition ] :PGU<n>:DISable**

Example                    **OUTPUT @Hp4155;":PAGE:STR:PGU1:DIS"**

---

## **:PAGE:STress[:CDEFinition]:PGU<n>:FUNCFUNCTION**

This command sets the function (FCTN) of PGU<n> for stress.

<n> is required to specify PGU number. Valid PGU numbers are PGU1 through PGU2.

**PAGE Subsystem**

At \*RST, this value is not defined.

Syntax `:PAGE:STress[:CDEFinition]:PGU<n>:FUNCTION SYNC|NSYNc`

Parameter

Parameter	Type	Explanation
SYNC	character	synchronous stress output
NSYNc	character	non-synchronous [non-stress output]

Query response

SYNC|NSYN|DIS <newline><^END>

If PGU is not used, the response data may be DIS (DISable).

Example

```
OUTPUT @Hp4155;":PAGE:STR:PGU1:FUNC SYNC"
```

```
OUTPUT @Hp4155;":PAGE:STR:PGU1:FUNC?"
ENTER @Hp4155;A$
```

**:PAGE:STress[:CDEFinition]:PGU<n>:MODE**

This command sets the output MODE of PGU<n> for stress.

<n> is required to specify PGU number. Valid PGU numbers are PGU1 through PGU2.

At \*RST, this value is not defined.

Syntax `:PAGE:STress[:CDEFinition]:PGU<n>:MODE V|VPULse`

Parameter

Parameter	Type	Explanation
V	character	voltage output mode
VPULse	character	voltage pulse output mode



Query response            V|VPUL|DIS <newline><^END>

If PGU is not used, the response data may be DIS (DISable).

Example                    OUTPUT @Hp4155;":PAGE:STR:PGU1:MODE V"  
                               OUTPUT @Hp4155;":PAGE:STR:PGU1:MODE?"  
                               ENTER @Hp4155;A\$

## :PAGE:STress[:CDEFinition]:PGU<n>:NAME

This command sets the NAME of PGU<n> for stress.

<n> is required to specify PGU number. Valid PGU numbers are PGU1 through PGU2.

At \*RST, this value is not defined.

Syntax                    :PAGE:STress[:CDEFinition]:PGU<n>:NAME *name*

Parameter

Parameter	Type	Explanation
<i>name</i>	string	String of up to 6 alphanumeric characters. 1st character must be alphabet.

Query response            *name* <newline><^END>

*name* is string response data, but does not contain double quote characters at the beginning and end of the string.

Example                    OUTPUT @Hp4155;":PAGE:STR:PGU1:NAME 'VD'"  
                               OUTPUT @Hp4155;":PAGE:STR:PGU1:NAME?"  
                               ENTER @Hp4155;A\$

---

## **:PAGE:STress[:CDEFinition]:SELEctor<n>:MEASure**

This command selects the relay connection mode of the HP 16440A SMU/PGU selector<n> *for measurement state*.

<n> is required to specify the SMU/PGU selector number. Valid SMU/PGU selector numbers are SELEctor1 through SELEctor4.

At \*RST, this value is OPEN.

Syntax

```
:PAGE:STress [ :CDEFinition ] :SELEctor<n> :MEASure  
SMU|PGU|OPEN|POPen
```

Parameter

<b>Parameter</b>	<b>Type</b>	<b>Explanation</b>
SMU	character	connect to SMU port
PGU	character	connect to PGU port
OPEN	character	disconnect all
POPen	character	disconnect all, but disconnect PGU port with semiconductor switch, not normal switch. This parameter is valid only for selector 1 and 3.

Query response

```
SMU|PGU|OPEN|POP <newline><^END>
```

Example

```
OUTPUT @Hp4155;":PAGE:STR:SEL1:MEAS SMU"  
  
OUTPUT @Hp4155;":PAGE:STR:SEL1:MEAS?"  
ENTER @Hp4155;A$
```

---

## **:PAGE:STress[:CDEFinition]:SELEctor<n>:STress**

This command selects the relay connection mode of the HP 16440A SMU/PGU selector <n> *for stress state*.

<n> is required to specify the SMU/PGU selector number. Valid SMU/PGU selector numbers are SElectoR1 through SElectoR4.

At \*RST, this value is OPEN.

Syntax                   :PAGE:STress[:CDEFinition]:SElectoR<n>:STress  
 SMU|PGU|OPEN|POPen

Parameter

Parameter	Type	Explanation
SMU	character	connect to SMU port
PGU	character	connect to PGU port
OPEN	character	disconnect all
POPen	character	disconnect all, but disconnect PGU port with semiconductor switch, not normal switch. This parameter is valid only for selector 1 and 3.

Query response           SMU|PGU|OPEN|POP <newline><^END>

Example

```
OUTPUT @Hp4155;":PAGE:STR:SEL1:STR SMU"
OUTPUT @Hp4155;":PAGE:STR:SEL1:STR?"
ENTER @Hp4155;A$
```

---

## :PAGE:STress[:CDEFinition]:SMU<n>:DISable

This command deletes the stress settings of SMU<n>.

<n> is required to specify SMU number. Valid SMU numbers are SMU1 through SMU6, depending on the configuration.

This command does not have query form.

Syntax                   :PAGE:STress[:CDEFinition]:SMU<n>:DISable

SCPI Commands  
**PAGE Subsystem**

Example                    `OUTPUT @Hp4155;":PAGE:STR:SMU1:DIS"`

---

## `:PAGE:STress[:CDEFinition]:SMU<n>:FUNction`

This command sets the function (FCTN) of SMU<n> for stress.

<n> is required to specify SMU number. Valid SMU numbers are SMU1 through SMU6, depending on the configuration.

At \*RST, this value is:

<b>SMU</b>	<b>FUNCTION</b>
SMU1	NSYNC
SMU2 to 4	SYNC
SMU5 and SMU6	not defined

Syntax                    `:PAGE:STress [ :CDEFinition ] :SMU<n>:FUNction SYNC|NSYNc`

Parameter

<b>Parameter</b>	<b>Type</b>	<b>Explanation</b>
SYNC	character	synchronous stress output
NSYNc	character	non-synchronous [non-stress output]

Query response            `SYNC|NSYN|DIS <newline><^END>`

If SMU is not used, the response data may be DIS (DISable).

Example                    `OUTPUT @Hp4155;":PAGE:STR:SMU1:FUNC SYNC"`

```
OUTPUT @Hp4155;":PAGE:STR:SMU1:FUNC?"  
ENTER @Hp4155;A$
```

---

## **:PAGE:STress[:CDEFinition]:SMU<n>:MODE**

This command sets the output MODE of SMU<n> for stress.

<n> is required to specify SMU number. Valid SMU numbers are SMU1 through SMU6, depending on the configuration.

At \*RST, this value is:

SMU	OUTPUT MODE
SMU1	COMMon
SMU2 to SMU4	V
SMU5 and SMU6	not defined.

Syntax                    **:PAGE:STress[:CDEFinition]:SMU<n>:MODE V|I|COMMon**

Parameter

Parameter	Type	Explanation
V	character	voltage output mode
I	character	current output mode
COMMon	character	common

Query response            **V|I|COMM|DIS <newline><^END>**

If SMU is not used, the response data may be DIS (DISable).

Example                    **OUTPUT @Hp4155;":PAGE:STR:SMU1:MODE V"**

**OUTPUT @Hp4155;":PAGE:STR:SMU1:MODE?"**  
**ENTER @Hp4155;A\$**

---

## :PAGE:STress[:CDEFinition]:SMU<n>:NAME

This command sets the NAME of SMU<n> for stress.

<n> is required to specify SMU number. Valid SMU numbers are SMU1 through SMU6, depending on the configuration.

At \*RST, this value is:

SMU	NAME
SMU1 through SMU4	V<n>
SMU5 and SMU6	not defined

Syntax                   :PAGE:STress[:CDEFinition]:SMU<n>:NAME *name*

Parameter

Parameter	Type	Explanation
<i>name</i>	string	String of up to 6 alphanumeric characters. 1st character must be alphabet.

Query response

*name* <newline><^END>

*name* is string response data, but does not contain double quote characters at the beginning and end of the string.

Example

```
OUTPUT @Hp4155;":PAGE:STR:SMU1:NAME 'VD' "
```

```
OUTPUT @Hp4155;":PAGE:STR:SMU1:NAME?"  
ENTER @Hp4155;A$
```

---

## **:PAGE:STress[:CDEFinition]:TRIGger:POLarity**

This command sets the POLARITY of trigger signal for stress.

At \*RST, this value is POSitive.

Syntax                    :**PAGE:STress** [ :**CDEFinition** ] :**TRIGger:POLarity**  
**POSitive|NEGative**

Parameter

<b>Parameter</b>	<b>Type</b>	<b>Explanation</b>
POSitive	character	polarity is positive
NEGative	character	polarity is negative

Query response           **POS|NEG** <newline><^END>

Example

```
OUTPUT @Hp4155;":PAGE:STR:TRIG:POL POS"
OUTPUT @Hp4155;":PAGE:STR:TRIG:POL?"
ENTER @Hp4155;A$
```

---

## **:PAGE:STress[:CDEFinition]:TRIGger[:STATe]**

This command controls whether the trigger function is enabled for stress.

At \*RST, this value is DISable.

Syntax                    :**PAGE:STress** [ :**CDEFinition** ] :**TRIGger** [ :**STATe** ] **OFF|ON|0|1**

**PAGE Subsystem**

Parameter

Parameter	Type	Explanation
OFF or 0	boolean	trigger function is disabled
ON or 1	boolean	trigger function is enabled

Query response

0|1 <newline><^END>

Example

```
OUTPUT @Hp4155;":PAGE:STR:TRIG ON"

OUTPUT @Hp4155;":PAGE:STR:TRIG?"
ENTER @Hp4155;A
```

**:PAGE:STress[:CDEFinition]:VSU<n>:DISable**

This command deletes the stress settings of VSU<n>.

<n> is required to specify VSU number. Valid VSU numbers are VSU1 through VSU2.

This command does not have query form.

Syntax

**:PAGE:STress[:CDEFinition]:VSU<n>:DISable**

Example

```
OUTPUT @Hp4155;":PAGE:STR:VSU1:DIS"
```

**:PAGE:STress[:CDEFinition]:VSU<n>:FUNCTION**

This command sets the function (FCTN) of VSU<n> for stress.

<n> is required to specify VSU number. Valid VSU numbers are VSU1 through VSU2.



At \*RST, this value is NSYNC.

Syntax                   :PAGE:STress[:CDEFinition]:VSU<n>:FUNction SYNC|NSYNc

Parameter

Parameter	Type	Explanation
SYNC	character	synchronous stress output
NSYNc	character	non-synchronous  non-stress output

Query response           SYNC|NSYN|DIS <newline><^END>

If VSU is not used, the response data may be DIS (DISable).

Example                   OUTPUT @Hp4155;":PAGE:STR:VSU1:FUNC SYNC"  
  
OUTPUT @Hp4155;":PAGE:STR:VSU1:FUNC?"  
ENTER @Hp4155;A\$

### :PAGE:STress[:CDEFinition]:VSU<n>:MODE?

This command returns the output MODE of VSU<n> for stress.

<n> is required to specify VSU number. Valid VSU numbers are VSU1 through VSU2.

This command has query form *only*.

At \*RST, this value is V.

Syntax                   :PAGE:STress[:CDEFinition]:VSU<n>:MODE?

Query response           V|DIS <newline><^END>

When the specified VSU is not used, the response data may be DIS (DISable).

**PAGE Subsystem**

Example                    `OUTPUT @Hp4155;":PAGE:STR:VSU1:MODE?"`  
                           `ENTER @Hp4155;A$`

---

### **:PAGE:STress[:CDEFinition]:VSU<n>:NAME**

This command sets the NAME of VSU<n> for stress.

<n> is required to specify VSU number. Valid VSU numbers are VSU1 through VSU2.

At \*RST, this value is VSU<n>.

Syntax                    `:PAGE:STress[:CDEFinition]:VSU<n>:NAME name`

Parameter

Parameter	Type	Explanation
<i>name</i>	string	String of up to 6 alphanumeric characters. 1st character must be alphabet.

Query response            `name <newline><^END>`

*name* is string response data, but does not contain double quote characters at the beginning and end of the string.

Example                    `OUTPUT @Hp4155;":PAGE:STR:VSU1:NAME 'VD' "`  
                           `OUTPUT @Hp4155;":PAGE:STR:VSU1:NAME?"`  
                           `ENTER @Hp4155;A$`

---

## :PAGE:STress:FORCe:ACCumulate

This command resets the accumulated stress time to 0.

Query returns the accumulated stress time.

At \*RST, the accumulated stress time is 0.

Syntax                               :PAGE:STress:FORCe:ACCumulate RESet

Parameter

Parameter	Type	Explanation
RESet	character	reset accumulated time to zero

Query response                   *accumulate* <newline><^END>

*accumulate* is NR3 response data type.

Example

OUTPUT @Hp4155;":PAGE:STR:FORC:ACC RES"

OUTPUT @Hp4155;":PAGE:STR:FORC:ACC?"

ENTER @Hp4155;A

---

## :PAGE:STress:FORCe[:MENU]

This command changes the present display page to STRESS: STRESS FORCE.

This command does not have query form.

Syntax                               :PAGE:STress:FORCe[ :MENU ]

SCPI Commands  
**PAGE Subsystem**

Example                    `OUTPUT @Hp4155;":PAGE:STR:FORC"`

---

## **:PAGE:STress:FORCe:STATus**

This command resets the stress status (time and percent) to zero.

Query returns the stress time forced and percent completion of the stress duration setting.

At \*RST, stress time and percent are 0.

Syntax                    `:PAGE:STress:FORCe:STATus RESet`

Parameter

Parameter	Type	Explanation
RESet	character	reset the status to zero

Query response            `time, rate <newline><^END>`

*time* and *rate* are NR3 response data type.

Example                    `OUTPUT @Hp4155;":PAGE:STR:FORC:STAT RES"`

```
OUTPUT @Hp4155;":PAGE:STR:FORC:STAT?"  
ENTER @Hp4155;A,B
```

---

## **:PAGE:STress:SETup:ACCumulate**

This command sets the amount of stress that has already been forced to the device.

At \*RST, this value is 0.

Syntax                   :PAGE:STress:SETup:ACCumulate RESet|*accumulate*

Parameter

Parameter	Type	Explanation
RESet	character	reset accumulated time to zero
<i>accumulate</i>	numeric	0 and above

Query response

*accumulate* <newline><^END>

*accumulate* is NR3 response data type.

Example

OUTPUT @Hp4155;":PAGE:STR:SET:ACC RESet"

OUTPUT @Hp4155;":PAGE:STR:SET:ACC?"

ENTER @Hp4155;A

## :PAGE:STress:SETup:CONStant:PGU<n>[:SOURce]

This command sets the constant SOURCE value of PGU<n> for stress.

<n> is required to specify PGU number. Valid PGU numbers are PGU1 through PGU2.

You use this command only if the specified PGU is set to V mode (not VPULSE) by the :PAGE:STR:PGU<n>:MODE command.

At \*RST, this value is 0.

Syntax

:PAGE:STress:SETup:CONStant:PGU<n> [ :SOURce ]  
*source* | MINimum | MAXimum

Parameter

Parameter	Type	Explanation
<i>source</i>	-40 to 40 V	

SCPI Commands  
**PAGE Subsystem**

Query response            *source* <newline><^END>  
*source* is NR3 response data type.

Example                    OUTPUT @Hp4155;":PAGE:STR:SET:CONS:PGU1 10"  
  
                          OUTPUT @Hp4155;":PAGE:STR:SET:CONS:PGU1 MAX"  
  
                          OUTPUT @Hp4155;":PAGE:STR:SET:CONS:PGU1?"  
                          ENTER @Hp4155;A  
  
                          OUTPUT @Hp4155;":PAGE:STR:SET:CONS:PGU1? MAX"  
                          ENTER @Hp4155;A

---

## **:PAGE:STress:SETup:CONStant:SMU<n>:COMPLIance**

This command sets the constant COMPLIANCE value of SMU<n> for stress.

<n> is required to specify SMU number. Valid SMU numbers are SMU1 through SMU6, depending on the configuration.

The mode of the specified SMU must be V or I.

At \*RST, this value is:

<b>SMU</b>	<b>COMPLIANCE</b>
SMU1	not defined
SMU2 to SMU4	100 mA
SMU5 and SMU6	not defined

Syntax                    :PAGE:STress:SETup:CONStant:SMU<n>:COMPLIance  
                          *compliance*|MINnum|MAXimum

Parameter

Parameter	Type	Explanation
<i>compliance</i>	numeric	–200 to 200 V or –1 to 1 A The range of this value depends on the type of SMU.

Query response

*compliance* <newline><^END>  
*compliance* is NR3 response data type.

Example

```
OUTPUT @Hp4155;":PAGE:STR:SET:CONS:SMU1:COMP 0.1"
OUTPUT @Hp4155;":PAGE:STR:SET:CONS:SMU1:COMP MAX"
OUTPUT @Hp4155;":PAGE:STR:SET:CONS:SMU1:COMP?"
ENTER @Hp4155;A

OUTPUT @Hp4155;":PAGE:STR:SET:CONS:SMU1:COMP? MAX"
ENTER @Hp4155;A
```

---

## :PAGE:STress:SETup:CONStant:SMU<n>[:SOURce]

This command sets the constant SOURCE value of SMU<n> for stress.  
 <n> is required to specify SMU number. Valid SMU numbers are SMU1 through SMU6, depending on the configuration.

The mode of the specified SMU must be V or I.

At \*RST, this value is:

SMU	SOURCE
SMU1	not defined
SMU2 to SMU4	0 V

SCPI Commands

**PAGE Subsystem**

Syntax                   :PAGE:STress:SETup:CONStant:SMU<n> [ :SOURce ]  
*source* | MINimum | MAXimum

Parameter

Parameter	Type	Explanation
<i>source</i>	numeric	–200 to 200 V or –1 to 1 A The range of this value depends on the type of SMU.

Query response

*source* <newline><^END>  
*source* is NR3 response data type.

Example

```
OUTPUT @Hp4155;":PAGE:STR:SET:CONS:SMU1 10"
OUTPUT @Hp4155;":PAGE:STR:SET:CONS:SMU1 MAX"
OUTPUT @Hp4155;":PAGE:STR:SET:CONS:SMU1?"
ENTER @Hp4155;A
OUTPUT @Hp4155;":PAGE:STR:SET:CONS:SMU1? MAX"
ENTER @Hp4155;A
```

---

**:PAGE:STress:SETup:CONStant:VSU<n>[:SOURce]**

This command sets the constant SOURCE value of VSU<n> for stress.

<n> is required to specify VSU number. Valid VSU numbers are VSU1 through VSU2.

The specified VSU must not be DISable.

At \*RST, this value is 0.



Syntax                   :PAGE:STress:SETup:CONStant:VSU<n> [ :SOURce ]  
*source* | MINimum | MAXimum

Parameter

Parameter	Type	Explanation
<i>source</i>	numeric	–20 to 20 V

Query response

*source* <newline><^END>  
*source* is NR3 response data type.

Example

```
OUTPUT @Hp4155;":PAGE:STR:SET:CONS:VSU1 10"
OUTPUT @Hp4155;":PAGE:STR:SET:CONS:VSU1 MAX"
OUTPUT @Hp4155;":PAGE:STR:SET:CONS:VSU1?"
ENTER @Hp4155;A

OUTPUT @Hp4155;":PAGE:STR:SET:CONS:VSU1? MAX"
ENTER @Hp4155;A
```

---

## :PAGE:STress:SETup:DURation

This command sets the stress time in seconds.

If :SETup:MODE is PC0unt, this parameter is not used.

At \*RST, this value is 1 ms.

Syntax

:PAGE:STress:SETup:DURation *duration* | MINimum | MAXimum

SCPI Commands  
**PAGE Subsystem**

Parameter

Parameter	Type	Explanation
<i>duration</i>	numeric	0 to 31536000 s  31536000 s is 1 year  0 means free run

Query response

*duration* <newline><^END>  
*duration* is NR3 response data type.

Example

```
OUTPUT @Hp4155;":PAGE:STR:SET:DUR 10"
OUTPUT @Hp4155;":PAGE:STR:SET:DUR MAX"
OUTPUT @Hp4155;":PAGE:STR:SET:DUR?"
ENTER @Hp4155;A
OUTPUT @Hp4155;":PAGE:STR:SET:DUR? MAX"
ENTER @Hp4155;A
```

---

## :PAGE:STress:SETup:FILTer

This command sets the SMU output filter state for stress.  
 At \*RST, this value is OFF.

Syntax

```
:PAGE:STress:SETup:FILTer OFF|ON|0|1
```

Parameter

Parameter	Type	Explanation
OFF <i>or</i> 0	boolean	filter is turned off.
ON <i>or</i> 1	boolean	filter is turned on.

Query response            O|1 <newline><^END>

Example                    OUTPUT @Hp4155;":PAGE:STR:SET:FILT ON"  
  
                           OUTPUT @Hp4155;":PAGE:STR:SET:FILT?"  
                           ENTER @Hp4155;A

## :PAGE:STress:SETup:HTIME

This command sets the hold time to wait between the non-synchronous (non-stress) channel output and the synchronous channel (stress) output.

At \*RST, this value is 0.

Syntax                    :PAGE:STress:SETup:HTIME *hold\_time*|MINimum|MAXimum

Parameter

Parameter	Type	Explanation
<i>hold_time</i>	numeric	0 to 655.35  s

Query response            *hold\_time* <newline><^END>

*hold\_time* is NR3 response data type.

Example                    OUTPUT @Hp4155;":PAGE:STR:SET:HTIM 0.5"  
  
                           OUTPUT @Hp4155;":PAGE:STR:SET:HTIM MAX"  
  
                           OUTPUT @Hp4155;":PAGE:STR:SET:HTIM?"  
                           ENTER @Hp4155;A  
  
                           OUTPUT @Hp4155;":PAGE:STR:SET:HTIM? MAX"  
                           ENTER @Hp4155;A

---

## **:PAGE:STress:SETup[:MENU]**

This command changes the present display page to STRESS: STRESS SETUP.  
This command does not have query form.

Syntax                    **:PAGE:STress:SETup [ :MENU ]**

Example                    **OUTPUT @Hp4155;":PAGE:STR:SET"**

---

## **:PAGE:STress:SETup:MODE**

This command selects the stress mode.  
If no PGU is set to **VPULse** mode, stress mode must be set to **DURation**.  
At \*RST, this value is **DURation**.

Syntax                    **:PAGE:STress:SETup:MODE DURation|PCOunt**

Parameter

<b>Parameter</b>	<b>Type</b>	<b>Explanation</b>
DURation	character	specify the stress time by duration
PCOunt	character	specify the stress time by pulse count

Query response            **DURation|PCOunt <newline><^END>**

Example                    **OUTPUT @Hp4155;":PAGE:STR:SET:MODE DUR"**

**OUTPUT @Hp4155;":PAGE:STR:SET:MODE?"**  
**ENTER @Hp4155;A\$**

---

## :PAGE:STress:SETup:PCOunt

This command sets the stress time by the number of output pulses.

If :SETup:MODE is DURation, this parameter is not used.

Syntax                   :PAGE:STress:SETup:PCOunt *pcount* | MINimum | MAXimum

Parameter

Parameter	Type	Explanation
<i>pcount</i>	numeric	0 to 65535 0 means free run

Query response

*pcount* <newline><^END>

*pcount* is NR1 response data type.

Example

OUTPUT @Hp4155;":PAGE:STR:SET:PC0 10"

OUTPUT @Hp4155;":PAGE:STR:SET:PC0 MAX"

OUTPUT @Hp4155;":PAGE:STR:SET:PC0?"

ENTER @Hp4155;A

OUTPUT @Hp4155;":PAGE:STR:SET:PC0? MAX"

ENTER @Hp4155;A

---

## :PAGE:STress:SETup:PULSe:PGU<n>:BASE

This command sets the BASE VALUE of PGU<n> for stress.

<n> is required to specify PGU number. Valid PGU numbers are PGU1 through PGU2.

SCPI Commands

**PAGE Subsystem**

The mode of the specified PGU must be **VPULse**.

At \*RST, this value is 0.

Syntax                   :PAGE:STress:SETup:PULSe:PGU<n>:BASE *base*|MINimum|MAXimum

Parameter

Parameter	Type	Explanation
<i>base</i>	numeric	–40 to 40 V

Query response

*base* <newline><^END>

*base* is NR3 response data type.

Example

OUTPUT @Hp4155;":PAGE:STR:SET:PULS:PGU1:BASE 1"

OUTPUT @Hp4155;":PAGE:STR:SET:PULS:PGU1:BASE?"

ENTER @Hp4155;A

---

**:PAGE:STress:SETup:PULSe:PGU<n>:DELay**

This command sets the DELAY TIME of PGU<n> for stress.

<n> is required to specify PGU number. Valid PGU numbers are PGU1 through PGU2.

The mode of the specified PGU must be **VPULse**.

At \*RST, this value is 0.

Syntax

:PAGE:STress:SETup:PULSe:PGU<n>:DELay  
*delay\_time*|MINimum|MAXimum

Parameter

Parameter	Type	Explanation
<i>delay_time</i>	numeric	0 to 10 [s]

Query response

*delay\_time* <newline><^END>  
*delay\_time* is NR3 response data type.

Example

```
OUTPUT @Hp4155;":PAGE:STR:SET:PULS:PGU1:DEL 1"
OUTPUT @Hp4155;":PAGE:STR:SET:PULS:PGU1:DEL MAX"
OUTPUT @Hp4155;":PAGE:STR:SET:PULS:PGU1:DEL?"
ENTER @Hp4155;A

OUTPUT @Hp4155;":PAGE:STR:SET:PULS:PGU1:DEL? MAX"
ENTER @Hp4155;A
```

## :PAGE:STress:SETup:PULSe:PGU<n>:IMPedance

This command sets the output IMPEDANCE of PGU<n> for stress.

<n> is required to specify PGU number. Valid PGU numbers are PGU1 through PGU2.

The mode of the specified PGU must be VPULSe.

At \*RST, this value is LOW.

Syntax

```
:PAGE:STress:SETup:PULSe:PGU<n>:IMPedance LOW|R50
```

Parameter

Parameter	Type	Explanation
LOW	character	low impedance
R50	character	50 Ω

**PAGE Subsystem**

Query response            `LOW|R50 <newline><^END>`

Example                    `OUTPUT @Hp4155;":PAGE:STR:SET:PULS:PGU1:IMP LOW"`

`OUTPUT @Hp4155;":PAGE:STR:SET:PULS:PGU1:IMP?"`

`ENTER @Hp4155;A$`

**:PAGE:STress:SETup:PULSe:PGU<n>:LEADing**

This command sets the leading-edge transition time (LEADING TIME) of PGU<n> for stress.

<n> is required to specify PGU number. Valid PGU numbers are PGU1 through PGU2.

The mode of the specified PGU must be `VPULse`.

At \*RST, this value is 100 ns.

Syntax                    `:PAGE:STress:SETup:PULSe:PGU<n>:LEADing`  
                              `leading_time|MINimum|MAXimum`

Parameter

Parameter	Type	Explanation
<i>leading_time</i>	numeric	100E-9 to 10E-3  s

Query response            `leading_time <newline><^END>`

*leading\_time* is NR3 response data type.

Example                    `OUTPUT @Hp4155;":PAGE:STR:SET:PULS:PGU1:LEAD 0.001"`

`OUTPUT @Hp4155;":PAGE:STR:SET:PULS:PGU1:LEAD MAX"`

`OUTPUT @Hp4155;":PAGE:STR:SET:PULS:PGU1:LEAD?"`

`ENTER @Hp4155;A`



```
OUTPUT @Hp4155;":PAGE:STR:SET:PULS:PGU1:LEAD? MAX"
ENTER @Hp4155;A
```

---

## **:PAGE:STress:SETup:PULSe:PGU<n>:PEAK**

This command sets the PEAK VALUE of PGU<n> for stress.

<n> is required to specify PGU number. Valid PGU numbers are PGU1 through PGU2.

The mode of the specified PGU must be **VPULSe**.

At \*RST, this value is 0.1 V.

Syntax                               :PAGE:STress:SETup:PULSe:PGU<n>:PEAK *peak* | MINimum | MAXimum

Parameter

Parameter	Type	Explanation
<i>peak</i>	numeric	−40 to 40 V

Query response

*peak* <newline><^END>

*peak* is NR3 response data type.

Example

```
OUTPUT @Hp4155;":PAGE:STR:SET:PULS:PGU1:PEAK 5"
```

```
OUTPUT @Hp4155;":PAGE:STR:SET:PULS:PGU1:PEAK MAX"
```

```
OUTPUT @Hp4155;":PAGE:STR:SET:PULS:PGU1:PEAK?"
ENTER @Hp4155;A
```

```
OUTPUT @Hp4155;":PAGE:STR:SET:PULS:PGU1:PEAK? MAX"
ENTER @Hp4155;A
```

---

## :PAGE:STress:SETup:PULSe:PGU<n>:PERiod

This command sets the pulse PERIOD of PGU<n> for stress.

<n> is required to specify PGU number. Valid PGU numbers are PGU1 through PGU2.

PGU1:PERiod and PGU2:PERiod are always set to the same value.

The mode of the specified PGU must be VPULse.

At \*RST, this value is 10 ms.

Syntax

```
:PAGE:STress:SETup:PULSe:PGU<n>:PERiod
period|MINimum|MAXimum
```

Parameter

Parameter	Type	Explanation
<i>period</i>	numeric	2E-6 to 10  s

Query response

```
period <newline><^END>
period is NR3 response data type.
```

Example

```
OUTPUT @Hp4155;":PAGE:STR:SET:PULS:PGU1:PER 0.01"
OUTPUT @Hp4155;":PAGE:STR:SET:PULS:PGU1:PER MAX"
OUTPUT @Hp4155;":PAGE:STR:SET:PULS:PGU1:PER?"
ENTER @Hp4155;A
OUTPUT @Hp4155;":PAGE:STR:SET:PULS:PGU1:PER? MAX"
ENTER @Hp4155;A
```

---

## :PAGE:STress:SETup:PULSe:PGU<n>:TRAILing

This command sets the trailing-edge transition time (TRAILING TIME) of PGU<n> for stress.

<n> is required to specify PGU number. Valid PGU numbers are PGU1 through PGU2.

The mode of the specified PGU must be VPULSe.

At \*RST, this value is 100 ns.

Syntax                    :**PAGE:STress:SETup:PULSe:PGU<n>:TRAILing**  
                           *trailing\_time* | **MINimum** | **MAXimum**

Parameter

Parameter	Type	Explanation
<i>trailing_time</i>	numeric	100 ns to 10 ms

Query response

*trailing\_time* <newline><^END>  
*trailing\_time* is NR3 response data type.

Example

```
OUTPUT @Hp4155;":PAGE:STR:SET:PULS:PGU1:TRAILing 0.001"
OUTPUT @Hp4155;":PAGE:STR:SET:PULS:PGU1:TRAILing MAX"
OUTPUT @Hp4155;":PAGE:STR:SET:PULS:PGU1:TRAILing?"
ENTER @Hp4155;A

OUTPUT @Hp4155;":PAGE:STR:SET:PULS:PGU1:TRAILing? MAX"
ENTER @Hp4155;A
```

---

## **:PAGE:STress:SETup:PULSe:PGU<n>:WIDTh**

This command sets the pulse WIDTH of PGU<n> for stress.

<n> is required to specify PGU number. Valid PGU numbers are PGU1 through PGU2.

The mode of the specified PGU must be **VPULse**.

At \*RST, this value is 5 ms.

Syntax                   **:PAGE:STress:SETup:PULSe:PGU<n>:WIDTh**  
                          *width* | MINimum | MAXimum

Parameter

Parameter	Type	Explanation
<i>width</i>	numeric	1E-6 to 9.99 s

Query response           *width* <newline><^END>

*width* is NR3 response data type.

Example

```
OUTPUT @Hp4155;":PAGE:STR:SET:PULS:PGU1:WIDTH 0.005"  
  
OUTPUT @Hp4155;":PAGE:STR:SET:PULS:PGU1:WIDTH 0.MIN"  
  
OUTPUT @Hp4155;":PAGE:STR:SET:PULS:PGU1:WIDTH?"  
ENTER @Hp4155;A  
  
OUTPUT @Hp4155;":PAGE:STR:SET:PULS:PGU1:WIDTH? MIN"  
ENTER @Hp4155;A
```

---

## :PAGE:STress:SETup:SSTop

This command sets the stress stop mode for an abnormal status.

The abnormal statuses that can be detected are as follows:

- SMU reaches its compliance setting.
- Current of VSU exceeds  $\pm 100$  mA.
- SMU or VSU oscillates.
- A/D converter overflow occurs.
- Average current of PGU exceeds  $\pm 100$  mA.

At \*RST, this value is OFF.

Syntax                                   :PAGE:STress:SETup:SSTop ABNormal| COMPliance|OFF

Parameter

Parameter	Type	Explanation
ABNormal	character	Stop stress if abnormal status is detected.
COMPliance	character	Stops stress only if some SMU reaches its compliance setting.
OFF	character	Continue stress even if abnormal status is detected.

Query response                        ABN|COMP|OFF <newline><^END>

Example

```
OUTPUT @Hp4155;":PAGE:STR:SET:SST ABN"

OUTPUT @Hp4155;":PAGE:STR:SET:SST?"
ENTER @Hp4155;A$
```

---

## **:PAGE:SYSTEM:CDIagnostic[:MENU]**

This command changes the current display page to :SYSTEM: SELF-CALIBRATION/DIAGNOSTICS page.

This command does not have query form.

Syntax                    **:PAGE:SYSTEM:CDIagnostic [ :MENU ]**

Example                    **OUTPUT @Hp4155; ":PAGE:SYST:CDI"**

---

## **:PAGE:SYSTEM:COLor[:MENU]**

This command changes the current display page to “:SYSTEM: COLOR SETUP” page.

This command does not have query form.

Syntax                    **:PAGE:SYSTEM:COLor [ :MENU ]**

Example                    **OUTPUT @Hp4155; ":PAGE:SYST:COL"**

---

## **:PAGE:SYSTEM:CONFIg[:MENU]**

This command changes the current display page to “:SYSTEM: CONFIGURATION” page.

This command does not have query form.

Syntax                   :PAGE:SYSTem:CONFIg[:MENU]

Example                 OUTPUT @Hp4155;":PAGE:SYST:CONF"

---

### :PAGE:SYSTem:FILEr[:MENU]

This command changes the current display page to “:SYSTEM: FILER” page.  
This command does not have query form.

Syntax                   :PAGE:SYSTem:FILEr[:MENU]

Example                 OUTPUT @Hp4155;":PAGE:SYST:FIL"

---

### :PAGE:SYSTem:MISC[:MENU]

This command changes the current display page to “:SYSTEM: MISCELLANEOUS” page.  
This command does not have query form.

Syntax                   :PAGE:SYSTem:MISC[:MENU]

SCPI Commands  
**PAGE Subsystem**

Example                    `OUTPUT @Hp4155;":PAGE:SYST:MISC"`

---

**:PAGE:SYSTEM:PRINT[:MENU]**

This command changes the current display page to “:SYSTEM: PRINT SETUP” page.

This command does not have query form.

Syntax                    `:PAGE:SYSTEM:PRINT[:MENU]`

Example                    `OUTPUT @Hp4155;":PAGE:SYST:PRIN"`



# PROGram Subsystem

The PROGram subsystem downloads and controls the user-defined HP Instrument BASIC program in an instrument.

The following table is the command tree of PROGram subsystem.

**Table 1-31. PROGram Subsystem**

Command	Parameter
:PROGram	
:CATalog?	
[:SElected]	
:DEFine	<program>
:DElete	
[:SElected]	
:ALL	
:EXECute	
:MALLocate	<nbytes>   DEFault
:NAME	<prog_name>
:NUMBer	<varname> {,<nvalues>}
:STATe	RUN   PAUSE   STOP   CONTinue
:STRing	<varname> {,<svalues>}
:WAIT	

To comply with SCPI, the following EXPLicit subsystem is also implemented for HP 4155A/4156A.

The function of EXPLicit subsystem commands is same as corresponding above commands of :SElected subsystem.

SCPI Commands  
**PROG**ram Subsystem

**Table 1-32. PROG**ram Subsystem

Command	Parameter
:PROG	
:EXPLICIT	
:DEFine	"PROG", <program>
:DELete	"PROG"
:EXECute	"PROG"
:MALLocate	"PROG", <nbytes>   DEFault
:NUMBer	"PROG", <varname> {,<nvalues>}
:STATe	"PROG", RUN   PAUSE   STOP   CONTinue
:STRing	"PROG", <varname> {,<svalues>}
:WAIT	"PROG"

---

## :PROGram:CATalog?

For HP 4155A/4156A, only one program can be downloaded. So, the response of this command is always "PROG".

Syntax	:PROGram:CATalog?
Query response	"PROG" <newline><^END>
Example	OUTPUT @Hp4155;":PROG:CAT?" ENTER @Hp4155;A\$

---

## :PROGram[:SElected]:DEFine

This command is used to create and download a program.

The query form of this command is used to upload a program.

Syntax	:PROGram[:SElected]:DEFine <i>program</i>
--------	---

Parameter

Parameter	Type	Explanation
<i>program</i>	arbitrary block	block data of a program

Query response	<i>program</i> <newline><^END>
----------------	--------------------------------

*program* is uploaded as definite length arbitrary block response data.

SCPI Commands  
**PROGram Subsystem**

Example

```
! Indefinite length example
OUTPUT @Hp4155;":PROG:DEF #0"
OUTPUT @Hp4155;"10 PRINT ""HELLO!""
OUTPUT @Hp4155;"20 END"
OUTPUT @Hp4155;" " END ! Terminator
```

```
! Query example
DIM A$[100000]
OUTPUT @Hp4155;":PROG:DEF?"
ENTER @Hp4155 USING "%,2A";HEAD$
B=VAL(HEAD$[2])
FOR I=1 TO B
  ENTER @Hp4155 USING "%,A";HEAD$
NEXT I
ENTER 717 USING "-K";A$
```

---

### **:PROGram[:SElected]:DELeTe[:SElected]**

This command deletes the downloaded program.

This command does not have query form.

Syntax

```
:PROGram[:SElected]:DELeTe[:SElected]
```

Example

```
OUTPUT @Hp4155;":PROG:DEL"
```

---

### **:PROGram[:SElected]:DELeTe:ALL**

This command deletes the downloaded program.

For HP 4155A/4156A, only one program can be downloaded. Therefore, this command is the same as :PROGram[:SELEcted]:DELEte[:SELEcted].

This command does not have query form.

Syntax                   :PROGram [ :SELEcted ] :DELEte:ALL

Example                 OUTPUT @Hp4155;":PROG:DEL:ALL"

See also                :PROGram[:SELEcted]:DELEte[:SELEcted]

## :PROGram[:SELEcted]:EXECute

This command executes the specified HP Instrument BASIC command for the downloaded program.

The downloaded program must be in either the PAUSEd or STOPped state.

This command does not have query form.

Syntax                   :PROGram [ :SELEcted ] :EXECute *command*

Parameter

Parameter	Type	Explanation
<i>command</i>	string	HP Instrument BASIC command

Example                 OUTPUT @Hp4155;":PROG:EXEC 'STEP' "

---

## :PROGram[:SElected]:MALLocate

This command is not implemented for HP 4155A/4156A. This command is ignored, but does not cause an error.

---

## :PROGram[:SElected]:NAME

This command is not implemented for HP 4155A/4156A. This command is ignored, but does not cause an error.

The query form always returns “PROG” string.

---

## :PROG[:SElected]:NUMBer

This command is used to set or query the contents of numeric variables and arrays in the downloaded program.

The specified variable must be the name of a variable in the downloaded program.

Syntax

:PROG [ :SElected ] :NUMBer *varname* { , *value* }

Parameter

Parameter	Type	Explanation
<i>varname</i>	string or character	name of the numeric variable or array
<i>value</i>	numeric	value to set for specified variable

When *varname* is numeric array, *values* are set from the first element of the array. If the number of *value* is less than number of array elements, the leftover elements are not changed. If the number of *value* is greater than number of array elements, extra *values* are ignored.

Query response            *value* { ,*value* } <newline><^END>  
*value* is NR3 response data type.

Example                    OUTPUT @Hp4155;":PROG:NUMB A,5"  
                               OUTPUT @Hp4155;":PROG:NUMB 'Ab',5,5,5,5,5"  
                               OUTPUT @Hp4155;":PROG:NUMB? A"  
                               ENTER @Hp4155;B  
                               OUTPUT @Hp4155;":PROG:NUMB? 'Ab' "  
                               ENTER @Hp4155;Ab(\*)

## :PROG[:SElected]:STATE

This command is used to set the state or query the state of the downloaded program.

The following table shows the result of setting the STATE for each of the possible current states.

desired state	current state		
	RUNNING	PAUSED	STOPPED
RUN	error  -221	RUNNING	RUNNING
CONT	error  -221	RUNNING	error  -221
PAUSE	PAUSED	PAUSED	STOPPED
STOP	STOPPED	STOPPED	STOPPED

SCPI Commands  
**PROG**ram Subsystem

Syntax                   :PROG [ :SELEcted ] :STATe RUN|PAUSE|STOP|CONTINUE

Query response           RUN|PAUS|STOP <newline><^END>

Example                   OUTPUT @Hp4155;":PROG:STAT RUN"  
  
                           OUTPUT @Hp4155;":PROG:STAT?"  
                           ENTER @Hp4155;A\$

## :PROG[:SELEcted]:STRing

This command is used to set or query the contents of string variables and arrays in the downloaded program.

The specified variable must be an existing variable in the downloaded program.

Syntax                   :PROG [ :SELEcted ] :STRing *varname* { ,*string* }

Parameter

Parameter	Type	Explanation
<i>varname</i>	string or character	name of the string variable or array
<i>string</i>	string	string to set for specified variable

When *varname* is string array, *strings* are set from the first element of the array. If the number of *string* is less than number of array elements, the leftover elements are not changed. If the number of *string* is greater than number of array elements, extra *strings* are ignored.

Query response           *string* { ,*string* } <newline><^END>

*string* is string response data type.



Example            OUTPUT @Hp4155;":PROG:STR Ab,'Voltage'"  
                  OUTPUT @Hp4155;":PROG:STR 'Ab','Voltage','Current'"  
                  OUTPUT @Hp4155;":PROG:STR? A"  
                  ENTER @Hp4155;B\$

---

## :PROG[:SElected]:WAIT

This command stops the execution of commands or queries until the downloaded program exits from the RUN state (that is, until program is STOPped or PAUSed).

Syntax            :PROG [ :SElected ] :WAIT

Query response    1 <newline><^END>

A 1 is returned if the program is either STOPped or PAUSed.

Example            OUTPUT @Hp4155;":PROG:WAIT"  
                  OUTPUT @Hp4155;":PROG:WAIT?"  
                  ENTER @Hp4155;A

---

## STATus Subsystem

The STATus subsystem accesses the non-IEEE488.2 status structures of the HP 4155A/4156A.

These status structures are as follows:

- Operation Status Register (for SCPI)  
Consists of CONDITION, TRANSITION FILTER, EVENT, and event enable (MASK) registers.
- Questionable Status Register (for SCPI)  
Consists of CONDITION, TRANSITION FILTER, EVENT, and event enable (MASK) registers.
- Emergency Status Register (for HP 4155A/4156A)  
Consists of EVENT and event enable (MASK) registers.
- Measure/Stress Status Register (for HP 4155A/4156A)  
Consists of EVENT and event enable (MASK) registers.

Refer to “Status Reporting Structure” for details about these registers and about the status-reporting structure of both non-IEEE488.2 and IEEE488.2 status structures.

Table 1-33 is the command tree of STATus subsystem.

**Table 1-33. STATus Subsystem**

Command	Parameter
:STATus	
:EMERgency	
[:EVENT]?	
:ENABle	<numeric_value>
:MEASurement	
[:EVENT]?	
:ENABle	<numeric_value>
:OPERation	
[:EVENT]?	
:CONDition?	
:ENABle	<numeric_value>
:PTRansition	<numeric_value>
:NTRansition	<numeric_value>
:PRESet	
:QUESTionable	
[:EVENT]?	
:CONDition?	
:ENABle	<numeric_value>
:PTRansition	<numeric_value>
:NTRansition	<numeric_value>

<numeric\_value> can be a decimal integer, hexadecimal, octal, or binary value that is the sum of the binary-weighted values for the desired bits.

SCPI Commands  
**STATus Subsystem**

Register	Bit Status	15	14	13	12	11	10	9	8	7	6	5	4	3	2	1	0
		1	0	1	1	0	1	1	1	1	1	1	0	0	0	0	0
binary		#B10110111111100000															
		10110111111100000															
octal		#Q1 3 3 7 4 0															
		10110111111100000															
hexadecimal	#H	B 7 E 0															
decimal		47072 ← $2^{15}+2^{13}+2^{12}+2^{10}+2^9+2^8+2^7+2^6+2^5$															

PG04009 120X90

---

## :STATus:EMERgency:ENABle

This command sets the event enable (MASK) for the Emergency Status “EVENT” register. 1 enables a bit, and 0 disables a bit.

Enabled “EVENT” bits are ORed together, then reported to Bit0 of the Status Byte Register.

Syntax                               :STATus:EMERgency:ENABle *register*

Parameter

Parameter	Type	Explanation
<i>register</i>	numeric or non-decimal numeric	decimal integer, hexadecimal, octal, or binary value that is the sum of the binary-weighted values for the desired bits.

Query response

*register* <newline><^END>

*register* is a decimal integer value, which is the sum of the binary-weighted values, in NR1 response data format.

Example

```
OUTPUT @Hp4155;":STAT:EMER:ENAB 16384"
OUTPUT @Hp4155;":STAT:EMER:ENAB #H4000"
OUTPUT @Hp4155;":STAT:EMER:ENAB #Q40000"
OUTPUT @Hp4155;":STAT:EMER:ENAB #B100000000000000"

OUTPUT @Hp4155;":STAT:EMER:ENAB?"
ENTER @Hp4155;A
```

---

## :STATus:EMERgency[:EVENT]?

This command returns the present status of the Emergency Status “EVENT” register.

**STATus Subsystem**

Reading this register clears it.

This command has query form *only*.

Syntax                   :STATus:EMERgency [ :EVENT ] ?

Query response           *register* <newline><^END>

*register* is a decimal integer value, which is the sum of the binary-weighted values, in NR1 response data format.

Example                   OUTPUT @Hp4155;":EMER:EMER?"  
ENTER @Hp4155;A

**:STATus:MEASurement:ENABLE**

This command sets the event enable (MASK) for the Measurement/Stress Status "EVENT" register. 1 enables a bit, and 0 disables a bit.

Enabled "EVENT" bits are ORed together, then reported to Bit1 of the Status Byte register.

Syntax                   :STATus:MEASurement:ENABLE *register*

Parameter

Parameter	Type	Explanation
<i>register</i>	numeric or non-decimal numeric	decimal integer, hexadecimal, octal, or binary value that is the sum of the binary-weighted values for the desired bits.

Query response           *register* <newline><^END>

*register* is a decimal integer value, which is the sum of the binary-weighted values, in NR1 response data format.

Example            OUTPUT @Hp4155;":STAT:MEAS:ENAB 15"  
                  OUTPUT @Hp4155;":STAT:MEAS:ENAB #H000F"  
                  OUTPUT @Hp4155;":STAT:MEAS:ENAB #Q00000017"  
                  OUTPUT @Hp4155;":STAT:MEAS:ENAB #B000000000001111"  
  
                  OUTPUT @Hp4155;":STAT:MEAS:ENAB?"  
                  ENTER @Hp4155;A

---

### :STATus:MEASurement[:EVENT]?

This command returns the present status of the Measurement/Stress Status "EVENT" register.

Reading this register clears it.

This command has query form *only*.

Syntax            :STATus:MEASurement [ :EVENT ]?

Query response    *register* <newline><^END>

*register* is a decimal integer value, which is the sum of the binary-weighted values, in NR1 response data format.

Example            OUTPUT @Hp4155;":STAT:MEAS?"  
                  ENTER @Hp4155;A

---

### :STATus:OPERation:CONDition?

This command returns the present status of the Operation Status "CONDITION" register.

**STATus Subsystem**

Reading this register does *not* clear it.

This command has query form *only*.

Syntax                   :STATus:OPERation:CONDition?

Query response         *register* <newline><^END>

*register* is a decimal integer value, which is the sum of the binary-weighted values, in NR1 response data format.

Example                 OUTPUT @Hp4155;":STAT:OPER:COND?"  
ENTER @Hp4155;A

**:STATus:OPERation:ENABLE**

This command sets the event enable (MASK) for the Operation Status "EVENT" register. 1 enables a bit, and 0 disables a bit.

Enabled "EVENT" bits are ORed together, then reported to Bit7 of the Status Byte Register.

Syntax                   :STATus:OPERation:ENABle *register*

Parameter

Parameter	Type	Explanation
<i>register</i>	numeric or non-decimal numeric	decimal integer, hexadecimal, octal, or binary value that is the sum of the binary-weighted values for the desired bits.

Query response         *register* <newline><^END>

*register* is a decimal integer value, which is the sum of the binary-weighted values, in NR1 response data format.



Example            OUTPUT @Hp4155;":STAT:OPER:ENAB 16384"  
                  OUTPUT @Hp4155;":STAT:OPER:ENAB #H4000"  
                  OUTPUT @Hp4155;":STAT:OPER:ENAB #Q40000"  
                  OUTPUT @Hp4155;":STAT:OPER:ENAB #B10000000000000000"  
  
                  OUTPUT @Hp4155;":STAT:OPER:ENAB?"  
                  ENTER @Hp4155;A

---

### :STATus:OPERation[:EVENT]?

This command returns the present status of the Operation Status "EVENT" register.

Reading this register clears it.

This command has query form *only*.

Syntax            :STATus:OPERation[:EVENT]?

Query response    *register* <newline><^END>

*register* is a decimal integer value, which is the sum of the binary-weighted values, in NR1 response data format.

Example            OUTPUT @Hp4155;":STAT:OPER?"  
                  ENTER @Hp4155;A

---

### :STATus:OPERation:NTRansition

This command sets the negative transition filter of the Operation Status "CONDITION" register.

**STATus Subsystem**

Syntax                    :STATus:OPERation:NTRansition *register*

Parameter

Parameter	Type	Explanation
<i>register</i>	numeric or non-decimal numeric	decimal integer, hexadecimal, octal, or binary value that is the sum of the binary-weighted values for the desired bits.

Query response

*register* <newline><^END>

*register* is a decimal integer value, which is the sum of the binary-weighted values, in NR1 response data format.

Semantics

If a bit in the negative transition filter is set to 1, then a 1 to 0 transition in the corresponding bit of the Operation Status "CONDITION" register causes a 1 to be written in the corresponding "EVENT" register.

Example

```
OUTPUT @Hp4155;":STAT:OPER:NTR 16384"
OUTPUT @Hp4155;":STAT:OPER:NTR #H4000"
OUTPUT @Hp4155;":STAT:OPER:NTR #Q40000"
OUTPUT @Hp4155;":STAT:OPER:NTR #B100000000000000"

OUTPUT @Hp4155;":STAT:OPER:NTR?"
ENTER @Hp4155;A
```

---

## :STATus:OPERation:PTRansition

This command sets the positive transition filter for the Operation Status "CONDITION" register.

Syntax

:STATus:OPERation:PTRansition *register*

Parameter

Parameter	Type	Explanation
<i>register</i>	numeric or non-decimal numeric	decimal integer, hexadecimal, octal, or binary value that is the sum of the binary-weighted values for the desired bits.

Query response

*register* <newline><^END>

*register* is a decimal integer value, which is the sum of the binary-weighted values, in NR1 response data format.

Semantics

If a bit in the positive transition filter is set to 1, then a 0 to 1 transition in the corresponding bit of the Operation Status “CONDITION” register causes a 1 to be written in the corresponding “EVENT” register.

Example

```
OUTPUT @Hp4155;":STAT:OPER:PTR 16384"
OUTPUT @Hp4155;":STAT:OPER:PTR #H4000"
OUTPUT @Hp4155;":STAT:OPER:PTR #Q40000"
OUTPUT @Hp4155;":STAT:OPER:PTR #B100000000000000"

OUTPUT @Hp4155;":STAT:OPER:PTR?"
ENTER @Hp4155;A
```

---

## :STATus:PRESet

This command presets the event enable (MASK) register and TRANSITION FILTER registers of the Operation Status, Questionable Status, and Emergency Status registers.

The preset value of each register as follows:

SCPI Commands

**STATus Subsystem**

Register	Filter/Enable	PREset value
OPERation	ENABle	0s
	PTR	1s
	NTR	0s
QUESTionable	ENABle	0s
	PTR	1s
	NTR	0s
EMERgency	ENABle	1s
	PTR	1s
	NTR	0s

This command does not have query form.

Syntax                   :STATus:PRESet

Example                 OUTPUT @Hp4155;" :STAT:PRES"

**:STATus:QUESTionable:CONDition?**

This command returns the present status of the Questionable Status "CONDITION" register.

Reading this register does *not* clear it.

This command has query form *only*.

Syntax                   :STATus:QUESTionable:CONDition?

Query response            *register* <newline><^END>

*register* is a decimal integer value, which is the sum of the binary-weighted values, in NR1 response data format.

Example                    OUTPUT @Hp4155;":STAT:QUES:COND?"  
                               ENTER @Hp4155;A

## :STATus:QUEStionable:ENABle

This command sets the event enable (MASK) for the Questionable Status "EVENT" register. 1 enables a bit, and 0 disables a bit.

Enabled "EVENT" bits are ORed together, then reported to Bit3 of the Status Byte Register.

Syntax                    :STATus:QUEStionable:ENABle *register*

Parameter

Parameter	Type	Explanation
<i>register</i>	numeric or non-decimal numeric	decimal integer, hexadecimal, octal, or binary value that is the sum of the binary-weighted values for the desired bits.

Query response            *register* <newline><^END>

*register* is a decimal integer value, which is the sum of the binary-weighted values, in NR1 response data format.

Example                    OUTPUT @Hp4155;":STAT:QUES:ENAB 16384"  
                               OUTPUT @Hp4155;":STAT:QUES:ENAB #H4000"  
                               OUTPUT @Hp4155;":STAT:QUES:ENAB #Q40000"  
                               OUTPUT @Hp4155;":STAT:QUES:ENAB #B10000000000000000"  
                               OUTPUT @Hp4155;":STAT:QUES:ENAB?"

SCPI Commands  
**STATus Subsystem**

```
ENTER @Hp4155;A
```

---

### :STATus:QUEStionable[:EVENT]?

This command returns the present status of the Questionable Status “EVENT” register.

Reading this register clears it.

This command has query form *only*.

Syntax                   :STATus:QUEStionable[:EVENT]?

Query response           *register* <newline><^END>

*register* is a decimal integer value, which is the sum of the binary-weighted values, in NR1 response data format.

Example                   OUTPUT @Hp4155;":STAT:QUES?"  
                          ENTER @Hp4155;A

---

### :STATus:QUEStionable:NTRansition

This command sets the negative transition filter of the Questionable Status “CONDITION” register.

Syntax                   :STATus:QUEStionable:NTRansition *register*

Parameter

Parameter	Type	Explanation
<i>register</i>	numeric or non-decimal numeric	decimal integer, hexadecimal, octal, or binary value that is the sum of the binary-weighted values for the desired bits.

Query response

*register* <newline><^END>

*register* is a decimal integer value, which is the sum of the binary-weighted values, in NR1 response data format.

Semantics

If a bit in the negative transition filter is set to 1, then a 1 to 0 transition in the corresponding bit of the Questionable Status "CONDITION" register causes a 1 to be written in the corresponding "EVENT" register.

Example

```
OUTPUT @Hp4155;":STAT:QUES:NTR 16384"
OUTPUT @Hp4155;":STAT:QUES:NTR #H4000"
OUTPUT @Hp4155;":STAT:QUES:NTR #Q40000"
OUTPUT @Hp4155;":STAT:QUES:NTR #B1000000000000000"

OUTPUT @Hp4155;":STAT:QUES:NTR?"
ENTER @Hp4155;A
```

---

## :STATus:QUEStionable:PTRansition

This command sets the positive transition filter of the Questionable Status "CONDITION" register.

Syntax

:STATus:QUEStionable:PTRansition *register*

**STATus Subsystem**

Parameter

Parameter	Type	Explanation
<i>register</i>	numeric or non-decimal numeric	decimal integer, hexadecimal, octal, or binary value that is the sum of the binary-weighted values for the desired bits.

Query response

*register* <newline><^END>

*register* is a decimal integer value, which is the sum of the binary-weighted values, in NR1 response data format.

Semantics

If a bit in the positive transition filter is set to 1, then a 0 to 1 transition in the corresponding bit of the Questionable Status "CONDITION" register causes a 1 to be written in the corresponding "EVENT" register.

Example

```
OUTPUT @Hp4155;":STAT:QUES:PTR 16384"
OUTPUT @Hp4155;":STAT:QUES:PTR #H4000"
OUTPUT @Hp4155;":STAT:QUES:PTR #Q40000"
OUTPUT @Hp4155;":STAT:QUES:PTR #B1000000000000000"

OUTPUT @Hp4155;":STAT:QUES:PTR?"
ENTER @Hp4155;A
```



---

## SYSTEM Subsystem

The SYSTEM subsystem is a collection of functions that are not related to instrument performance.

Examples include functions for performing general housekeeping and functions related to setting global configurations, such TIME or LANGUAGE.

The following table is the command tree of SYSTEM subsystem.

SCPI Commands  
**SYSTem Subsystem**

**Table 1-34. SYSTem Subsystem**

Command	Parameter
:SYSTem	
:BEEPer	
:STATe	0   1   OFF   ON
:COMMunicate	
:GPIB	
:RDEvice	
:ADDRes	<numeric_value>
[:SELF]	
:ADDRes	<numeric_value>
:SERial	
[:RECeive]	
:BAUD	<numeric_value>
:PACE	XON   HWIRed   NONE
:PARity	
[:TYPE]	EVEN   ODD   ZERO   ONE   NONE
:SBITs	<numeric_value>
:TRANsmit	
:BAUD	<numeric_value>
:PACE	XON   HWIRed
:PARity	
[:TYPE]	EVEN   ODD   ZERO   ONE   NONE
:SBITs	<numeric_value>
:DATE	<year>,<month>,<day>
:ERRor?	
:LANGuage	COMPAtibility
:LFRequency	<numeric_value>
:TIME	<hour>,<minute>,<second>
:VERSion?	

## :SYSTem:BEEPer:STATe

This command controls whether the beeper is enabled.

At \*RST, this value is ON.

Syntax                   :SYSTem:BEEPer:STATe OFF|ON|0|1

Parameter

Parameter	Type	Explanation
OFF or 0	boolean	beeper is disabled
ON or 1	boolean	beeper is enabled

Query response           0|1 <newline><^END>

Example

```
OUTPUT @Hp4155;":SYST:BEEP:STAT ON"

OUTPUT @Hp4155;":SYST:BEEP:STAT?"
ENTER @Hp4155;A
```

## :SYSTem:COMMunicate:GPIB:RDEvice:ADDRESS

This command sets the HP-IB bus address of hard copy.

This command does not affect the address of the peripheral device.

HP 4155A/4156A sends hard copy data to the device which has specified HP-IB bus address.

At \*RST, the value of this parameter is 1.

SCPI Commands

**SYSTem Subsystem**

Syntax                   :SYSTem:COMMunicate:GPIB:RDEvice:ADDRess  
*address* | MINimum | MAXimum

Parameter

Parameter	Type	Explanation
<i>address</i>	numeric	0 to 30

Query response

*address* <newline><^END>  
*address* is NR1 response data.

Example

```
OUTPUT @Hp4155;" :SYST:COMM:GPIB:RDEV:ADDR 1"  
  
OUTPUT @Hp4155;" :SYST:COMM:GPIB:RDEV:ADDR?"  
ENTER @Hp4155;A
```

---

**:SYSTem:COMMunicate:GPIB[:SELF]:ADDRess**

This command sets the HP-IB address of the HP 4155A/4156A itself.

\*RST has no effect on the value of this parameter.

Syntax                   :SYSTem:COMMunicate:GPIB [ :SELF ] :ADDRess  
*address* | MINimum | MAXimum

Parameter

Parameter	Type	Explanation
<i>address</i>	numeric	0 to 30

Query response

*address* <newline><^END>  
*address* is NR1 response data.

Example                    `OUTPUT @Hp4155;":SYST:COMM:GPIB:ADDR 17"`  
                           `OUTPUT @Hp4155;":SYST:COMM:GPIB:ADDR?"`  
                           `ENTER @Hp4155;A`

---

## `:SYSTem:COMMunicate:SERial[:RECeive]:BAUD`

This command sets the baud rate associated with reception.

This parameter is coupled to `TRANsmit:BAUD`, so both are set to same value.

\*RST has no effect on the value of this parameter.

Syntax                    `:SYSTem:COMMunicate:SERial[:RECeive]:BAUD`  
                           `baud_rate|MINimum|MAXimum`

If you set 38400, you can transmit only. Not receive.

Parameter

Parameter	Type	Explanation
<i>baud_rate</i>	numeric	600, 1200, 2400, 4800, 9600, 19200

Query response            `baud_rate <newline><^END>`

*baud\_rate* is NR1 response data.

Example                    `OUTPUT @Hp4155;":SYST:COMM:SER:BAUD 2400"`  
                           `OUTPUT @Hp4155;":SYST:COMM:SER:BAUD?"`  
                           `ENTER @Hp4155;A`

**SYSTem Subsystem**

See also `SYSTem:COMMunicate:SERial:TRANsmit:BAUD`

---

## **:SYSTem:COMMunicate:SERial[:RECeive]:PACE**

This command sets the software pacing mode for reception.

\*RST has no effect on the value of this parameter.

Syntax `:SYSTem:COMMunicate:SERial[:RECeive]:PACE XON|HWIRed|NONE`

Parameter

Parameter	Type	Explanation
XON	character	Xon-Xoff handshake
HWIRed	character	Hard wired handshake
NONE	character	

Query response `XON|HWIR|NONE <newline><^END>`

Example `OUTPUT @Hp4155;":SYST:COMM:SER:PACE XON"`

`OUTPUT @Hp4155;":SYST:COMM:SER:PACE?"`

`ENTER @Hp4155;A`

---

## **:SYSTem:COMMunicate:SERial[:RECeive]:PARity[:TYPE]**

This command sets the parity type for reception.

This parameter is coupled to `TRANsmit:PARity:TYPE`, so both are set to same type.

\*RST has no effect on the value of this parameter.

Syntax                   :SYSTem:COMMunicate:SERial[:RECEive]:PARity[:TYPE]  
 EVEN|ODD|ZERO|ONE|NONE

Parameter

Parameter	Type	Explanation
EVEN or ZERO	character	Even parity
ODD or ONE	character	Odd parity
NONE	character	none

Query response       EVEN|ODD|NONE <newline><^END>

Example               OUTPUT @Hp4155;":SYST:COMM:SER:PAR EVEN"  
  
 OUTPUT @Hp4155;":SYST:COMM:SER:PAR?"  
 ENTER @Hp4155;A\$

See also              SYSTem:COMMunicate:SERial:TRANsmit:PARity[:TYPE]

## :SYSTem:COMMunicate:SERial[:RECEive]:SBITs

This command sets the number of stop bits for reception.

This parameter is coupled to **TRANsmit:SBIT**, so both are set to same value.

\*RST has no effect on the value of this parameter.

Syntax                   :SYSTem:COMMunicate:SERial[:RECEive]:SBITs  
*num\_bit*|MINimum|MAXimum

**SYSTem Subsystem**

Parameter

Parameter	Type	Explanation
<i>num_bit</i>	numeric	number of stop bits 1 to 2

*num\_bit* = 2 is valid only when the  
SYSTem:COMMunicate:SERial:RECeive:PARity:TYPE is NONE.

Query response

```
num_bit <newline><^END>
```

*num\_bit* is NR1 response data.

Example

```
OUTPUT @Hp4155;":SYST:COMM:SER:SBIT 1"
```

```
OUTPUT @Hp4155;":SYST:COMM:SER:SBIT?"  
ENTER @Hp4155;A
```

See also

SYSTem:COMMunicate:SERial:TRANsmit:SBITs

**:SYSTem:COMMunicate:SERial:TRANsmit:BAUD**

This command sets the baud rate for transmission.

This parameter is coupled to RECeive:BAUD, so both are set to the same value.

\*RST has no effect on the value of this parameter.

Syntax

```
:SYSTem:COMMunicate:SERial:TRANsmit:BAUD  
baud_rate|MINimum|MAXimum
```



Parameter

Parameter	Type	Explanation
<i>baud_rate</i>	numeric	600, 1200, 2400, 4800, 9600, 19200, 38400

Query response

*baud\_rate* <newline><^END>  
*baud\_rate* is NR1 response data.

Example

```
OUTPUT @Hp4155;":SYST:COMM:SER:TRAN:BAUD 2400"
OUTPUT @Hp4155;":SYST:COMM:SER:TRAN:BAUD?"
ENTER @Hp4155;A
```

See also

SYSTem:COMMunicate:SERial[:RECeive]:BAUD

## :SYSTem:COMMunicate:SERial:TRANsmit:PACE

This command sets the software pacing mode for transmission.

\*RST has no effect on the value of this parameter.

Syntax

```
:SYSTem:COMMunicate:SERial:TRANsmit:PACE XON|HWIRed
```

Parameter

Parameter	Type	Explanation
XON	character	Xon-Xoff handshake
HWIRed	character	Hardwired handshake

Query response

```
XON|HWIR|NONE <newline><^END>
```

SCPI Commands  
**SYSTem Subsystem**

Example                    `OUTPUT @Hp4155;":SYST:COMM:SER:TRAN:PACE XON"`  
  
`OUTPUT @Hp4155;":SYST:COMM:SER:TRAN:PACE?"`  
`ENTER @Hp4155;A`

---

**:SYSTem:COMMunicate:SERial:TRANsmit:PARity**  
**[ :TYPE ]**

This command sets the parity type for transmission.

This parameter is coupled to `RECeive:PARity:TYPE`, so both are set to the same type.

\*RST has no effect on the value of this parameter.

Syntax                    `:SYSTem:COMMunicate:SERial:TRANsmit:PARity [ :TYPE ]`  
`EVEN | ODD | ZERO | ONE | NONE`

Parameter

Parameter	Type	Explanation
EVEN or ZERO	character	Even parity
ODD or ONE	character	Odd parity
NONE	character	none

Query response            `EVEN | ODD | NONE <newline><^END>`

Example                    `OUTPUT @Hp4155;":SYST:COMM:SER:TRAN:PAR EVEN"`  
  
`OUTPUT @Hp4155;":SYST:COMM:SER:TRAN:PAR?"`  
`ENTER @Hp4155;A$`

See also `SYSTem:COMMunicate:SERial[:RECEive]:PARity[:TYPE]`

---

## `:SYSTem:COMMunicate:SERial:TRANsmit:SBITs`

This command sets the number of stop bits for transmission.

This parameter is coupled to `RECEive:SBIT`, so both are set to the same value.

\*RST has no effect on the value of this parameter.

Syntax `:SYSTem:COMMunicate:SERial:TRANsmit:SBITs`  
`num_bit|MINimum|MAXimum`

Parameter

Parameter	Type	Explanation
<i>num_bit</i>	numeric	number of stop bits 1 to 2

*num\_bit* = 2 is valid only when the `SYSTem:COMMunicate:SERial:TRANsmit:PARity:TYPE` is **NONE**.

Query response `num_bit <newline><^END>`

*num\_bit* is NR1 response data.

Example `OUTPUT @Hp4155;":SYST:COMM:SER:TRAN:SBIT 1"`

```
OUTPUT @Hp4155;":SYST:COMM:SER:TRAN:SBIT?"
ENTER @Hp4155;A
```

**SYSTem Subsystem**

See also `SYSTem:COMMunicate:SERial[:RECEive]:SBITs`

**:SYSTem:DATE**

This command sets the calendar.

\*RST has no effect on the value of this parameter.

Syntax `:SYSTem:DATE year|MINimum|MAXimum, month|MINimum|MAXimum, day|MINimum|MAXimum`

Parameter

Parameter	Type	Explanation
<i>year</i>	numeric	1900 to 2099
<i>month</i>	numeric	1 to 12
<i>day</i>	numeric	1 to 31

Query response `year, month, day <newline><^END>`

*year, month, and day* are NR1 response data.

Example `OUTPUT @Hp4155;":SYST:DATE 1993,1,1"`

`OUTPUT @Hp4155;":SYST:DATE?"`

`ENTER @Hp4155;A,B,C`

**:SYSTem:ERRor?**

This command reads the error from the head of the error queue and removes that error from the queue.

This command has query form *only*.

Syntax                   :SYSTem:ERRor?

Query response           *err\_no, message* <newline><^END>

*err\_no* is numeric response data, and *message* is string response data..

If there has been no error (error queue is empty), the response to this query command is as follows:

0, "No error"

Example                   OUTPUT @Hp4155;":SYST:ERR?"  
ENTER @Hp4155;A,\$B

## :SYSTem:LANGUage

This command performs reset, then switches the remote command language from HP 4155/56 (SCPI) to HP 4145B syntax commands mode.

After switching the language to HP 4145B syntax commands mode, only the "\*RST" command can switch the language back to SCPI mode.

This command does not have query form.

At \*RST, the remote command language is SCPI.

Syntax                   :SYSTem:LANGUage COMPatibility

Parameter

Parameter	Type	Explanation
COMPatibility	character	HP 4145B syntax commands

**SYSTem Subsystem**

Example                    `OUTPUT @Hp4155;":SYST:LANG COMP"`

**:SYSTem:LFRrequency**

This command sets or queries the value that is set for the power line frequency (reference frequency).

At \*RST, the value of this parameter is 50 Hz.

Syntax                    `:SYSTem:LFRrequency frequency`

Parameter

Parameter	Type	Explanation
<i>frequency</i>	numeric	50 or 60 [Hz]

''HZ'' suffix can be used after *frequency*.

Query response            `frequency <newline><^END>`

*frequency* is NR3 response data.

Example                    `OUTPUT @Hp4155;":SYST:LFR 50"`

`OUTPUT @Hp4155;":SYST:LFR 50HZ"`

**:SYSTem:TIME**

This command sets the clock.

\*RST has no effect on the value of this parameter.

Syntax                   :SYSTem:TIME *hour*|MINimum|MAXimum, *minute*|MINimum|MAXimum,  
*second*|MINimum|MAXimum

Parameter

Parameter	Type	Explanation
<i>hour</i>	numeric	0 to 23
<i>minute</i>	numeric	0 to 59
<i>second</i>	numeric	0 to 60

Query response

*hour*, *minute*, *second* <newline><^END>  
*hour*, *minute*, and *second* are NR1 response data.

Example

```
OUTPUT @Hp4155;":SYST:TIME 10,5,8"

OUTPUT @Hp4155;":SYST:TIME?"
ENTER @Hp4155;A,B,C
```

## :SYSTem:VERSion?

This command returns the SCPI version number for which the current HP 4155A/4156A complies.

This command has query form *only*.

Syntax

:SYSTem:VERSion?

Query response

*YYYY.V* <newline><^END>  
*YYYY.V* is string response data, but does not contain double quote at beginning and end of the string.  
*YYYY* is the year-version (for example 1993), and *V* is the approved revision number for that year.  
If no approved revisions are claimed, then this extension is 0.

SCPI Commands

**SYSTem Subsystem**

Example

```
OUTPUT @Hp4155;":SYST:VERS?"  
ENTER @Hp4155;A$
```



---

## Common Commands

This section describes common commands and queries of *IEEE 488.2*.

The following table shows some common commands that are supported for the HP 4155A/4156A.

**Table 1-35. Common Commands**

<b>Mnemonic</b>	<b>Name</b>
*CAL?	Calibration Query
*CLS	Clear Status
*ESE ?	Standard Event Status Enable Command  Query
*ESR?	Standard Event Status Register Query
*IDN?	Identification Query
*OPC ?	Operation Complete Command  Query
*OPT?	Option Identification Query
*PCB	Pass Control Back Command
*RST	Reset Command
*SRE ?	Service Request Enable Command  Query
*STB?	Read Status Byte Query
*TRG	Trigger Command
*TST?	Self-Test Query
*WAI	Wait-to-Continue Command

SCPI Commands  
**Common Commands**

---

### **\*CAL?**

This query command performs a full calibration of the instrument, then returns a <numeric\_value> to indicate the calibration result.

Query response

*error\_no* <newline><^END>

<i>error_no</i>	Explanation
0	PASS
1	FAIL

Response data type is NR1.

Example

```
OUTPUT @Hp4155;":CAL?"  
ENTER @Hp4155;A
```

---

### **\*CLS**

This command clears the status data structures and the request for the Operation Complete flag.

Refer to “\*OPC” about the Operation Complete flag.

This command does not have query form.

Syntax

**\*CLS**

Example                    `OUTPUT @Hp4155;"*CLS"`

## \*ESE

This command sets the bits of the Standard Event Status “Enable” Register. 1 enables, 0 masks.

Syntax                    `*ESE mask_number`

Parameter

Parameter	Type	Explanation
<i>mask_number</i>	decimal or non-decimal numeric	numeric value that is the sum of the binary-weighted values for the desired bits

Query response            `mask_number <newline><^END>`

*mask\_number* is decimal numeric value that is the sum of the binary-weighted values for each bits. Response data type is NR1.

Semantics

The Standard Event Status “Enable” Register determines which bits of the Standard Event Status Register are enabled. Enabled bits are ORed together, and the result is reported to bit5 of the Status Byte Register.

The Standard Event Status “Enable” Register consists of 16 bits, but only the lower 8 bits are used, which correspond to the bits of the Standard Event Status Register.

Refer to “Status Reporting Structure” for details about the Standard Event Status “Enable” Register operation.

You can send a *mask\_number* parameter in decimal numeric or non-decimal numeric type.

The following table shows the bits of the Standard Event Status Register and binary-weighted decimal value.

SCPI Commands  
**Common Commands**

bit	binary-weight	description
0	1	OPC (Operation Complete)
1	2	RQC (Request Control)
2	4	QYE (Query ERROR)
3	8	DDE (Device-Dependent ERROR)
4	16	EXE (Execution ERROR)
5	32	CME (Command ERROR)
6	64	NOT USED
7	128	PON (Power on)

Example

The following four lines enable the same bit (CME bit):

```
OUTPUT @Hp4155;"*ESE 32"           using decimal numeric
OUTPUT @Hp4155;"*ESE #B100000"    using binary numeric
OUTPUT @Hp4155;"*ESE #Q40"        using octal numeric
OUTPUT @Hp4155;"*ESE #H20"        using hexadecimal numeric
```

The following is example for query:

```
OUTPUT @Hp4155;"*ESE?"
ENTER @Hp4155;A
```

---

## \*ESR?

This query command returns the present contents of the Standard Event Status Register.

Syntax

```
*ESR?
```

Query response

*register* <newline><^END>

Parameter	Type	Explanation
<i>register</i>	NR1	0 to 255  decimal integer value that is the sum of the binary-weighted values for the set bits

Semantics

The following table shows the bits of the Standard Event Status Register. Refer to “Status Reporting Structure” for details about the register.

bit	binary-weight	description
0	1	OPC  Operation Complete
1	2	RQC  Request Control
2	4	QYE  Query ERROR
3	8	DDE  Device-Dependent ERROR
4	16	EXE  Execution ERROR
5	32	CME  Command ERROR
6	64	URQ NOT USED
7	128	PON  Power on

Example

```
OUTPUT @Hp4155;"*ESR?"
ENTER @Hp4155;A
```

---

### \*IDN?

This query command returns the ID of your HP 4155A/4156A.

SCPI Commands

**Common Commands**

Syntax                    \*IDN?

Query response           HEWLETT-PACKARD,*model*,0,*revision* <newline><^END>

Response	Type	Explanation
<i>model</i>	character	4155A or 4156A
<i>revision</i>	character	HOST CPU:SMUC CPU:AD

Example

```
DIM A$ [50]
OUTPUT @Hp4155;"*IDN?"
ENTER @Hp4155;A$
PRINT A$
```

An example result of above program is:

```
HEWLETT-PACKARD,4155A,0,01.00:01.00:01.00
```

---

**\*OPC**

This command sets the request for the Operation Complete flag, which means the following occurs after this command is executed.

When the operations initiated by the following commands are finished, the OPC bit in the Standard Event Status Register is set:

- :PAGE:SCONtrol[:MEASurement]:SINGle
- :PAGE:SCONtrol[:MEASurement]:APPend
- :PAGE:SCONtrol:STRes[s]:STARt]
- :PAGE:SCONtrol:KSWeep[:STARt]
- :DIAGnostic:TEST[:EXECute]
- :HCOPY[:IMMediate]
- :HCOPY:ITEM:ALL[:IMMediate]
- :HCOPY:ITEM[:WINDow]:TRACe[:IMMediate]
- :HCOPY:SDUMp[:IMMediate]

Syntax                   \*OPC

Query response           1 <newline><^END>

The query returns 1 when all pending device operations are finished.

Example                   OUTPUT @Hp4155;"\*OPC"  
  
                          OUTPUT @Hp4155;"\*OPC?"  
                          ENTER @Hp4155;A

---

### \*OPT?

This query command returns the reportable device options, which are the units in the expander.

Syntax                   \*OPT?

Query response           0|GNDU, 0|SMU5, 0|SMU6, 0|PGU <newline><^END>

Example                   DIM A\$[20]  
                          OUTPUT @Hp4155;"\*OPT?"  
                          ENTER @Hp4155;A\$

---

### \*PCB

This command is used to tell a potential controller which address should be used when passing control back.

This command does not have query form.

SCPI Commands  
**Common Commands**

Syntax                    **\*PCB** *address* { ,*second\_address* }

Parameter

Parameter	Type	Explanation
<i>address</i>	numeric	0 to 30
<i>second_address</i>	numeric	0 to 30

---

**\*RST**

This command performs an instrument reset.

Syntax                    **\*RST**

---

**\*SRE**

This command sets the Service Request “Enable” Register bits.  
1 enables, 0 masks.

Syntax                    **\*SRE** *mask number*

Parameter

Parameter	Type	Explanation
<i>mask_number</i>	decimal or non-decimal numeric	numeric value that is the sum of the binary-weighted values for the desired bits



Query response `mask_number <newline><^END>`

`mask_number` is decimal numeric value that is the sum of the binary-weighted values for each bits. Response data type is NR1.

Semantics

The Service Request “Enable” Register determines which bits of the Status Byte Register are enabled. Enabled bits are ORed together, and the result is reported to the Master Summary Status.

The Service Request “Enable” Register consists of 8 bits: Bit0 to Bit7. Bit6 is not defined, and is always 0.

Refer to “Status Reporting Structure” for details about the Service Request “Enable” Register.

You can send a `mask_number` parameter in decimal numeric or non-decimal numeric type.

The following table shows the bits of the Status Byte Register.

bit	binary-weight	description
0	1	EMERgency Status
1	2	Measurement/Stress Status
2	4	NOT USED
3	8	QUEStionable Status
4	16	MAV  Message Available summary-message
5	32	ESB  Event Status Bit
6	64	MSS  Master Summary Status
7	128	OPERation Status

Example

The following following four lines enable the same bits (bit 7, 4, 1):

```

OUTPUT @Hp4155;"*SRE 146"           using decimal numeric
OUTPUT @Hp4155;"*SRE #B10010010"   using binary numeric
OUTPUT @Hp4155;"*SRE #Q222"       using octal numeric
OUTPUT @Hp4155;"*SRE #H92"        using hexadecimal numeric

```

**Common Commands**

The following is example for query:

```
OUTPUT @Hp4155;"*SRE?"
ENTER @Hp4155;A
```

---

**\*STB?**

This query command reads the Status Byte Register (reads Master Summary Status bit, not Request for Service Message).

Syntax

**\*STB?**

Query response

*register* <newline><^END>

Parameter	Type	Explanation
<i>register</i>	NR1	0 to 255 [decimal integer value that is the sum of the binary-weighted values for the set bits]

Semantics

The following table shows the bits of the Status Byte Register.

bit	binary-weight	description
0	1	EMERgency Status
1	2	Measurement/Stress Status
2	4	NOT USED
3	8	QUEStionable Status
4	16	MAV  Message Available summary-message
5	32	ESB  Event Status Bit
6	64	MSS  Master Summary Status
7	128	OPERation Status

Example                    `OUTPUT @Hp4155;"*STB?"`  
                              `ENTER @Hp4155;A`

---

### \*TRG

This command causes the following action depending on present display page.

- If the present display page is the Stress Group page (STRESS CHANNEL DEFINITION, STRESS SETUP or STRESS FORCE), this command starts the stress force operation.

This action is as same as `PAGE:SCONtrol:STress[:STArT]` command.

- If the present display page is KNOB SWEEP page, this command generates error "Init ignored"(-213).
- If the present display page is not the Stress Group page or KNOB SWEEP page, this command starts the single measurement operation.

This action is as same as `PAGE:SCONtrol[:MEASurement]:SINGLE` command.

SCPI Commands

**Common Commands**

If this command is received while the HP 4155A/4156A is in the measurement or stress state, this command generates error "Init ignored"(-213).

Syntax                    **\*TRG**

---

**\*TST?**

This query command executes an internal self-test, then returns the result.

Syntax                    **\*TST?**

Query response            *pass/fail\_code* <newline><^END>

<i>pass/fail code</i>	<b>Explanation</b>
0	pass
1	fail

Example                    OUTPUT @Hp4155;"\*TST?"  
ENTER @Hp4155;A

---

**\*WAI**

This command stops the execution of any commands or queries until the Operation Complete flag is set. Refer to \*OPC.

Syntax                    **\*WAI**

Example                    OUTPUT @Hp4155;"\*WAI"

---

## Functional Syntax Conventions

Functional syntax is required to create program messages that are transmitted to a HP 4155A/4156A.

---

### Program Message Syntax

Program messages are composed of sequences of commands.

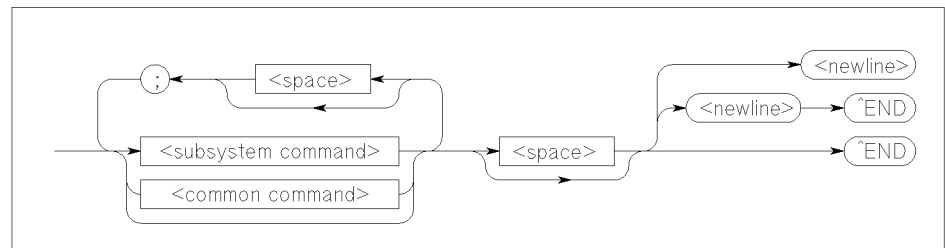

pg04011 120x40

**Figure 1-1. Program Message Syntax**

Figure 1-1 shows the syntax of a program message.

You can send multiple commands in the same message by separating them with a semicolon. Refer to the following example:

To terminate a program message, use one of the three program message terminators, which are <newline>, <^END>, or <newline><^END>.

<^END> means that EOI is asserted on the HP-IB interface at the same time the last data byte is sent.

**Functional Syntax Conventions**

**Subsystem Command Syntax.**

Figure 1-2 shows the syntax of subsystem commands:

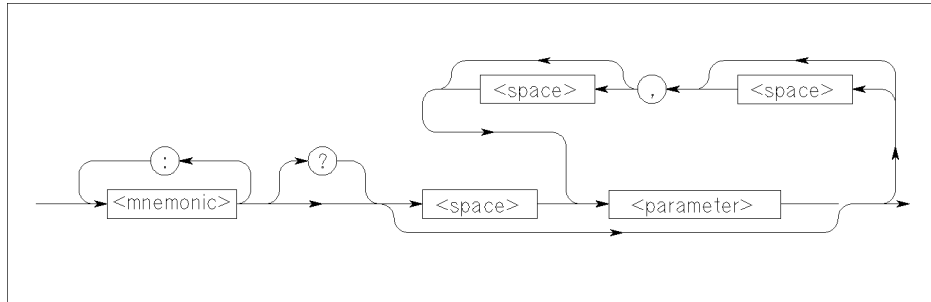

pg040012 120x50

**Figure 1-2. Subsystem Command Syntax**

Query requires ? at the end of the command header.

Many command <mnemonic>s have both long and a short form. For example, CHAN is the short form and CHANNELS is the long form of CHANnelS.

Command <mnemonic> is *not* case sensitive, so ChAnNeLs is just as valid as CHANNELS.

**Common Command Syntax.**

Figure 1-3 shows the syntax of common commands:

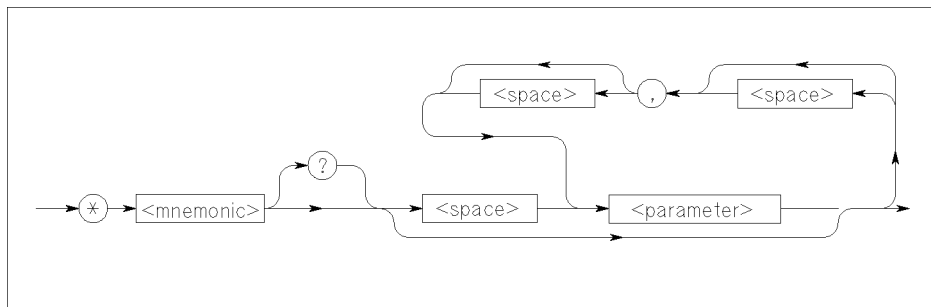

pg04031 120x50

**Figure 1-3. Common Command Syntax**

Query requires ? at the end of the command header.

Command <mnemonic> is *not* case sensitive.

---

## Parameter Types

The following data types of command parameters are available:

- (Decimal) Numeric
- String
- Character
- Arbitrary Block
- Non-decimal Numeric
- Boolean

### (Decimal) Numeric Parameter.

A (decimal) numeric parameter type is decimal data including optional signs, decimal points, and scientific notation defined as follows:

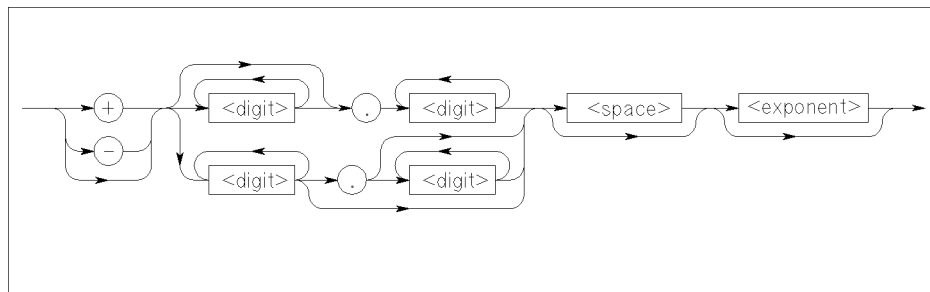

pg040013 120x40

Figure 1-4. (Decimal) Numeric Parameter

**Functional Syntax Conventions**

where <exponent> is defined as follows:

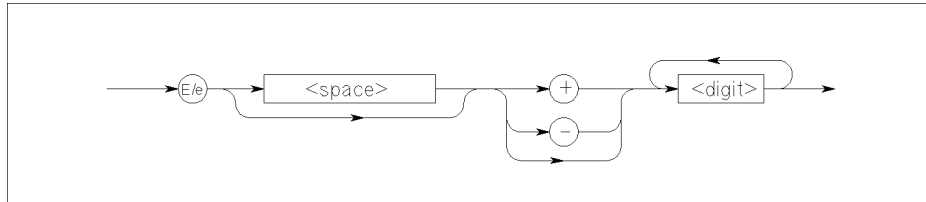

pg040014 120x30

The following shows example numeric parameters that pass the same value:

```

:PAGE:MEAS:CONS:SMU1 123
:PAGE:MEAS:CONS:SMU1 +123.
:PAGE:MEAS:CONS:SMU1 1.23e 100
:PAGE:MEAS:CONS:SMU1 1.23E+100
  
```

For some numeric parameters, you can use the following character parameters to specify the minimum or maximum allowable value:

**MINimum**            minimum allowable value.

**MAXimum**            maximum allowable value.

For commands that allow **MIN** or **MAX** parameter, you can use **MIN** or **MAX** to query the minimum or maximum allowable value.

Refer to the following examples:

```

:PAGE:MEAS:CONS:SMU1 MAX     specify the maximum allowable value
:PAGE:MEAS:CONS:SMU1? MAX    query the maximum allowable value
  
```



**String Parameter.**

A string parameter type is defined as follows:

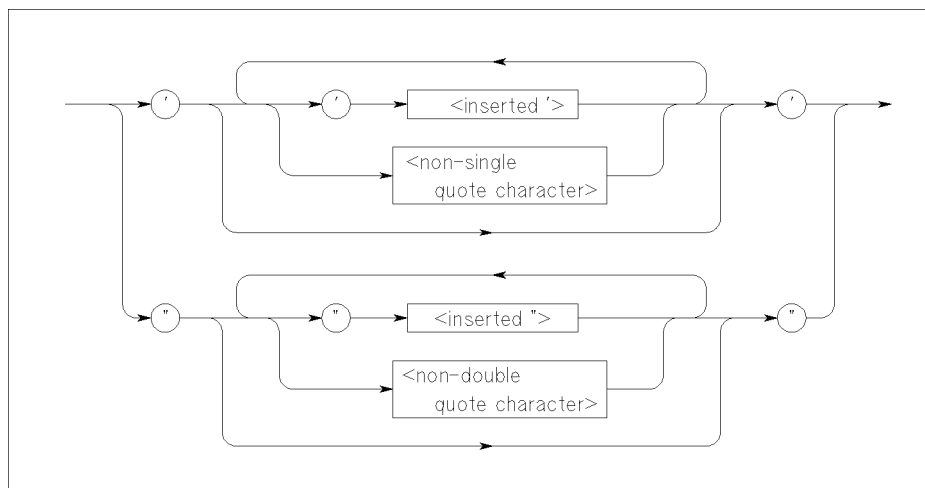

pg040015 120x70

**Figure 1-5. String Parameter**

<inserted'> or <inserted"> means when you want to actually use ' or " in the string. For example, for the string don't, you must enter 'don't'.

String parameter is case sensitive.

Refer to the following examples:

<code>:PAGE:CHAN:COMM 'This is the example'</code>	<i>specifies string:</i> This is the example
<code>:PAGE:CHAN:COMM 'This is the ""example""'</code>	<i>specifies string:</i> This is the "example"

**Functional Syntax Conventions****Character Parameter.**

A character parameter type is for command parameters that have a specific number of allowed settings. For example, the allowed parameters for PAGE:CHAN:CDEF:MODE command are **SWEep** and **SAMPling**.



pg040016 120x30

**Figure 1-6. Character Parameter**

Many <program mnemonic>s have a long form and a short form. For example, you can use **SWE** as short form of **SWEEP**.

<program mnemonic> is *not* case sensitive. For example, the following have the same meaning:

```
:PAGE:CHAN:MODE SWEEP  
:PAGE:CHAN:MODE Sweep
```

**Arbitrary Block Parameter.**

An arbitrary block parameter type is used for binary data transmission and defined as follows:

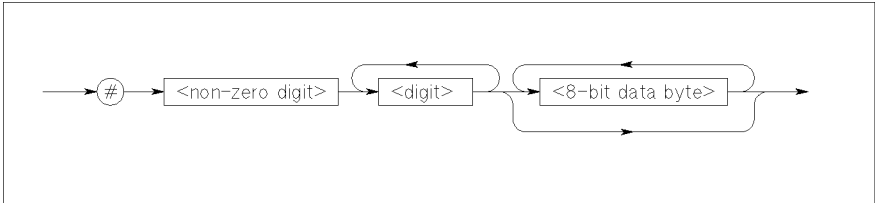

pg04029 120x30

**Figure 1-7. Definite Length Arbitrary Block Parameter**

The single decimal digit <non-zero digit> specifies how many <digit>s will follow. The decimal number <digit>s specifies how many <8-bit data byte>s will follow.

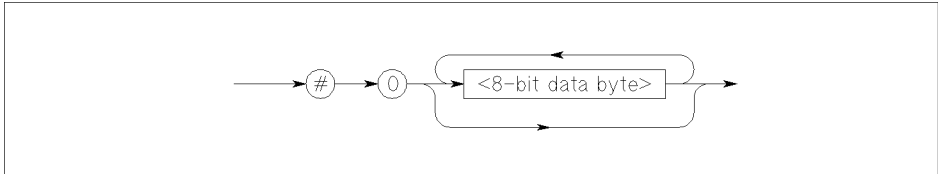

pg04030 120x30

**Figure 1-8. Indefinite Length Arbitrary Block Parameter**

For indefinite length data, use zero 0 digit as shown above.

**Functional Syntax Conventions**

**Non-decimal Numeric Parameter.**

A non-decimal numeric parameter type allows passing numeric information other than decimal (base 10) numeric data.

There are three types of non-decimal numeric parameters:

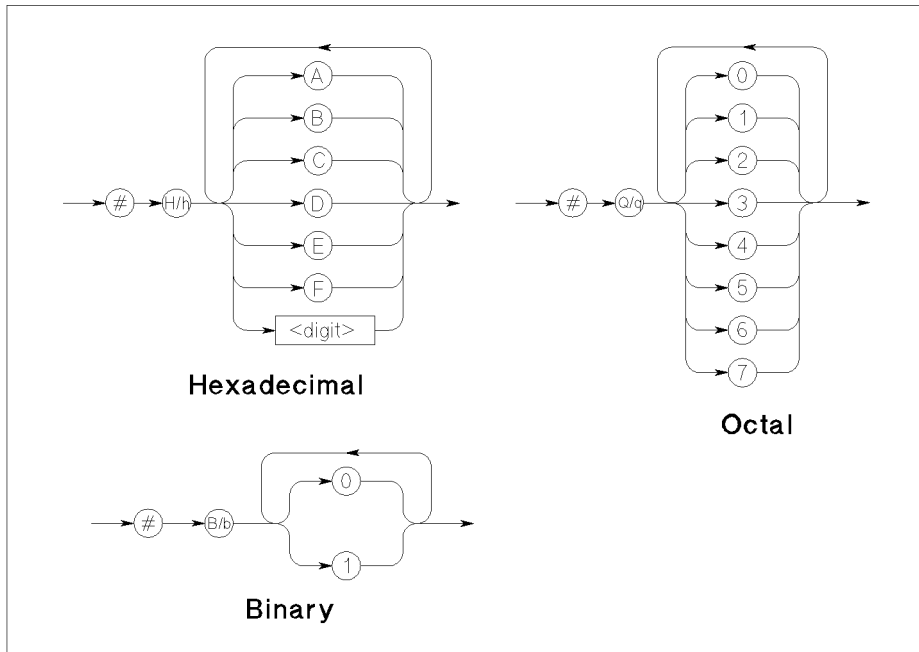

pg040018 120x110

**Figure 1-9. Non-decimal Numeric Parameter**

**Boolean Parameter.**

A boolean parameter type represents a single binary condition that is either true or false and is defined as follows:

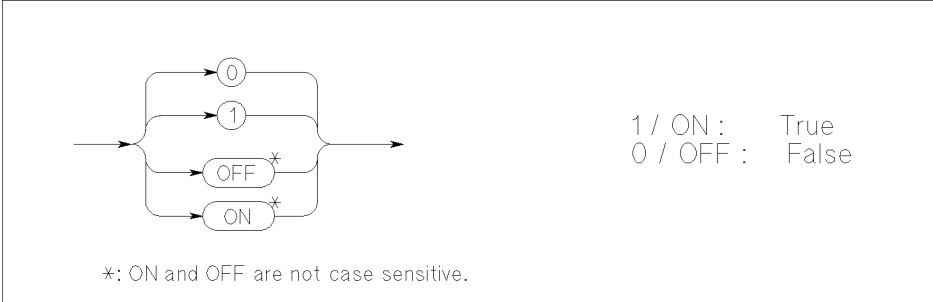

pg04032 120x50

**Figure 1-10. Boolean Parameter**

---

## Response Message Syntax

Figure 1-11 shows the syntax for response messages.

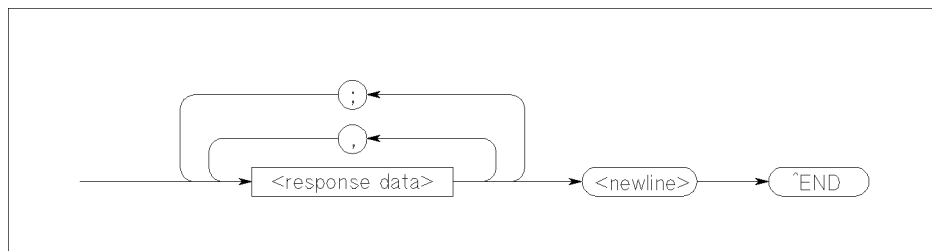

pg040019 120x40

**Figure 1-11. Response Message Syntax**

Response messages may contain both commas and semicolons as separators. When a single query command returns multiple values, a comma is used to separate each data item. When multiple queries are sent in the same message, the groups of data items corresponding to each query are separated by a semicolon.

<newline><^END> is always sent as a response message terminator.

---

## Response Data Types

A <response data> can be the following data types:

- NR1 numeric response data
- NR2 numeric response data
- NR3 numeric response data
- Hexadecimal numeric response data
- Octal numeric response data
- Binary numeric response data
- String response data
- Character response data
- Definite length arbitrary block response data
- Indefinite length arbitrary block response data

**Response Message Syntax**

**NR1 Numeric Response Data.**

An NR1 numeric response data is decimal data defined as follows:

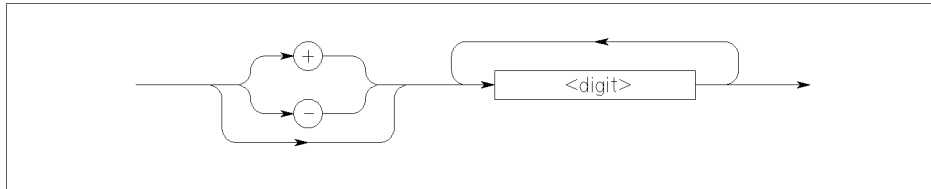

pg040020 120x30

**Figure 1-12. NR1 Numeric Response Data**

**NR2 numeric response data.**

An NR2 numeric response data is decimal data defined as follows:

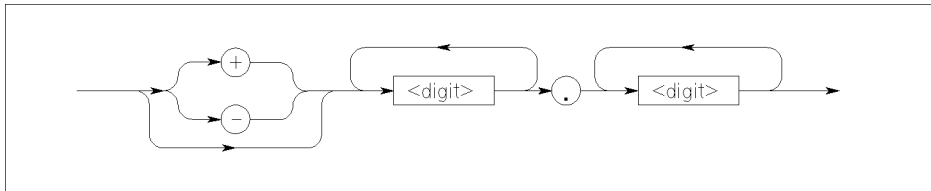

pg040021 120x30

**Figure 1-13. NR2 Numeric Response Data**

**NR3 Numeric Response Data.**

An NR3 numeric response data is decimal data defined as follows:



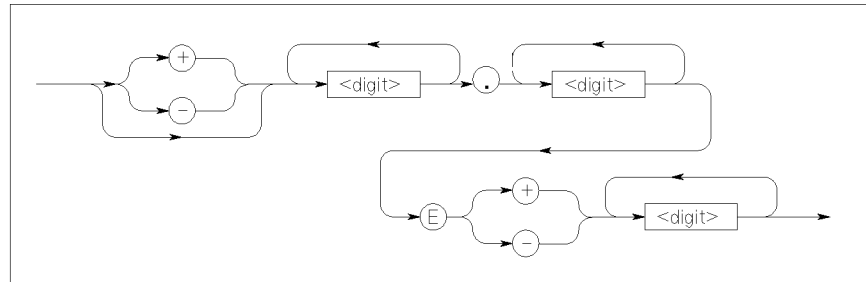

pg040022 120x40

**Figure 1-14. NR3 numeric response data**

**Hexadecimal Numeric Response Data.**

A hexadecimal numeric response data is defined as follows:

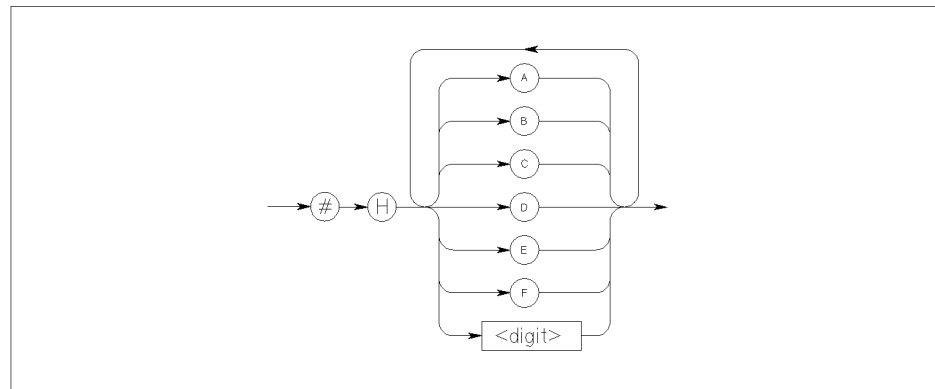

pg040023 120x60

**Figure 1-15. Hexadecimal Numeric Response Data**

**Response Message Syntax**

**Octal Numeric Response Data.**

An octal numeric response data is defined as follows:

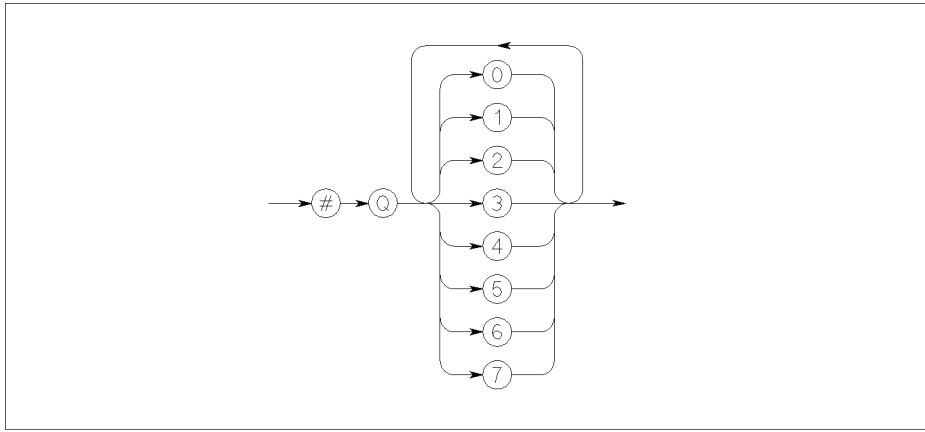

pg04024 120x60

**Figure 1-16. Octal Numeric Response Data**

**Binary Numeric Response Data.**

A binary numeric response data is defined as follows:

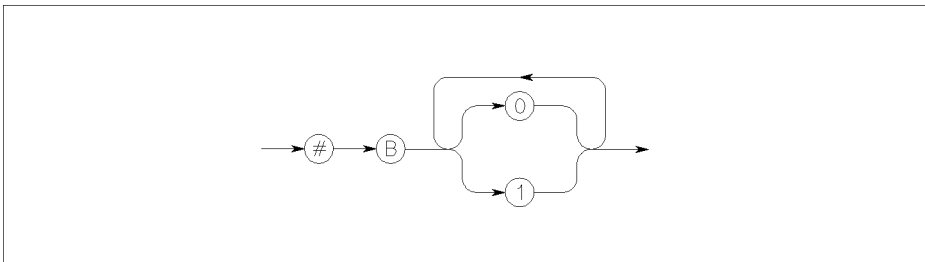

pg04025 120x40

**Figure 1-17. Binary Numeric Response Data**

**String Response Data.**

A string response data is defined as follows:

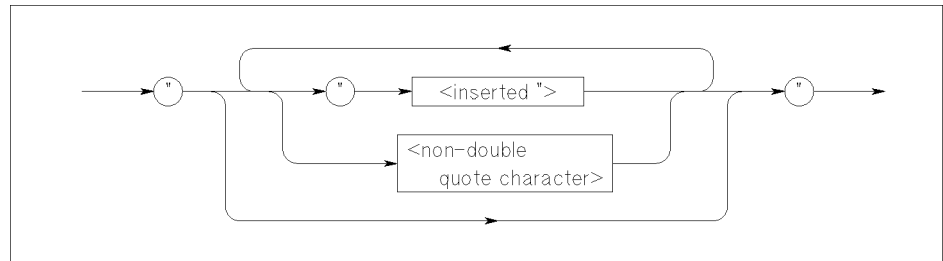

pg04026 120x40

**Figure 1-18. String Response Data**

**Response Message Syntax**

**Character Response Data.**

A character response data is similar to character parameter. The main difference is that character response data returns only the short form of a particular mnemonic, in all uppercase letters.



pg04027 120x30

**Figure 1-19. Character Response Data**

where <response mnemonic> is defined as follows:

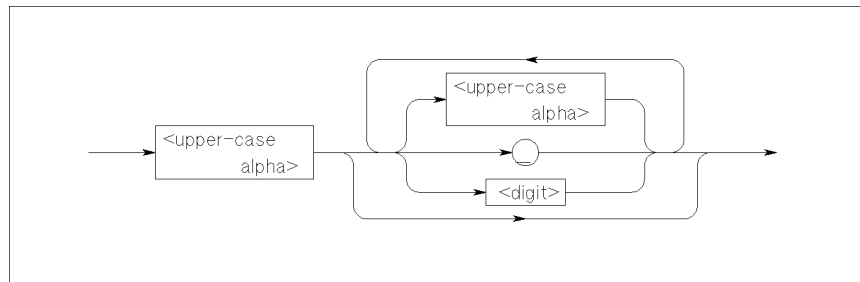

pg04028 120x40

**Figure 1-20. <response mnemonic>**

**Definite Length Arbitrary Block Response Data.**

A definite length arbitrary block response data is for a large number of related data and defined as follows:

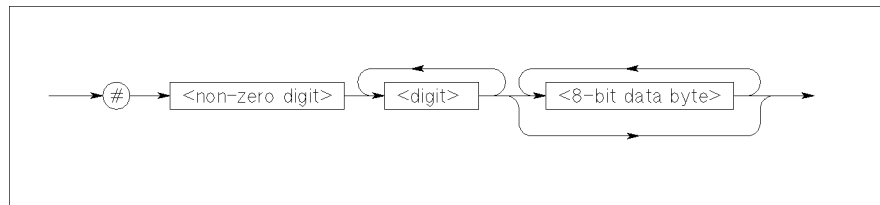

pg04029 120x30

**Figure 1-21. Definite Length Arbitrary Block Response Data**

The single decimal digit <non-zero digit> specifies how many <digit>s will follow.

The decimal number <digit>s specifies how many <8-bit data byte>s will follow.

**Indefinite length arbitrary block response data.**

An indefinite length arbitrary block response data is defined as follows:

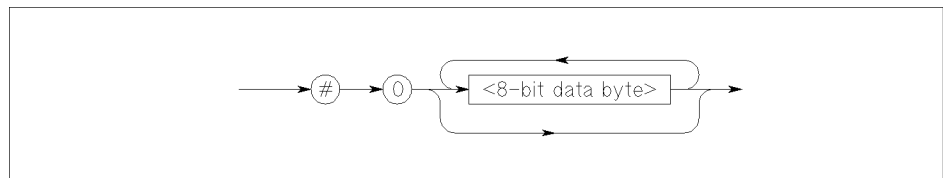

pg04030 120x30

**Figure 1-22. Indefinite Length Arbitrary Block Response Data**

---

## Status Reporting Structure

This section describes the status reporting structure used in the HP 4155A/4156A. These are IEEE488.2 status structures except for the following:

- Standard Operation Status Register (for SCPI)
- Questionable Status Register (for SCPI)
- Emergency Status Register (for HP 4155A/4156A)
- Measurement Stress/Status Register (for HP 4155A/4156)

For more information about these non-IEEE488.2 status structures, see “STATus Subsystem”.

In general, the status data structure is used to “request service” or indicate a specific condition (for example, operation complete) via SRQ (Service Request). Note that the user may be notified that certain events have occurred even if the user did not request the information.

Refer to the following figures for a model of the status data structure.

SCPI Commands  
**Status Reporting Structure**

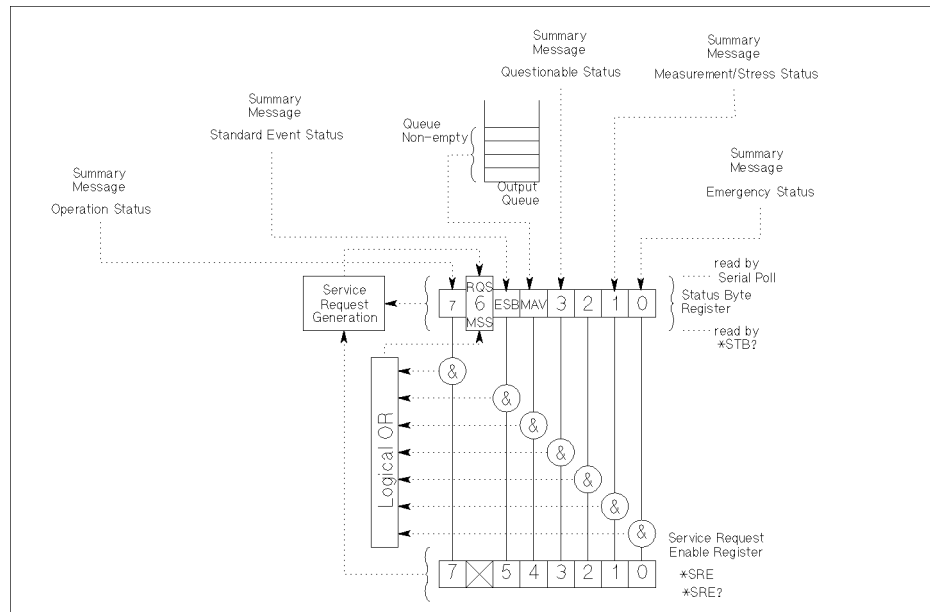

PG04001120x90

**Figure 1-23. Status Reporting Structure**

## Status Byte Register

The Status Byte register contains bits related to the instrument's Status Byte (STB) summary messages, Request Service (RQS) messages, and Master Summary Status (MSS) messages. Refer to Figure 1-24 and Table 1-36.

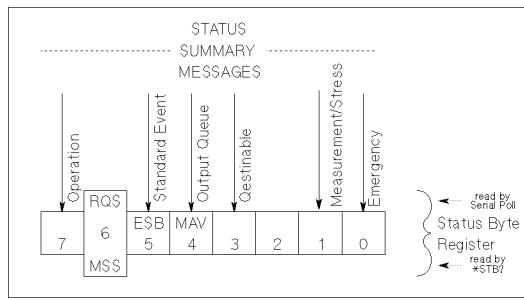

**Figure 1-24. Status Byte Register**



**Table 1-36. Status Byte Register**

Bit	Definition	Explanation
0	Emergency Status Bit Summary Message	Indicates whether one or more of the enabled Emergency Status Register bits is set.
1	Measurement/Stress Status Bit Summary Message	Indicates whether one or more of the enabled Measurement/Stress Status Register bits is set.
2	NOT USED	Always zero.
3	Questionable Status Bit Summary Message	Indicates whether one or more of the enabled Questionable Status Register bits is set.
4	Message Available  MAV  Queue Summary Message	Indicates whether the Output Queue is empty.
5	Standard Event Status Bit  ESB  Summary Message	Indicates whether one or more of the enabled Standard Events Status Register bits is set.
6	Request Service  RQS  Message	Indicates whether a SRQ  Service Request  has occurred.
	Master Summary Status  MSS  Summary Message	Indicates that the instrument has at least one reason for requesting service.
7	Operation Status Bit Summary Message	Indicates whether one or more of the enabled Operation Status Register bits is set.

The Status Byte Register can be read with either a serial poll or the READ STATUS BYTE common query (\*STB?). Both of these methods read the status byte message identically. However, the value returned for bit 6 depends on the method used.

## Service Request Enable Register

The Service Request Enable Register is an 8-bit register that can be used by the programmer to select which summary messages in the Status Byte Register may cause service requests. Refer to Figure 1-25.

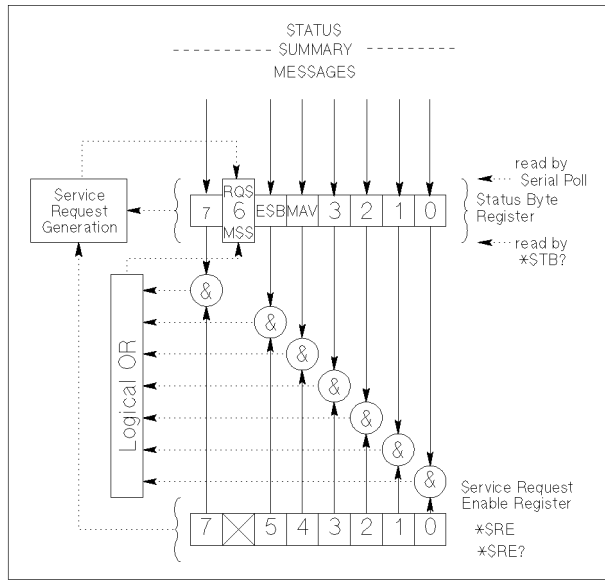

PG04003

**Figure 1-25. Service Request Enable Register**

## Standard Event Status Register

The Standard Event Status Register has specific events assigned to specific bits. Refer to Figure 1-26 and Table 1-37.

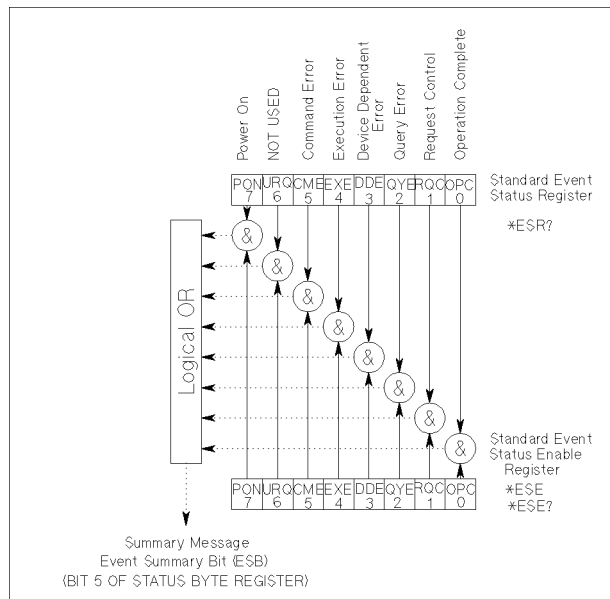

pg04004 80x80

**Figure 1-26. Standard Event Status Register**

**Status Reporting Structure****Table 1-37. Standard Event Status Register**

Bit	Definition	Explanation
0	Operation Complete [OPC]	This event bit is generated in response to the *OPC command. It indicates that HP 4155A/4156A has finished all pending operations.
1	Request Control [RQC]	This event bit indicates to the controller that HP 4155A/4156A is requesting permission to become the active controller-in-charge.
2	Query Error [QYE]	[1] An attempt is being made to read data from the Output Queue when no data is present or pending. [2] Data in the Output Queue has been lost.
3	Device Dependent Error [DDE]	This event bit indicates that an error has occurred which is neither a Command Error, a Query Error, or an Execution Error.
4	Execution Error [EXE]	<ul style="list-style-type: none"> <li>• A command &lt;parameter&gt; following a header was evaluated by HP 4155A/4156A as outside of its legal input range or is otherwise inconsistent with the HP 4155A/4156A's capabilities.</li> <li>• A valid command could not be properly executed due to some device condition.</li> </ul>
5	Command Error [CME]	A syntax error has been detected.
6	NOT USED	This bit is always zero.
7	Power On [PON]	This event bit indicates that an off-to-on transition has occurred in HP 4155A/4156A's power supply.
8 to 15	Reserved	These bits are always zero.

---

## Standard Event Status Enable Register

The Standard Event Status "Enable" Register is an 8-bit register that can be used by the program to select which bits of Standard Event Status Register are enabled. The enabled bits are ORed together, and reported to the ESB bit (Bit5) of the Status Byte Register.

The 8 bits of this register correspond to the 8 bits of the Standard Event Status Register. Refer to Figure 1-26.

## Output Queue

The Output Queue stores response messages until they are read. If an unread message exists, Bit4 (Message Available—MAV) of the Status Byte Register is set to 1. So, Bit4 is used to synchronize information exchange with the controller. Refer to Figure 1-27.

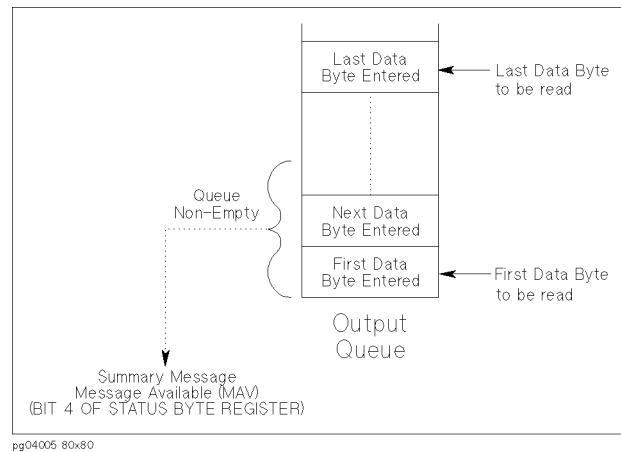

**Figure 1-27. Output Queue**

The Response Formatter places Data Byte Messages and END messages into the Output Queue in response to query commands. These messages are removed from the Output Queue as they are read by the controller. As long as the Output Queue contains an unread message, MAV is 1.

---

## Operation Status Register

This register consists of CONDITION, TRANSITION FILTER, EVENT, and event enable (MASK) registers.

- You enable the desired bits of the EVENT register by using the MASK register. 1 enables, 0 masks the corresponding bit of EVENT register. The MASK register is set by the :STATus:OPERation:ENABle command.
- The TRANSITION FILTER register consists of positive and negative transition filters.

If a bit in the *positive transition filter* is set to 1, then a 0 to 1 transition in the corresponding bit of the CONDITION register causes a 1 to be written in the corresponding EVENT register bit. The positive transition filter is set by the :STATus:OPERation:PTRansition command.

If a bit in the *negative transition filter* is set to 1, then a 1 to 0 transition in the corresponding bit of the CONDITION register causes a 1 to be written in the corresponding EVENT register bit. The negative transition filter is set by the :STATus:OPERation:NTRansition command.

See “STATus Subsystem” for details about these commands.

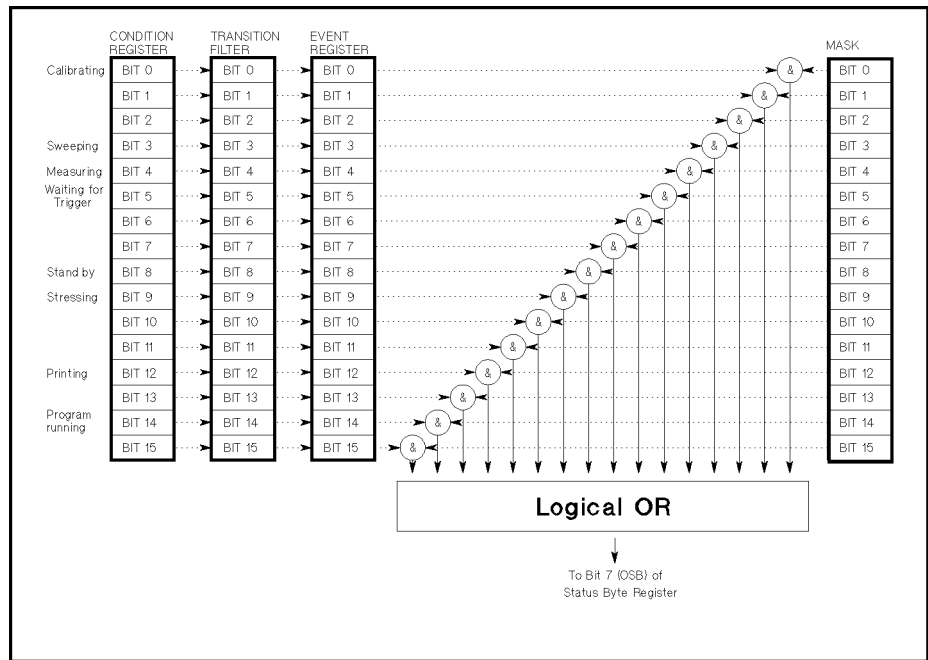

pp04006 12x120

**Figure 1-28. Operation Status Register**

This is a standard SCPI register, but non-IEEE488.2.

**Status Reporting Structure****Table 1-38. Operation Status Register**

Bit	Definition	Explanation
0	Calibrating	HP 4155A/4156A is currently performing a calibration.
1 to 2	NOT USED	Always zero.
3	Sweeping	A sweep is in progress.
4	Measuring	HP 4155A/4156A is actively measuring (sweep or sampling measurement).
5	Waiting for Trigger	HP 4155A/4156A is currently waiting for a trigger input.
6 to 7	NOT USED	Always zero.
8	Standby	HP 4155A/4156A is currently in the standby state.
9	Stressing	HP 4155A/4156A is currently in the stress forcing state.
10 to 11	NOT USED	Always zero.
12	Printing	A print/plot operation is in progress.
13	NOT USED	Always zero.
14	Program running	A user-defined program is currently in the run state.
15	NOT USED	Always zero.



---

## Questionable Status Register

This register consists of CONDITION, TRANSITION FILTER, EVENT, and event enable (MASK) registers.

- You enable the desired bits of the EVENT register by using the MASK register. 1 enables, 0 masks the corresponding bit of EVENT register. The MASK register is set by the :STATus:QUESTionable:ENABle command.
- The TRANSITION FILTER register consists of positive and negative transition filters.

If a bit in the *positive transition filter* is set to 1, then a 0 to 1 transition in the corresponding bit of the CONDITION register causes a 1 to be written in the corresponding EVENT register bit. The positive transition filter is set by the :STATus:QUESTionable:PTRansition command.

If a bit in the *negative transition filter* is set to 1, then a 1 to 0 transition in the corresponding bit of the CONDITION register causes a 1 to be written in the corresponding EVENT register bit. The negative transition filter is set by the :STATus:QUESTionable:NTRansition command.

See “STATus Subsystem” for details about these commands.

SCPI Commands  
**Status Reporting Structure**

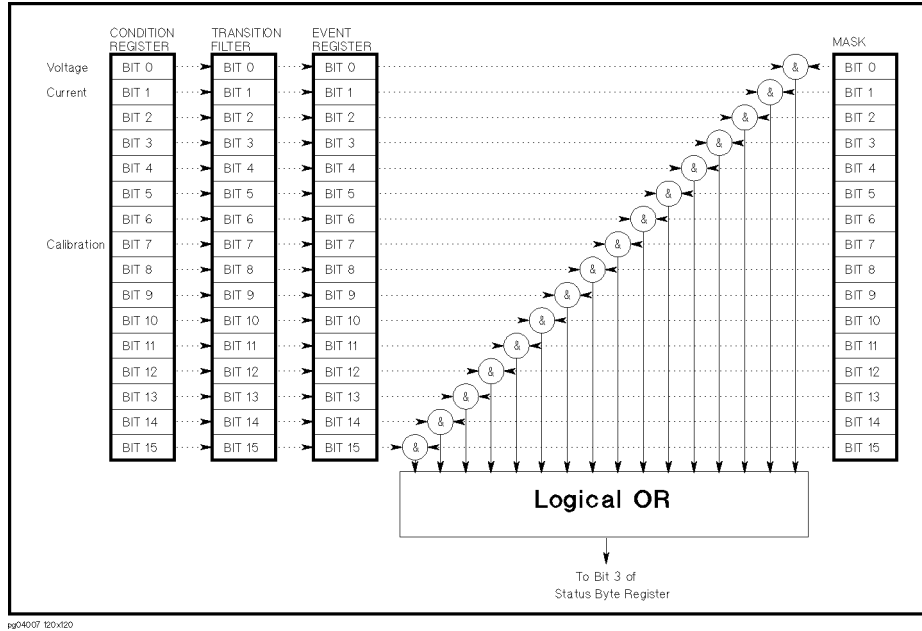

**Figure 1-29. Questionable Status Register**

This is a standard SCPI register, but non-IEEE488.2.

**Table 1-39. QUESTIONABLE STATUS REGISTER**

Bit	Definition	Explanation
0	Voltage	This bit indicates whether the HP 4155A/4156A forced or measured voltage without error.
1	Current	This bit indicates whether the HP 4155A/4156A forced or measured current without error.
2 to 6	NOT USED	These bits are always zero.
7	CALibration	This bit indicates whether the HP 4155A/4156A completed the self-calibration without error.
8 to 15	NOT USED	These bits are always zero.

## Emergency Status Register

This register consists of EVENT and event enable (MASK) registers.

You enable the desired bits of the EVENT register by using the MASK register. 1 enables, 0 masks the corresponding bit of EVENT register. The MASK register is set by the :STATUS:EMERGENCY:ENABLE command. See “STATUS Subsystem” for details about this command.

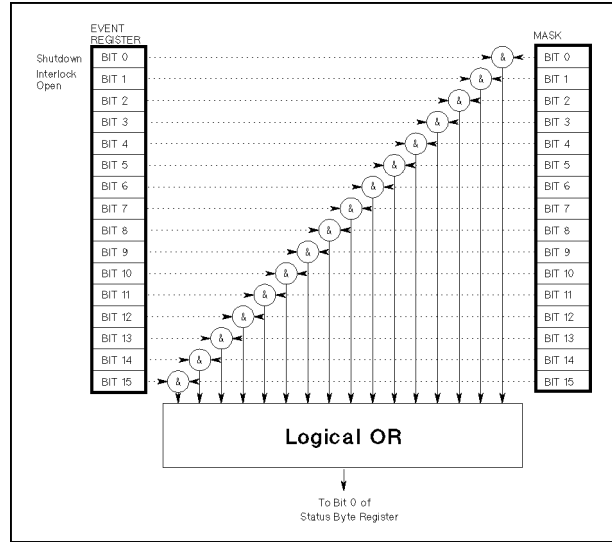

pg400312060

**Figure 1-30. Emergency Status Register**

This register is not a standard SCPI register.

**Status Reporting Structure****Table 1-40. EMERgency Status Register**

<b>Bit</b>	<b>Definition</b>	<b>Explanation</b>
0	Shut down	This bit is set when SMU output is shut down by the instrument to prevent damage to SMU.
1	Interlock open	This bit is set when the fixture lid is opened.
2 to 15	NOT USED	These bits are always zero.

## Measurement/Stress Status Register

This register consists of EVENT and event enable (MASK) registers.

You enable the desired bits of the EVENT register by using the MASK register. 1 enables, 0 masks the corresponding bit of EVENT register. The MASK register is set by the :STATUS:MEASurement:ENABLE command. See “STATUS Subsystem” for details about this command.

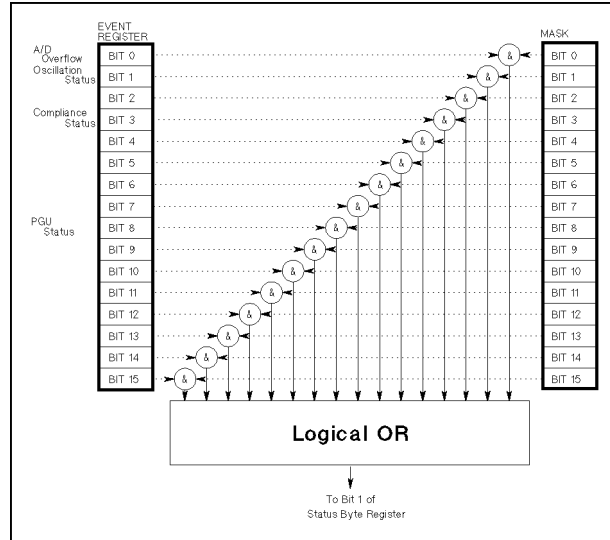

**Figure 1-31. Measurement/Stress Status Register**

This register is not a standard SCPI register.

**Status Reporting Structure****Table 1-41. Measurement/Stress Status Register**

<b>Bit</b>	<b>Definition</b>	<b>Explanation</b>
0	A/D Overflow	This bit is set if A/D converter overflows.
1	Oscillation Status	This bit is set if SMU oscillates.
2	NOT USED	This bit is always zero.
3	Compliance Status	This bit is set if SMU reaches compliance.
4 to 7	NOT USED	These bits are always zero.
8	PGU Status	This bit is set if PGU reaches the current limit.
9 to 15	NOT USED	These bits are always zero.

---

## Error Messages

Error Messages are classified by error number as listed in the following table:

**Table 1-42.**

<b>Error Range</b>	<b>Error Category</b>
0	No error
-100 to -199	Command Error
-200 to -299	Execution Error
-300 to -399	Device-Dependent Error
-400 to -499	Query Error
100 to 32767	HP 4155A/4156A specific error

Negative error numbers (Command Error, Execution Error, Device-Dependent Error, Query Error) are standard SCPI errors.

Positive error numbers are HP 4155A/4156A specific errors, not standard SCPI errors.

When HP 4155A/4156A is in the remote control state, the occurrence of an error (except for error number 0 or Emergency Error) sets the corresponding bit in the Standard Event Status Register. An Emergency Error sets the corresponding bit in the Emergency Status Register.

**Table 1-43.**

<b>Error Category</b>	<b>Standard Event Status Register Bit</b>
Command Error	bit5
Execution Error	bit4
Device-Specific Error	bit3
Query Error	bit2
Emergency Error	sets Emer. Status register
Others	bit3

---

## No Error

This message indicates that HP 4155A/4156A has no errors.

Error 0

### No error

The error queue is completely empty. Every error/event in the queue has been read or the queue was purposely cleared by power-on, \*CLS, and so on.

---

## Command Error

Error -100

### Command error

Generic syntax error that cannot be determined more specifically.

Error -101

### Invalid character

An invalid character for the type of a syntax element was received; for example, a header containing an ampersand.

Error -102

### Syntax error

An unrecognized command or data type was received; for example, a string was received when the HP 4155A/4156A does not accept strings.

Error -103

### Invalid separator

An illegal character was received when a separator was expected; for example, the semicolon was omitted after a program message unit.

Error -104

### Data type error

An improper data type was received; for example, numeric data was expected but string data was received.



- Error -105           **GET not allowed**  
A group execute trigger was received within a program message.
- Error -108           **Parameter not allowed**  
Too many parameters for the command were received.
- Error -109           **Missing parameter**  
Fewer parameters were received than required for the command.
- Error -110           **Command header error**  
An error was detected in the header. This error message is reported if the HP 4155A/4156A cannot determine the more specific header errors -111 through -114.
- Error -111           **Header separator error**  
An illegal character for a header separator was received; for example, no white space followed the header.
- Error -112           **Program mnemonic too long**  
The header contains more than twelve characters.
- Error -113           **Undefined header**  
An undefined command header was received; for example, \*XYZ.
- Error -114           **Header suffix out of range**  
The value of a numeric suffix attached to a program mnemonic is out of range; for example, :PAGE:CHAN:SMU7:MODE V specifies illegal SMU number 7.
- Error -120           **Numeric data error**  
Numeric (including the nondecimal numeric types) data error. This error message is reported when the HP 4155A/4156A cannot determine the more specific errors -121 through -128.

**Error Messages**

- Error –121           **Invalid character in number**  
An invalid character for the data type was received; for example, an alphacharacter was received when the type was decimal numeric.
- Error –123           **Exponent too large**  
The magnitude of the exponent was larger than 32000.
- Error –124           **Too many digits**  
The mantissa of a decimal numeric data contained more than 255 digits excluding leading zeros.
- Error –128           **Numeric data not allowed**  
Numeric data is not allowed in this position for this command header.
- Error –130           **Suffix error**  
An error was detected in the suffix. This error message is reported if the HP 4155A/4156A cannot determine the more specific suffix errors –131 through –138.
- Error –131           **Invalid suffix**  
The suffix does not follow the correct syntax or the suffix is inappropriate.
- Error –134           **Suffix too long**  
The suffix contains more than 12 characters.
- Error –138           **Suffix not allowed**  
A suffix was received after a numeric parameter that does not allow suffixes.
- Error –140           **Character data error**  
An error was detected in a character parameter. This error message is reported if the HP 4155A/4156A cannot determine the more specific errors –141 through –148.

- Error -141            **Invalid character data**  
Either the character parameter contains an invalid character or the particular element received is not valid for the command header.
- Error -144            **Character data too long**  
The character parameter contains more than 12 characters.
- Error -148            **Character data not allowed**  
A character parameter is not allowed for this position.
- Error -150            **String data error**  
An error was detected in a string parameter. This error is reported if the HP 4155A/4156A cannot determine a more specific error -151 and -158.
- Error -151            **Invalid string data**  
An invalid string parameter data was received; for example, an END message was received before the terminal quote character.
- Error -158            **String data not allowed**  
A string parameter data was received but was not allowed at this point.
- Error -160            **Block data error**  
An error was detected in a block data. This error is reported if the HP 4155A/4156A cannot determine more specific errors -161 and -168.
- Error -161            **Invalid block data**  
An invalid block data was received; for example, an END message was received before the length was satisfied.
- Error -168            **Block data not allowed**  
A legal block data was received but was not allowed at this point.

**Error Messages**

- Error -170      **Expression error**  
An error was detected in an expression. This error is reported if the HP 4155A/4156A cannot determine more specific errors -171 and -178.
- Error -171      **Invalid expression**  
The expression was invalid; for example, unmatched parentheses or an illegal character.
- Error -178      **Expression data not allowed**  
An expression was received but was not allowed at this point.

---

## **Execution Error**

The HP 4155A/4156A reports -2XX errors when it is unable to perform a valid programming command.

- Error -200      **Execution error**  
Generic execution error for the HP 4155A/4156A that cannot be determined more specifically.
- Error -201      **Invalid while in local**  
A command is not executable while the HP 4155A/4156A is in local mode due to a Hard Local Control.
- Error -202      **Settings lost due to rtl**  
A setting associated with a Hard Local Control was lost when the HP 4155A/4156A changed to Local State (LOCS) from Remote State (REMS) or to Local with Lockout State (LWLS) from Remote with Lockout State (RWLS).

Error -210	<b>Trigger error</b>
Error -211	<b>Trigger ignored</b> A GET(Group Execution Trigger), *TRG, or triggering signal was received and recognized by the HP 4155A/4156A but was ignored because of timing considerations; for example, the HP 4155A/4156A was not ready to respond.
Error -214	<b>Trigger deadlock</b> The trigger source for the initiation of a measurement is set to GET (Group Execution Trigger) and subsequent measurement query is received. The measurement cannot be started until a GET is received.
Error -220	<b>Parameter error</b> A parameter related error occurred and the HP 4155A/4156A cannot determine the more specific errors -221 through -224.
Error -221	<b>Settings conflict</b> A specified parameter setting could not be executed due to the present device state.
Error -222	<b>Data out of range</b> Interpreted value of the program was out of range as defined by the HP 4155A/4156A.
Error -223	<b>Too much data</b> Too much parameters for the HP 4155A/4156A was received.
Error -224	<b>Illegal parameter value</b> Illegal parameter value was received.
Error -230	<b>Data corrupt or stale</b> Possibly invalid data; new reading started but not completed since last access.

SCPI Commands

**Error Messages**

- Error -231      **Data questionable**  
Measurement accuracy is suspect.
- Error -240      **Hardware error**  
A hardware problem in the HP 4155A/4156A. This error message is reported if the HP 4155A/4156A cannot detect the more specific error -241.
- Error -241      **Hardware missing**  
A program command or query could not be executed because of missing hardware; for example, an option was not installed.
- Error -250      **Mass storage error**  
A mass storage error occurred. This error message is reported if the HP 4155A/4156A cannot determine the more specific errors -251 through -258.
- Error -251      **Missing mass storage**  
A program command or query could not be executed because of missing mass storage.
- Error -252      **Missing media**  
A program command or query could not be executed because of a missing media.
- Error -253      **Corrupt media**  
A program command or query could not be executed because of corrupt media; for example, bad disk or wrong format.
- Error -254      **Media full**  
A program command or query could not be executed because the media was full; for example, there is no room on the disk.
- Error -256      **File name not found**

A program command or query could not be executed because the file name on the disk was not found.

Error -257

**File name error**

A program command or query could not be executed because the file name on the disk was in error.

Error -258

**Media protected**

A program command or query could not be executed because the media was protected.

Error -260

**Expression error**

An expression related error occurred. This error message is reported if the HP 4155A/4156A cannot detect the more specific error -261.

Error -261

**Math error in expression**

An expression could not be executed due to a math error; for example, a divide-by-zero was attempted.

---

## Device-Specific Error

-3XX errors indicate that the HP 4155A/4156A has detected an error that is not a command error, a query error, or an execution error; some device operations did not properly complete, possibly due to an abnormal hardware or firmware condition. These codes are also used for self-test response errors.

Error -300

**Device-specific error**

Generic device-dependent error for the HP 4155A/4156A that cannot be determined more specifically.

SCPI Commands

**Error Messages**

- Error -310            **System error**  
Some error, termed "system error" by the HP 4155A/4156A, has occurred.
- Error -311            **Memory error**  
An error was detected in the HP 4155A/4156A's memory.
- Error -313            **Calibration memory lost**  
Nonvolatile data saved by the \*CAL? command has been lost.
- Error -315            **Configuration memory lost**  
Nonvolatile configuration data saved by the HP 4155A/4156A has been lost.
- Error -330            **Self-test failed**  
The self-test has failed.
- Error -350            **Queue overflow**  
This code is entered into the queue instead of the code that caused the error. This code indicates that there is no room in the queue and an error occurred but was not recorded.

---

**Query Error**

- Error -400            **Query error**  
Generic query error for the HP 4155A/4156A that cannot be determined more specifically.
- Error -410            **Query INTERRUPTED**  
A condition causing an INTERRUPTED query error occurred; for example, a query followed by DAB or GET before a response was completely sent.



- Error -420            **Query UNTERMINATED**  
A condition causing an UNTERMINATED query error occurred; for example, the HP 4155A/4156A was addressed to talk and an incomplete program message was received.
- Error -430            **Query DEADLOCKED**  
A condition causing a DEADLOCKED query error occurred; for example, both input buffer and output buffer are full and the HP 4155A/4156A cannot continue.
- Error -440            **Query UNTERMINATED after indefinite response**  
A query was received in the same program message after a query requesting an indefinite response was executed.

SCPI Commands  
**Error Messages**



---

**HP 4145B Syntax  
Command Set**

---

# HP 4145B Syntax Command Set

HP 4145B Syntax command set has same syntax as HP 4145A/B Semiconductor Parameter Analyzer command set.

So, you can execute HP 4145A/B programs on HP 4155A/4156A with minimum modification.

The differences between HP 4145B Syntax commands and HP 4145A/B commands are summarized in “Differences from HP 4145A/B Commands”.

This chapter describes the following:

- General Conventions
- Differences from HP 4145A/B Commands
- Reference: System Mode Commands
- Reference: User Mode Commands
- Reference: Common Mode Commands
- Service Request Status Byte

## **To Enter into HP 4145B Syntax Commands Mode.**

When HP 4155A/4156A is turned on, HP 4155A/4156A is always in HP 4155A/4156A commands mode.

To enter into HP 4145B syntax commands mode:

Frontpanel: set **COMMAND SET** field on the **SYSTEM: MISCELLANEOUS** page to **HP4145**.

Remote command: send “.:SYSTem:LANGUage COMPatibility” command to HP 4155A/4156A.

## **To Exit from HP 4145B Syntax Commands Mode.**

The command **\*RST** exits the HP 4145B Syntax Commands Mode and returns to the HP 4155A/4156A command set.

---

## General Conventions

### **Command Modes.**

There are three types of HP 4145B Syntax commands:

System Mode commands: Only work in System Mode.

User Mode commands: Only work in User Mode.

Common commands: Work in both System and User Mode.

- To change to System Mode, use DE, SS, SM, or MD command.
- To change to User Mode, use the US command.

The default setting is System Mode. Therefore, the first command of a program must be a System or Common Mode command.

A command issued in the wrong mode generates an error.

### **Command and Pages for System Mode.**

System Mode commands are related to a certain page(s). A System Mode command must be executed on its related page.

To change to the related page, use a page changing command:

DE	Channel Definition Page
SS	Sweep Setup Page
SM	Display Setup Page. This corresponds to Display Setup, Measurement Setup, or Sampling Setup page of HP 4155A/4156A.
MD	Graph or List Display Page (depends on DM command)

### **Parameter Separator.**

Parameters must be separated by single commas (,).

### **String Parameter.**

All string parameters, for example, channel names and file names, must be enclosed in single quotes ('*NAME*').

The first character of a string parameter must be an uppercase alphabetical character or <whitespace>. The remaining characters must be uppercase alphabetical, numeric, or <whitespace>.

## General Conventions

### Real Parameter.

Real numeric values can be entered in fixed or floating point format.

Example:

Fixed:           12.34 or -12.34

Floating:        1.23E+4 or 1.23E-4 or -1.23E+4 or -1.23E-4

Voltage (V), current (A), or time (S) units are not required after numeric values.

### Semicolons and <whitespace>.

A command can begin and end with multiple semicolons (;).

For example, ;;;CH1;;;CH2 is a legal command.

<whitespace> is allowed at the beginning or end of commands, and before and after parameters.

For example,       CH1 , 'VNAME' , 'INAME' , 1 , 1 is allowed.

<whitespace> is allowed between the command and the first parameter. For example, CH1 above can be CH 1.

### Invalid Input.

When invalid input generates a parsing error, the rest of the command is discarded until the next terminator (; or <CR> or <LF>). Then, the commands following this terminator are processed.

---

## Differences from HP 4145A/B Commands

This section summarizes the differences between HP 4145B syntax commands and HP 4145A/B commands:

- CH
  - SMU channel number

HP 4145 A/B	4145 syntax
1 to 4	1 to 6

- VR, IR
  - START setting range is expanded to HP 4155A/4156A's range.
  - STOP setting range is expanded to HP 4155A/4156A's range.
  - STEP setting range is expanded to HP 4155A/4156A's range.
  - COMPLIANCE setting range is expanded to HP 4155A/4156A's range.
  - Setting resolution is same as HP 4155A/4156A.
- VP, IP
  - START setting range is expanded to HP 4155A/4156A's range.
  - STEP setting range is expanded to HP 4155A/4156A's range.
  - Number of steps setting range is expanded to HP 4155A/4156A's range.
  - COMPLIANCE setting range is expanded to HP 4155A/4156A's range.
  - Setting resolution is same as HP 4155A/4156A.
- VC, IC
  - SMU channel number

HP 4145 A/B	4145 syntax
1 to 4	1 to 6

- Output setting range is expanded to HP 4155A/4156A's range
- Setting resolution is same as HP 4155A/4156A

**Differences from HP 4145A/B Commands**

- RT, FS

- VAR1' value

HP 4145A/B	4145 syntax
VAR1' = VAR1 + offset	VAR1' = VAR1 * ratio + offset
or	
VAR1' = VAR1 * ratio	

- VAR1' ratio specification

HP 4145A/B	4145 syntax
Applicable in LOG sweep only	Both ratio and offset work for LOG

- WT, IN

- Wait/Interval time setting range is expanded to HP 4155A/4156A's range.
  - Availability

HP 4145A/B	4145 syntax
Must be on DISPLAY SETUP page	Can be on Display Setup, Measurement Setup, or Sampling Setup page.

- Setting resolution is same as HP 4155A/4156A.

- NR

- No. of Readings (that is, number of samples) setting range is expanded to HP 4155A/4156A's range
  - Availability

HP 4145A/B	4145 syntax
Must be in DISPLAY SETUP	Must be in Display Setup, Measurement Setup or Sampling Setup page.

- Setting resolution is same as HP 4155A/4156A.



- DM3, DM4
  - Equivalent to DM1.
  - Availability

HP 4145A/B	4145 syntax
Must be in DISPLAY SETUP	Must be on Display Setup, Measurement Setup or Sampling Setup page.

- LI
  - Num. of Monitor Channels

HP 4145A/B	4145 syntax
1 to 6	1 to 8

- MX, SH
  - Not supported. Ignored.*
- AS1, AS2, AS3
  - Controls IBASIC program instead of ASP.
- SV
  - File type S (ASP file) is *not* supported; generates an error.
  - File name follows the HP 4155A/4156A file naming convention, but without the file extension.
  - Comment is ignored.
  - Supports both LIF and DOS media format.
  - Creates HP 4155A/4156A compatible file. Not HP 4145 compatible.
- GT
  - File type S (ASP file) is *not* supported; generates an error.
  - File name follows the HP 4155A/4156A file naming convention, but without the file extension.
  - Supports both LIF and DOS media format.
  - Recognizes HP 4155A/4156A and HP 4145 compatible files.

**Differences from HP 4145A/B Commands**

- DO
  - Channel name

HP 4145A/B	4145 syntax
Measurement channel name only	Source, measure, user function, user variable names.

- PR
  - Changes page to LIST Display prior to start printing.
  - Printing format is HP 4155A/4156A's data list format.
- GL0, GL1, GL2

*Not supported. Ignored.*
- DV
  - Channel number: 1 to 4, 7 to 8 for SMUs, 5 to 6 for VSUs, 9 to 10 for PGUs.
  - 2 V and 200 V ranges are available.
  - Output setting range is expanded to HP 4155A/4156A's range.
  - Compliance setting range is expanded to HP 4155A/4156A's range.
  - Setting resolution is same as HP 4155A/4156A.
- DI
  - Channel number

HP 4145A/B	4145 syntax
1 to 4	1 to 6

- 10 pA, 100 pA and 1 A output ranges are available.
- Output setting range is expanded to HP 4155A/4156A's range.
- Compliance setting range is expanded to HP 4155A/4156A's range.
- Setting resolution is same as HP 4155A/4156A.

- TV
  - Channel number

HP 4145A/B	4145 syntax
1 to 4	1 to 6

- IT
  - Integration time is same as HP 4155A/4156A.
- CA
  - Calibration time is different.
    - HP 4155A/4156A    about 15 s to 50 s (depends on its configuration)
    - HP 4145A/B        about 4 s
- PL
  - Printing format is HP 4155A/4156A's hard copy format.
- ID
  - Response text is same as defined for IEEE488.2 \*IDN response.
- All HP-GL Commands
  - *Not* supported. Ignored.

---

## System Mode Commands

**Table 2-1. System Mode Commands (1 of 2)**

<b>command</b>	<b>Description</b>	<b>Manual Page</b>
DE	Channel Definition Page	2-12
CH	SMU Definition	2-13
VS	VSU Definition	2-14
VM	VMU Definition	2-15
SS	Sweep Setup Page	2-16
VR	VAR1 Setting  Voltage Mode	2-17
IR	VAR1 Setting  Current Mode	2-18
VP	VAR2 Setting  Voltage Mode	2-19
IP	VAR2 Setting  Current Mode	2-20
VC	Constant SMU Setting  Voltage Mode	2-21
IC	Constant SMU Setting  Current Mode	2-22
SC	Constant VSU Setting	2-23
HT	Hold Time Setting	2-24
DT	Delay Time Setting	2-25
RT	VAR1' Ratio Setting	2-26
FS	VAR1' Offset Setting	2-27
SM	Measurement and Display Setup Page	2-28
WT	Wait Time  Time Domain Measurement	2-29
IN	Interval Time  Time Domain Measurement	2-30
NR	Number of Readings  Time Domain Measurement	2-31
DM	Display Mode Selection	2-32
XN	Graphics X-Axis Setting	2-33
YA	Graphics Y1-Axis Setting	2-33
YB	Graphics Y2-Axis Setting	2-33

**Table 2-2. System Mode Commands (2 of 2)**

<b>command</b>	<b>Description</b>	<b>Manual Page</b>
XT	Graphics Axis Setting	2-34
LI	List Mode	2-35
MX	Matrix Mode	2-36
SH	Schmoo Mode	2-37
MD	Measurement Display	2-37
ME	Measurement Selection	2-38
AS	Auto-Sequencing Selection	2-39
SV	File Save	2-40
GT	File Get	2-41
DO	Data Output Channel Query	2-42
PR	Print Function	2-44
GL	Graphics Language (GL1) Mode	2-44

## DE

Changes mode to System Mode, then changes page to Channel Definition page.

Syntax	DE
Example	OUTPUT @Hp4155; "DE"
Corresponding Command	:PAGE:CHAN

---

## CH

Defines the SMU name, mode, and function.

Syntax `CH SMU_number, 'VNAME', 'INAME', mode, function`

Parameters

Parameter	Explanation
<i>SMU_number</i>	1 to 6
<i>VNAME</i>	up to 6 alphanumeric characters
<i>INAME</i>	up to 6 alphanumeric characters
<i>(source) mode</i>	1 to 3 1: V 2: I 3: Common
<i>(source) function</i>	1 to 4 1: VAR1 2: VAR2 3: CONSTANT 4: VAR1'

Description Most recently executed page changing command must have been DE. The 4155A/4156A has up to 6 SMUs (depending on the configuration). If no parameters are specified after *SMU\_number*, the channel is disabled. If *mode* is set to 3 (Common), *function* must be set to 3 (CONSTANT).

Example `OUTPUT @Hp4155;"CH1, 'VNAME', 'INAME', 1, 2"`  
`OUTPUT @Hp4155;"CH2" Disable`

Corresponding Commands `:PAGE:CHAN:SMU<smu num>:VNAM 'VNAME'`  
`:PAGE:CHAN:SMU<smu num>:INAM 'INAME'`  
`:PAGE:CHAN:SMU<smu num>:MODE V | I | COMM`  
`:PAGE:CHAN:SMU<smu num>:FUNC VAR1 | VAR2 | CONS | VARD`  
Disable `:PAGE:CHAN:SMU<smu num>:DIS`

**System Mode Commands**

## VS

Defines the VSU name and function.

Syntax                    **VS** *Vsu\_number*, 'VNAME', *function*

Parameters

Parameter	Explanation
<i>Vsu_number</i>	1 to 2
<i>VNAME</i>	up to 6 alphanumeric characters
<i>(source) function</i>	1 to 4 1: VAR1 2: VAR2 3: CONSTANT 4: VAR1'

Description

Most recently executed page changing command must have been DE.

If no parameters are specified after *Vsu\_number*, the channel is disabled.

Example

```
OUTPUT @Hp4155;"VS1,'VNAME',1"
OUTPUT @Hp4155;"VS2"                    Disable
```

Corresponding Commands

Define Channel:

```
:PAGE:CHAN:VSU<vsu num>:VNAM 'VNAME'
:PAGE:CHAN:VSU<vsu num>:FUNC VAR1 | VAR2 | CONS | VARD
```

Disable:

```
:PAGE:CHAN:VSU<vsu num>:DIS
```



---

## VM

Defines the VM name.

Syntax                    **VM** *Vm\_number*, 'VNAME'

Parameters

<b>Parameter</b>	<b>Explanation</b>
<i>Vm_number</i>	1 to 2
<i>VNAME</i>	up to 6 alphanumeric characters

Description

Most recently executed page changing command must have been DE.

If no parameters are specified after *Vm\_number*, the channel is disabled.

Example

OUTPUT @Hp4155;"VM1,'VNAME' "

Corresponding Commands

Define Channel:

:PAGE:CHAN:VMU<*vm num*>:VNAM 'VNAME'

Disable:

:PAGE:CHAN:VMU<*vm num*>:DIS

## SS

Changes mode to System Mode, then changes page to Sweep Setup page ("Source Setup" on the HP 4145A/B).

Syntax	SS
Example	OUTPUT @Hp4155; "SS"
Corresponding Command	:PAGE:MEAS

## VR

Sets the sweep parameters for unit that was defined to be the VAR1 voltage sweep source.

Syntax `VR sweep_mode,start,stop,step,compliance`

Parameters

Parameter	Explanation
<i>sweep_mode</i>	1 to 4 1: Linear 2: Log 10 3: Log 25 4: Log 50
<i>start</i>	-200 V to 200 V
<i>stop</i>	-200 V to 200 V
<i>step</i>	-400 V to 400 V
<i>compliance</i>	-1 A to 1 A

Description

Most recently executed page changing command must have been SS. The VAR1 module must be in the voltage (V) source mode. If *sweep\_mode* is not 1 (Linear), the *step* value should be omitted. If *step* value is included, it will be ignored; no error is generated. If the VAR1 module is VSU, the *compliance* parameter is ignored. The *start*, *stop*, *step* and *compliance* parameters must comply with the maximum voltage/current limitation of the corresponding module. And the range and resolution for these parameters is same as for HP 4155A/4156A.

Example

```
OUTPUT @Hp4155;"VR1,0,1,0.01,100E-3" Linear
OUTPUT @Hp4155;"VR2,0,1,100E-3" Log
```

Corresponding Commands

```
:PAGE:MEAS:VAR1:SPAC LIN | L10 | L25 | L50
:PAGE:MEAS:VAR1:STAR start
:PAGE:MEAS:VAR1:STOP stop
:PAGE:MEAS:VAR1:STEP step
:PAGE:MEAS:VAR1:COMP compliance
```

**System Mode Commands**

## IR

Sets the sweep parameters for unit that was defined to be the VAR1 current sweep source.

Syntax `IR sweep_mode,start,stop,step,compliance`

Parameters

Parameter	Explanation
<i>sweep_mode</i>	1 to 4 1: Linear 2: Log 10 3: Log 25 4: Log 50
<i>start</i>	-1 A to 1 A
<i>stop</i>	-1 A to 1 A
<i>step</i>	-2 A to 2 A
<i>compliance</i>	-200 V to 200 V

Description

Most recently executed page changing command must have been **SS**. VAR1 unit must be in current (I) source mode. (VAR1 unit cannot be VSU).  
 If *sweep\_mode* is not 1 (Linear), the *step* value should be omitted.  
 If *step* value is included, it will be ignored; no error is generated. The *start*, *stop*, *step* and *compliance* parameters must comply with the maximum voltage/current limitation of the corresponding module. And the range and resolution for these parameters is same as for HP 4155A/4156A.

Example

```
OUTPUT @Hp4155;"IR1,0,1,0.01,200"      Linear
OUTPUT @Hp4155;"IR2,0,1,200"          Log
```

Corresponding Commands

```
:PAGE:MEAS:VAR1:SPAC LIN | L10 | L25 | L50
:PAGE:MEAS:VAR1:STAR start
:PAGE:MEAS:VAR1:STOP stop
:PAGE:MEAS:VAR1:STEP step
:PAGE:MEAS:VAR1:COMP compliance
```

---

## VP

Sets the sweep parameters for the unit that was defined to be the VAR2 voltage sweep source.

Syntax                    **VP** *start,step,num\_of\_steps,compliance*

Parameters

Parameter	Explanation
<i>start</i>	-200 V to 200 V
<i>step</i>	-400 V to 400 V
<i>num_of_steps</i>	1 to 128
<i>compliance</i>	-1 A to 1 A

Description

Most recently executed page changing command must have been **SS**.

Before executing this command, a unit must be defined to be VAR2 (the CH or VS command).

The VAR2 unit must be in the voltage (V) source mode.

If the VAR2 unit is a VSU, the *compliance* parameter is ignored.

The *start*, *step* and *compliance* parameters must comply with the maximum voltage/current limitation of the corresponding module. And the range and resolution for these parameters is same as for HP 4155A/4156A.

Example

**OUTPUT @Hp4155;"VP0,20E-6,5,1"**

Corresponding Commands

**:PAGE:MEAS:VAR2:STAR** *start*  
**:PAGE:MEAS:VAR2:STEP** *step*  
**:PAGE:MEAS:VAR2:POIN** *num\_of\_steps*  
**:PAGE:MEAS:VAR2:COMP** *compliance*

**System Mode Commands**

---

**IP**

Sets the sweep parameters for unit that was defined to be the VAR2 current sweep source.

Syntax `IP start,step,num_of_steps,compliance`

Parameters

Parameter	Explanation
<i>start</i>	-1 A to 1 A
<i>step</i>	-2 A to 2 A
<i>num_of_steps</i>	1 to 128
<i>compliance</i>	-200 V to 200 V

Description

Most recently executed page changing command must have been **SS**.

Before executing this command, a unit must be defined to be VAR2 (the CH command).

The VAR2 unit must be in the current (I) source mode. (So, VAR2 unit cannot be VSU).

The *start*, *step* and *compliance* parameters must comply with the maximum voltage/current limitation of the corresponding module. And the range and resolution for these parameters is same as for HP 4155A/4156A.

Example

`OUTPUT @Hp4155;"IP0,0.2,5,200"`

Corresponding Commands

```
:PAGE:MEAS:VAR2:STAR start
:PAGE:MEAS:VAR2:STEP step
:PAGE:MEAS:VAR2:POIN num_of_steps
:PAGE:MEAS:VAR2:COMP compliance
```

---

## VC

Sets the source parameters for an SMU that was defined to be a constant voltage source.

Syntax                    **VC** *SMU\_number*, *output\_value*, *compliance*

Parameters

Parameter	Explanation
<i>SMU_number</i>	1 to 6
<i>output_value</i>	-200 V to 200 V
<i>compliance</i>	-1 A to 1 A

Description

Most recently executed page changing command must have been **SS**.  
 The HP 4155A/4156A has up to 6 SMUs (depending on the configuration).  
 The CONSTANT SMU must be in the voltage (V) source mode.  
 The source function of the specified SMU channel must be **CONSTANT**.  
 The *output\_value* and *compliance* parameters must comply with the maximum voltage/current limitation of the corresponding module. And the range and resolution for these parameters is same as for HP 4155A/4156A.

Example

**OUTPUT @Hp4155;"VC1,10,0.1"**

Corresponding Commands

**:PAGE:MEAS:CONS:SMU**<*smu\_num*> *output\_value*  
**:PAGE:MEAS:CONS:SMU**<*smu\_num*>:**COMP** *compliance*

**System Mode Commands**

**IC**

Sets the source parameters for an SMU that was defined to be a constant current source.

Syntax                    **IC** *SMU\_number, output\_value, compliance*

Parameters

Parameter	Explanation
<i>SMU_number</i>	1 to 6
<i>output_value</i>	-1 A to 1 A
<i>compliance</i>	-200 V to 200 V

Description

Most recently executed page changing command must have been **SS**.  
 The specified SMU must be in the current (I) source mode.  
 The HP 4155A/4156A has up to 6 SMUs (depending on the configuration).  
 The source function of the specified SMU channel must be **CONSTANT**.  
 The *output\_value* and *compliance* parameters must comply with the maximum voltage/current limitation of the corresponding module. And the range and resolution for these parameters is same as for HP 4155A/4156A.

Example

**OUTPUT @Hp4155; "IC1, 1, 200"**

Corresponding Commands

**:PAGE:MEAS:CONS:SMU**<smu num> *output\_value*  
**:PAGE:MEAS:CONS:SMU**<smu num>:**COMP** *compliance*



---

## SC

Sets the source parameters for a VSU that was defined to be a constant source.

Syntax                    **SC** *Vsu\_number*, *output\_value*

Parameters

Parameter	Explanation
<i>Vsu_number</i>	1 to 2
<i>output_value</i>	-20 V to 20 V

Description

Most recently executed page changing command must have been **SS**.

The specified VSU must have been defined to be a **CONSTANT** source (**VS** command).

The range and resolution for the *output\_value* parameter are same as for HP 4155A/4156A.

Example

**OUTPUT @Hp4155;"SC1, 10"**

Corresponding Command

**:PAGE:MEAS:CONS:VSU<vsu num> output\_value**

**System Mode Commands**

## HT

Sets the hold time for sweep.

Syntax                   HT *hold\_time*

Parameter

Parameter	Explanation
<i>hold_time</i>	0.00 s to 655.35 s

Description

Most recently executed page changing command must have been **SS**.

Example

OUTPUT @Hp4155; "HT 1.5"

Corresponding Command

:PAGE:MEAS:HTIM *hold\_time*

---

## DT

Sets the delay time for sweep.

Syntax                    **DT** *delay\_time*

Parameter

<b>Parameter</b>	<b>Explanation</b>
<i>delay_time</i>	0.000 s to 65.535 s

Description              Most recently executed page changing command must have been **SS**.

Example                    OUTPUT @Hp4155;"DT 1.5"

Corresponding Command    :PAGE:MEAS:DEL *delay\_time*

**System Mode Commands**

---

**RT**

Sets the ratio value for the unit that was defined to be VAR1'.

Syntax                    RT *ratio*

Parameter

Parameter	Explanation
<i>ratio</i>	real numeric value

Description

Most recently executed page changing command must have been **SS**.

The VAR1' output value is determined by the following equation:

$$VAR1'value = VAR1value * ratio + offset$$

Before executing this command, a unit must be defined to be VAR1' (the CH or VS command).

Example

OUTPUT @Hp4155; "RT 0.1"

Corresponding Command

:PAGE:MEAS:VARD:RAT *ratio*

---

## FS

Sets the offset value of VARI'.

Syntax                    **FS** *offset*

Parameter

Parameter	Explanation
<i>offset</i>	real numeric value

Description

Most recently executed page changing command must have been **SS**.

The VARI' output value is determined by the following equation:

$$VARI'value = VARI'value * ratio + offset$$

Before executing this command, a unit must be defined to be VARI' (the CH or VS command).

Example

**OUTPUT @Hp4155;"FS 0.5"**

Corresponding Command

**:PAGE:MEAS:VARD:OFFS** *offset*

**System Mode Commands**

---

## SM

Changes mode to System Mode, then changes page to Display Setup page (“Meas & Disp Mode Setup” on the HP 4145A/B).

Syntax

**SM**

Description

On the HP 4145A/B, the **SM** command changes to the “Measurement and Display Mode Setup” page. On the HP 4155A/4156A, there are 3 corresponding pages: Display Setup, Sampling Setup, and Measurement Setup. **SM** changes the page to Display Setup page.

Example

OUTPUT @Hp4155; "SM"

Corresponding Commands

:PAGE:DISP

*Display Setup Page*

:PAGE:MEAS:SAMP

*Sampling Setup Page*

:PAGE:MEAS:MSET

*Measurement Setup Page*

---

## WT

Sets the hold time for sampling.

Syntax                    **WT** *wait\_time*

Parameter

Parameter	Explanation
<i>wait_time</i>	-30.0 ms to 838.8607 s

Description

Most recently executed page changing command must have been **SM**.

For time domain measurements (sampling measurement), VAR1 cannot be selected on the Channel Definition Page.

The mode must be Sampling mode (that is, all functions must be CONSTANT). 'WT' is not allowed in Sweep mode.

The *wait\_time* range and resolution are the same as the range and resolution of the HP 4155A/4156A sampling hold time.

Example

**OUTPUT @Hp4155;"WT 1.5"**

Corresponding Command

**:PAGE:MEAS:SAMP:HTIM *hold\_time***

**System Mode Commands**

**IN**

Sets the initial sampling interval (Interval time of time domain measurement).

Syntax                    **IN** *interval\_time*

Parameter

Parameter	Explanation
<i>interval_time</i>	60 $\mu$ s to 65.532 s

Description

Most recently executed page changing command must have been **SM**.  
 For sampling measurement (time domain measurements), VAR1 cannot be selected on the Channel Definition page.  
 The mode must be Sampling mode (that is, all functions must be CONSTANT). **IN** is not allowed in Sweep mode.  
 The *interval\_time* range and resolution are the same as range and resolution of the HP 4155A/4156A initial sampling interval.

Example                    OUTPUT @Hp4155; "IN 0.5"

Corresponding Command    :PAGE:MEAS:SAMP:IINT *interval\_time*



---

## NR

Sets number of readings (that is, number of samples) for sampling measurement (time domain measurement).

Syntax                    **NR** *num\_readings*

Parameter

Parameter	Explanation
<i>num_readings</i>	1 to 10001

Description

Most recently executed page changing command must have been **SM**.

For sampling measurement (time domain measurements), VAR1 cannot be selected on the Channel Definition Page.

The mode must be Sampling mode (that is, all functions must be CONSTANT). **NR** is not allowed in Sweep mode.

Example

OUTPUT @Hp4155;"NR 5"

Corresponding Command

:PAGE:MEAS:SAMP:POIN *num\_readings*

**System Mode Commands**

---

**DM**

Selects the display mode.

Syntax

**DM** *display\_mode*

Parameter

Parameter	Explanation
<i>display_mode</i>	1 to 4 1: GRAPHICS 2: LIST 3: GRAPHICS 4: GRAPHICS

Description

Most recently executed page changing command must have been **SM**.**DM** determines whether the GRAPHICS or LIST page is displayed when **MD** command is executed.

The HP 4145A/B Matrix (MX command) and Schmoo (SH command) are not supported.

- If DM is sent with parameter **3** or **4** (to select Matrix or Schmoo), it is equivalent to selecting parameter **1** (Graphics). And the page is changed to the Display Setup page.
- If the MX or SH commands themselves are sent, no error is generated. The commands are simply ignored.

Example

OUTPUT @Hp4155; "DM1"

Corresponding Command

:PAGE:DISP:MODE GRAP | LIST

---

## XN, YA, YB

These commands set the graphics axis parameters.

Syntax                    **XN|YA|YB** '*data\_name*', *scale*, *min*, *max*  
 XN = X axis (for sweep only; for sampling, use **XT**)  
 YA = Y1 axis  
 YB = Y2 axis

Parameters

Parameter	Explanation
<i>data_name</i>	must be a name previously defined on the Channel Definition page, User Function page, or User Variable page.
<i>scale</i>	1 to 2 1: Linear 2: Logarithmic
<i>min (value)</i>	real numeric value
<i>max (value)</i>	real numeric value

Description              Most recently executed page changing command must have been **SM**. And **DM1** must be executed.

For Sweep, VAR1 must be set up. And you can use **XN**, **YA**, and **YB**.

For Sampling, do not use VAR1 (that is, all functions must be **CONSTANT**). And you can use **YA** and **YB**. For X axis, do not use **XN**. Use **XT**.

The Y2 axis (**YB**) is optional; the **YB** command can be omitted.

Example                    `OUTPUT @Hp4155;"XN'NAME',1,0,10"`

Corresponding Commands    `:PAGE:DISP:GRAP:X | Y1 | Y2:NAME var_name`  
                                  `:PAGE:DISP:GRAP:X | Y1 | Y2:SCAL LIN | LOG`  
                                  `:PAGE:DISP:GRAP:X | Y1 | Y2:MIN min_value`  
                                  `:PAGE:DISP:GRAP:X | Y1 | Y2:MAX max_value`

**System Mode Commands**

**XT**

Sets the graphics parameters (X axis only) for sampling measurement (time domain measurement).

Syntax                    **XT** *min,max*

Parameters

Parameter	Explanation
<i>min (value)</i>	real numeric value
<i>max (value)</i>	real numeric value

Description

Most recently executed page changing command must have been **SM**. And **DM1** must be executed.

For sampling measurement (time domain measurements), VAR1 cannot be selected.

Mode must be Sampling (that is, all functions must be CONSTANT). **XT** is not allowed in Sweep mode.

Scale is Linear for sampling measurement (time domain measurement.)

For setting Y1 and Y2 axis, use the **YA** and **YB** commands.

Example

OUTPUT @Hp4155;"XT 0,10"

Corresponding Commands

:PAGE:DISP:GRAP:X:MIN *min\_value*  
 :PAGE:DISP:GRAP:X:MAX *max\_value*

---

## LI

Assigns channel names for List display.

Syntax                    `LI 'name' { , 'name' }`

Parameters

<b>Parameter</b>	<b>Explanation</b>
<i>(data) name</i>	from 1 to 8 names can be selected. The channel names must be names previously defined on the Channel Definition page, User function page, or User Variable page.

Description

Most recently executed page changing command must have been **SM**. And **DM2** must be executed.

The allowed number of channel names (eight) differs from the number allowed for HP 4145A/B (six).

Example

```
OUTPUT @Hp4155;"LI 'NAME'"  
OUTPUT @Hp4155;"LI 'NAME1', 'NAME2', 'NAME3', 'NAME4'"
```

Corresponding Command

```
:PAGE:DISP:LIST 'name', {'name'}
```

**System Mode Commands**

---

**MX**

This command is ignored on HP 4155A/4156A.

Syntax

**MX**

Description

The Matrix Display Mode is not supported. If the MX command is sent, it is ignored; no error is generated.

Sending **DM3** (set Display Mode to Matrix), however, changes the page to the Display Setup page, and uses the default values there.

---

## SH

This command is ignored on HP 4155A/4156A.

Syntax                   SH

Description            The Schmoor Display Mode is not supported. If the SH command is sent, it is ignored; no error is generated.

                          Sending **DM4** (set Display Mode to Schmoor), however, changes the page to the Display Setup page, and uses the default values there.

---

## MD

Changes mode to System Mode, then changes page to the LIST or GRAPH page, depending on DM command.

Syntax                   MD

Example                 OUTPUT @Hp4155;"MD"

Corresponding Commands    :PAGE:GLIS                    *To Graph Display Page*  
                              :PAGE:GLIS:LIST                *To List Display Page*

**System Mode Commands**

**ME**

Triggers measurement with the specified measurement execution mode.

Syntax                    **ME** *meas\_code*

Parameter

Parameter	Explanation
<i>meas_code</i>	1 to 4 1: Single 2: Repeat 3: Append 4: Stop

Description              Valid on any System Mode page.

Example                    **OUTPUT @Hp4155;"ME1"**

Corresponding Command    **:PAGE:SCON:SING | REP | APP | STOP**



---

## AS

The command controls the IBASIC program execution, instead of ASP execution.

Syntax                    **AS** *auto\_seq\_code*

Parameter

<b>Parameter</b>	<b>Explanation</b>
<i>auto_seq_code</i>	1 to 3 1: Start 2: Continue 3: Stop

Description              AS3 pauses the IBASIC program; does not stop it.  
Valid on any System Mode page.

Example                    OUTPUT @Hp4155;"AS1"

Corresponding Command    :PROG:STAT RUN | CONT | PAUS

**System Mode Commands**

## SV

Saves measurement setup and/or measurement results into file.

Syntax

**SV** '*filetype*<space>*filename*<space>*comment*'

Parameters

Parameter	Explanation
<i>filetype</i>	P or D P: Program File [measurement setup] D: Program/Data File [measurement setup and results]
<i>filename</i>	File name
<i>comment</i>	[ignored] User's comment

The string parameter of SV must be enclosed in single quotes:

Example: **SV 'P MYFILE'**

Description

HP 4145A/B *filetype* S (ASP File) is not supported and generates an error.

The file name should comply with HP 4155A/4156A file naming conventions. The extension is added automatically, so do not specify an extension (suffix) in the *filename*.

The second <space> and the *comment* are optional. Ignored if specified.

Handles both LIF and MS-DOS format disk.

Creates HP 4155A/4156A compatible file; not HP 4145B compatible file.

Valid on any System Mode page.

Example

OUTPUT @Hp4155;"SV 'P MYFILE COMMENT'"

Corresponding Commands

P Type (Program File) :MMEM:STOR:STAT O, *filename*  
 D Type (Prog/Data File) :MMEM:STOR:TRAC DEF *filename*

## GT

Gets measurement setup and/or measurement results from file.

Syntax `GT 'filetype<space>filename'`

Parameters

Parameter	Explanation
<i>filetype</i>	P or D P: Program File (measurement setup) D: Program/Data File (measurement setup and results)
<i>filename</i>	File name

The string parameter of GT must be enclosed in single quotes:  
 Example: `GT 'P MYFILE'`

Description

The HP 4145A/B *filetype* S (ASP File) is not supported and generates an error.  
 The file name should comply with HP 4155A/4156A file naming conventions.  
 Do not specify an extension (suffix) in the *filename*.  
 Handles both LIF and DOS format disk.  
 Recognizes HP 4155A/4156A and HP 4145B compatible files.  
 Valid on any System Mode page.

Example

`OUTPUT @Hp4155;"GT 'P MYFILE' "`

Corresponding Commands

P Type (Program File) : `MMEM:LOAD:STAT 0, filename`  
 D Type (Prog/Data File) : `MMEM:LOAD:TRAC DEF filename`

## DO

Outputs measurement data of the specified channel (name) to the controller.

Syntax DO '*name*'

Parameter

Parameter	Explanation
<i>(data) name</i>	must be a name previously defined on the Channel Definition page, User Function page, or User Variable page.

Response

*status value <delimiter>* [*status value <delimiter>*] *<terminator>*

Response	Explanation
<i>(data) status</i>	N   T   C   P   X   V   D   A   S N: Normal T: Other channel compliance error C: This channel compliance error P: PG exceeding current limit error X: Oscillation V: ADC overflow D: Insufficient data A: Arithmetic error S: Calculation stack overflow
<i>value</i>	HP 4145 compatible format or IEEE488.2 <NR3 NUMERIC RESPONSE DATA> format.
<i>&lt;delimiter&gt;</i>	Selected by DP command. , or <CR>+<LF>
<i>&lt;terminator&gt;</i>	Selected by DL command. <CR>+<LF> with or without EOI Selected by EI command.

Description Measurement value name, source value name, user function name, or user variable name can be specified.

Valid on any System Mode page.

Status D, A, and S reported only for user function value.

Example

- Example 1: Response data is HP 4145 compatible format

```
DIM A(1:3)
OUTPUT @Hp4155;"DO 'NAME' "
ENTER @Hp4155;A(*)
```

Response is in HP 4145 compatible format:

```
N 0.0000E+00,N 100.00E-03,N 200.00E-03<CR><LF>^<END>
```

- Example 2: Response data is NR3 format

```
DIM A(1:3)
OUTPUT @Hp4155;"DP1"
OUTPUT @Hp4155;"DO 'NAME' "
ENTER @Hp4155;A(*)
```

Response is in NR3 format:

```
N+0.000000E+000,N+1.000000E-001,N+2.000000E-001<CR><LF>^<END>
```

Corresponding Command Query: `:TRAC? 'channel_name'`

**System Mode Commands**

---

## PR

Changes page to LIST Display page, switches the hard copy language to PCL, then starts printing the data list.

Syntax	PR
Description	<p>This command does not affect any print/plot parameters except the hard copy language.</p> <p>Print out format is compatible with HP 4155A/4156A.</p> <p>Valid on any System Mode page.</p>
Corresponding Commands	<pre>:PAGE:GLIS:LIST :HCOP:DEV:LANG PCL :HCOP:ITEM:ALL</pre>

---

## GL

This command is ignored on HP 4155A/4156A.

Syntax	GL
Description	<p>The Graphics Language Mode (GL1) is not supported. If the GL command is sent, no error is generated; the next command is parsed.</p>

---

## User Mode Commands

**Table 2-3. User Mode Commands**

<b>command</b>	<b>Description</b>	<b>Manual Page</b>
US	Mode Change	2-46
DV	SMU Output (Voltage Source)	2-47
DI	SMU Output (Current Source)	2-48
DS	VSU Output	2-49
TV	Triggering Measurement (Voltage Monitor)	2-50
TI	Triggering Measurement (Current Monitor)	2-52
GL	Graphics Language (GL2) Mode	2-54

**No Corresponding HP 4155A/4156A commands**

The User Mode commands have no corresponding HP 4155A/4156A commands.

HP-GL commands are not supported. For details, refer to “HP-GL Commands”.

**User Mode Commands**

---

## US

Changes mode to User Mode.

Syntax

**US**

Description

To change back to System Mode, send any of the following paging commands:  
DE, SS, SM, or MD.

Example

**OUTPUT @Hp4155; "US"**



---

## DV

Triggers voltage output from specified SMU, VSU, or PGU.

Syntax `DV channel_number,output_range,output_value,compliance`

Parameters

Parameter	Explanation
<i>channel_number</i>	1 to 4: SMU1 to SMU4 5: VSU1 6: VSU2 7: SMU5 8: SMU6 9: PGU1 10: PGU2
<i>output_range</i>	-1 to 4 -1: 2 V 0: AUTO 1: 20 V 2: 40 V 3: 100 V 4: 200 V
<i>output_value</i>	-200 V to 200 V
<i>compliance</i>	-1 A to 1 A

Description

HP 4155A/4156A can have up to 6 SMUs. DV can trigger a VSU, PGU, or SMU. For non-SMUs, *compliance* parameter is ignored. If no parameters are specified after *channel\_number*, channel is disabled. The *output\_range*, *output\_value* and *compliance* parameters must comply with the maximum voltage/current limitation of the corresponding module. Otherwise, an error is generated the same as for HP 4155A/4156A. And the range and resolution for these parameters is same as for HP 4155A/4156A.

Example

```
OUTPUT @Hp4155;"DV1,0,12.34,0.001"
OUTPUT @Hp4155;"DV2" Disable
```

## DI

Triggers current output from specified SMU.

Syntax `DI SMU_number, output_range, output_value, compliance`

Parameters

Parameter	Explanation
<i>SMU_number</i>	1 to 6
<i>output_range</i>	0 to 10, -1 to -2 -2: 10 pA -1: 100 pA 0: AUTO 1: 1 nA 2: 10 nA 3: 100 nA 4: 1 uA 5: 10 uA 6: 100 uA 7: 1 mA 8: 10 mA 9: 100 mA 10: 1 A
<i>output_value</i>	-1 A to 1 A
<i>compliance</i>	-200 V to 200 V

Description

HP 4155/4156A can have up to 6 SMUs. *output\_range*, *output\_value*, and *compliance* must comply with maximum voltage/current of corresponding module. If not, error is generated same as for HP 4155A/4156A. Range and resolution for these parameters is same as for HP 4155A/4156A. If no parameters after *SMU\_number*, SMU is disabled.

Example

```
OUTPUT @Hp4155; "DI1, 0, 9.876E-3, 10"
OUTPUT @Hp4155; "DI4" Disable
```

---

## DS

Triggers voltage output from specified VSU.

Syntax            **DS** *Vsu\_number, output\_value*

Parameters

<b>Parameter</b>	<b>Explanation</b>
<i>Vsu_number</i>	1 to 2
<i>output_value</i>	-20 V to 20 V

Description        If no parameters are specified after *Vsu\_number*, the channel is disabled.

Example            `OUTPUT @Hp4155;"DS2, 10.0"`  
                     `OUTPUT @Hp4155;"DS1"        Disable`

**User Mode Commands****TV**

Triggers voltage measurement by specified unit, then outputs measurement result data to controller.

Syntax **TV** *channel\_number*

Parameter

Parameter	Explanation
<i>channel_number</i>	1 to 8 1 to 4: SMU1 to SMU4 5: VMU1 6: VMU2 7: SMU5 8: SMU6

Response *status channel V value <terminator>*

Response	Explanation
<i>(data) status</i>	N   T   C   P   X   V N: Normal T: Other channel compliance error C: This channel compliance error P: PG exceeding current limit error X: Oscillation V: ADC overflow

Response	Explanation
<i>channel</i>	A   B   C   D   E   F   G   H A: SMU1 B: SMU2 C: SMU3 D: SMU4 E: VMU1 F: VMU2 G: SMU5 H: SMU6
<i>value</i>	HP 4145 compatible format or IEEE488.2 <NR3 NUMERIC RESPONSE DATA> format Selected by DP command.
<terminator>	<CR>+<LF> with or without EOI Selected by EI command.

Description            The HP 4155A/4156A has up to 6 SMUs (depending on the configuration)  
The command applies the range and resolution specifications of HP  
4155A/4156A for the measurement.

Example                 OUTPUT @Hp4155;"TV2"  
ENTER @Hp4155 USING "A,A,A,K";S\$,C\$,M\$,V

Response in HP 4145 compatible format:  
NBV 1.2345E+00<CR><LF>^<END>

Response in NR3 format:  
NBV+1.234567E+00<CR><LF>^<END>

**User Mode Commands**

## TI

Triggers current measurement by specified unit, then outputs measurement result data to controller.

Syntax **TI** *channel\_number*

Parameter

Parameter	Explanation
<i>channel_number</i>	1 to 4, 7 to 8 1 to 4: SMU1 to SMU4 7 to 8: SMU5 to SMU6

Response

*status channel I value <terminator>*

Response	Explanation
<i>(data) status</i>	N   T   C   P   X   V N: Normal T: Other channel compliance error C: This channel compliance error P: PG exceeding current limit error X: Oscillation V: ADC overflow
<i>channel</i>	A   B   C   D   G   H A: SMU1 B: SMU2 C: SMU3 D: SMU4 G: SMU5 H: SMU6
<i>value</i>	HP 4145 compatible format or IEEE488.2 <NR3 NUMERIC RESPONSE DATA> format Selected by DP command.
<i>&lt;terminator&gt;</i>	<CR>+<LF> with or without EOI Selected by EI command.

Description                    The HP 4155/56A has up to 6 SMUs (depending on the configuration)  
The command applies the range and resolution specifications of HP  
4155A/4156A for the measurement.

**NOTE**

Note that SMU5 and SMU6 are specified by **TI7** and **TI8**, respectively.

Example                        `OUTPUT @Hp4155;"TI7"`  
                                 `ENTER @Hp4155 USING "A,A,A,K";S$,C$,M$,V`  
Response in HP 4145 compatible format:  
                                 `NGI 7.6543E-03<CR><LF>^<END>`  
Response in NR3 format:  
                                 `NGI+7.654321E-003<CR><LF>^<END>`

**User Mode Commands**

---

## GL

This command is ignored on HP 4155A/4156A.

Syntax

GL

Description

The Graphics Language Mode (GL2) is not supported. If the GL command is sent, no error is generated; the next command is parsed.

---

## HP-GL Commands

The following User Mode HP-GL Commands (VECTOR, CHARACTER, LINE TYPE, AXES, SETUP, and CONFIGURATION & STATUS Groups) are not supported. However, inputting these commands does not generate an error. Input until the next terminator (; or CR or LF) is ignored. For example, if the line "PU ;DE" were sent, only DE would be executed.

### VECTOR Group

- PU (Pen Up)
- PD (Pen Down)
- PA (Plot Absolute)
- PR (Plot Relative)

### CHARACTER Group

- CS (Designates Standard Character Set)
- LB (Label)
- DR (Relative Direction)
- SR (Relative Character Size)
- CP (Character Plot)

### LINE TYPE Group

- LT (Line Type)
- SP (Pen Select)
- VS (Velocity Select)



AXES Group

XT (X Tick)  
YT (Y Tick)

SETUP Group

IP (Input P1 and P2)  
OP (Output P1 and P2)  
IW (Input Window)

CONFIGURATION and STATUS Group

DF (Default)  
IN (Initialize)  
IM (Input Mask)  
OE (Output Error)  
OS (Output Status)

---

## Common Mode Commands

<b>Common Mode Commands</b>		
<b>command</b>	<b>Description</b>	<b>Manual Page</b>
DC	Calibration on Device Clear	2-57
DL	Delimiter	2-58
DP	Double Precision	2-59
EI	Terminator	2-60
IT	Integration Time	2-61
SF	Self-Test	2-62
DR	Data Ready Service Request	2-63
BC	HP-IB Data Output Buffer Clear	2-64
CA	Auto-Calibration	2-65
PL	Plotting Function	2-66
PF	Print/Plot Function Abort	2-67
ID	Identification Output	2-68

---

## DC

This command selects whether the calibration is performed or not on sending Device Clear.

Syntax                    *DC calibration*

Parameters

<b>Parameter</b>	<b>Explanation</b>
<i>calibration</i>	1 or 2 1: does not perform calibration 2: performs calibration

Description              Default setting is 1.

Example                    `OUTPUT @Hp4155;"DC2"`

**Common Mode Commands**

## DL

This command selects delimiter of output data.

Syntax `DL delimiter`

Parameter

Parameter	Explanation
<i>delimiter</i>	1 or 2 1: comma 2: <CR><LF>

Description

This command selects data delimiter of output data specified by DO command in System mode.

Default setting is comma (DL1).

Example

```
OUTPUT @Hp4155;"DL2"
OUTPUT @Hp4155;"DO 'NAME' "
ENTER @Hp4155;A(*)
```

Response:

```
N 0.0000E+00<CR><LF>N 100.00E-03<CR><LF>N 200.00E-03<CR><LF>~<END>
```

---

## DP

This command selects precision of output data.

Syntax                    DP *double\_precision*

Parameter

Parameter	Explanation
<i>double_precision</i>	0 or 1 0: HP 4145 compatible format 1: double precision [NR3 format]

Description

In *HP4145 syntax command mode*, default data length of response data corresponding to DO, TI, and TV commands is same as HP 4145. DP command can change the data length of response data to double precision, which is standard data precision of HP 4155A/4156A.

Double precision format of response data for each command is as follows:

- DO (System mode)

$X \pm N.NNNNNNE \pm NNN \langle \text{delimiter} \rangle X \pm N.NNNNNNE \pm NNN \langle \text{delimiter} \rangle \dots X \pm N.NNNNNNE \pm NNN \langle \text{CR} \rangle \langle \text{LF} \rangle \sim \langle \text{END} \rangle$

X:     Data Status

N:     Measurement Data

- TV or TI (User mode)

$XXX \pm N.NNNNNNE \pm NNN \langle \text{CR} \rangle \langle \text{LF} \rangle \sim \langle \text{END} \rangle$

X:     Data Status

N:     Measurement Data

### Device Clear

Device Clear does not affect the setting of this command.

**Common Mode Commands**

**EI**

This command selects data terminator of output data.

Syntax                    **EI** *terminator*

Parameters

Parameter	Explanation
<i>terminator</i>	0 or 1 0: <CR><LF> 1: <CR><LF> with EOI, where EOI means ^<END>

Description              Default setting is 1.

Example                    **OUTPUT @Hp4155; "EI0"**

---

## IT

This command sets the integration time to SHORT, MEDIUM or LONG, according to the HP 4155A/4156A integration time definition; does not comply with the HP 4145A/B integration time definition.

Syntax                    **IT** *integ\_time*

Parameter

Parameter	Explanation
<i>integ_time</i>	1 to 3 1: SHORT 2: MEDIUM 3: LONG

Description

HP 4155A/4156A setting for SHORT and LONG integration time is effective for HP 4145B syntax mode. There is no way to change these values from the HP 4145B syntax command set. However, these values are reset to default when HP 4155A/56A switches to HP 4145B syntax mode. So, these values are default values until operator changes the values at front panel after 4155A/4156A has switched into the HP 4145B syntax mode.

Example

OUTPUT @Hp4155;"IT1"

Corresponding Command

:PAGE:MEAS:MSET:ITIM SHOR | MED | LONG

HP 4145B Syntax Command Set  
**Common Mode Commands**

---

**SF**

Executes the built-in self-test of HP 4155A/4156A.

Syntax	<b>SF</b>
Description	Bit 3 of HP 4145B syntax mode status byte is set when self-test is completed.
Example	<code>OUTPUT @Hp4155; "SF"</code>
Corresponding Command	<code>:DIAG:TEST 111</code>



---

## DR

Enables the Data Ready Service Request.

Syntax                    **DR** *service\_request*

Parameters

<b>Parameter</b>	<b>Explanation</b>
<i>service_request</i>	0 or 1 0: off 1: on

Description

If Data Ready Service Request is on, bit 1 (Data Ready) and bit 7 (RQS) of HP 4145B syntax mode status byte are set to 1 when measurement data is valid.

If Data Ready Service Request is off, only bit 1 (Data Ready) of the HP 4145B syntax mode status byte is set to 1 when measurement data is valid.

Corresponding Command

No HP 4155A/4156A command exactly corresponds to the DR command.  
:STAT:OPER:ENAB causes HP 4155A/4156A to perform a similar operation, but on a different status register.

**Common Mode Commands**

---

## BC

This command clears the HP-IB data output buffer and bit 1 (Data Ready) of the HP 4145B syntax mode status byte.

Syntax	BC
Description	A Buffer Clear must be performed before data output.
Corresponding Command	No HP 4155A/4156A command exactly corresponds to the BC command. On the HP 4155A/4156A, Device Clear performs this operation.

---

## CA

Auto-Calibration

Syntax                    **CA** *auto-calibration*

Parameters

Parameter	Explanation
<i>auto-calibration</i>	0 or 1 0: off 1: on

Description

For System Mode, **CA1** performs calibration immediately, and enables auto-calibration.

For User Mode, **CA1** performs calibration immediately, but does not enable auto-calibration.

If the mode changes (SYSTEM to USER or USER to SYSTEM), auto-calibration is turned off.

Example

OUTPUT @Hp4155;"CA1"

Corresponding Commands

**:CAL:AUTO ON | OFF** enables/disables auto-calibration only; does not actually perform calibration.

No HP 4155A/4156A command exactly corresponds to CA command.

The **\*CAL?** query performs calibration, and returns result response. The **CA** command does not return the result response.

**Common Mode Commands**

---

**PL**

This command calculates and sets up the HP 4155A/56A Output Region according to the specified parameters and the paper size.

Syntax **PL** *x\_min, y\_min, x\_max, y\_max*

Parameters

Parameter	Explanation
<i>x_min (value)</i>	0 to 65535
<i>y_min (value)</i>	0 to 65535
<i>x_max (value)</i>	0 to 65535
<i>y_max (value)</i>	0 to 65535

Description

If the calculation result exceeds 100%, it will be rounded down to 100%.

After setting the Output Region, the command switches the hard copy language to HP-GL, then starts plotting the present page.

This command does not affect any print/plot parameters except the hard copy language.

Plot format is compatible with HP 4155A/4156A.

Corresponding Commands

```
:HCOP:PAGE:DIM:LLEF x, y
:HCOP:PAGE:DIM:URIG x, y
:HCOP:DEV:LANG HPGL
:HCOP:ITEM:ALL
```

---

## PF

This command aborts the printing or plotting that is currently being performed.

Syntax	PF
Corresponding Command	:HCOP:ABOR

**Common Mode Commands**

## ID

Returns the identification string, which contains the HP 4155A/4156A model and revision numbers.

Syntax                    ID

Response                HEWLETT-PACKARD, *model#*, 0, *HOSTC\_rev*:*SMUC\_rev*:*ADC\_rev*<*term*>

Response	Explanation
<i>Model#</i>	4155A   4156A
<i>HOSTC_rev</i>	nn.nn
<i>SMUC_rev</i>	nn.nn
<i>ADC_rev</i>	nn.nn
< <i>term</i> >	<CR>+ <LF> with or without EOL. Selected by EI command.

Example

```
DIM A$[101]
OUTPUT @Hp4155;"ID"
ENTER @Hp4155;A$
```

Response:

```
HEWLETT-PACKARD, 4155A, 0, 01.00:01.00:01.00<CR><LF>^<END>
```

**NOTE**

For HP 4145A/B, ID returns 16 characters. For HP 4155A/4156B, ID returns 41 characters. So, you need to make sure the data string variable is large enough to contain the returned characters.

Corresponding Command    Query:                    \*IDN?

---

## HP 4145B Syntax Mode Status Byte

In general, the bit assignment of the status byte in HP 4145B syntax command mode is identical to the 4145 definition.

<b>Bit 8</b>	<b>Bit 7</b>	<b>Bit 6</b>	<b>Bit 5</b>	<b>Bit 4</b>	<b>Bit 3</b>	<b>Bit 2</b>	<b>Bit 1</b>
Emergency	RQS	Self-test Fail	Busy	Illegal Program	END Status	Syntax Error	Data Ready

HP 4145B Syntax Command Set

**HP 4145B Syntax Mode Status Byte**

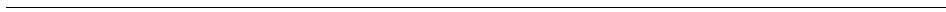



**Manual Changes  
Depending on ROM Version**

---

## Manual Changes Depending on ROM Version

HP 4155A/4156A may vary slightly, depending on the version of the ROM based firmware. The information in this manual applies to an HP 4155A/4156A with the following ROM version.

### Manual Applies to this ROM Version

ROM	ROM Version
HOSTC	01.02

#### ROM version

To confirm your ROM version, check the **SOFTWARE REVISION** field on the **SYSTEM: CONFIGURATION** page.

This chapter contains information for customizing this manual so that it is correct for the HP 4155A/4156A that you are using.

To customize this manual for your HP 4155A/4156A, refer to the following table, and make the manual changes depending on the ROM version of your HP 4155A/56A.

### Manual Changes by ROM version

ROM version (HOSTC)	Make Manual Changes
01.00	1
01.01	1

---

## Change 1

The following commands are not available:

- SCPI Commands
  - :HCOPY:DEVIce:CMOD
  - :HCOPY:ITEM[:WINDow]:TEXT3:STATe
- HP 4145B Syntax Commands (Common Mode Commands)
  - DC
  - DL
  - DP
  - EI

Manual Changes Depending on ROM Version

**Change 1**





Index

---

# Index

- A arbitrary
  - block parameters. block.
  - block response data. block.
  
- B binary
  - data transfer. block.
  - parameters. numeric parameters.
  - response data. response data.binary-weighted value. numeric parameters.  
block
  - binary transfer, 1-34-35
  - parameters (definite length), 1-350
  - parameters (indefinite length), 1-350
  - program data (indefinite length), 1-296
  - response data (definite length), 1-360
  - response data (indefinite length), 1-296, 1-361
  
- C CALibration subsystem commands, 1-4-9  
character
  - parameters, 1-349
  - response data, 1-359command message unit, 1-345  
commands
  - common (IEEE 488.2). common.
  - HP 4145 compatible. HP 4145 compatible.
  - SCPI. SCPI.
  - subsystem. subsystem commands.common (IEEE 488.2)  
commands, 1-3, 1-333-344  
conventions
  - functional syntax. syntax conventions.
  - textual notation. textual notation.

- D** DATA subsystem commands, 1-10-19
  - decimal
    - parameters. numeric parameters.
    - response data. response data.
  - definite length
    - parameters. block.
    - response data. block.
- DIAGNostic subsystem commands, 1-20-26
- DISPlay subsystem commands, 1-27-32
  
- E** Emergency Status register, 1-375
- END terminator, 1-345
- EOI, 1-345
- error messages, 1-379-389
- exponent
  - in response data, 1-356
  - numeric parameter, 1-348
  
- F** FORMat subsystem commands, 1-33-35
  - functional syntax conventions. syntax conventions.
  
- H** HCOPy subsystem commands, 1-36-68
  - hexadecimal
    - papameters. numeric parameters.
    - response data. response data.
  
- I** IEEE 488.1
  - commands, 1-2
- IEEE 488.2
  - commands, 1-2, 1-3
  - status reporting structure, 1-362
- indefinite length
  - parameters. block.
  - response data. block.
  
- M** MAX character parameter, 1-348
- Measurement/Stress Status register, 1-377
- message unit
  - command. command message unit.
  - program. program message unit.
  - query. query message unit.
- MIN character parameter, 1-348
- MMEMory subsystem commands, 1-69-81

- N** notation  
textual. textual notation.  
NR1 numeric response data. response data.  
NR2 numeric response data. response data.  
NR3 numeric response data. response data.  
numeric parameter  
binary, 1-351  
decimal, 1-347  
exponent, 1-347  
hexadecimal, 1-351  
octal, 1-351  
numeric program data  
binary, 1-303  
binary-weighted value, 1-303  
decimal, 1-303  
hexadecimal, 1-303  
octal, 1-303
- O** octal  
parameters. numeric parameters.  
response data. response data.  
Operation Complete  
flag, 1-334, 1-338, 1-344  
Operation Status register, 1-370  
Output Queue, 1-369
- P** PAGE subsystem commands, 1-82-292  
paper sizes, 1-64  
parameters  
arbitrary block. block.  
character. character.  
exponent. exponent.  
numeric. numeric parameters.  
string. string.  
program message, 1-345  
unit, 1-345  
PROGram subsystem commands, 1-293-301
- Q** query  
response message. response message.  
query message unit, 1-345  
Questionable Status register, 1-373



**R** response data  
 arbitrary block. block.  
 binary, 1-358  
 character. character.  
 decimal, 1-355  
 hexadecimal, 1-357  
 NR1 numeric, 1-355  
 NR2 numeric, 1-356  
 NR3 numeric, 1-356  
 octal, 1-357  
 string. string.  
 response message  
 syntax, 1-353

**S** SCPI, 1-2  
 error messages, 1-379  
 status registers, 1-362  
 Service Request Enable register, 1-366  
 SRQ  
 service request, 1-362  
 Standard Event Status Enable register, 1-368  
 Standard Event Status register, 1-367  
 status  
 reporting structure, 1-362-378  
 Status Byte register, 1-364  
 STATus subsystem commands, 1-302-316  
 string  
 parameters, 1-348  
 response data, 1-358  
 subsystem commands, 1-2  
 calibration. CALibration subsystem commands.  
 data. DATA subsystem commands.  
 diagnostic. DIAGnostic subsystem commands.  
 display. DISPlay subsystem commands.  
 format. FORMat subsystem commands.  
 hard copy. HCOPy subsystem commands.  
 mass memory. MMEMory subsystem commands.  
 page setup. PAGE subsystem commands.  
 program. PROGram subsystem commands.  
 status. STATus subsystem commands.  
 system. SYSTem subsystem commands.  
 trace. TRACe subsystem commands.  
 syntax  
 response message. response message.  
 syntax conventions  
 functional syntax conventions, 1-345  
 SYSTem subsystem commands, 1-317-332

**T** textual notation, 1-3  
TRACe subsystem commands, 1-10-19