ADVANTEST®

ADVANTEST CORPORATION

TQ8325

Digital Optical Wavelength Meter

Operation Manual

MANUAL NUMBER FOE-8324207J02

Safety Summary

To ensure thorough understanding of all functions and to ensure efficient use of this instrument, please read the manual carefully before using. Note that Advantest bears absolutely no responsibility for the result of operations caused due to incorrect or inappropriate use of this instrument.

If the equipment is used in a manner not specified by Advantest, the protection provided by the equipment may be impaired.

- **Warning Labels**

Warning labels are applied to Advantest products in locations where specific dangers exist. Pay careful attention to these labels during handling. Do not remove or tear these labels. If you have any questions regarding warning labels, please ask your nearest Advantest dealer. Our address and phone number are listed at the end of this manual.

Symbols of those warning labels are shown below together with their meaning.

DANGER: Indicates an imminently hazardous situation which will result in death or serious personal injury.

WARNING: Indicates a potentially hazardous situation which will result in death or serious personal injury.

CAUTION: Indicates a potentially hazardous situation which will result in personal injury or a damage to property including the product.

- **Basic Precautions**

Please observe the following precautions to prevent fire, burn, electric shock, and personal injury.

- Use a power cable rated for the voltage in question. Be sure however to use a power cable conforming to safety standards of your nation when using a product overseas.
- When inserting the plug into the electrical outlet, first turn the power switch OFF and then insert the plug as far as it will go.
- When removing the plug from the electrical outlet, first turn the power switch OFF and then pull it out by gripping the plug. Do not pull on the power cable itself. Make sure your hands are dry at this time.
- Before turning on the power, be sure to check that the supply voltage matches the voltage requirements of the instrument.
- Connect the power cable to a power outlet that is connected to a protected ground terminal. Grounding will be defeated if you use an extension cord which does not include a protected ground terminal.
- Be sure to use fuses rated for the voltage in question.
- Do not use this instrument with the case open.
- Do not place anything on the product and do not apply excessive pressure to the product. Also, do not place flower pots or other containers containing liquid such as chemicals near this

product.

- When the product has ventilation outlets, do not stick or drop metal or easily flammable objects into the ventilation outlets.
- When using the product on a cart, fix it with belts to avoid its drop.
- When connecting the product to peripheral equipment, turn the power off.

- **Caution Symbols Used Within this Manual**

Symbols indicating items requiring caution which are used in this manual are shown below together with their meaning.

DANGER: Indicates an item where there is a danger of serious personal injury (death or serious injury).

WARNING: Indicates an item relating to personal safety or health.

CAUTION: Indicates an item relating to possible damage to the product or instrument or relating to a restriction on operation.

- **Safety Marks on the Product**

The following safety marks can be found on Advantest products.



: ATTENTION - Refer to manual.



: Protective ground (earth) terminal.



: DANGER - High voltage.



: CAUTION - Risk of electric shock.

- **Replacing Parts with Limited Life**

The following parts used in the instrument are main parts with limited life.

Replace the parts listed below before their expected lifespan has expired to maintain the performance and function of the instrument.

Note that the estimated lifespan for the parts listed below may be shortened by factors such as the environment where the instrument is stored or used, and how often the instrument is used.

The parts inside are not user-replaceable. For a part replacement, please contact the Advantest sales office for servicing.

Each product may use parts with limited life.

For more information, refer to the section in this document where the parts with limited life are described.

Main Parts with Limited Life

Part name	Life
Unit power supply	5 years
Fan motor	5 years
Electrolytic capacitor	5 years
LCD display	6 years
LCD backlight	2.5 years
Floppy disk drive	5 years
Memory backup battery	5 years

- **Hard Disk Mounted Products**

The operational warnings are listed below.

- Do not move, shock and vibrate the product while the power is turned on. Reading or writing data in the hard disk unit is performed with the memory disk turning at a high speed. It is a very delicate process.
- Store and operate the products under the following environmental conditions.
 - An area with no sudden temperature changes.
 - An area away from shock or vibrations.
 - An area free from moisture, dirt, or dust.
 - An area away from magnets or an instrument which generates a magnetic field.
- Make back-ups of important data. The data stored in the disk may become damaged if the product is mishandled. The hard disc has a limited life span which depends on the operational conditions. Note that there is no guarantee for any loss of data.

- **Precautions when Disposing of this Instrument**

When disposing of harmful substances, be sure dispose of them properly with abiding by the state-provided law.

Harmful substances: (1) PCB (polycarbon biphenyl)
 (2) Mercury
 (3) Ni-Cd (nickel cadmium)
 (4) Other
 Items possessing cyan, organic phosphorous and hexadic chromium and items which may leak cadmium or arsenic (excluding lead in solder).

Example: fluorescent tubes, batteries

Environmental Conditions

This instrument should be only be used in an area which satisfies the following conditions:

- An area free from corrosive gas
- An area away from direct sunlight
- A dust-free area
- An area free from vibrations
- Altitude of up to 2000 m

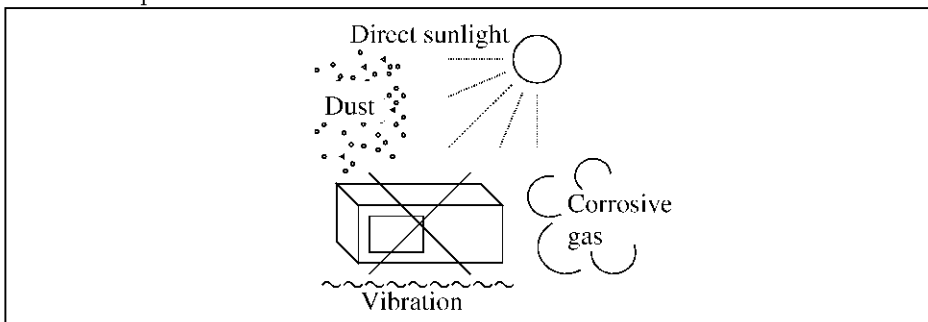

Figure-1 Environmental Conditions

- Operating position

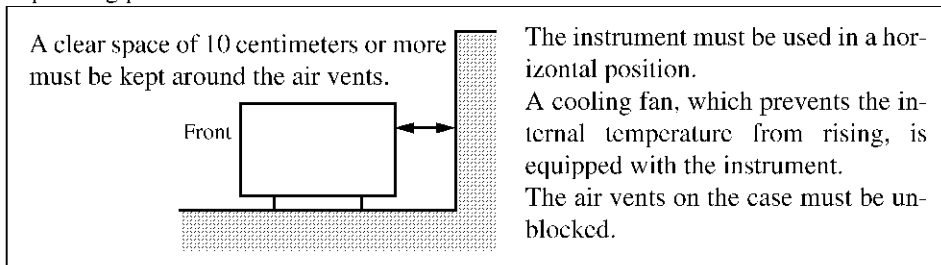

Figure-2 Operating Position

- Storage position

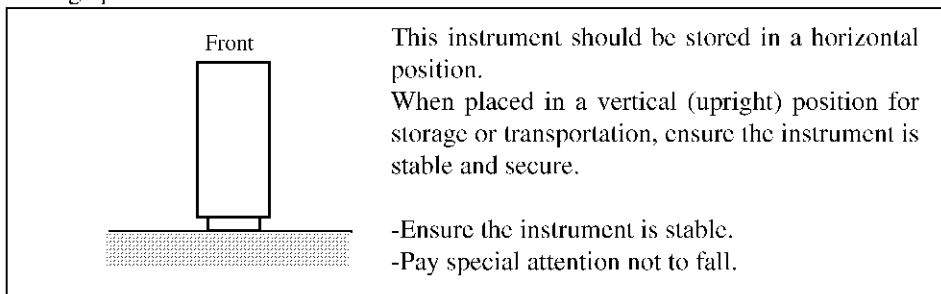

Figure-3 Storage Position

- The classification of the transient over-voltage, which exists typically in the main power supply, and the pollution degree is defined by IEC61010-1 and described below.

Impulse withstand voltage (over-voltage) category II defined by IEC60364-4-443

Pollution Degree 2

Types of Power Cable

Replace any references to the power cable type, according to the following table, with the appropriate power cable type for your country.

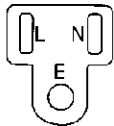
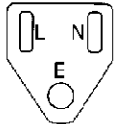
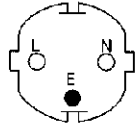
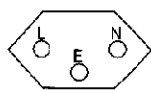
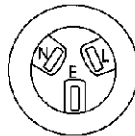
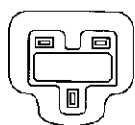
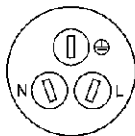
Plug configuration	Standards	Rating, color and length	Model number (Option number)
	PSE: Japan Electrical Appliance and Material Safety Law	125 V at 7 A Black 2 m (6 ft)	Straight: A01402 Angled: A01412
	UL: United States of America CSA: Canada	125 V at 7 A Black 2 m (6 ft)	Straight: A01403 (Option 95) Angled: A01413
	CEE: Europe DEMKO: Denmark NEMKO: Norway VDE: Germany KEMA: The Netherlands CEBEC: Belgium OVE: Austria FIMKO: Finland SEMKO: Sweden	250 V at 6 A Gray 2 m (6 ft)	Straight: A01404 (Option 96) Angled: A01414
	SEV: Switzerland	250 V at 6 A Gray 2 m (6 ft)	Straight: A01405 (Option 97) Angled: A01415
	SAA: Australia, New Zealand	250 V at 6 A Gray 2 m (6 ft)	Straight: A01406 (Option 98) Angled: -----
	BS: United Kingdom	250 V at 6 A Black 2 m (6 ft)	Straight: A01407 (Option 99) Angled: A01417
	CCC: China	250 V at 10 A Black 2 m (6 ft)	Straight: A114009 (Option 94) Angled: A114109

Certificate of Conformity

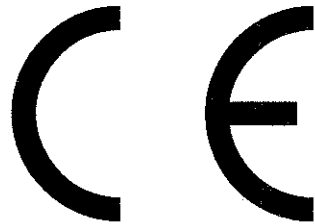

This is to certify, that

Optical Wavelength Meter

TQ8325

instrument, type, designation

complies with the provisions of the EMC Directive 89/336/EEC in accordance with EN50081-1 and EN50082-1.

ADVANTEST Corp.

Tokyo, Japan

ROHDE&SCHWARZ

Engineering and Sales GmbH

Munich, Germany

Table of Power Cable Options

There are six power cable options (refer to following table).



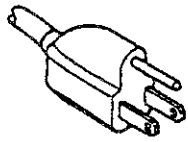
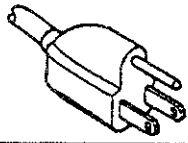
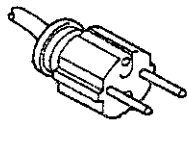
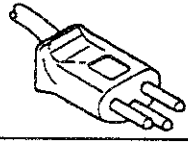
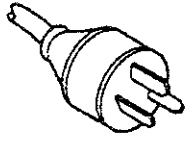
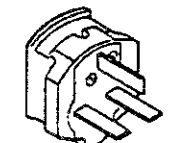







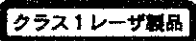

Order power cable options by Model number.

	Plug configuration	Standards	Rating, color and length	Model number (Option number)
1		JIS: Japan Law on Electrical Appliances	125 V at 7 A Black 2 m (6 ft)	Straight: A01402 Angled: A01412
2		UL: United States of America CSA: Canada	125 V at 7 A Black 2 m (6 ft)	Straight: A01403 (Option 95) Angled: A01413
3		CEE: Europe DEMKO: Denmark NEMKO: Norway VDE: Germany KEMA: The Netherlands CEBEC: Belgium OVE: Austria FIMKO: Finland SEMKO: Sweden	250 V at 6 A Gray 2 m (6 ft)	Straight: A01404 (Option 96) Angled: A01414
4		SEV: Switzerland	250 V at 6 A Gray 2 m (6 ft)	Straight: A01405 (Option 97) Angled: A01415
5		SAA: Australia, New Zealand	250 V at 6 A Gray 2 m (6 ft)	Straight: A01406 (Option 98) Angled: -----
6		BS: United Kingdom	250 V at 6 A Black 2 m (6 ft)	Straight: A01407 (Option 99) Angled: A01417

CLASS 1 LASER PRODUCT Labels

This product is the class 1 laser product.

The following warning labels are packaged with accessories.

INTERNATIONAL LASER WARNING LABELS		
JAPANESE	FOR: JAPAN	
		
ENGLISH	FOR: UK NORWAY SWEDEN DENMARK BELGIUM NETHERLANDS	
		
FRENCH	FOR: FRANCE BELGIUM SWITZERLAND	
		
GERMAN	FOR: GERMANY BELGIUM SWITZERLAND AUSTRIA	
		
SPANISH	FOR: SPAIN	
		
ITALIAN	FOR: ITALY SWITZERLAND	
		
FINNISH	FOR: FINLAND	
		
<p>PLEASE NOTE SWITZERLAND MAY REQUIRE FRENCH, GERMAN, OR ITALIAN LABELING. BELGIUM MAY REQUIRE ENGLISH, FRENCH, OR GERMAN LABELING.</p>		
MNS-E0168A		

Put a label on the place shown in the following illustration according to the useful language in your country.

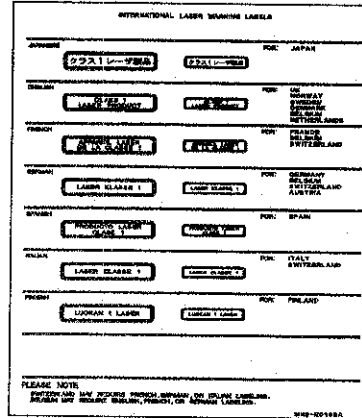

Put it on here.

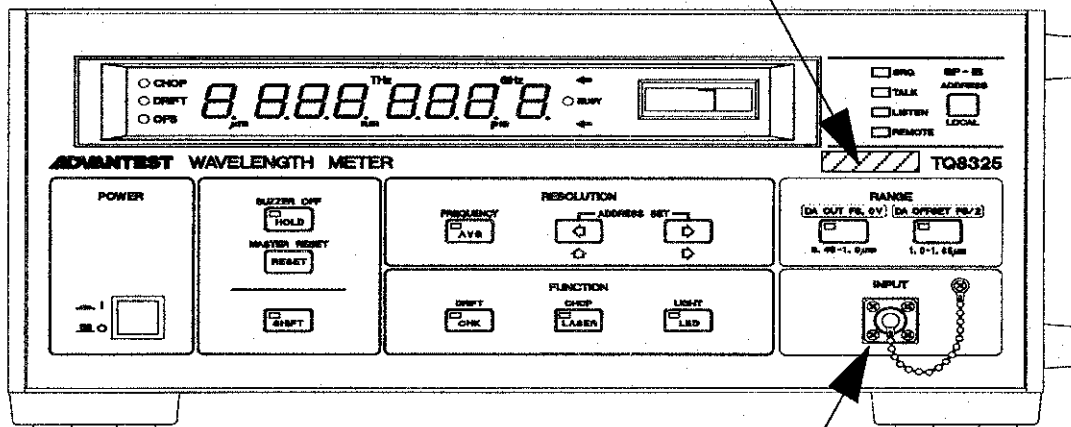

TQ8325 Front view

When the fiber is not inserted, cover the terminal with the cap to prevent the dust and the laser radiation from the inside of TQ8325.

CAUTION

Performance of procedures other than those specified herein may result in hazardous radiation exposure.

TQ8325
DIGITAL OPTICAL WAVELENGTH METER
INSTRUCTION MANUAL

Table of Contents

TABLE OF CONTENTS

1. INTRODUCTION	1 - 1
1.1 HOW TO USE THIS INSTRUCTION MANUAL	1 - 1
1.2 TQ8325 PRODUCT OVERVIEW	1 - 2
1.3 OPERATING ENVIRONMENT	1 - 3
1.4 BEFORE USING	1 - 4
1.4.1 Visual Check and Accessory Check	1 - 4
1.4.2 Fuse Check and Replacement	1 - 5
1.4.3 Expendables	1 - 5
1.4.4 Cleaning the input optical connector	1 - 6
1.5 MAINTENANCE	1 - 8
1.6 STORAGE AND TRANSPORTATION	1 - 9
2. OPERATING PROCEDURES	2 - 1
2.1 PANEL DESCRIPTION	2 - 1
2.1.1 Front Panel	2 - 1
2.1.2 Rear panel	2 - 4
2.2 SETUP (PREPARATIONS FOR USE)	2 - 6
2.2.1 Power On/Master Reset	2 - 6
2.2.2 Operation Check by the Self-check Function	2 - 9
2.3 WAVELENGTH MEASUREMENT	2 - 10
2.3.1 Measurement Procedure After Setup	2 - 10
2.3.2 Ratings During Wavelength Measurement	2 - 12
2.4 MEASURING THE FREQUENCY	2 - 13
2.4.1 Changing Wavelength Measurement to Frequency Measurement ..	2 - 13
2.4.2 Specification of Frequency Measurement	2 - 13
2.5 MEASURING THE DEVIATION	2 - 15
2.5.1 Measuring the deviation	2 - 15
2.5.2 GPIB Deviation Measurement	2 - 15
2.6 MEASUREMENT OF HIGH FREQUENCY INTENSITY MODULATED LIGHT AND CHOP LIGHT	2 - 16
2.6.1 Wavelength of High Frequency Intensity Modulated Light and Measurement Procedure	2 - 16
2.6.2 Measurement Ratings for High Frequency Modulated Light Wavelength	2 - 16
2.6.3 Measurement of CHOP Light	2 - 16
2.7 USEFUL FUNCTIONS FOR MEASUREMENT	2 - 18
2.7.1 HOLD	2 - 18
2.7.2 RESET	2 - 18
2.7.3 AVERAGE	2 - 18
2.7.4 RESOLUTION key Operation Method	2 - 18
2.8 D/A OUTPUT	2 - 21
2.8.1 Performance	2 - 21
2.8.2 Relationship between Display and Output Voltage	2 - 21
2.8.3 Key Operations Relating to D/A OUT	2 - 21
2.9 AUXILIARY KEY FUNCTIONS	2 - 23
2.9.1 Buzzer On/Off	2 - 23
2.9.2 Level Meter Illumination On/Off Setting	2 - 23

TQ8325
DIGITAL OPTICAL WAVELENGTH METER
INSTRUCTION MANUAL

Table of Contents

2.10 MESSAGES	2 - 24
2.10.1 Displayed Messages	2 - 24
2.10.2 Error Messages	2 - 25
3. GPIB CONNECTION AND PROGRAMMING	3 - 1
3.1 OUTLINE	3 - 1
3.2 OUTLINE OF GPIB	3 - 2
3.3 SPECIFICATIONS	3 - 4
3.3.1 Use of GPIB	3 - 4
3.4 GPIB HANDLING METHOD	3 - 7
3.4.1 Connection to Devices	3 - 7
3.5 GPIB ADDRESS SETTING	3 - 8
3.5.1 LOCAL Key	3 - 8
3.5.2 Address Setting Mode	3 - 8
3.6 TALKER FORMAT	3 - 11
3.6.1 Talker Format	3 - 11
3.6.2 Header	3 - 12
3.7 PROGRAM CODES	3 - 13
3.8 SERVICE REQUEST	3 - 15
3.9 GPIB PROGRAMMING EXAMPLES	3 - 16
4. THEORY OF OPERATION	4 - 1
5. SPECIFICATIONS	5 - 1
6. PERFORMANCE TEST	6 - 1
6.1 NECESSARY EQUIPMENTS	6 - 2
6.2 ITEMS OF PERFORMANCE TEST	6 - 3
6.3 TEST METHOD	6 - 4

TQ8325
DIGITAL OPTICAL WAVELENGTH METER
INSTRUCTION MANUAL

List of Figures

LIST OF FIGURES

Figure No.	Title	Page
1 - 1	Confirming the fuse	1 - 5
2 - 1	Relationship between spectral width and	2 - 11
	measurement resolution	
3 - 1	Outline of GPIB	3 - 3
3 - 2	GPIB connector pin layout	3 - 5
4 - 1	Optical subsystem function	4 - 1
5 - 1	Relationship between spectral width and	5 - 2
	measurement resolution	

TQ8325
DIGITAL OPTICAL WAVELENGTH METER
INSTRUCTION MANUAL

List of Tables

LIST OF TABLES

Table No.	Title	Page
1 - 1	Standard accessories	1 - 4
3 - 1	Interface functions	3 - 5
3 - 2	Standard bus cables (optional)	3 - 7
6 - 1	Necessary equipments	6 - 2
6 - 2	Performance test specification	6 - 3

TQ8325
DIGITAL OPTICAL WAVELENGTH METER
INSTRUCTION MANUAL

1.1 How to Use This Instruction Manual

1. INTRODUCTION

This chapter explains how to use this manual, outlines the meter's functions, and explains the procedures required before measurements are taken.

Before taking measurements, read this chapter.

1.1 HOW TO USE THIS INSTRUCTION MANUAL

This manual describes the functions of the TQ8325 meter from basic principles to applied functions.

Users who have already read this manual can refer to a specific chapter for information. Users not familiar with the TQ8325 should read the entire manual before using it.

TQ8325
DIGITAL OPTICAL WAVELENGTH METER
INSTRUCTION MANUAL

1.2 TQ8325 Product Overview

1.2 TQ8325 PRODUCT OVERVIEW

Optical wavelength meter TQ8325 enables high-precision measurement of laser and light emitting diode wavelengths and frequency. Its characteristics are described below.

[Characteristics]

- ① Measurement of wavelengths from 0.48 μm to 1.6 μm and frequency from 187THz to 625THz without replacing the input connector is possible.
- ② Measurements have an accuracy of ± 5 ppm and high resolution of resolution 0.001 nm/100MHz.
- ③ Displays the difference between the result of the first measurement of deviation and that of the second measurement. Can measure the optical frequency and shifted waveform.
- ④ Measurement time is at 5 measurements/s.
The fiber connector input method is used to enable easy input of the light to be measured.
- ⑤ GPIB and D/A conversion analog output is standard.
- ⑥ The conditions of panel are backed up from the battery.

TQ8325
DIGITAL OPTICAL WAVELENGTH METER
INSTRUCTION MANUAL

1.3 Operating Environment

1.3 OPERATING ENVIRONMENT

(1) AC power source

Be sure to use the supplied power cable to operate the TQ8325 by an AC power source. Comply with the set displayed on the rear panel. AC power source shall be used within the range of the frequency of 48 Hz to 66 Hz.

(2) Installation

The socket-outlet shall be installed near the equipment and shall be easily accessible.

(3) Ambient conditions for use

Though the ambient temperature for using the TQ8325 is $+10^{\circ}\text{C}$ to $+40^{\circ}\text{C}$ and the humidity 85% or less, accuracy is guaranteed only for a temperature of $25\pm 10^{\circ}\text{C}$. Do not expose the TQ8325 to direct sunlight, and keep it in a well-ventilated room.

(4) Handling

Do not drop the TQ8325 or subject it to mechanical shock.

(5) How to use

Do not lay the portable TQ8325 on its side or stand it vertically when use it. Do not use the TQ8325 in a place subject to vibration.

(6) Cleaning

To clean the TQ8325, observe the following precaution.

CAUTION

To maintain or clean the device, do not use any solvent which may degrade plastics (organic solvent such as benzene, toluene and acetone).

TQ8325
DIGITAL OPTICAL WAVELENGTH METER
INSTRUCTION MANUAL

1.4 Before Using

1.4 BEFORE USING

1.4.1 Visual Check and Accessory Check

Check to see if the TQ8325 has been scratched or otherwise damaged. Confirm that the standard accessories are as described in the table below. If you find any scratches, dents, other damage, or if any parts are missing, contact the nearest ADVANTEST dealer. The addresses and telephone numbers of dealers are listed at the back of this manual.

Table 1-1 Standard accessories

Name	Type name	Quantity	Remarks
Power cable	*1	1	
Fuse	2181.25	2	Opt.00 : For 100 VAC specification
	218.630		Opt.40 : For 200 VAC specification
Instruction manual	E8325	1	English version
Label for Class 1 Laser Product	MNS-E0168	1	

*1 : ADVANTEST provides the power cables for each country.

Note: Order the addition of the accessory etc. with type name.

TQ8325
DIGITAL OPTICAL WAVELENGTH METER
INSTRUCTION MANUAL

1.4 Before Using

1.4.2 Fuse Check and Replacement

Procedure of checking or confirming a fuse is described below:

- ① Remove the power cable from the AC line connector.
- ② Turn the fuse holder counterclockwise with pushing it using a minus screwdriver. When the fuse holder goes out a little, pull out the fuse holder with your hand.
- ③ Confirm that the fuse has blown and replace it with a new one.
- ④ Insert the new fuse into the fuse holder then install the power cable to the AC power connector.

CAUTION

1. Be sure to replace with a fuse of the correct rating. If not, the TQ8325 may be damaged.
2. Be sure to use the fuse applied to the currently-set voltage.

	Voltage	Fuse specifications
Opt.00	100 to 120 V	Slow-blow T 1.25 A/250 V
Opt.40	220 to 240 V	Slow-blow T 0.63 A/250 V

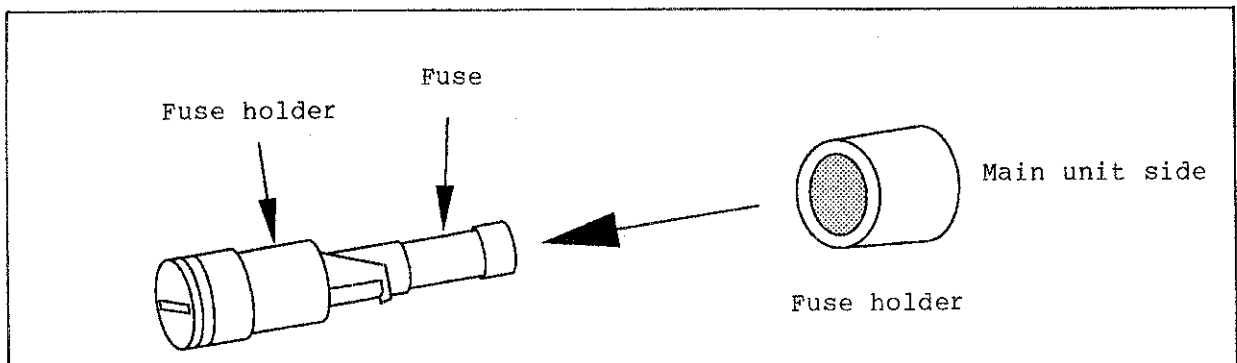

Figure 1-1 Confirming the fuse

1.4.3 Expendables

The following part of the analyzer must be changed periodically.

Parts	Life time	Conditions
Laser tube	10000 hours	After powering on, a message of "Err rE" is displayed to indicate self diagnosis failure. In this case, contact the sales dealer or the support office.

TQ8325
DIGITAL OPTICAL WAVELENGTH METER
INSTRUCTION MANUAL

1.4 Before Using

1.4.4 Cleaning the input optical connector

If the end of the internal optical connector in the optical input section of the analyzer is not clean, the input sensitivity may be degraded.

When connecting an optical connector to the analyzer, confirm that the end is sufficiently clean. Also, do not forget to clean the end of the internal optical connector in the optical input section of the analyzer.

- Cleaning the end of the internal optical connector

(1) Removing the optical input section

- ① Remove screws 1 and 2 using a 2 mm screwdriver.

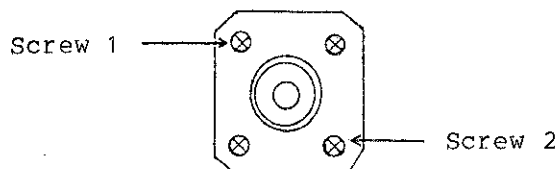

- ② Slowly pull the optical input section out. (Pull out about 3 to 5 cm.)

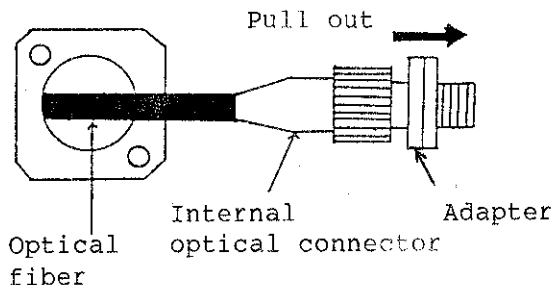

NOTE

Take care not to break the fiber.

(2) Cleaning the end of the internal optical connector

- ③ Remove the connector from the adapter and clean the end and sides of the connector ferrule using an absorbent gauze moistened with alcohol.

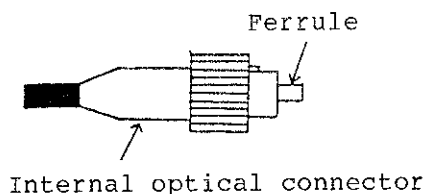

TQ8325
DIGITAL OPTICAL WAVELENGTH METER
INSTRUCTION MANUAL

1.4 Before Using

- ④ Lightly dab the end of the connector with the alcohol-moistened gauze and wipe off excess alcohol with a piece of dry gauze.

NOTE

Take care not to rub the fiber too vigorously to avoid scratching the surface.

(3) After cleaning

- ⑤ After drying the end of the fiber, mount the internal optical connector on the adapter and slowly set it in its original position. Fix the adapter with the two screws.

TQ8325
DIGITAL OPTICAL WAVELENGTH METER
INSTRUCTION MANUAL

1.5 Maintenance

1.5 MAINTENANCE

CAUTION

No operator serviceable parts inside. Servicing to be provided by trained individuals.

For the maintenance or the inspection of TQ8325's inside or the replacement of various parts other than fuse, contact your nearest ADVANTEST dealer.

TQ8325
DIGITAL OPTICAL WAVELENGTH METER
INSTRUCTION MANUAL

1.6 Storage and Transportation

1.6 STORAGE AND TRANSPORTATION

(1) Storing the TQ8325

When you do not use the TQ8325 for a long time, cover it with vinyl, or put it in a corrugated cardboard box and store the box in a dry place that is not exposed to direct sunlight.

(2) Transporting the TQ8325

To move the TQ8325, pack it in the container in which it was shipped or a similar container.
If the original shipping container is no longer available, pack the TQ8325 as follows:

- ① Cover TQ8325 with plastic.
- ② Put shock material to absorb shock in a corrugated cardboard box (thickness: at least 5 mm) and roll the TQ8325 in shock-absorbing material.
- ③ Put accessories in the cardboard box and cushion these with shock-absorbing material. Close the cover of the box and bind it securely.

TQ8325
DIGITAL OPTICAL WAVELENGTH METER
INSTRUCTION MANUAL

2.1 Panel Description



2. OPERATING PROCEDURES

2.1 PANEL DESCRIPTION

2.1.1 Front Panel

- ① POWER switch
- ② SHIFT key
 - Press this key, and the mode is changed to the SHIFT mode. The LED in the key lights. The blue functions on keys are enabled.
 - Press any key to release the SHIFT key mode, and the LED in the key goes off.
- ③ HOLD/BUZZER OFF key
 - This key holds the contents of display.
 - Repress this key to release the held state.
 - This key turns on or off the buzzer in the SHIFT key mode.
- ④ RESET/MASTER RESET key
 - This key clears the result of measurement.
 - This key enables the single measurement when the display is held.
 - This key updates reference data when the deviation is measured.
 - This key enables master reset in the SHIFT mode and puts the equipment into the initial state.

[RESOLUTION]

- ⑤ AVG/FREQUENCY key
 - This key displays the average of 10 measurements in the averaging mode.
 - Repress this key to release the averaging mode.
 - This key changes frequency measurement or waveform measurement in the SHIFT key mode.
- ⑥  key
 - This key reduces the number of digits displaying resolution one by one.
 - This key changes the digit blinking in the GPIB ADDRESS set mode.
- ⑦  key
 - This key increases the number of digits displaying resolution one by one.
 - This key moves the digit changing in the GPIB ADDRESS set mode.

TQ8325
DIGITAL OPTICAL WAVELENGTH METER
INSTRUCTION MANUAL

2.1 Panel Description

[FUNCTION]

- ⑧ CHK/DRIFT key
 - This key checks whether the CHECK function and this equipment operate normally.
 - Set other functions such as LASER and LED to release the CHECK function.
 - Deviation measurement is enabled in the SHIFT key mode.
 - Repress the SHIFT + CHK key to release deviation measurement.
- ⑨ LASER/CHOP key
 - LASER measurement mode
 - Set other functions such as CHK and LED to release the LASER mode.
 - When this key is pressed in the SHIFT key mode, the mode is changed to the CHOP optical measurement mode.
 - Set other functions such as CHK and LED to release the CHOP optical measurement mode.
- ⑩ LED/LIGHT key
 - LED measurement mode
 - Set other functions such as CHK and LASER to release the LED measurement mode.
 - This key turns on or off the level meter lamp in the SHIFT key mode.

[RANGE]

- ⑪ 0.48 μm to 1 μm /DA OUT FS. 0V key
 - This key enables the waveform measurement of 0.48 μm to 1 μm (short wavelength).
 - This key sets the D/A OUT output to 0V/FULL SCALL(1V) in the SHIFT key mode. Use the key when connecting the D/A OUT output to the time recorder.
 - Repress the SHIFT + 0.48 μm to 1 μm key to reset the D/A OUT output.
- ⑫ 1.0 μm to 1.6 μm /DA OFFSET
 - This key enables the waveform measurement of 1.0 μm to 1.6 μm (long wavelength).
 - This key applies the 500 mV offset to the D/A output in the SHIFT key mode.
 - Repress the SHIFT + 1.0 μm to 1.6 μm key to reset the D/A OUT.
- ⑬ LOCAL/ADDRESS key
 - When this key is controlled by GPIB, it release the remote state.
 - When this key is pressed in the SHIFT key mode, the mode is changed to the ADDRESS set mode.
 - Repress the SHIFT + LOCAL key to release the ADDRESS set mode.

TQ8325
DIGITAL OPTICAL WAVELENGTH METER
INSTRUCTION MANUAL

2.1 Panel Description

- ⑭ GPIB status monitor
- This monitor indicates the state of the device when it is controlled by GPIB.
 - SRQ indicates the state sending a service request to the controller. TALK indicates the talker state to send data. LISTEN indicates the listener state to receive data. REMOTE indicates the remote state controlled externally.

[DISPLAY]

- ⑮ Level meter
- Monitors the strength of input light.

CAUTION

When the needle of the level meter points the red section, adjust the input light level so that the needle may point the green section before starting a measurement. If not, a wavelength (frequency) may not be measured or the display may be not stable.

- ⑯ Display
- Displays the result of measurement by 8-digit LED.
- ⑰ CHOP indicator
- Indicates the state of CHOP optical measurement mode.
- ⑱ DRIFT indicator
- Indicates the state of deviation measurement mode.
- ⑲ OPS indicator
- Indicates the offset of D/A OUTPUT.
- ⑳ BUSY indicator
- Indicates that this device performs measurement. If the condition for input is incorrect, this indicator may not light.
- ㉑ Frequency indicator
- Indicates the frequency measurement mode. The unit is THz and GHz.
- ㉒ Wavelength indicator
- Indicates the wavelength measurement mode. The unit is μm , nm, and pm.

TQ8325
DIGITAL OPTICAL WAVELENGTH METER
INSTRUCTION MANUAL

2.1 Panel Description

2.1.2 Rear panel

- ① D/A OUT terminal
Analog conversion voltage of a displayed value is output from this BNC connector.

- ② GPIB connector
The GPIB connector is connected to an external controller or plotter through a GPIB cable.

- ③ AC LINE connector
The AC LINE connector is for the power cable.
The round prong goes to ground.

- ④ Functional ground

TQ8325
DIGITAL OPTICAL WAVELENGTH METER
INSTRUCTION MANUAL

2.1 Panel Description

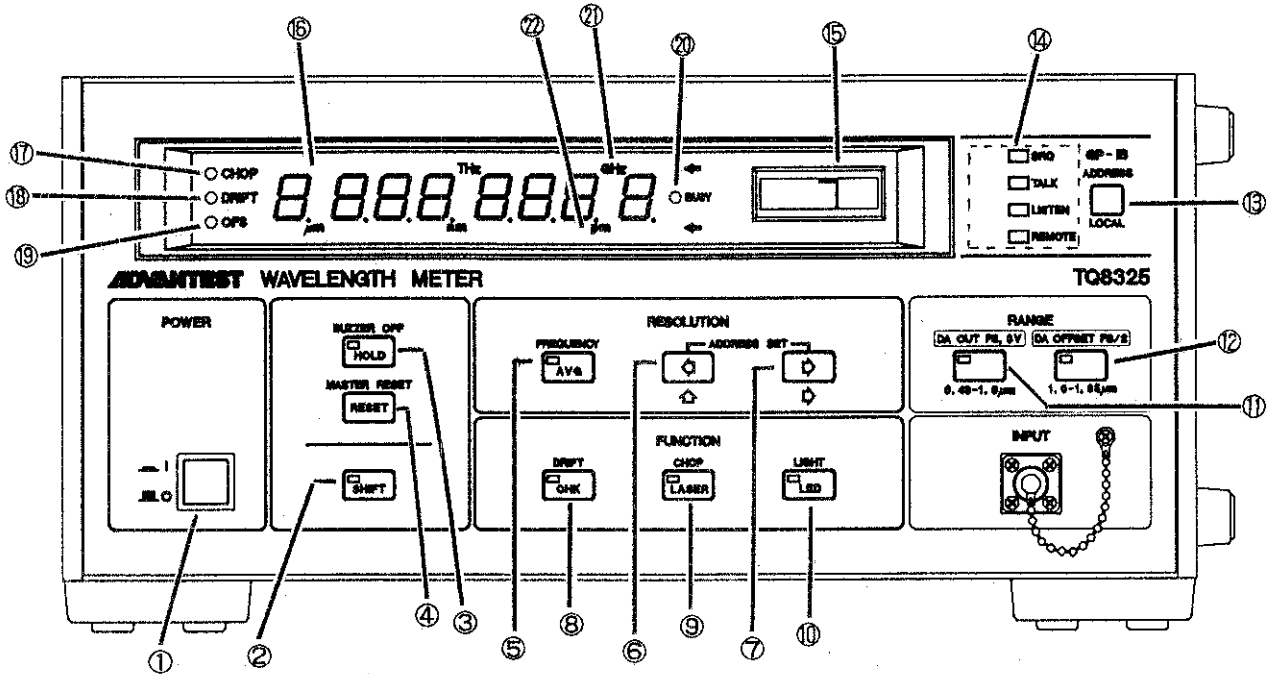

Front panel

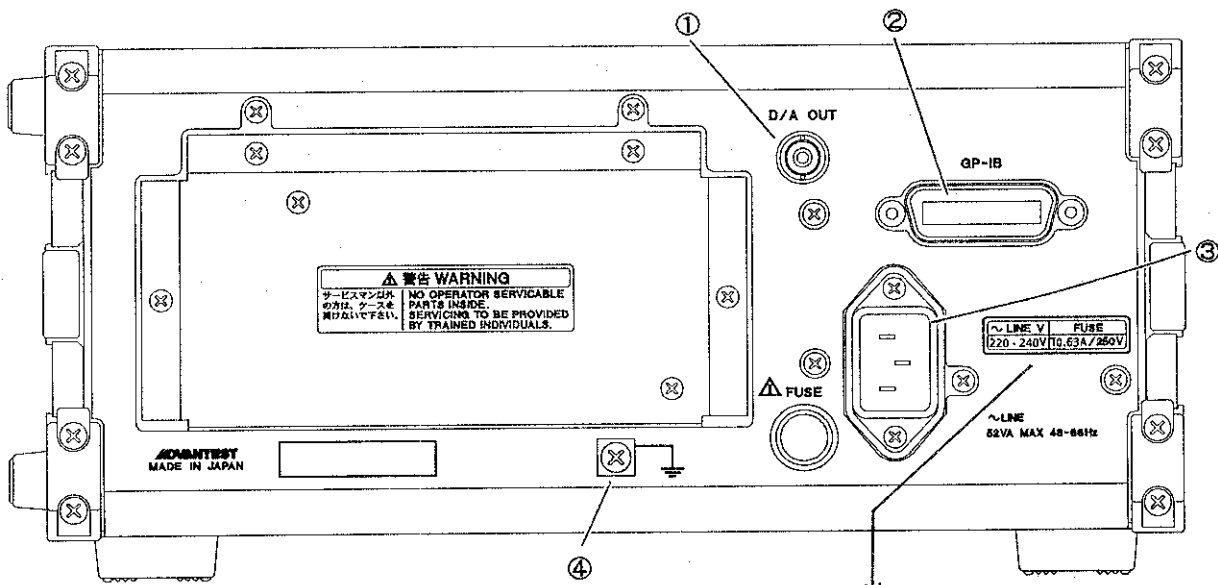

Rear panel

~LINE V	FUSE	
100 - 120V	T1.25A/250V	(Opt. 00)
~LINE V	FUSE	
220 - 240V	T0.63A/250V	(Opt. 40)

TQ8325
DIGITAL OPTICAL WAVELENGTH METER
INSTRUCTION MANUAL

2.2 Setup (Preparations for Use)

2.2 SETUP (PREPARATIONS FOR USE)

2.2.1 Power On/Master Reset

- (1) Confirm that the power voltage is within the range of the voltage displayed on the rear panel and that the POWER switch on the front panel is off. Connect one end of the power cable to the AC LINE connector at the rear of the TQ8325 and the other end to a power receptacle. If connecting an adapter to a 2-hole receptacle, connect a wire from the adapter or the ground terminal on the rear panel to ground.
- (2) When the POWER switch is set to ON, the self-diagnostic function is executed automatically and all segments of all digits and all LED lamps are turned on for one minute. Check the lamps visually.
- (3) After all digits have been turned on, ROM, RAM, and the internal circuits of the TQ8325 are checked automatically. If a failure is detected, an error message is displayed. For details on error messages, see Section 2.10.2.
- (4) If the TQ8325 is operating normally, the panel key settings after power is turned on are restored to what they were just before power was turned off.
The display on the front panel after power is turned on is shown below.

TQ8325
DIGITAL OPTICAL WAVELENGTH METER
INSTRUCTION MANUAL

2.2 Setup (Preparations for Use)

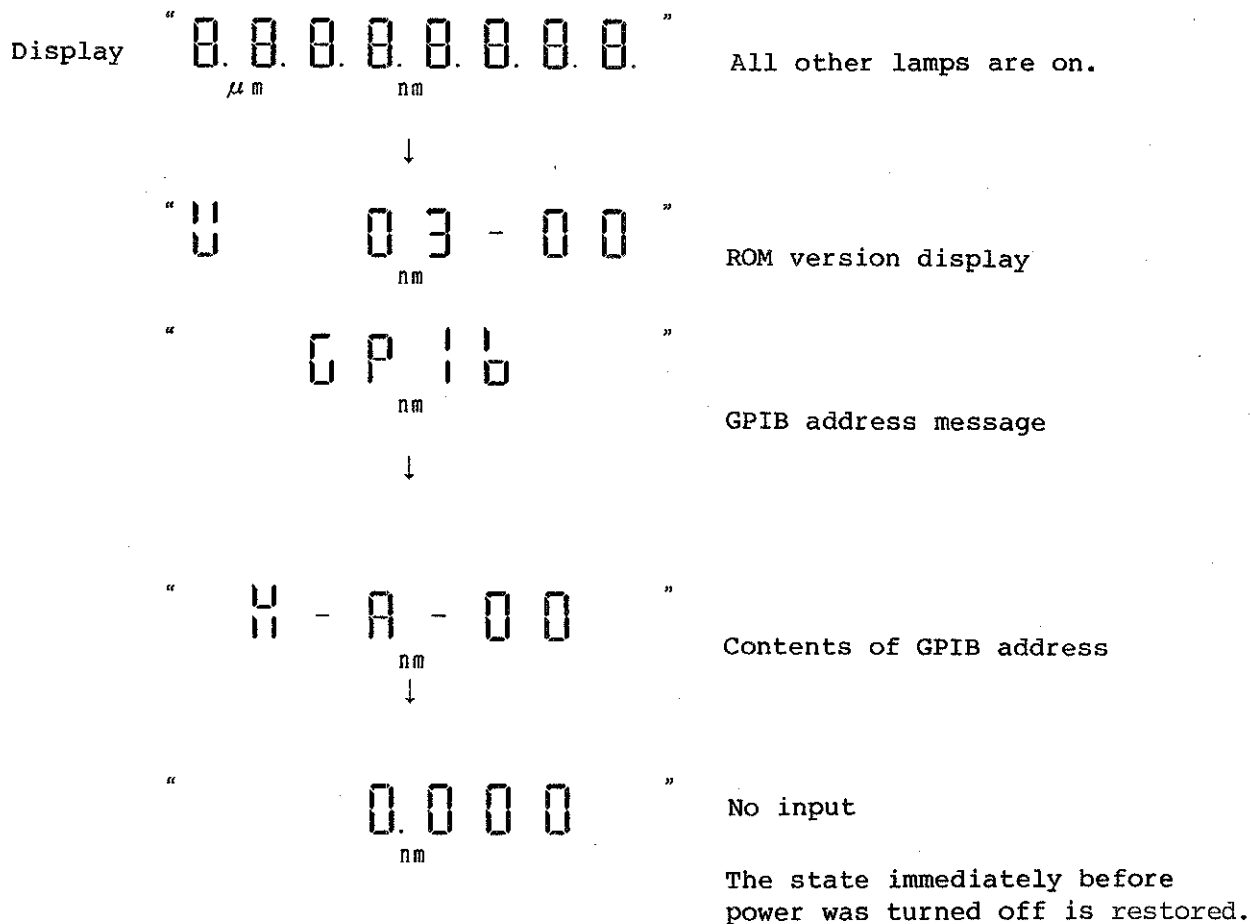

(5) Master reset

To initialize the settings of the keys on the front panel, press the

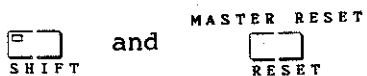

keys. The key settings and the internal

data memory are cleared for initialization. The address of the TQ8325 in the GPIB system is not changed. The initial state set by MASTER RESET and the panel setting are shown below.

TQ8325
DIGITAL OPTICAL WAVELENGTH METER
INSTRUCTION MANUAL

2.2 Setup (Preparations for Use)

Panel display after master reset

Display " 0 . 0 . 0 . 0 . 0 . 0 . 0 . 0 " All other lamps are on.
 μm nm



" 0 0 3 - 0 0 " ROM version display
 nm

" 0 P 1 6 " GPIB address message
 nm



" 4 - A - 0 0 " Contents of GPIB address
 nm



" 0 . 0 0 0 " (No input)
 nm

	Measure wavelength	} Initialization
MODE	OFF	
DRIFT	OFF	
OFS	OFF	
Resolution	0.001nm	
FUNCTION	LASER	
RANGE	0.48 μm to 1 μm	
AVG	OFF (Lamp off)	
HOLD	OFF (Lamp off)	
BUZZER	ON	
Level meter illumination	OFF	

TQ8325
DIGITAL OPTICAL WAVELENGTH METER
INSTRUCTION MANUAL

2.2 Setup (Preparations for Use)

2.2.2 Operation Check by the Self-check Function

Perform the following operations to check whether the TQ8325 is operating normally:

- (1) Confirm that the self-diagnostics function is executed after the POWER switch is turned on. (See (2) and (3) in Section 2.2.1.)
- (2) Confirm that the initial state is set after the master reset operation. (See Section 2.2.1.)
- (3) Press the  key to check whether the TQ8325 internal circuits are operating normally. The following is displayed:

" 1 000.000 " OR " 1 000.00 "

μm nm μm nm

Note:

The level meter needle deflects to the green zone.

A display other than the above indicates that the TQ8325 is malfunctioning. Contact the nearest ADVANTEST dealer.

To enter the measurement mode when resetting the self-check function,



press the  or  key.

TQ8325
DIGITAL OPTICAL WAVELENGTH METER
INSTRUCTION MANUAL

2.3 Wavelength Measurement

2.3 WAVELENGTH MEASUREMENT





2.3.1 Measurement Procedure After Setup

- ① When measuring light with a short wavelength (0.48 μm to 1 μm), press the  key. For a long wavelength (1 μm to 1.6 μm), press the  key. When the  key is pressed, the following is displayed:

“ 0.000 ” No input
nm

- When the  key is pressed, the following is displayed:

“ 0.000.000 ” No input
 μm nm

- ② When measuring a laser beam (light with a narrow spectral width), press the  key. For a LED light (light with a wide spectral width), press the  key.
- ③ Input the light to be measured to the front panel optical connector through a fiber cable. The BUSY lamp goes on and off and the measured values are displayed.
- ④ Confirm the deflection of the level meter needle. If the level meter needle deflects to the orange zone at the left, measured values may be incorrect because of insufficient input level. Increase the input level.
- ⑤ If the measured values are scattered, press the  key to display the transitional average value of 10 measurements. Stable measured values will then be obtained.
- ⑥ If measured values are hard to read because of variations in the wavelengths of input light, press the  key to blank out the lower digits. An appropriate resolution is displayed.

TQ8325
DIGITAL OPTICAL WAVELENGTH METER
INSTRUCTION MANUAL

2.3 Wavelength Measurement

- ⑦ During measurement, "■" may be displayed in the digit position in the display area. The following is an example of measuring a laser diode with a spectral width of 500 GHz:

" 1.323. 48.■ "

μm nm

This is done by the auto resolution function. When the spectral width of the input light is wider for the resolution set with the $\left[\begin{array}{c} \square \\ \updownarrow \end{array} \right]$ and $\left[\begin{array}{c} \square \\ \updownarrow \end{array} \right]$ keys, optimum resolution is automatically displayed. The digits that cannot be measured are displayed as "■".

Figure 2-1 shows the relationship between spectral width (frequency or wavelength) and measurement resolution.

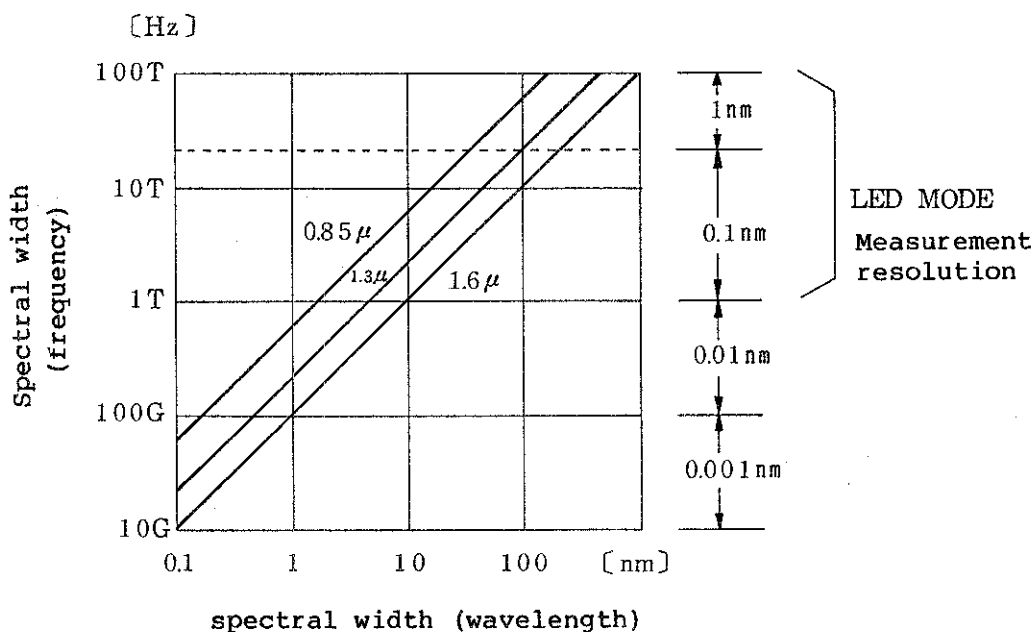

Figure 2-1 Relationship between spectral width and measurement resolution

With the above operations, the wavelength of the input light can be measured.

TQ8325
DIGITAL OPTICAL WAVELENGTH METER
INSTRUCTION MANUAL

2.3 Wavelength Measurement

2.3.2 Ratings During Wavelength Measurement

The ratings for the laser measurement mode and LED measurement mode are shown below.

Laser measurement mode
[Ratings]

Measurement wavelength range	0.48 μm to 1.0 μm (Short wavelength band) 1.0 μm to 1.6 μm (Long wavelength band)
Measurement input level range	-15 dBm to +3 dBm (0.48 μm to 0.6 μm) -23 dBm to +3 dBm (0.6 μm to 1.6 μm)
Spectral width	1 THz or less
Measurement resolution	0.001nm to 1nm

LED measurement mode
[Ratings]

Measurement wavelength range	0.48 μm to 1.0 μm (Short wavelength band) 1.0 μm to 1.6 μm (Long wavelength band)
Measurement input level range	-15 dBm to +3 dBm (0.48 μm to 0.6 μm) -23 dBm to +3 dBm (0.6 μm to 1.6 μm)
Spectral width	1 THz to 100 THz
Measurement resolution	0.1nm to 1nm

Note:

Input light must not exceed the input level range in either the LASER or LED measurement mode.

TQ8325
DIGITAL OPTICAL WAVELENGTH METER
INSTRUCTION MANUAL



2.4 Measuring the Frequency

2.4 MEASURING THE FREQUENCY

2.4.1 Changing Wavelength Measurement to Frequency Measurement

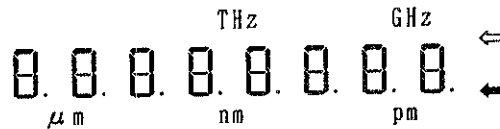
- ① If the lower arrow lights, wavelength measurement is enabled.



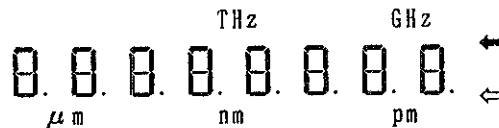

- ② Press the  and  keys.

The upper arrow lights.



The unit is THz and GHz.

- ③ Repress the  and  keys to return to wavelength measurement.

- ④ The method of measurement is the same as wavelength measurement.

Note: The CHECK function is disabled for frequency measurement. Return to wavelength measurement.

2.4.2 Specification of Frequency Measurement

The following lists the specifications of LASER measurement mode and LED measurement mode.

LASER measurement mode

[Specification]

Measuring frequency range: 187THz to 300THz (long wavelength region)
300THz to 625THz (short wavelength region)

Measuring input level: -15dBm to +3dBm (500THz to 625THz)
-23dBm to +3dBm (187THz to 500THz)

Spectral width: Less than about 1THz

Measuring resolution: 0.1GHz to 1THz

TQ8325
DIGITAL OPTICAL WAVELENGTH METER
INSTRUCTION MANUAL

2.4 Measuring the Frequency

LED measurement mode

[Specification]

Measuring frequency range: 187THz to 300THz (long wavelength region)
300THz to 625THz (short wavelength region)

Measuring input level: -15dBm to +3dBm (500THz to 625THz)
-23dBm to +3dBm (187THz to 500THz)

Spectral width: Approx. 1THz to 100THz

Measuring resolution: 10GHz to 1THz

NOTE

The input light does not exceed the measuring input level in the LASER measurement mode and LED measurement mode.

TQ8325
DIGITAL OPTICAL WAVELENGTH METER
INSTRUCTION MANUAL

2.5 Measuring the Deviation

2.5 MEASURING THE DEVIATION

2.5.1 Measuring the deviation



Press the  key and display the difference between the first measured value and the next measured value.

- ① Press the  and  keys.

The LED of the DRIFT indicator lights. \Rightarrow ● DRIFT
This operation allows the deviation to be measured.

- ② Press the  key to change the reference value.

Remeasure the reference value.

- ③ Press the  and  keys to release the measurement of deviation

The LED of DRIFT indicator lights. \Rightarrow ○ DRIFT

2.5.2 GPIB Deviation Measurement

When the controller is connected to measure the deviation, the arbitrary reference value can be set.

- ① Example:
To set the reference value to 1.234567 μm , input the following values through the controller.

```
OUTPUT 701;"RF2"  
OUTPUT 701;"RD12345670"
```

To measure the wavelength and frequency, input the eight-digit integer.

- ② To set measure value as a reference, input the following value.

```
OUTPUT 701;"RF1"
```

After the command is accepted, measured value is referred.

- ③ To release the measurement of deviation, input the following value.

```
OUTPUT 701;"RF0"
```

Return to wavelength measurement or frequency measurement mode.

TQ8325
DIGITAL OPTICAL WAVELENGTH METER
INSTRUCTION MANUAL

2.6 Measurement of
High Frequency Intensity Modulated Light and CHOP Light

2.6 MEASUREMENT OF HIGH FREQUENCY INTENSITY MODULATED LIGHT AND CHOP LIGHT

The TQ8325 can measure wavelengths of intensity modulated light of 3 MHz or above and CHOP light of 1 Hz to 500 Hz. The measurement procedure is explained below.

2.6.1 Wavelength of High Frequency Intensity Modulated Light and Measurement Procedure

Wavelengths of intensity modulated light of 3 MHz or above can be measured the same way as described in Section 2.3. The sensitivity of the average input power is proportional to the duty; that is, the sensitivity for pulse intensity modulated light with a duty ratio 50% is lowered by 3 dB.

Note: Even though the input light is a modulated light of 3 MHz or above, if a frequency component of 3 MHz or less included in the modulated light, the measurement value becomes unstable.

2.6.2 Measurement Ratings for High Frequency Modulated Light Wavelength

[Ratings]



Modulation frequency range	3 MHz or above
Sensitivity	-15 dBm average power (0.48 μm to 0.6 μm) -23 dBm average power (0.6 μm to 1.6 μm)
Maximum input level	+3 dBm peak power (0.48 μm to 1.6 μm)

2.6.3 Measurement of CHOP Light

The TQ8325 can measure the wavelength of a laser that has been chopped electrically or mechanically.

- (1) Press the  and  keys.

The CHOP lamp comes on and the CHOP light measurement mode is activated.

- (2) When the wavelength of the light to be measured is in the short wavelength band, 0.48 μm to 1.0 μm , press the  key. When it is in the long wavelength band, 1.0 μm to 1.6 μm , press the  key.

TQ8325
DIGITAL OPTICAL WAVELENGTH METER
INSTRUCTION MANUAL

2.6 Measurement of
High Frequency Intensity Modulated Light and CHOP Light

- (3) Input CHOP light and confirm that the level meter needle is in the green area. If the needle is in the red area, increase the input sensitivity until the needle is in the green area.
If the setting resolution is too high for the pulse width, the

measured values are not displayed. Press the  key to reduce the resolution.

The resolution in the CHOP light measurement mode is 1THz to 1GHz for frequency, 1 nm to 0.01 nm for wavelength.

Measurable CHOP light frequency range : 1 to 500 Hz

Maximum input level in CHOP light measurement mode:

-5 dBm peak power (for 0.85 μm)

-5 dBm peak power (for 1.3 μm)

- (4) To reset the CHOP light measurement mode, press the  key.

TQ8325
DIGITAL OPTICAL WAVELENGTH METER
INSTRUCTION MANUAL

2.7 Useful Functions for Measurement

2.7 USEFUL FUNCTIONS FOR MEASUREMENT

2.7.1 HOLD



When the  key is pressed, the lamp on the key comes on, measurement stops, and the display is frozen. When the key is pressed again, the lamp on the key goes off and the hold state is released.

2.7.2 RESET

When the  key is pressed, the measured data stored in memory is cleared. The panel setting is not changed. When the key is pressed in the hold state, measurement is performed only once and the display frozen. When the key is pressed in both the hold state and the average mode, the average value for 10 measurements is displayed and maintained.

2.7.3 AVERAGE

When the  key is pressed, the lamp on the key comes on and the average mode is set to display the transitional average value of 10 measurements.

The hold state is maintained from the time the  key is pressed until 10 measurements have been completed. After the 10th measurement has been completed, the hold state is released and the transitional average value is displayed. When the  key is pressed in the average mode, the lamp on the key goes off and the average mode is reset.

When the  key is pressed in the average mode, the previously measured data is cleared and

"A" is displayed. When the next 10 measurements have been completed, the transitional average value is displayed. During the display, the lamp on the key is on.

2.7.4 RESOLUTION key Operation Method

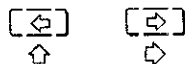

TQ8325
DIGITAL OPTICAL WAVELENGTH METER
INSTRUCTION MANUAL

2.7 Useful Functions for Measurement

These keys set the measurement resolution. Since the up/down method is used, the user can set resolution by viewing the display.

Each time the  key is pressed once, the display is decreased by one digit.

Each time the  key is pressed once, the display is increased by one digit.

When the laser measurement mode is set, a resolution of 1 nm to 1/1000 nm can be set with these keys.

When the LED measurement mode is set, these keys can set a resolution of 1 nm to 1/10 nm.

When the  key is set, pressing the RESOLUTION keys has no effect.

If the upper limit of the range of resolutions that can be set with the RESOLUTION keys is exceeded,

"UP End"

is displayed and, in the buzzer-on state, the buzzer sounds. If the lower limit is exceeded,

"dn End"

is displayed and, in the buzzer-on state the buzzer sounds.

The following figure shows RESOLUTION key operations and the resulting display.

TQ8325
DIGITAL OPTICAL WAVELENGTH METER
INSTRUCTION MANUAL

2.7 Useful Functions for Measurement

MASTER RESET

0.000 No entry
nm



0.00
nm



0.0
nm



0.
nm



dn End



0.0
nm



0.00
nm



0.000
nm



UIP End

TQ8325
DIGITAL OPTICAL WAVELENGTH METER
INSTRUCTION MANUAL

2.8 D/A Output

2.8 D/A OUTPUT

Analog data converted from the displayed digital data is output from the BNC connector on the rear panel. The three lower display digits are converted to analog voltage for output.

2.8.1 Performance

Number of converted digits: Three lower display digits
 Output voltage: 0 V to 0.999 V (approx. 1 mV/count)
 D/A offset: Full Scale/2 (+0.5 V)
 Response: Approx. 150 ms
 Output impedance: Approx. 670
 Conversion accuracy: ± 3 mV (at temperature of 23°C ± 5 °C and humidity of 85% or less)

2.8.2 Relationship between Display and Output Voltage

Assume that the following is displayed by pressing the RESOLUTION key:

632.9
 μm nm

At this time, the D/A output is 0.329 V for the normal output mode. Assume that the following is displayed by the auto resolution function:

632.9. ■ ■
 μm nm

At this time, the digit marked "■" is assumed to be 0, and the D/A output is 0.900 V for the normal output mode.

2.8.3 Key Operations Relating to D/A OUT

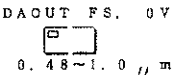

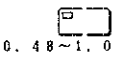
When the  and  keys are pressed, "DA-0" is displayed, and the D/A output becomes 0 V.

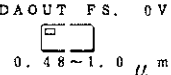
When the  key is pressed while "DA-0" is displayed, "DA-FS" is displayed and the D/A output is Full Scale (1 V). To release D/A OUT FS. 0 V, simultaneously press the

 and  keys.

TQ8325
DIGITAL OPTICAL WAVELENGTH METER
INSTRUCTION MANUAL

2.8 D/A Output

When the  and  keys are pressed at the same time, the D/A output voltage offset is set to Full Scale/2 (0.5 V) and the OFS lamp comes on.

When these keys are pressed again, D/A offset Full Scale/2 is released.

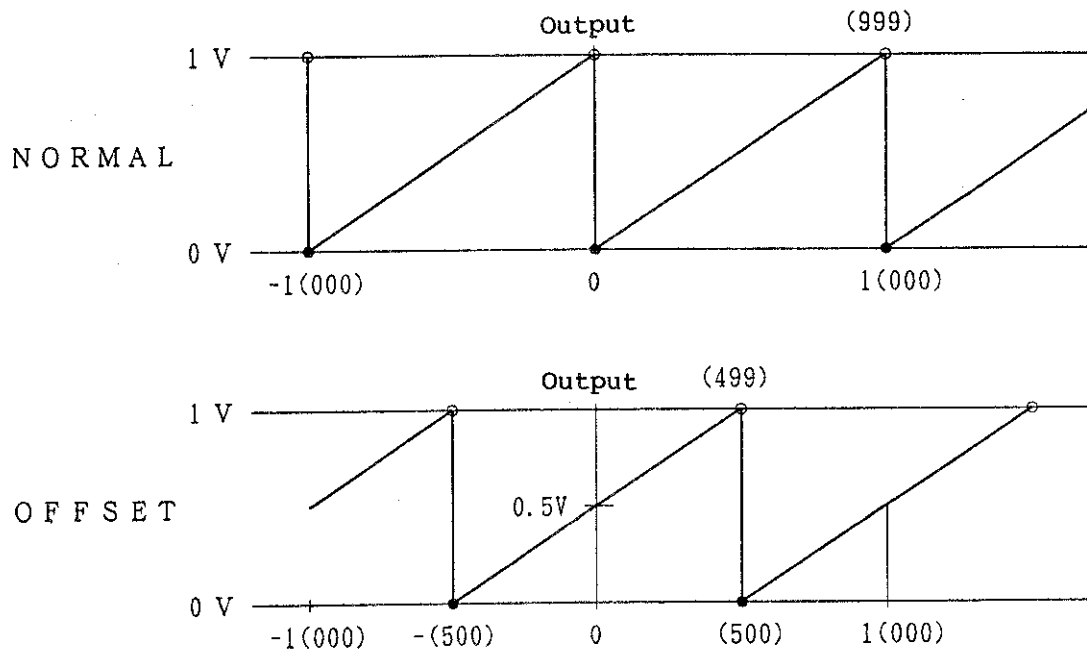



TQ8325
DIGITAL OPTICAL WAVELENGTH METER
INSTRUCTION MANUAL

2.9 Auxiliary Key Functions

2.9 AUXILIARY KEY FUNCTIONS

This section explains key functions, which, when known, make measuring easier the auxiliary.



2.9.1 Buzzer On/Off





Press the  and  keys to turn the buzzer on or off.

When the buzzer is on, pressing these two keys sets the buzzer to off and causes "BU OFF" to be displayed. When the buzzer is off, pressing these two keys sets the buzzer to on and causes "BU ON" to be displayed.

When master reset is executed, the buzzer is set to on.

2.9.2 Level Meter Illumination On/Off Setting

Press the  and  keys to set level meter illumination to on.

To set illumination to off, press the  and  keys again, or press the  and  keys (master reset function).

TQ8325
DIGITAL OPTICAL WAVELENGTH METER
INSTRUCTION MANUAL

2.10 Messages

2.10 MESSAGES

2.10.1 Displayed Messages

(1) $\left[\begin{array}{c} \mu m \\ \text{---} \\ nm \end{array} \right]$

Indicates that internal settings are being performed.

(2) $\left[\begin{array}{c} \mu m \\ \text{UP} \\ nm \end{array} \right] \text{ End}$

When the resolution setting is changed, indicates that the maximum resolution has already been set and that the upper limit of the resolution range has been reached.

(3) $\left[\begin{array}{c} \mu m \\ \text{dn} \\ nm \end{array} \right] \text{ End}$

When the resolution setting is changed, indicates that the minimum resolution has already been set and that the lower limit of the resolution range has been reached.

(4) $\left[\begin{array}{c} \mu m \\ \text{BU} \\ nm \end{array} \right] \text{ on}$

Indicates that the buzzer is enabled.

(5) $\left[\begin{array}{c} \mu m \\ \text{BU} \\ nm \end{array} \right] \text{ off}$

Indicates that the buzzer is disabled.

(6) $\left[\begin{array}{c} \mu m \\ \text{GPIB} \\ nm \end{array} \right]$

This display appears after power is turned on or master reset is executed. It means that a GPIB address will be displayed next.

When $\left[\begin{array}{c} \mu m \\ \text{GPIB} \\ nm \end{array} \right]$ displayed by pressing the SHIF and LOCAL

keys, the address setting mode is set.

(7) $\left[\begin{array}{c} \mu m \\ \text{8.8.8.8.8.8.8.8} \\ nm \end{array} \right]$

Indicates that a check to determine whether display elements are normal is being performed.

(8) $\left[\begin{array}{c} \mu m \\ \text{---} \\ nm \end{array} \right]$

Indicates that a changeover from the short wavelength measurement range to long wavelength measurement range or vice versa is being performed.

TQ8325
DIGITAL OPTICAL WAVELENGTH METER
INSTRUCTION MANUAL

2.10 Messages

(9) "DA-F5"

Indicates that D/A output is Full Scale (1 V).

(10) "DA-0"

Indicates that D/A output is 0 V.

(11) "A"
 μ m nm

This is displayed when the RESET key is pressed in both the average mode and hold state. The display is maintained until the data for 10 measurements is obtained.

2.10.2 Error Messages

"Err 1" GPIB syntax error
μ m nm

If the TQ8325 malfunctions, the messages below are displayed. Contact the nearest ADVANTEST dealer.

The addresses and telephone numbers of dealers are listed at the back of this manual.

"Err 0" Hardware error
μ m nm

"Err PL" PLL error
μ m nm

"Err rE" REFERENCE error
μ m nm

"Err oS" Optical switch error
μ m nm

TQ8325
DIGITAL OPTICAL WAVELENGTH METER
INSTRUCTION MANUAL

3.1 Outline

3. GPIB CONNECTION AND PROGRAMMING

3.1 OUTLINE

The TQ8325 digital optical wavelength meter can be connected to instrumentation bus GPIB (General-purpose interface bus) which, conforms to IEEE standard 488-1978, via the standard device GPIB interface. This chapter explains the specifications and functions of the GPIB interface.

This chapter explains the specifications and functions of the GPIB interface.

TQ8325
DIGITAL OPTICAL WAVELENGTH METER
INSTRUCTION MANUAL

3.2 Outline of GPIB

3.2 OUTLINE OF GPIB

GPIB is an interface system to which measuring devices, controllers, and peripherals can be connected via a simple cable (bus line). GPIB is superior to conventional interface systems in that it is easier to expand and use, and is electrically and mechanically compatible with other manufacturers' devices. A single bus cable enables construction of simple systems or sophisticated automatic instrumentation systems.

In the GPIB system, the addresses of individual devices connected to bus lines must be preset. Each device can serve as controller, talker, listener, or combinations of these.

During system operation, only one talker can send data to the bus line, but two or more listeners can receive that data.

The controller specifies the addresses of the talkers and listeners. It enables a talker to send data to listeners, or the controller itself, which is the talker in this case, can set measurement conditions in listeners.

To transfer eight bit-parallel/byte-serial data between devices, eight data lines are used. Data is transferred asynchronously in both directions. Since an asynchronous system is used, high-speed devices and low-speed devices can be mixed and connected arbitrarily.

Data (messages) exchanged between devices can include measured data, measurement conditions (programs), and various commands. ACCII codes are used for data exchange.

In addition to the eight data lines, GPIB supports three handshake lines, which control asynchronous data transfer between devices, and five control lines, which control data flow on the bus.

- The following signals are used for the handshake lines:

Data valid (DAV): Indicates that data is valid.

Not ready for data (NRFD): Indicates that data cannot be received.

Not data accepted (NDAC): Indicates that data reception has not been completed.

- The following signals are used for control lines:

Attention (ATN): Determines whether signal data on the data lines is an address, command, or something else.

Interface Clear (IFC): Clears the interface.

End or identify (BOI): Used for data transfer termination.

Service request (SRQ): Enables any device to call controller service.

Remote enable (REN): Used to remotely control a device that can be remotely programmed.

TQ8325
DIGITAL OPTICAL WAVELENGTH METER
INSTRUCTION MANUAL

3.2 Outline of GPIB

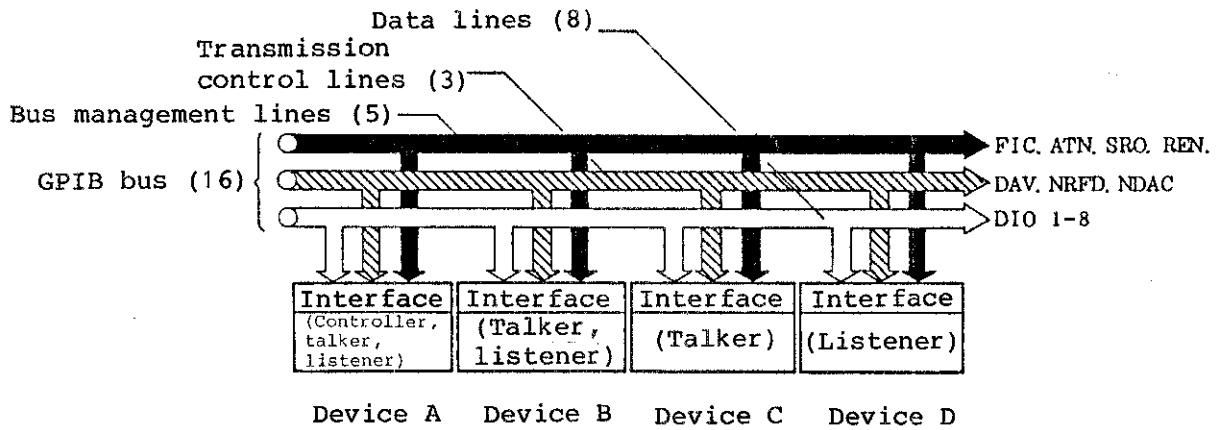

Figure 3-1 Outline of GPIB

TQ8325
DIGITAL OPTICAL WAVELENGTH METER
INSTRUCTION MANUAL

3.3 Specifications

3.3 SPECIFICATIONS

3.3.1 Use of GPIB

Standard specifications: IEEE standard 488-1978

Code: ASCII codes (binary codes for packed format)

Logical level: Logical 0 (high), +2.4 V or above
 Logical 1 (low), +0.4 V or below

Driver: General purpose interface bus transceiver
 Output voltage for low: +0.4 V or below, 48 mA
 Output voltage for high: +2.4 V or above, -5.2 mA

Receiver specifications: For +0.6 V or below, low state
 For +2.0 V or above, high state

Length of bus cable: Total length of bus cables must be less than
 [(number of devices connected to buses) x 2 m]
 and must not exceed 20 m.

Addressing: Any 31 talker and listener addresses can be set from the
 panel.

Connector: 24-pin GPIB connector
 57-20240-D35A (equivalent to ANFENORL connector)

TQ8325
DIGITAL OPTICAL WAVELENGTH METER
INSTRUCTION MANUAL

3.3 Specifications

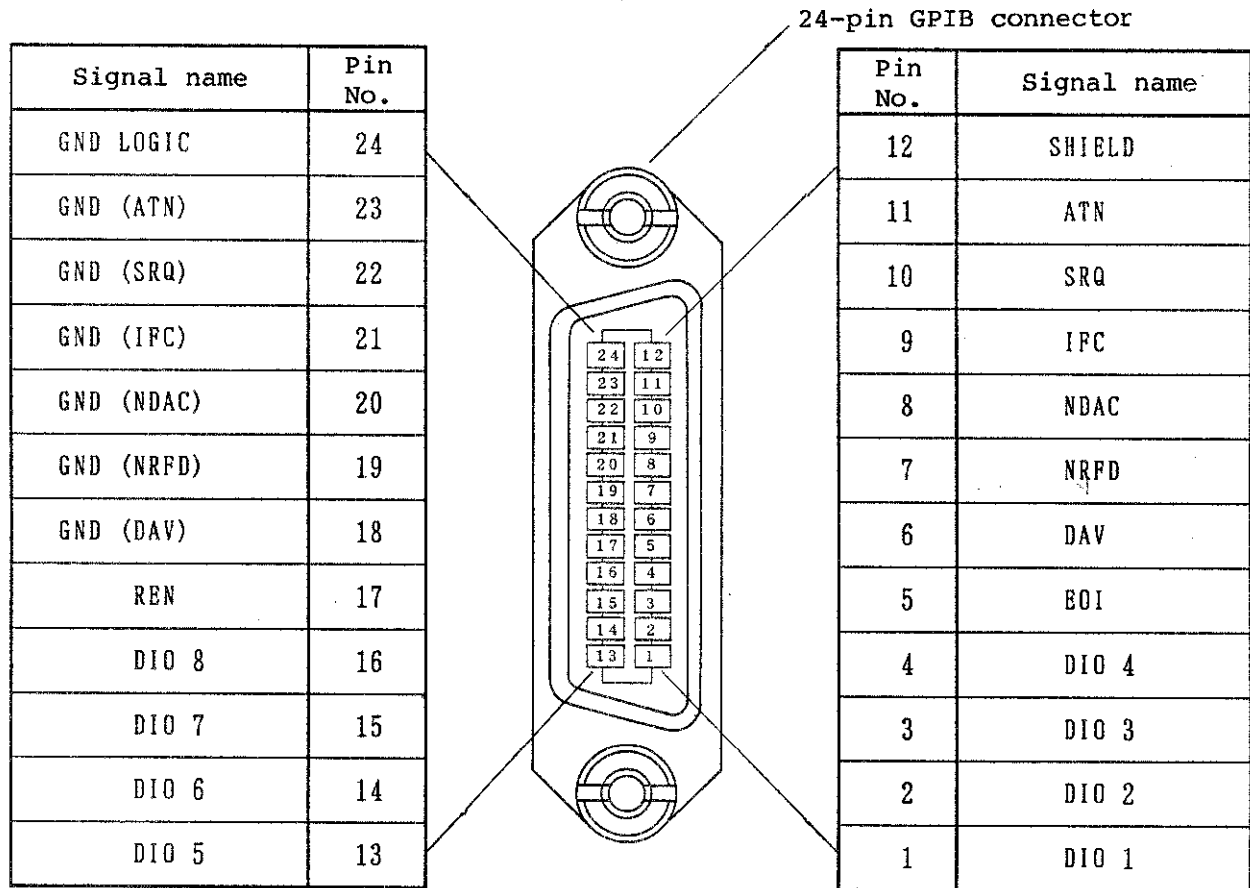

Figure 3-2 GPIB connector pin layout

Table 3-1 Interface functions

Code	Function and explanation
SH1	Source handshaking function
AH1	Acceptor handshaking function
T5	Basic talker function, serial pole function, talk-only mode function Talker release by listener specification
L4	Basic listener function Listener release by talker specification
SR1	Service request function

TQ8325
DIGITAL OPTICAL WAVELENGTH METER
INSTRUCTION MANUAL

3.3 Specifications

Table 3-1 - continued

Code	Function and explanation
RL1	Remote/local switching function
PP0	No parallel pole function is provided.
DC1	Device clear function
DT1	Device trigger function
C0	No control function is provided.
E2	Three-state driver is used.

TQ8325
DIGITAL OPTICAL WAVELENGTH METER
INSTRUCTION MANUAL

3.4 GPIB Handling Method

3.4 GPIB HANDLING METHOD

3.4.1 Connection to Devices

The GPIB system is configured from more than one device. Note the following to establish a complete system:

- (1) Before connecting GPIB to the TQ8325, the controller, and peripherals, check the preparation and operating state of the devices as indicated in the operation manuals.
- (2) The length of cables connected to measuring instruments and of the bus cable connected to the controller should be no longer than necessary. The total length of all bus cables must be less than [(number of devices connected to buses) x 2 m] and must not exceed 20 m. ADVANTEST provides the following standard bus cables:

Table 3-2 Standard bus cables (optional)

Length	Name
0.5 m	408JE-1P5 (DCB-SS1076X01-1)
1 m	408JE-101 (DCB-SS1076X02-1)
2 m	408JE-102 (DCB-SS1076X03-1)
4 m	408JE-104 (DCB-SS1076X04-1)

- (3) Bus cable connectors are the piggyback type: one connector has both a male and a female connector so that connectors can be placed one over another.
When connecting a bus cable, do not place more than two connectors over each another.
Fasten connectors securely with connector setscrews.
- (4) Before turning on the power to devices, confirm the power requirements, grounding, and settings of the devices.
Turn on the power to all devices connected to the buses.
If there is a device to which power has not been turned on, system operation cannot be guaranteed.

TQ8325
DIGITAL OPTICAL WAVELENGTH METER
INSTRUCTION MANUAL

3.5 GPIB Address Setting

3.5 GPIB ADDRESS SETTING

This section explains how to use the LOCAL key and how to set addresses when GPIB is used. For details on GPIB, see Chapter 3.

3.5.1 LOCAL Key

Use the ^{ADDRESS}
LOCAL key when the TQ8325 is controlled externally by the GPIB controller.

When the TQ8325 is controlled remotely through GPIB, the REMOTE lamp next to the LOCAL key comes on, and the front panel keys disabled.

When the ^{ADDRESS}
LOCAL key is pressed again, the REMOTE lamp goes off and the front panel keys are enabled. If the LOCAL LOCKOUT command is issued from the controller, the TQ8325 will not accept keyboard input regardless of whether the LOCAL key is pressed.

3.5.2 Address Setting Mode

In the GPIB system, talker and listener addresses are set from the panel, not with the ADDRESS key.

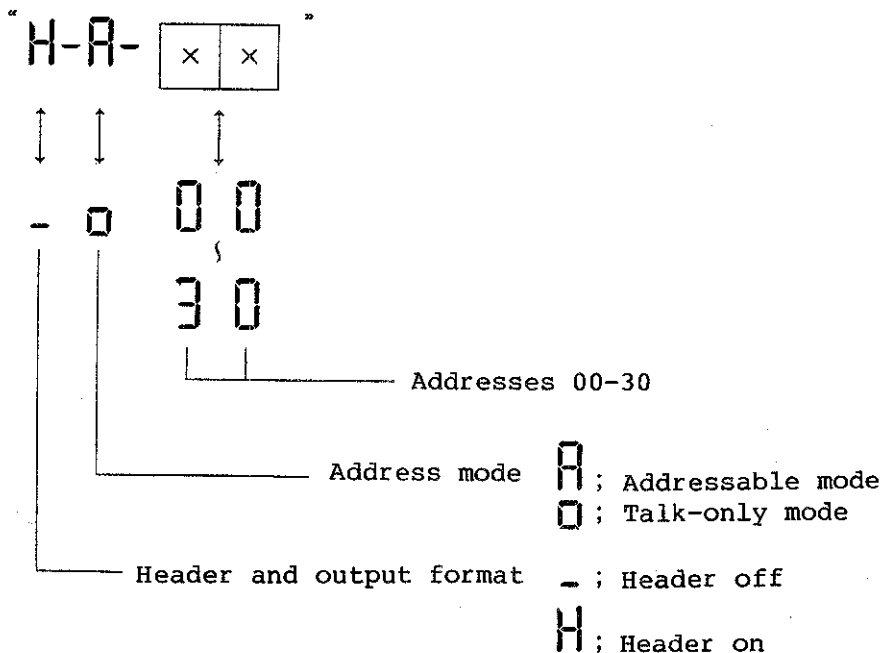

When the ^{SHIFT} and ^{ADDRESS}
LOCAL keys are pressed, "GPIB" is displayed and the address setting mode is set. The following is displayed:





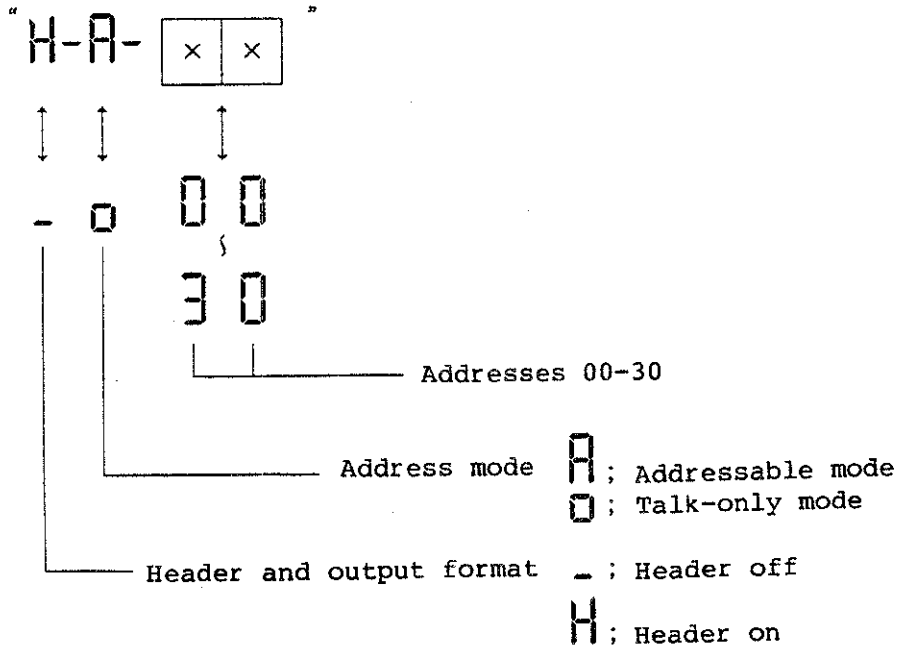



TQ8325
DIGITAL OPTICAL WAVELENGTH METER
INSTRUCTION MANUAL

3.5 GPIB Address Setting





First, since the header and output format display are blinking, press the  key to set the header on or off. After the header and output format have been set, press the  key to shift the blinking digits.

When the address mode display blinks, press the  key to set addressable mode or talk-only mode. After the address mode has been set, press the  key to shift the blinking digit to address display. When the address display blinks, press the  key to set the address. If the  key is pressed when address **30** is set, address **00** is displayed again.

When address setting has been completed, press the  and  keys to store the set address in memory and to release the address setting mode.

TQ8325
DIGITAL OPTICAL WAVELENGTH METER
INSTRUCTION MANUAL

3.5 GPIB Address Setting

Note that operations other than those with the  and  keys cannot change the set address even though master reset is executed.

TQ8325
DIGITAL OPTICAL WAVELENGTH METER
INSTRUCTION MANUAL

3.6 Talker Format

3.6 TALKER FORMAT

3.6.1 Talker Format

(1) Talker format

HEADER	Mantissa part	Exponent part	Delimiter
(a)	(b)	(c)	(d)

- (a) Header (two-digit alphabetical character)
- (b) Mantissa part (space + floating point : seven-digit number)
- (c) Exponent part (E + polarity (-) + one-digit number)
- (d) Delimiter (can be changed by program code)

(2) List of talker format

Measurement mode	Function	Range	
		Short wavelength	Long wavelength
Wavelength measurement (unit: m)	CHECK LASER LED CHOP DRIFT (LASER) DRIFT (LED)	WC 1000.000E-9 WA ddd.dddE-9 WL ddd.dE-9 WB ddd.ddE-9 WD±ddd.dddE-9 WG±ddd.dE-9	----- WA d.dddddE-6 WL d.ddddE-6 WB d.dddddE-6 WD±d.dddddE-9 WG±d.ddddE-9
Frequency measurement (unit: Hz)	CHECK LASER LED CHOP DRIFT (LASER) DRIFT (LED)	----- FA dddd.ddddE+12 FL dddd.dE+12 FB dddd.ddddE+12 FD±ddd.dE+12 FG±ddd.dE+12	----- FA dddd.ddddE+12 FL dddd.dE+12 FB dddd.ddddE+12 FD±ddd.dE+12 FG±ddd.dE+12

TQ8325
DIGITAL OPTICAL WAVELENGTH METER
INSTRUCTION MANUAL

3.6 Talker Format

3.6.2 Header

The header identifies the kind of measured data. It is output by ASCII code. When the header is turned off by output format, it is abbreviated.

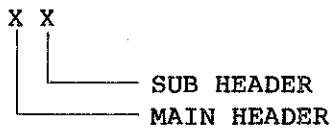

MAIN HEADER	Description
W	Wavelength measurement
F	Frequency measurement

SUB HEADER	Description
C	Check
A	LASER measurement
L	LED measurement
B	CHOP measurement
D	Deviation LASER measurement
G	Deviation LED measurement
E	ERROR DATA

TQ8325
DIGITAL OPTICAL WAVELENGTH METER
INSTRUCTION MANUAL

3.7 Program Codes

3.7 PROGRAM CODES

Item	Code	Description	Initial value
TRIGGER & RESET	E C Z	Measurement start (SINGLE measurement) Use during hold. RESET (Data Clear) MASTER RESET (Data & Panel Setting Data Clear)	
SERVICE REQUEST	S0 S1	Service request (SRQ) is sent and received. Service request (SRQ) is not sent.	0
MEASUREMENT MODE	K0 K1	Wavelength measurement Frequency measurement	0
FUNCTION SELECT	F0 F1 F2 F3	Check (only for wavelength measurement) Laser beam measurement LED light measurement CHOP light measurement	0
RANGE SELECT	W0 W1	Short wavelength: 0.48 μm to 1.0 μm Long wavelength: 1.0 μm to 1.6 μm	0
RESOLUTION	R0 R1 R2 R3 R4	7 1/2 digit display 6 1/2 digit display 5 1/2 digit display 4 1/2 digit display 3 1/2 digit display	0
SAMPLE MODE	M0 M1	RUN HOLD	0
AVERAGING	A0 A1	AVERAGING OFF AVERAGING ON	0
DRIFT MODE (Deviation)	RF0 RF1 RF2	Drift Off Drift On (First measured value) Drift On (First measured value)	0
REF. DATA set	RDnnnnnnnn		0
BUZZER	B0 B1	BUZZER OFF BUZZER ON	0

TQ8325
DIGITAL OPTICAL WAVELENGTH METER
INSTRUCTION MANUAL

3.7 Program Codes

Item	Code	Description	Initial value
DISPLAY CONTROL	L0	DISPLAY ON Level meter light OFF	0
	L1	DISPLAY ON Level meter light ON	
	L2	DISPLAY OFF Level meter light OFF	
OUTPUT FORMAT	H0	HEADER OFF	0
	H1	HEADER ON	
DELIMITER	D0	CR, LF+EOI	0
	D1	LF	
	D2	EOI	

Notes:

*1: PF1 measures the first value after accepting the command (Ref. Data) and displays the deviation from reference data.

PF2 measures the value set by RD command (Ref. Data) and displays the deviation from reference data.

*2: The range of reference value set by RD command is up to eight-digit integer.

Wavelength measurement: 0 to 2000000

Frequency measurement: 0 to 10000000

TQ8325
DIGITAL OPTICAL WAVELENGTH METER
INSTRUCTION MANUAL

3.8 Service Request

3.8 SERVICE REQUEST

The main unit, if in "SQ1" mode, requests the controller service. After requesting a service, it sends status bytes to the controller executing serial polling.

Status byte format

b7	b6	b5	b4	b3	b2	b1	b0
0	X	0	0	0	0	X	X

b0: sweep end
Set to "1" at the end of sweeping.
Indicates that there is sweep data to be output. Reset to "0" at the end of sweep data output.

b1: syntax error
Set to "1" when the program code contains a grammatical or setting error. Resets to "0" when the next program code is set.

b6: RQS
Indicates that the service is being requested. Set to "1" when one of the b0, b1 bit is set. Reset to "0" when all b0, b1 bits are reset.

Sweep end : Status byte = 65 (decade)
Syntax error: Status byte = 67 (decade)

TQ8325
DIGITAL OPTICAL WAVELENGTH METER
INSTRUCTION MANUAL

3.9 GPIB Programming Examples

3.9 GPIB PROGRAMMING EXAMPLES

(1) Programming example for HP9816

```
10 : DIM A$ (20)
20 : OUTPUT 701;"S1F1WOR1M1"
30 : OUTPUT 701;"E"
40 : ENTER 701;"A$"
50 : PRINT A$
60 : WAIT 2
70 : GOTO 30
80 : END
```

10 : Defines the area of data
20 : Sets in no service request are transferred (S1), laser optical measurement (F1), short wavelength (W0), five and half-digit specification (R1) and HOLD (M1)
30 : Starts a measurement
40 : Fetches data
50 : Indicates data
60 : Waits for two seconds
70 : Return to line 30

(2) Programming example for PC9801

```
10 ISET IFC
20 ISET REN
30 CMD DELIM=0
40 PRINT @1;"S1F1WOR1M1"
50 PRINT @1;"E"
60 INPUT @1;A$
70 PRINT A$
80 FOR I=1 TO 100 :NEXT I
90 GOTO 50
100 END
```

10 : Interface clear
20 : Sets a remote enable line the True
30 : Sets a delimiter CR+LF
40 : Sets in no service request are transferred (S1), laser optical measurement (F1), short wavelength (W0), five and half-digit specification (R1) and HOLD (M1)
50 : Starts a measurement
60 : Fetches data
70 : Indicates data
80 : Repeats from 1 to 100 (time waiting)
90 : Return to line 50

TQ8325
DIGITAL OPTICAL WAVELENGTH METER
INSTRUCTION MANUAL

3.9 GPIB Programming Examples

(3) Programming example for HP9816 (The measuring example with SRQ)

```
10 : DIM A$ (20)
20 : ON INTR 7 GOSUB SRQ
30 : CLEAR 701
40 : OUTPUT 701;"SOF2WORIM1"
50 : ENABLE INTR 7;2
60 : OUTPUT 701;"E"
70 : ! LOOP
80 : GOTO 70
90 : Srq: S=SPOLL(701)
100 : IF S< >65 THEN 150
110 : ENTER 701;A$
120 : PRINT A$
130 : WAIT 2
140 : OUTPUT 701;"E"
150 : ENABLE INTR 7;2
160 : RETURN
170 : END
```

10 : Defines the area of data
20 : Skips in SRQ if an interrupt occurs (Defines the interrupt processing routine)
40 : Sets in service request transferring (S0), LED optical measurement (F2), short wavelength (W0), five and half-digit specification (R1) and HOLD (M1)

50 : Interrupt enable
60 : Starts a measurement
70, 80 : Loop
90 : Pools to read the status
100: Skips in line 150 unless the status is 65 (when an interrupt occurs from non-701)
120: Indicates data
130: Waits for two seconds
140: Starts a measurement
150: Interrupt enable
160: Return

TQ8325
DIGITAL OPTICAL WAVELENGTH METER
INSTRUCTION MANUAL

3.9 GPIB Programming Examples

(4) Programming example for HP9801 (The measuring example with SRQ)

```
10  ISET IFC
20  ISET REN
30  CMD DELIM=0
40  ON SRQ GOSUB 100
50  SRQ ON
60  PRINT @1;"SOP2WOR1M1"
70  PRINT @1;"E"
80  *LOOP
90  GOTO 80
100 POLL 1, B
110 IF IEEE(5) < > 1 THEN 160
120 INPUT @1;A$
130 PRINT A$
140 FOR I=1 TO 2000 :NEXT I
150 PRINT @1;"E"
160 SRQ ON
170 RETURN
180 END
```

10 : Interface clear
20 : Sets remote enable line the True
30 : Sets delimiter CR+LF
40 : Skips in 100 if an interrupt occurs (Defines interrupt processing routine)
50 : Interrupt enable
60 : Sets in service request transferring (S0), LED optical measurement (F2), short wavelength (W0), five and half-digit specification (R1) and HOLD (M1)
70 : Starts a measurement
80, 90 : Loop
100: Pools to read the status
110: Check the interrupt (Skips in 160 when an interrupt occurs from non-address 1)
120: Fetches data
130: Indicates data
140: Repeats from 1 to 2000 (Time waiting)
150: Starts a measurement
160: Interrupt enable (Once SRQ is received, afterward SRQ receiving is prohibited)
170: Return

TQ8325
DIGITAL OPTICAL WAVELENGTH METER
INSTRUCTION MANUAL

4. Theory of Operation

4. THEORY OF OPERATION

TQ8325 creates interference fringes through a Michelson interferometer and counts them to measure wavelengths of a laser and LED. Figure 4 - 1 shows the Optical subsystem function.

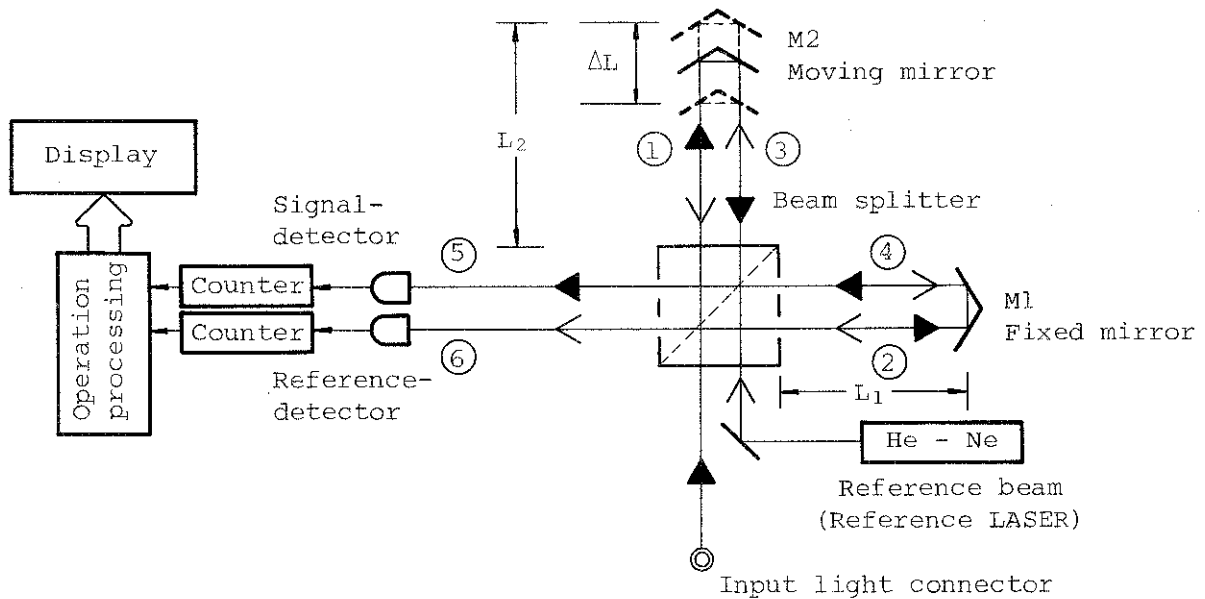

Figure 4 - 1 Optical subsystem function

An input light is split by a beam splitter and put into path ① and path ②. The light in path ① is reflected by the moving mirror and put into path ⑤. The light in path ② is reflected by the fixed mirror and put into path ⑤. These two light components are combined into an interference fringe, which is detected by the signal detector. A reference beam of a He-Ne laser is split by the beam splitter and put into paths ③ and ④. The split light components travel in the same optical path as that for the input light, but in the opposite direction. The light in path ③ is reflected by the moving mirror and put into path ⑥. The light in path ④ is reflected by the fixed mirror and put into path ⑥. These two light components are combined into an interference fringe, which is detected by the reference detector. Each time the moving mirror travels $\lambda/2$, an interference fringe is generated and the detector generates a pulse.

Assume that

Wavelength of reference beam in vacuum = λ_{ref}

Refractive index in air for this wavelength = n_{ref}

Wavelength of input light in vacuum = λ_{sig}

Refractive index in air for this wavelength = n_{sig}

Number of pulses generated by reference detector while moving mirror travels $\Delta L = N_{ref}$

TQ8325
DIGITAL OPTICAL WAVELENGTH METER
INSTRUCTION MANUAL

4. Theory of Operation

Number of pulses generated by signal detector while moving mirror travels
 $\Delta L = N_{sig}$

Then,

$$\Delta L = \frac{\lambda_{ref}}{2n_{ref}} N_{ref} = \frac{\lambda_{sig}}{2n_{sig}} N_{sig}$$

From this,

$$\lambda_{sig} = \lambda_{ref} \frac{N_{ref} n_{sig}}{N_{sig} n_{ref}}$$

The TQ8325 uses 0.6329914 μm (wavelength of He-Ne laser in vacuum) as λ_{ref} . If uses wavelength characteristics of the air refractive index as a compensation value n_{sig}/n_{ref} and obtains λ_{sig} (wavelength of input light in vacuum) by calculating N_{ref}/N_{sig} .

The wavelength-dependency of the air refractive index n_s can be calculated by the following expression.

$$(n_s - 1) \cdot 10^8 = 6432.8 + \frac{2949810}{(146 - \lambda^{-2})} + \frac{25540}{(41 - \lambda^{-2})} \dots (*)$$

(*) : Chronological Table of Science (Japan: Maruzen Corp. , 1989), p.516.

The environmental conditions of the refractive index n_s is defined as in the standard air (15°C, 760 mmHg, the CO₂ concentration of 0.03% in the dry air).

To convert a measured wavelength in a vacuum into a wavelength in air, divide by the air refractive index for that wavelength.

Frequency is operated by the following expression to be displayed.

$$F = \frac{c}{\lambda}$$

(c: Optical speed in vacuum: 2.99792458 x 10⁸ m/s)

(F: Frequency)

TQ8325
DIGITAL OPTICAL WAVELENGTH METER
INSTRUCTION MANUAL

5. Specifications

5. SPECIFICATIONS

(1) Optical specification

Measurement wavelength range: 0.48 μm to 1.0 μm (short wavelength band)
1.0 μm to 1.65 μm (long wavelength band)
Measurement frequency range: 300THz to 625THz (short wavelength band)
181THz to 300THz (long wavelength band)
Measurement input level: -15 dBm to +3 dBm (0.48 μm to 0.6 μm)
-23 dBm to +3 dBm (0.6 μm to 1.65 μm)
-27 dBm to +3 dBm (1.2 μm to 1.6 μm)
Display: 7 digits (decimal), green LED
Display resolution: 1 nm, 0.1 nm, 0.01 nm, 0.001 nm
100GHz, 10GHz, 1GHz, 100MHz
Auto-resolution: The resolution measured by spectral width of
measured light varies automatically (Figure 5-1)
Measurement wavelength accuracy: \pm wavelength spectral width (nm) x
5/100 \pm 5ppm \pm 1 count...(*)
Measurement frequency accuracy: \pm Frequency spectral width (GHz) x
5/100 \pm 5ppm \pm 1 count...(*)

(*): The error of the wavelength (frequency) accuracy arises caused
by the following:
• An error caused by the wavelength loss characteristics of the
optical system..... \pm wavelength spectral width * 5/100
• An error caused that the optical system is not in the vacuum
..... \pm 5 ppm
• A quantization error of the counter..... \pm 1 count

Measurement stability: \pm 1 count for AVG mode ON
AVG mode: Displays the running average in 10 measurements.
Sampling rate: 0.2 sec
Optical input: FC/PC, GI50/125

(2) General specification

Analog output: Analog conversion output of lower three display digits
GPIB: Standard equipment
Operating conditions: 10°C to +40°C, relative humidity of 85% or less
Temperature range in which accuracy guaranteed: 25°C \pm 10°C
Power supply: 90 to 132 VAC, 50/60 Hz (198 to 250 V (usable range)
depending on specification)
Power consumption: 52 VA or less
Dimensions: Approx. 300 (W) x 132 (H) x 450 (D) mm
Mass: Approx. 12 kg

TQ8325
 DIGITAL OPTICAL WAVELENGTH METER
 INSTRUCTION MANUAL

5. Specifications

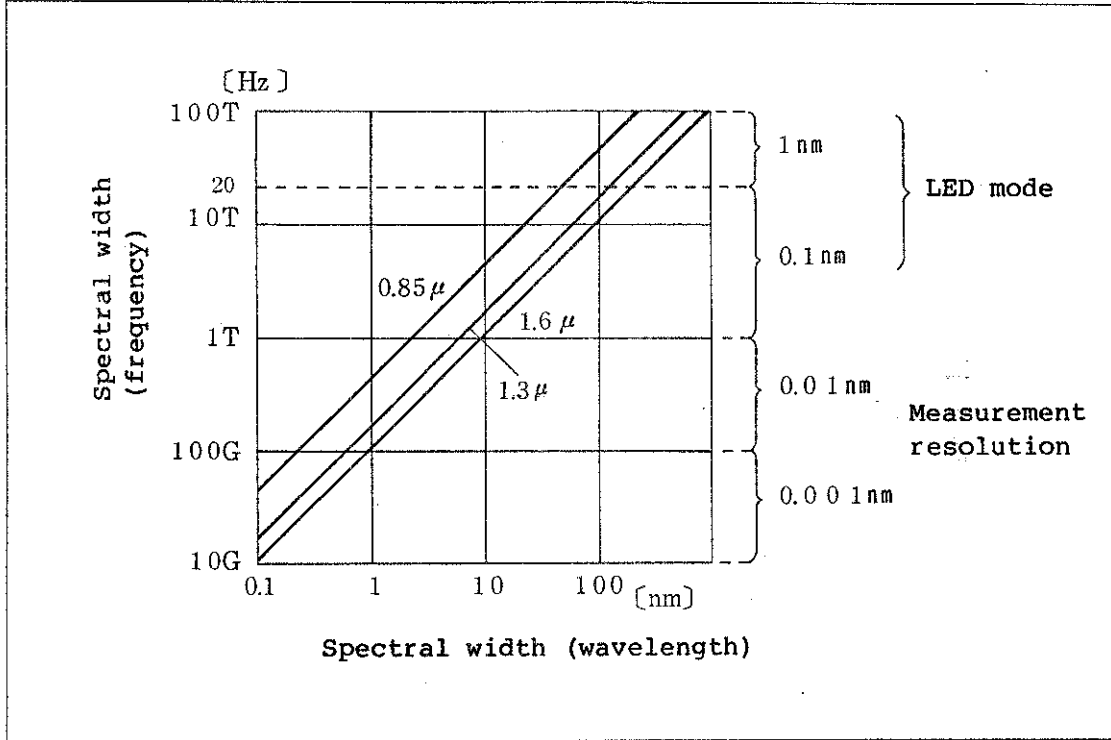

Figure 5 - 1 Relationship between spectral width and measurement resolution

TQ8325
DIGITAL OPTICAL WAVELENGTH METER
INSTRUCTION MANUAL

6. PERFORMANCE TEST

6. PERFORMANCE TEST

This chapter describes how to test the performance of optical wavelength meter TQ8325.

TQ8325 has high resolution and the optical wavelength measurement value is affected by the environment temperature. In order to obtain correct test results, evaluate under the following conditions;

Environment temperature : $25^{\circ}\text{C} \pm 2^{\circ}\text{C}$
Relative humidity : 85% or less
Warm-up period : 1 hour or more

Inside of light input connector, optical fiber (GI 50/125 μm) is connected. If the surface of fiber connecting terminal is dirty, it may happen that input loss increases or wavelength measurement loses its stability by the reflected light generated by imperfect connection. Before testing the performance, try to clean the surface of fiber connecting terminal.

TQ8325
DIGITAL OPTICAL WAVELENGTH METER
INSTRUCTION MANUAL

6.1 Necessary Equipments

6.1 NECESSARY EQUIPMENTS

Table 6-1 shows the equipments, specifications and models needed for TQ8325 performance test.

Table 6-1 Necessary equipments

Equipment name	Minimum-Use-Specifications		Recommendation
He-Ne LASER	$\lambda = 632.991\text{nm}$ Fiberized output Minimum power Level stability	10/125 μm -15dBm $\pm 0.2\text{dB}$	Anritsu, MG99B
He-Ne LASER	$\lambda = 1523.488\text{nm}$ Fiberized output Minimum power	10/125 μm -15dBm	PMS Electro-optics, LSIR-0051-152
Optical power meter and sensor	Power range Wavelength range Level accuracy	-60 to 0dBm 400 to 1100nm 800 to 1650nm $\pm 5\%$	Advantest, TQ8215 TQ82014 Q82018A
Optical attenuator	Maximum attenuation	60dB	Hewlett Packard, HP8158B
Digital multimeter	Resolution Accuracy	1mV $\pm 0.03\%$	Advantest, R6450

TQ8325
DIGITAL OPTICAL WAVELENGTH METER
INSTRUCTION MANUAL

6.2 Items of Performance Test

6.2 ITEMS OF PERFORMANCE TEST

Table 6-2 shows the items of TQ8325 performance test.
In the performances of TQ8325, the wavelength accuracy of LED mode and the upper limit of input sensitivity are excluded from the test items because the illuminant needed for the test is not for general use.

Table 6-2 Performance test specification

	Test items		Specifications		Remarks
(1)	Measurement wavelength	Accuracy	632.991nm	632.990 to 632.993nm	AVG ON 25°C ± 2°C
		Sensitivity		-23.5dBm or less	
		Accuracy	1523.488nm	1523.483 to 1523.492nm	
		Sensitivity		-23.5dBm or less	
(2)	Frequency measuring mode		632.991nm	473612.2 ± 1GHz	
(3)	Deviation measuring mode		632.991nm	0.000nm ± 0.002nm	
(4)	CHECK mode		1.000000 or 1.000001		
(5)	MASTER RESET		Initialization is performed. "C...","READY" are not displayed.		Initialization LASER, 0.48 to 1.0, AVG OFF, LIGHT ON HOLD OFF, BUZZER ON, DRIFT OFF
(6)	PANEL TEST		All keys are active. All LEDs are lighted.		Confirm the light of LED by MASTER RESET.
(7)	D/A OUT	DA-0		0V ± 3mV	25°C ± 2°C
		DA/FS		1V ± 3mV	
		632.991nm		991mV ± 3mV	
		632.991nm (D/A OFFSET)		491mV ± 3mV	
(8)	Operation check for no-input.		When input is not done, wrong display is not made in each mode.		
(9)	GPIB		Connect controller. Sending command and receiving data are possible.		

TQ8325
DIGITAL OPTICAL WAVELENGTH METER
INSTRUCTION MANUAL

6.3 Test Method

6.3 TEST METHOD

(1) Measurement wavelength accuracy / sensitivity

(a) 632.991 nm

Setup: LASER mode, wavelength range 0.48 to 1.0, AVG ON
Input: Confirm the optical intensity is under -23.5 dBm
through attenuator with the power meter.
Allowed value: 632.990 to 632.993 nm

(b) 1523.488 nm

Setup: LASER mode, wavelength range 1.0 to 1.6, AVG ON
Input: Confirm the optical intensity is under -23.5 dBm
through attenuator with the power meter.
Allowed value: 1523.483 to 1523.492 nm

(2) Frequency measurement mode

Setup: LASER FREQUENCY mode, wavelength range 0.48 to 1.0, AVG ON
ON
Input: Confirm the optical intensity is under -23.5 dBm
through attenuator with the power meter.
Allowed value: 473611.2 to 473613.2 GHz

(3) Deviation measuring mode

Setup: LASER DRIFT mode, wavelength range 0.48 to 1.0, AVG ON
Input: Confirm the optical intensity is under -23.5 dBm
through attenuator with the power meter.
Allowed value: -2 to +2 pm

(4) CHECK mode

Setup: CHECK mode
Input: Unnecessary
Allowed value: 1.000000 or 1.000001

(5) MASTER RESET

Press the MASTER RESET key.
"0000" is displayed after all LEDs are lighted and GPIB address is
displayed.
Confirm the display of "C _ _ _" does not appear.

(6) PANEL TEST

By pressing all the keys in buzzer ON condition, confirm the sound.
By testing MASTER RESET, confirm all the LEDs light.

TQ8325
DIGITAL OPTICAL WAVELENGTH METER
INSTRUCTION MANUAL

6.3 Test Method

(7) D/A OUT

Analog monitor voltage output from the rear panel is measured with the digital multimeter.

(a) D/A 0

Make the output condition DA-0 by and key.
Output voltage should be 0 V \pm 3 mV. SHIFT 0.48~1.0 μ m

(b) DA/FS

By pressing key in (a) state, set to DA Full Scale.
 0.48~1.0 μ m
Output voltage should be 1 V \pm 3 mV.

(c) When measuring 632.991 nm.

Measure wavelength on the conditions of test method (1)-(a).
Output voltage should be 991 \pm 3 mV.

(d) When measuring 632.991 nm. (DA Offset)

Make DA offset output by and key.
 SHIFT 1.0~1.6 μ m

Measure wavelength on the conditions of test method (1)-(a).
Output voltage should be 491 \pm 3 mV.

(8) Operation check for no-input.

Put a protecting cap on the input connector. Confirm that BUSY indicator does not light and wrong measurement is not performed.

(9) GPIB

Confirm that the function operates by transmitting GPIB command and also data can be received.

Example: Transmitting "K0F0" enables wavelength measurement and the mode becomes CHECK. Receiving the data here obtains "WC 1000.000E-9." (In Header-ON case)

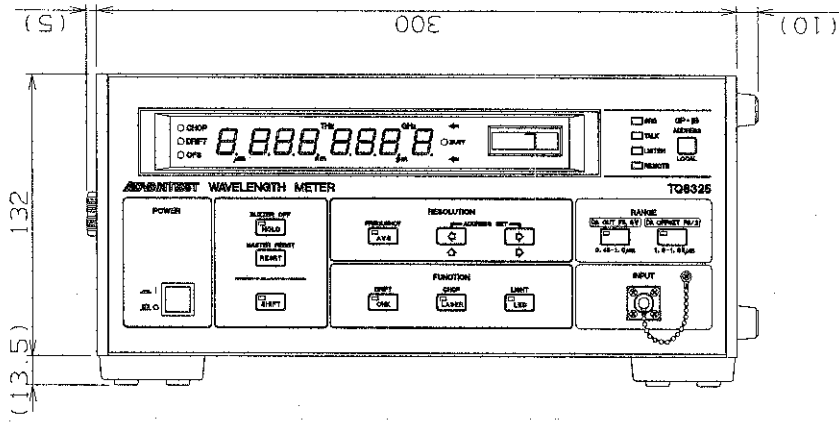
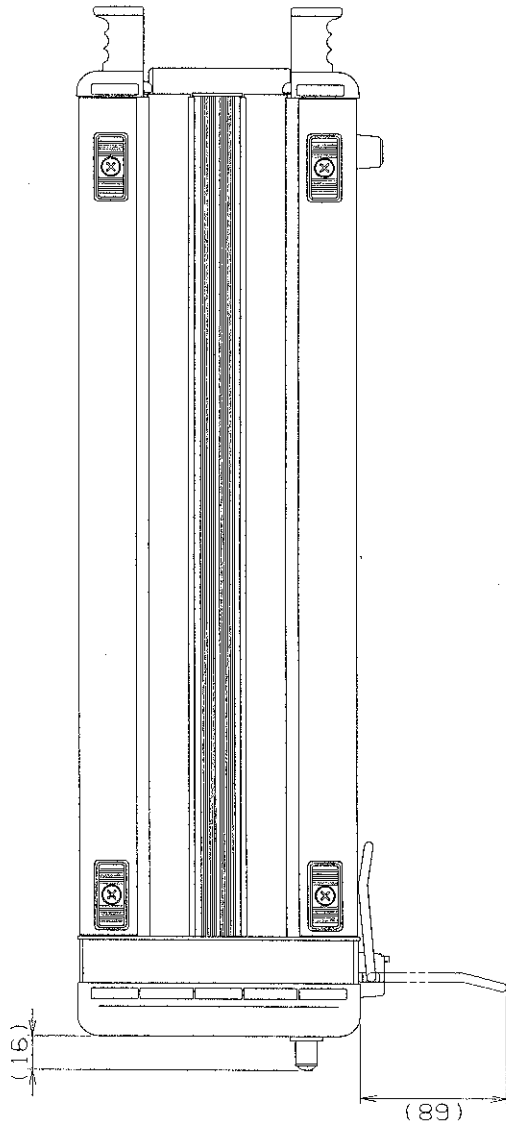
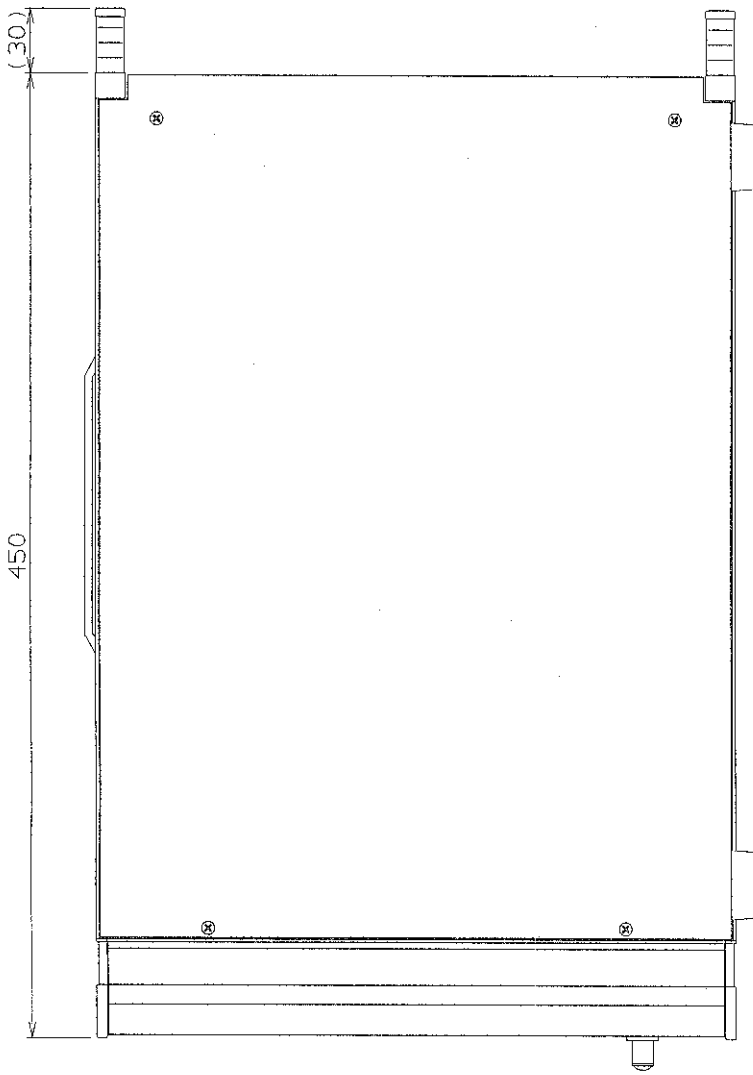

Unit : mm

CAUTION

This drawing shows external dimensions of this instrument.
The difference in products and options used can cause a change in the appearance of the instrument.

DIMENSIONAL OUTLINE DRAWING

IMPORTANT INFORMATION FOR ADVANTEST SOFTWARE

PLEASE READ CAREFULLY: This is an important notice for the software defined herein. Computer programs including any additions, modifications and updates thereof, operation manuals, and related materials provided by Advantest (hereafter referred to as "SOFTWARE"), included in or used with hardware produced by Advantest (hereafter referred to as "PRODUCTS").

SOFTWARE License

All rights in and to the SOFTWARE (including, but not limited to, copyright) shall be and remain vested in Advantest. Advantest hereby grants you a license to use the SOFTWARE only on or with Advantest PRODUCTS.

Restrictions

- (1) You may not use the SOFTWARE for any purpose other than for the use of the PRODUCTS.
- (2) You may not copy, modify, or change, all or any part of, the SOFTWARE without permission from Advantest.
- (3) You may not reverse engineer, de-compile, or disassemble, all or any part of, the SOFTWARE.

Liability

Advantest shall have no liability (1) for any PRODUCT failures, which may arise out of any misuse (misuse is deemed to be use of the SOFTWARE for purposes other than its intended use) of the SOFTWARE. (2) For any dispute between you and any third party for any reason whatsoever including, but not limited to, infringement of intellectual property rights.

LIMITED WARRANTY

1. Unless otherwise specifically agreed by Seller and Purchaser in writing, Advantest will warrant to the Purchaser that during the Warranty Period this Product (other than consumables included in the Product) will be free from defects in material and workmanship and shall conform to the specifications set forth in this Operation Manual.
2. The warranty period for the Product (the "Warranty Period") will be a period of one year commencing on the delivery date of the Product.
3. If the Product is found to be defective during the Warranty Period, Advantest will, at its option and in its sole and absolute discretion, either (a) repair the defective Product or part or component thereof or (b) replace the defective Product or part or component thereof, in either case at Advantest's sole cost and expense.
4. This limited warranty will not apply to defects or damage to the Product or any part or component thereof resulting from any of the following:
 - (a) any modifications, maintenance or repairs other than modifications, maintenance or repairs (i) performed by Advantest or (ii) specifically recommended or authorized by Advantest and performed in accordance with Advantest's instructions;
 - (b) any improper or inadequate handling, carriage or storage of the Product by the Purchaser or any third party (other than Advantest or its agents);
 - (c) use of the Product under operating conditions or environments different than those specified in the Operation Manual or recommended by Advantest, including, without limitation, (i) instances where the Product has been subjected to physical stress or electrical voltage exceeding the permissible range and (ii) instances where the corrosion of electrical circuits or other deterioration was accelerated by exposure to corrosive gases or dusty environments;
 - (d) use of the Product in connection with software, interfaces, products or parts other than software, interfaces, products or parts supplied or recommended by Advantest;
 - (e) incorporation in the Product of any parts or components (i) provided by Purchaser or (ii) provided by a third party at the request or direction of Purchaser or due to specifications or designs supplied by Purchaser (including, without limitation, any degradation in performance of such parts or components);
 - (f) Advantest's incorporation or use of any specifications or designs supplied by Purchaser;
 - (g) the occurrence of an event of force majeure, including, without limitation, fire, explosion, geological change, storm, flood, earthquake, tidal wave, lightning or act of war; or
 - (h) any negligent act or omission of the Purchaser or any third party other than Advantest.
5. **EXCEPT TO THE EXTENT EXPRESSLY PROVIDED HEREIN, ADVANTEST HEREBY EXPRESSLY DISCLAIMS, AND THE PURCHASER HEREBY WAIVES, ALL WARRANTIES, WHETHER EXPRESS OR IMPLIED, STATUTORY OR OTHERWISE, INCLUDING, WITHOUT LIMITATION, (A) ANY WARRANTY OF MERCHANTABILITY OR FITNESS FOR A PARTICULAR PURPOSE AND (B) ANY WARRANTY OR REPRESENTATION AS TO THE VALIDITY, SCOPE, EFFECTIVENESS OR USEFULNESS OF ANY TECHNOLOGY OR ANY INVENTION.**
6. **THE REMEDY SET FORTH HEREIN SHALL BE THE SOLE AND EXCLUSIVE REMEDY OF THE PURCHASER FOR BREACH OF WARRANTY WITH RESPECT TO THE PRODUCT.**
7. **ADVANTEST WILL NOT HAVE ANY LIABILITY TO THE PURCHASER FOR ANY INDIRECT, INCIDENTAL, SPECIAL, CONSEQUENTIAL OR PUNITIVE DAMAGES, INCLUDING, WITHOUT LIMITATION, LOSS OF ANTICIPATED PROFITS OR REVENUES, IN ANY AND ALL CIRCUMSTANCES, EVEN IF ADVANTEST HAS BEEN ADVISED OF THE POSSIBILITY OF SUCH DAMAGES AND WHETHER ARISING OUT OF BREACH OF CONTRACT, WARRANTY, TORT (INCLUDING, WITHOUT LIMITATION, NEGLIGENCE), STRICT LIABILITY, INDEMNITY, CONTRIBUTION OR OTHERWISE. TORT (INCLUDING, WITHOUT LIMITATION, NEGLIGENCE), STRICT LIABILITY, INDEMNITY, CONTRIBUTION OR OTHERWISE.**
8. **OTHER THAN THE REMEDY FOR THE BREACH OF WARRANTY SET FORTH HEREIN, ADVANTEST SHALL NOT BE LIABLE FOR, AND HEREBY DISCLAIMS TO THE FULLEST EXTENT PERMITTED BY LAW ANY LIABILITY FOR, DAMAGES FOR PRODUCT FAILURE OR DEFECT, WHETHER ARISING OUT OF BREACH OF CONTRACT, TORT (INCLUDING, WITHOUT LIMITATION, NEGLIGENCE), STRICT LIABILITY, INDEMNITY, CONTRIBUTION OR OTHERWISE.**

CUSTOMER SERVICE DESCRIPTION

In order to maintain safe and trouble-free operation of the Product and to prevent the incurrence of unnecessary costs and expenses, Advantest recommends a regular preventive maintenance program under its maintenance agreement.

Advantest's maintenance agreement provides the Purchaser on-site and off-site maintenance, parts, maintenance machinery, regular inspections, and telephone support and will last a maximum of ten years from the date the delivery of the Product. For specific details of the services provided under the maintenance agreement, please contact the nearest Advantest office listed at the end of this Operation Manual or Advantest's sales representatives.

Some of the components and parts of this Product have a limited operating life (such as, electrical and mechanical parts, fan motors, unit power supply, etc.). Accordingly, these components and parts will have to be replaced on a periodic basis. If the operating life of a component or part has expired and such component or part has not been replaced, there is a possibility that the Product will not perform properly. Additionally, if the operating life of a component or part has expired and continued use of such component or part damages the Product, the Product may not be repairable. Please contact the nearest Advantest office listed at the end of this Operation Manual or Advantest's sales representatives to determine the operating life of a specific component or part, as the operating life may vary depending on various factors such as operating condition and usage environment.

SALES & SUPPORT OFFICES

Advantest Korea Co., Ltd.

22BF, Kyobo KangNam Tower,
1303-22, Seocho-Dong, Seocho-Ku, Seoul #137-070, Korea
Phone: +82-2-532-7071
Fax: +82-2-532-7132

Advantest (Suzhou) Co., Ltd.

Shanghai Branch Office:
Bldg. 6D, NO.1188 Gumei Road, Shanghai, China 201102 P.R.C.
Phone: +86-21-6485-2725
Fax: +86-21-6485-2726

Shanghai Branch Office:
406/F, Ying Building, Quantum Plaza, No. 23 Zhi Chun Road,
Hai Dian District, Beijing,
China 100083
Phone: +86-10-8235-3377
Fax: +86-10-8235-6717

Advantest (Singapore) Pte. Ltd.

438A Alexandra Road, #08-03/06
Alexandra Technopark Singapore 119967
Phone: +65-6274-3100
Fax: +65-6274-4055

Advantest America, Inc.

3201 Scott Boulevard, Suite, Santa Clara, CA 95054, U.S.A
Phone: +1-408-988-7700
Fax: +1-408-987-0691

ROHDE & SCHWARZ Europe GmbH

Mühldorfstraße 15 D-81671 München, Germany
(P.O.B. 80 14 60 D-81614 München, Germany)
Phone: +49-89-4129-13711
Fax: +49-89-4129-13723

ADVANTEST[®]

<http://www.advantest.co.jp>