ADVANTEST®
ADVANTEST CORPORATION

TR5821/22/23/23H

Universal Counter

Operation Manual

MANUAL NUMBER FOE-8311233K03

Safety Summary

To ensure thorough understanding of all functions and to ensure efficient use of this instrument, please read the manual carefully before using. Note that Advantest bears absolutely no responsibility for the result of operations caused due to incorrect or inappropriate use of this instrument.

If the equipment is used in a manner not specified by Advantest, the protection provided by the equipment may be impaired.

- **Warning Labels**

Warning labels are applied to Advantest products in locations where specific dangers exist. Pay careful attention to these labels during handling. Do not remove or tear these labels. If you have any questions regarding warning labels, please ask your nearest Advantest dealer. Our address and phone number are listed at the end of this manual.

Symbols of those warning labels are shown below together with their meaning.

DANGER: Indicates an imminently hazardous situation which will result in death or serious personal injury.

WARNING: Indicates a potentially hazardous situation which will result in death or serious personal injury.

CAUTION: Indicates a potentially hazardous situation which will result in personal injury or a damage to property including the product.

- **Basic Precautions**

Please observe the following precautions to prevent fire, burn, electric shock, and personal injury.

- Use a power cable rated for the voltage in question. Be sure however to use a power cable conforming to safety standards of your nation when using a product overseas.
- When inserting the plug into the electrical outlet, first turn the power switch OFF and then insert the plug as far as it will go.
- When removing the plug from the electrical outlet, first turn the power switch OFF and then pull it out by gripping the plug. Do not pull on the power cable itself. Make sure your hands are dry at this time.
- Before turning on the power, be sure to check that the supply voltage matches the voltage requirements of the instrument.
- Connect the power cable to a power outlet that is connected to a protected ground terminal. Grounding will be defeated if you use an extension cord which does not include a protected ground terminal.
- Be sure to use fuses rated for the voltage in question.
- Do not use this instrument with the case open.
- Do not place anything on the product and do not apply excessive pressure to the product. Also, do not place flower pots or other containers containing liquid such as chemicals near this

product.

- When the product has ventilation outlets, do not stick or drop metal or easily flammable objects into the ventilation outlets.
- When using the product on a cart, fix it with belts to avoid its drop.
- When connecting the product to peripheral equipment, turn the power off.

- **Caution Symbols Used Within this Manual**

Symbols indicating items requiring caution which are used in this manual are shown below together with their meaning.

DANGER: Indicates an item where there is a danger of serious personal injury (death or serious injury).

WARNING: Indicates an item relating to personal safety or health.

CAUTION: Indicates an item relating to possible damage to the product or instrument or relating to a restriction on operation.

- **Safety Marks on the Product**

The following safety marks can be found on Advantest products.

 : ATTENTION - Refer to manual.

 : Protective ground (earth) terminal.

 : DANGER - High voltage.

 : CAUTION - Risk of electric shock.

- **Replacing Parts with Limited Life**

The following parts used in the instrument are main parts with limited life.

Replace the parts listed below before their expected lifespan has expired to maintain the performance and function of the instrument.

Note that the estimated lifespan for the parts listed below may be shortened by factors such as the environment where the instrument is stored or used, and how often the instrument is used. The parts inside are not user-replaceable. For a part replacement, please contact the Advantest sales office for servicing.

Each product may use parts with limited life.

For more information, refer to the section in this document where the parts with limited life are described.

Main Parts with Limited Life

Part name	Life
Unit power supply	5 years
Fan motor	5 years
Electrolytic capacitor	5 years
LCD display	6 years
LCD backlight	2.5 years
Floppy disk drive	5 years
Memory backup battery	5 years

- **Hard Disk Mounted Products**

The operational warnings are listed below.

- Do not move, shock and vibrate the product while the power is turned on. Reading or writing data in the hard disk unit is performed with the memory disk turning at a high speed. It is a very delicate process.
- Store and operate the products under the following environmental conditions.
 - An area with no sudden temperature changes.
 - An area away from shock or vibrations.
 - An area free from moisture, dirt, or dust.
 - An area away from magnets or an instrument which generates a magnetic field.
- Make back-ups of important data.
 - The data stored in the disk may become damaged if the product is mishandled. The hard disc has a limited life span which depends on the operational conditions. Note that there is no guarantee for any loss of data.

- **Precautions when Disposing of this Instrument**

When disposing of harmful substances, be sure dispose of them properly with abiding by the state-provided law.

Harmful substances: (1) PCB (polycarbon biphenyl)
 (2) Mercury
 (3) Ni-Cd (nickel cadmium)
 (4) Other
 Items possessing cyan, organic phosphorous and hexadic chromium and items which may leak cadmium or arsenic (excluding lead in solder).

Example: fluorescent tubes, batteries

Environmental Conditions

This instrument should be only be used in an area which satisfies the following conditions:

- An area free from corrosive gas
- An area away from direct sunlight
- A dust-free area
- An area free from vibrations
- Altitude of up to 2000 m

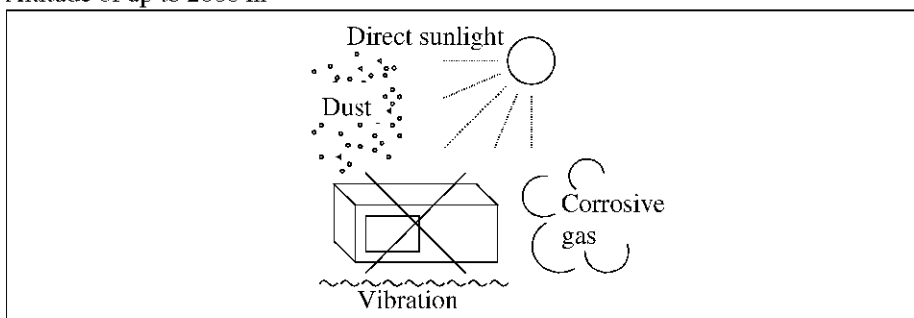

Figure-1 Environmental Conditions

- Operating position

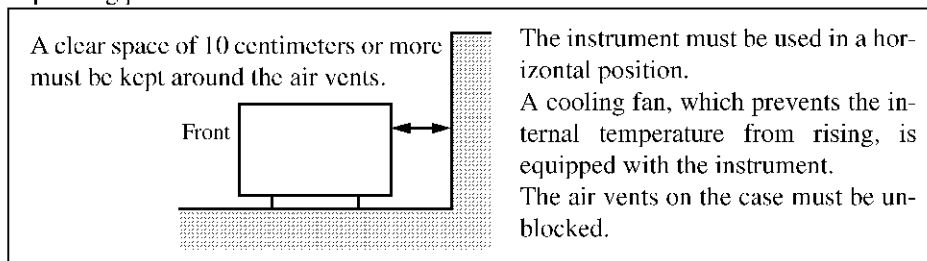

Figure-2 Operating Position

- Storage position

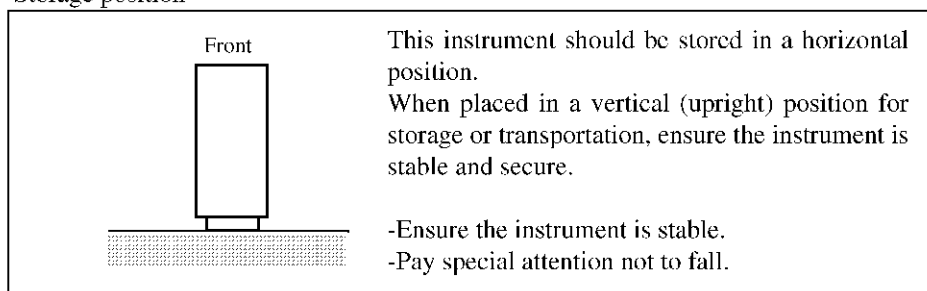

Figure-3 Storage Position

- The classification of the transient over-voltage, which exists typically in the main power supply, and the pollution degree is defined by IEC61010-1 and described below.

Impulse withstand voltage (over-voltage) category II defined by IEC60364-4-443

Pollution Degree 2

Types of Power Cable

Replace any references to the power cable type, according to the following table, with the appropriate power cable type for your country.



Plug configuration	Standards	Rating, color and length	Model number (Option number)
	PSE: Japan Electrical Appliance and Material Safety Law	125 V at 7 A Black 2 m (6 ft)	Straight: A01402 Angled: A01412
	UL: United States of America CSA: Canada	125 V at 7 A Black 2 m (6 ft)	Straight: A01403 (Option 95) Angled: A01413
	CEE: Europe DEMKO: Denmark NEMKO: Norway VDE: Germany KEMA: The Netherlands CEBEC: Belgium OVE: Austria FIMKO: Finland SEMKO: Sweden	250 V at 6 A Gray 2 m (6 ft)	Straight: A01404 (Option 96) Angled: A01414
	SEV: Switzerland	250 V at 6 A Gray 2 m (6 ft)	Straight: A01405 (Option 97) Angled: A01415
	SAA: Australia, New Zealand	250 V at 6 A Gray 2 m (6 ft)	Straight: A01406 (Option 98) Angled: -----
	BS: United Kingdom	250 V at 6 A Black 2 m (6 ft)	Straight: A01407 (Option 99) Angled: A01417
	CCC: China	250 V at 10 A Black 2 m (6 ft)	Straight: A114009 (Option 94) Angled: A114109

Table of Power Cable Options

There are six power cable options (refer to following table).

Order power cable options by Model number.

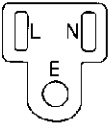
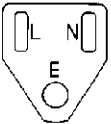
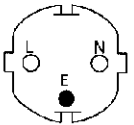
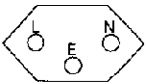
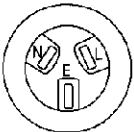
	Plug configuration	Standards	Rating, color and length	Model number (Option number)
1		JIS: Japan Law on Electrical Appliances	125 V at 7 A Black 2 m (6 ft)	Straight: A01402 Angled: A01412
2		UL: United States of America CSA: Canada	125 V at 7 A Black 2 m (6 ft)	Straight: A01403 (Option 95) Angled: A01413
3		CEE: Europe DEMKO: Denmark NEMKO: Norway VDE: Germany KEMA: The Netherlands CEBEC: Belgium OVE: Austria FIMKO: Finland SEMKO: Sweden	250 V at 6 A Gray 2 m (6 ft)	Straight: A01404 (Option 96) Angled: A01414
4		SEV: Switzerland	250 V at 6 A Gray 2 m (6 ft)	Straight: A01405 (Option 97) Angled: A01415
5		SAA: Australia, New Zealand	250 V at 6 A Gray 2 m (6 ft)	Straight: A01406 (Option 98) Angled: -----
6		BS: United Kingdom	250 V at 6 A Black 2 m (6 ft)	Straight: A01407 (Option 99) Angled: A01417

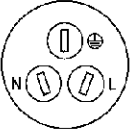
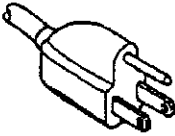
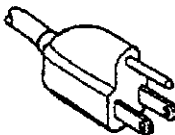
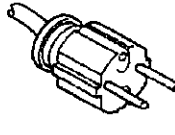
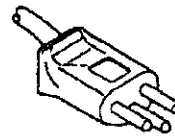
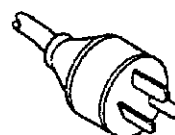
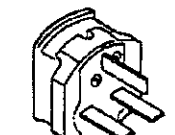
CONTENTS

SECTION 1 GENERAL INFORMATION

- 1-1. General 1-1
- 1-2. Caution 1-2

SECTION 2 SPECIFICATIONS

- 2-1. Electrical Performance 2-1
- 2-2. General Specifications 2-3
- 2-3. Options 2-4
- 2-4. Accessories Supplied 2-5

SECTION 3 OPERATIONS

- 3-1. Preparation and Cautions before Use 3-1
- 3-2. Description of Panels 3-5
- 3-3. Basic Operating Procedure 3-12
 - 3-3-1. Self-diagnostics Function 3-12
 - 3-3-2. Error Messages 3-13
 - 3-3-3. Panel Switch Check 3-14
 - 3-3-4. Frequency Measurement 3-15
 - 3-3-5. Period Measurement 3-18
 - 3-3-6. Time Interval Measurement 3-18
 - 3-3-7. Frequency Ratio Measurement 3-19
 - 3-3-8. Totalize 3-20
 - 3-3-9. Masking 3-21
 - 3-3-10. High-frequency Fuse Replacement 3-22

SECTION 4 GPIB INTERFACE

- 4-1. Introduction 4-1
- 4-2. General Outline of the GPIB 4-1
- 4-3. Specifications 4-3
- 4-4. Data Formats 4-5
- 4-5. GPIB Operating Procedures 4-10
- 4-6. Programming Notes 4-15

SECTION 5 PRINCIPLES OF OPERATIONS

5-1. Introduction	5-1
5-2. Operation of Each Block	5-1
5-3. Measurement Accuracy	5-7

SECTION 6 CALIBRATION

6-1. Introduction	6-1
6-2. Calibration for Each Section	6-1
6-3. Equipment Required for Calibration	6-2
6-4. Influence of Temperature and Line Voltage Variations on Stability	6-5

SECTION 7 CALCULATION UNIT TR1644 (ACCESSORY)

7-1. Name and Function of Keyboard	7-1
7-2. Calculation Unit Installation	7-2
7-3. Operating Examples	7-4
7-4. Notes on Use	7-5

SECTION 8 OPTIONS

8-1. BCD Output	8-1
8-2. D/A Converter	8-5
8-3. High-stability Reference Oscillator (TR5823 only) . . .	8-6

APPENDIX A TABLE OF SIGNALS

Rackmounting
External View

LIST OF FIGURES

Figure		Page
3-1	Power cable plug and adapter	3-2
3-2	Panels description	3-6
3-3	Panels description (TR5823)	3-9
3-4	Self-check routine	3-12
3-5	Frequency measurement (FREQ. A)	3-15
3-6	Frequency measurement (FREQ. B)	3-15
3-7	Frequency measurement (FREQ. C)	3-16
3-8	Burst measurement	3-17
3-9	Period measurement	3-18
3-10	Time interval measurement	3-18
3-11	Frequency ratio measurement	3-19
3-12	Totalize measurement	3-20
4-1	GPIB outline	4-2
4-2	Signal line termination	4-3
4-3	GPIB connector pin assignment	4-4
4-4	Retention of remote setting	4-11
4-5	GPIB interface panel	4-12
5-1	TR5821/5822/5823 block diagram	5-2
5-2	LSI80-GC and LSI80-SS	5-6
5-3	Number of periods with time & frequency	5-9
5-4	Slew rate vs. amplitude & frequency	5-10
5-5	Period/time interval averaging	5-10
6-1	Calibration using frequency standard	6-3
6-2	Automatic trigger adjustment	6-4
6-3	Stability of reference oscillator	6-5
7-1	Panel description	7-1

LIST OF TABLE

Table		Page
3-1	Setting for AC line voltage	3-3
3-2	Error message types and error locations	3-13
4-1	Interface functions	4-4
4-2	Standard bus cables	4-10
4-3	Address code table	4-13

SECTION 1 GENERAL INFORMATION

1-1. General

The **TR5821/5822/5823/5823H** are compact, inexpensive universal counters with the capabilities comparable to medium-scale counters. These are the first universal counters that became possible to process data with a self-diagnostic function and various operations (by using **TR1644**). Since GPIB, BCD (TTL) output, and analog output (D/A converter) are available, these equipments can support various system.

TR5821 is a universal counter that can measure frequencies of up to 120 MHz, and can display results in arbitrary form with **TR1644** (an extra-cost option).

The **TR5822** has the same functions as the **TR5821** plus a built-in GPIB interface, and the functions of the **TR5823** include an ultrahigh-frequency measurement (1.3 GHz) and a burst signal measurement in addition to the functions of the **TR5821**.

The **TR5823H** is provided with the high-stability oscillator (aging rate: 5×10^{-8} /day) as a standard feature plus the capabilities of the **TR5823**.

* The **TR5823** described in this manual also includes the functions of the **TR5823H**.

1-2. Caution

1. With **POWER ON**, self-check is automatically initiated; any failure will produce an error message "**E01, E07, E10**" for about 2s. When **POWER** is **ON** after **RESET ON**, check of panel switches is performed (See instruction manual 3-3-3 for details).
2. When a panel switch is pressed, function is selected and the instrument is in the standby state; when released, operation is started in the **TOT.** mode, totalize operation continues but display is held while the **ON/OFF** switch is being pressed (**GATE** lamp on); when released (**GATE** lamp off), totalized result is displayed.
3. Though selectable by function selector switch, ◀▶ position on **TR5821/5822** is not used. Move to any other position.
4. In case of frequency measurements (**FREQ.B/TR5821, TR5822, TR5823, TR5823H**), when the rapid switching of input frequency happen, the timing of switched frequency may cause, the measurement time to get longer.
5. Damage input levels are shown as follow.

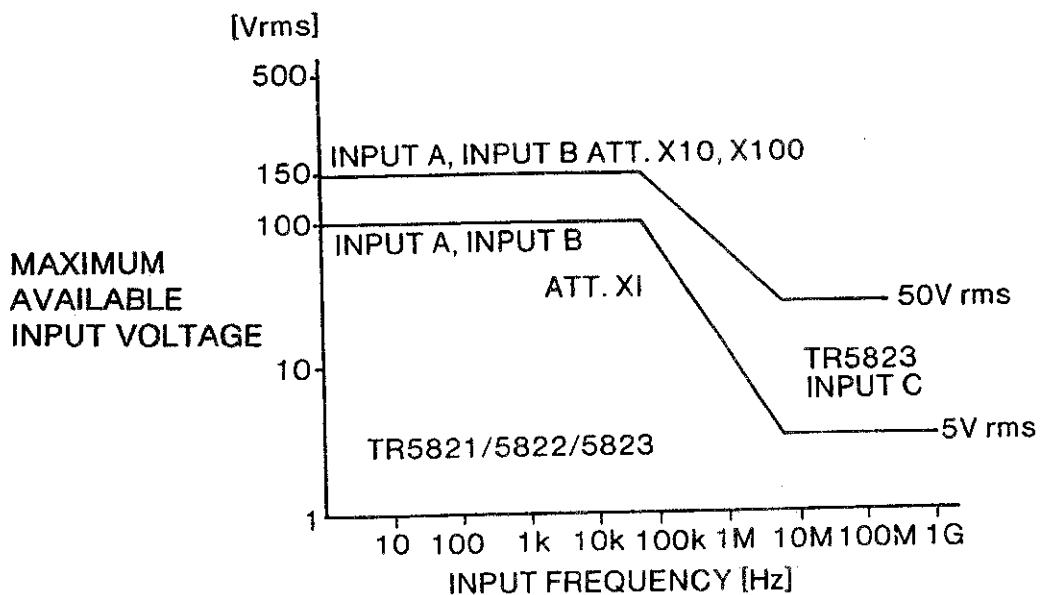

SECTION 2 SPECIFICATIONS

2-1. Electrical Performance

Frequency measurement (FREQ. A)

Range : 10 Hz to 120 MHz
Gate time : 10 ms, 0.1 s, 1 s, or 10 s
Unit display : Hz, kHz, or MHz
Accuracy : ± 1 count \pm time base accuracy

Frequency measurement (FREQ. B)

Range : 1 mHz to 50 MHz
Gate time : 10 ms (9 ms to 0.1 s), or 1 period time of input frequency below 10 Hz. Five display digits.
0.1 s (90 ms to 1 s), or 1 period time of input frequency below 1 Hz. Six display digits.
1 s (0.9 s to 10 s), or 1 period time of input frequency below 0.1 Hz. Seven display digits.
10 s (9 s to 100 s), or 1 period time of input frequency below 10 mHz. Eight display digits.

Unit display : mHz, Hz, kHz, or MHz

Accuracy : \pm (Trigger error/ 10^m) ± 1 count \pm time base accuracy
Where 10^m is the number of periods. See 5-3-2.

Note: When the rapid switching of input frequency happen, the timing of switched frequency may cause, the measurement time to get longer.

Frequency measurement (FREQ. C) (TR5823)

Range : 100 MHz to 1300 MHz (1/20 prescaled)
Gate time : 20 ms, 0.2 s, 2 s, or 20 s
Unit display : Hz, kHz, MHz, or GHz
Accuracy : ± 1 count \pm time base accuracy

Period measurement (PERIOD B)

Measurement range: 20 ns to 999.99999 s (including when averaged)
Multiplier (10^n) : 10^0 , 10^1 , 10^2 , or 10^3
Time unit : 100 ns
Unit display : ns, μ s, ms, or s
Accuracy : \pm (Trigger error/ 10^n) ± 1 count \pm time base accuracy

Time interval measurement (T.I. A → B)

Range : 200 ns to 999.99999 s
Multiplier (10^n) : 10^0 , 10^1 , 10^2 , or 10^3
Time unit : 100 ns
Unit display : ns, μ s, ms, or s
Accuracy : \pm (Trigger error/ $\sqrt{10^n}$) \pm 1 count \pm time base accuracy
Dead time : 50 ns

Frequency ratio measurement (RATIO A/B)

Range : DC to 50 MHz
Multiplier (10^n) : 10^0 , 10^1 , 10^2 , or 10^3
Unit display : m, k, or M
Accuracy : \pm (Input B trigger error/ 10^n) \pm 1 count \pm Input A accuracy

Totalize (TOT. A)

Range : DC to 50 MHz, 0 to 99999999

Input Specifications

INPUT A/B

Input sensitivity : 25 mVrms, DC to 100 MHz
55 mVrms, 100 MHz to 120 MHz
Sensitivity switching : $\times 1$, $\times 10$, and $\times 100$
Input voltage range : 25 mVrms to 500 mVrms (at $\times 1$)
Damaging input level : DC to 100 kHz: 100 Vrms ($\times 1$), 150 Vrms ($\times 10$ or $\times 100$)
100 kHz to 120 MHz: 5 Vrms ($\times 1$), 50 Vrms ($\times 10$ or $\times 100$)
Input coupling mode : DC or AC coupled, or AUTO (AC coupled)
Input impedance : Approx. $1\text{ M}\Omega//30\text{ pF}$, COM. A approx. $500\text{ k}\Omega$
Pulse resolution : 10 ns
Trigger level : Approximately -1 V to $+1\text{ V}$ continuously variable.
In the **AUTO** mode, the trigger level is automatically set to the half-amplitude of the peak value of the signal to be measured.
Trigger slope : \pm switchable
Common/Separate : **COM.** handles inputs A and B as common input.
SEP. handles inputs A and B separately.
Masking : Approx. 0.1 ms to 0.1 s. The masking time can be monitored at CHECK mode.
Noise rejection : 100 kHz low-pass filter

INPUT C (TR5823 only)

Input sensitivity : 20 mVrms, 100 MHz to 1300 MHz
Sensitivity switching : x1 and x10
Input voltage range : 20 mVrms to 500 mVrms (at x1)
Damaging input level : 5 Vrms (with protection fuse)
Input coupling mode : AC coupled
Input impedance : 50 Ω
Burst mode : **BURST** switch operation enables burst signal measurement.
Noise rejection : Automatically suppressed by ANS (Automatic Noise Suppressor) (ON-OFF switching)

Time Base

Internal reference frequency : 10 MHz
Frequency stability : Aging rate: $\pm 5 \times 10^{-7}$ /month
Temperature stability: $\pm 5 \times 10^{-6}$ (0°C to $\pm 40^{\circ}\text{C}$)
Line voltage: $\pm 2.5 \times 10^{-7}$ (100 V \pm 10%)
Internal reference output: Frequency: 10 MHz
Output voltage: 1 V_{p-p} to 2 V_{p-p}
Output impedance: approx. 500 Ω
External reference input: Frequency: 10 MHz
Input voltage: 1 V_{p-p} to 10 V_{p-p}
Input impedance: approx. 500 Ω

2-2. General Specifications

Display : 8 decimal digits
Green, 7-segment LED, display storage method
Sample rate : 50 ms or hold
Self-check : Counting operation check by internal reference signals
Operating environment : Temperature: 0°C to $+40^{\circ}\text{C}$
Relative humidity: 85% or less
Storage temperature : -20°C to $+70^{\circ}\text{C}$
Power requirements : 90 – 110 V, 108 – 132 V, 198 – 242 V, 216 – 250 V
50 Hz to 400 Hz,
Power consumption: 40 VA or less (TR5821/22/23)
Dimensions : (W)240 x (H)88 x (D)280 mm approx.
Mass : 3.5 kg or less (TR5821)
4 kg or less (TR5822/5823)

2-3. Options

GPIB data output & remote control

Standard : IEEE STD. 488-1978
Interface functions : Source and acceptor handshake
Talker/listener
Service request
Device clear
Code used : ASCII code
Remote-programmable functions : Function
Gate time/Multiplier
Hold

BCD data output

Data : Digit parallel
Output digits: Mantissa 7 digits, exponent 1 digit
Output level : TTL, positive logic

D/A converter (requires TR1644)

Output voltage : 0.999 V full-scale
Conversion digits : Any 3 consecutive digits
Output terminal : Binding post
Output impedance : Approx. 1 k Ω

DA output is not done at the function of TOT.

High-stability reference oscillator

Stability : Aging rate: 5×10^{-8} /day
Temperature characteristics: $\pm 1 \times 10^{-7}$, 0°C to +40°C

The internal reference output and external reference input specifications are the same as the standard time base.

TR1644 Calculation Unit

Math mode : \pm (addition, subtraction), \times (multiplication), \div (division),
DAC (D/A converter mode), comparison, delta, Max., Min.,
%, scaling, arithmetic operation between set values by using
= key (\pm , \times , \div)
Digit : Setting: Mantissa 8 digits, exponent 1 digit
Display: 8 digits

Option combinations

Only one kind of interface can be attached to all products except for TR5821.
(Options to be installed in ADVANTEST side)

Name of type	Product code	Built-in interface
TR5822	5822-GP 5822-BCD 5822-DA	Equipped with GPIB Equipped with BCD output Equipped with D/A converter (TR1644 must be prepared separately)
TR5823	5823 5823-GP 5823-BCD 5823-DA	Equipped with GPIB Equipped with BCD output Equipped with D/A converter (TR1644 must be prepared separately)
TR5823H	5823H 5823H-GP 5823H-BCD 5823H-DA	Equipped with GPIB Equipped with BCD output Equipped with D/A converter (TR1644 must be prepared separately)

2-4. Accessories Supplied

(1)	Power cable *1	1
(2)	Input cable (A01036-1500)	1
(3)	Input cable (MI-03)	1
(4)	Slow-blow fuse (T0.4A) (AC100/120 V ac)*2	2
(5)	High-frequency fuse (TR5823/5823H only)	2
(6)	Instruction Manual	1
(7)	Carrying Case (TR16202) (To be purchased separately)	1

*1: ADVANTEST provides the power cables for each country.

*2: T0.2A for 220, 240 V ac

SECTION 3 OPERATIONS

3-1. Preparation and Cautions Before Use

3-1-1. Inspection

After receiving this unit, check it for any damages that may have occurred during transit, especially for damage of panel switches and terminals. Should any damage be found or if the unit does not operate as specified, contact your nearest ADVANTEST representative.

3-1-2. Storage

For long-term storage, place the unit in a vinyl cover or cardboard box and store it at low-humidity out of direct sunlight.

3-1-3. Transportation

To transport this unit, use the original packing. If the packing has been discarded, pack it as follows:

- (1) Wrap the unit in a vinyl.
- (2) Place the unit in a cardboard box having walls at least 5 mm thick. Place packing of 40 mm or thicker under, all around, and over the unit.
- (3) After covering the unit with packing, fit the accessories in the box and place packing over them. Close the cardboard box, then secure the box with packing tape.

3-1-4. General Cautions Before Use

(1) Power supply

The power voltage has been set at factory; it is indicated above the power cable on the rear panel. Use a power supply of 100 V ac \pm 10%, or 120/220 V ac \pm 10%, 240 V ac +4%, -10% at a frequency of 50 Hz to 400 Hz. Check that the **POWER** switch is set to **STBY** before connecting the power cable to the power source.

(2) Power cable

The power cable has a 3-prong plug; the round prong in the center is for ground. When connecting the plug to the power receptacle via an adapter, connect the wire leading out of the adapter to ground.

(See Figure 3-1.)

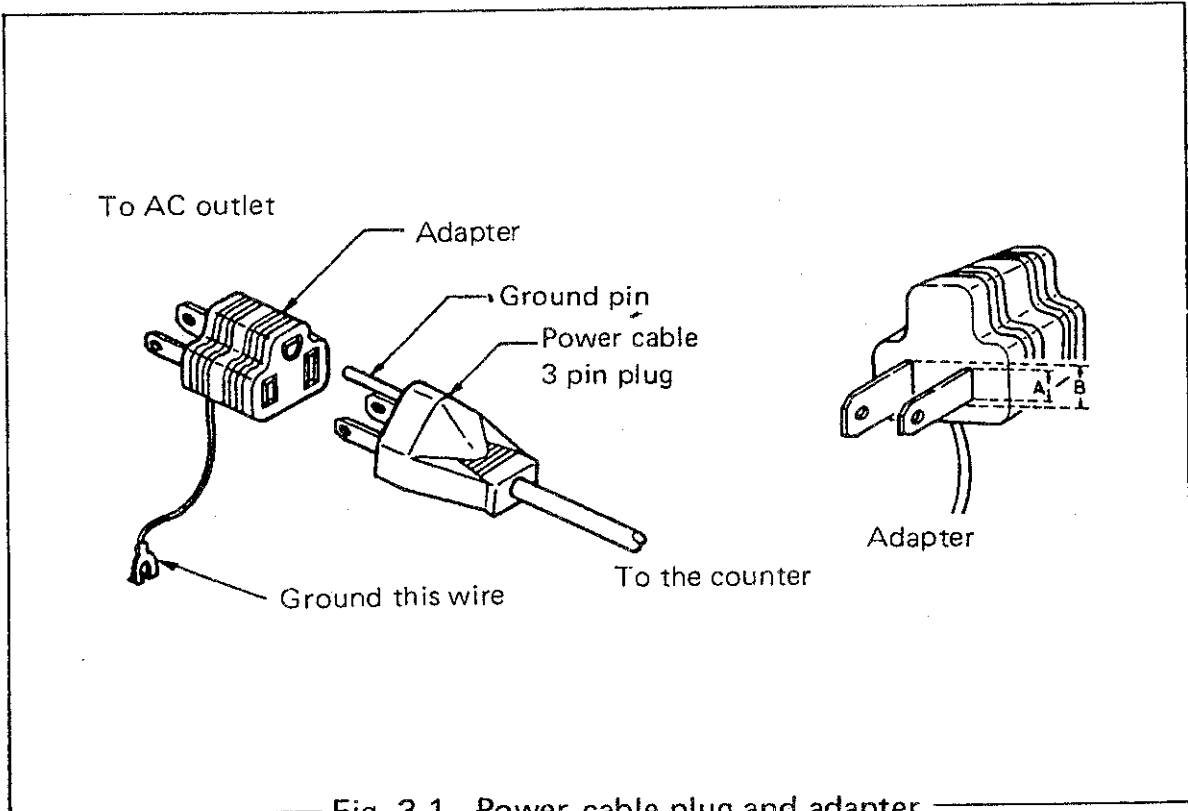

Fig. 3-1 Power cable plug and adapter

(3) Replacement of a fuse

A fuse is installed into the outlet on the rear panel. The check or replacement of the fuse should be done as follows. (Applicable fuses are shown in Table 3-1.)

To change an AC line voltage, pull the voltage selector out with a pair of long-nose pliers and so on, and then set the AC line voltage. You can see the selected AC line voltage on the face of the voltage selector.

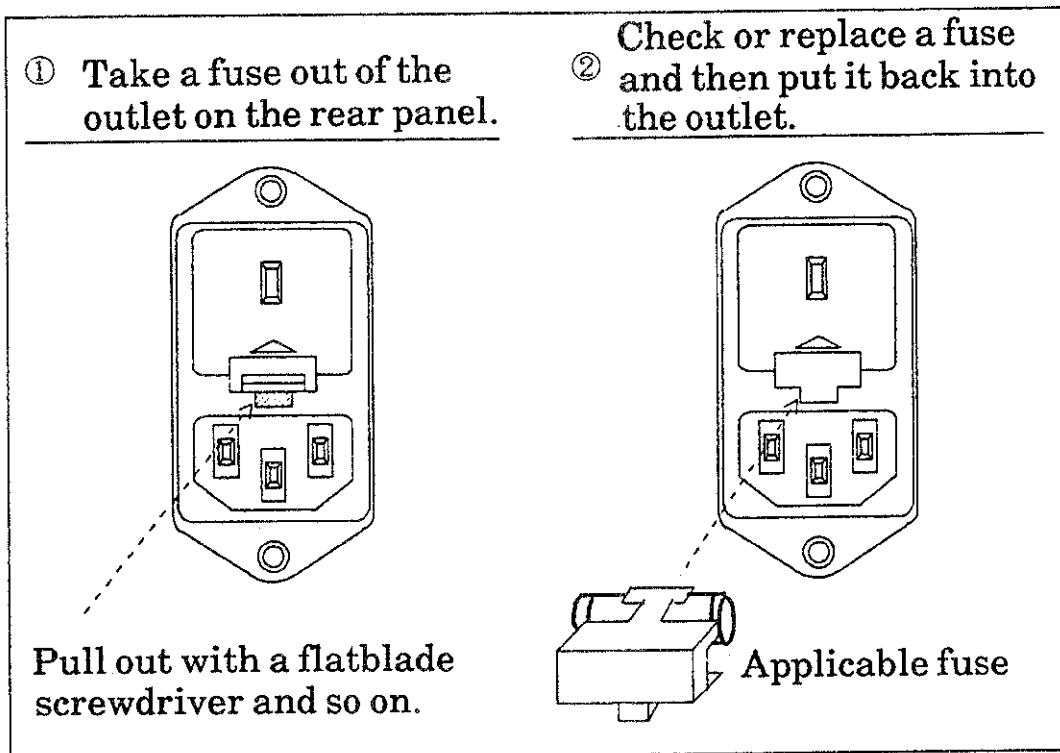

Table 3 – 1 Setting for AC line voltage

AC line voltage	Display of set voltages	Applicable fuse
100 V	100	T 0.4A / 250 V
120 V	120	
220 V	220	T 0.2A / 250 V
240 V	240	

(4) Operating environment

Use this unit in a location free from dust, direct sunlight, and corrosive gases. The environmental conditions for use are a temperature of 0°C to +40°C and a relative humidity of 85% or lower.

(5) Shock

This unit has a crystal oscillator; so do not subject it to strong mechanical shock.

(6) **STBY**

When the power cable plug is connected to a power receptacle, the reference oscillation circuit starts operation and the unit enters the standby state; measurement is enabled immediately after the unit is **POWERed ON**. Since the reference oscillator is not temperature compensated, the frequency fluctuates as shown in Figure 6-2 after **POWER ON**, even if the unit has been set to **STBY** with the power cable plug connected to a power receptacle.

(7) Selection of time base signal

Either the external or internal time base signal can be used by operating the **INT. STD OUT./EXT. STD IN.** switch on the rear panel. **INT. STD OUT.** selects the internal time base signal and outputs it. **EXT. STD IN.** allows input of an external time base signal (1 V_{p-p} to 10 V_{p-p}, 500 Ω, 10 MHz).

3-2. Description of Panels

3-2-1. TR5821/5822 Panels (To see Figure 3-2.)

① Power

The mainframe is not powered when the **POWER** switch is set to **STBY**, but the reference oscillator is activated in this state if the power cable plug is connected to a power receptacle. The mainframe is powered when the **POWER** switch is set to **ON**.

② FUNCTION

Every time is pressed, the lamp indication changes **CHECK** → **FREQ.** → **PERIOD** → **T.I.** → **RATIO** → . . . cyclically, and the function indicated by the lighted lamp is selected; key operation shifts the lamp indication in the opposite direction. When **TOT.** is selected, the gate opens/closes each time is pressed. For other functions, the switch operates as a **RESET** switch. (See ②1 for **RESET**.)

③ GATE

Monitor lamp for counting operation. The lamp is on during counting (measurement).

When counting operation is done at high speed, the **MONITOR** lamp lights at short time intervals and seems to disappear.

④ OVER

This lamp goes on when the measurement result exceeds the counting capacity.

⑤ Numerical display section

Green, 7-segment LED display of 8 digits.

⑥ Unit display section

Displays the unit of the measurement result.

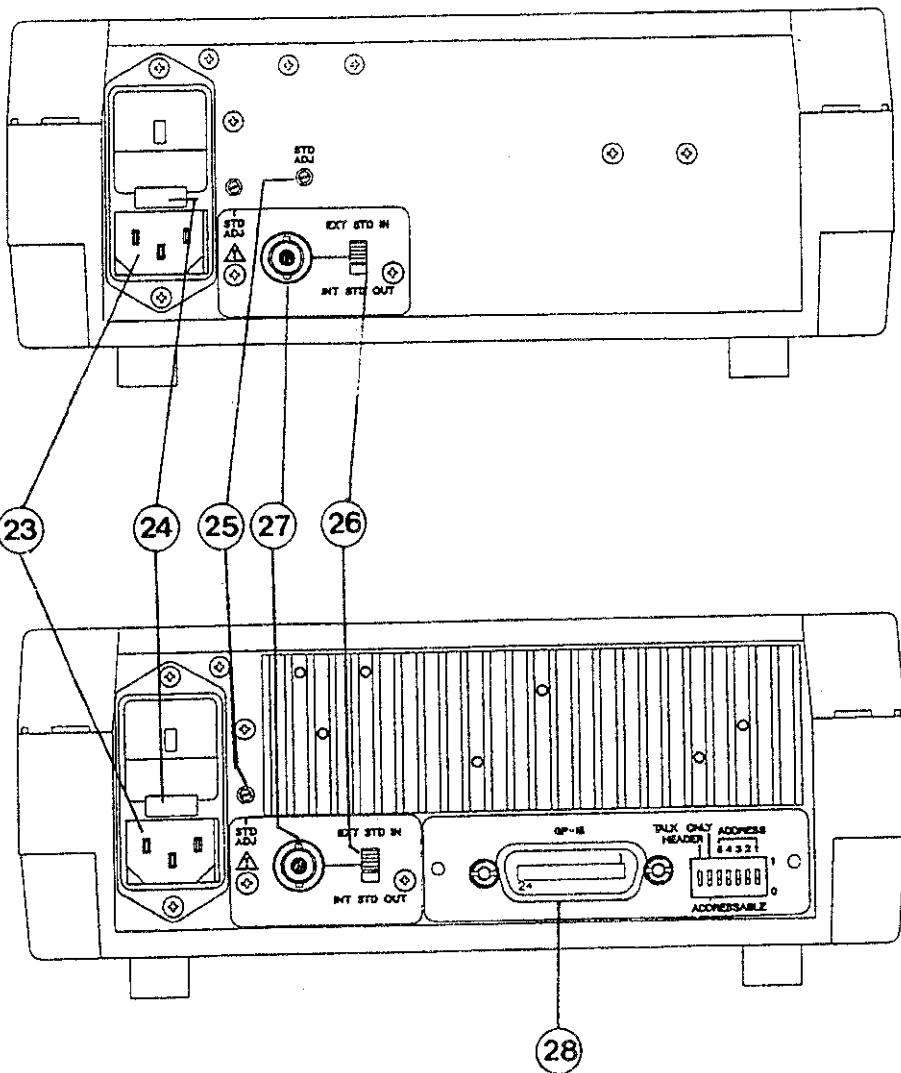
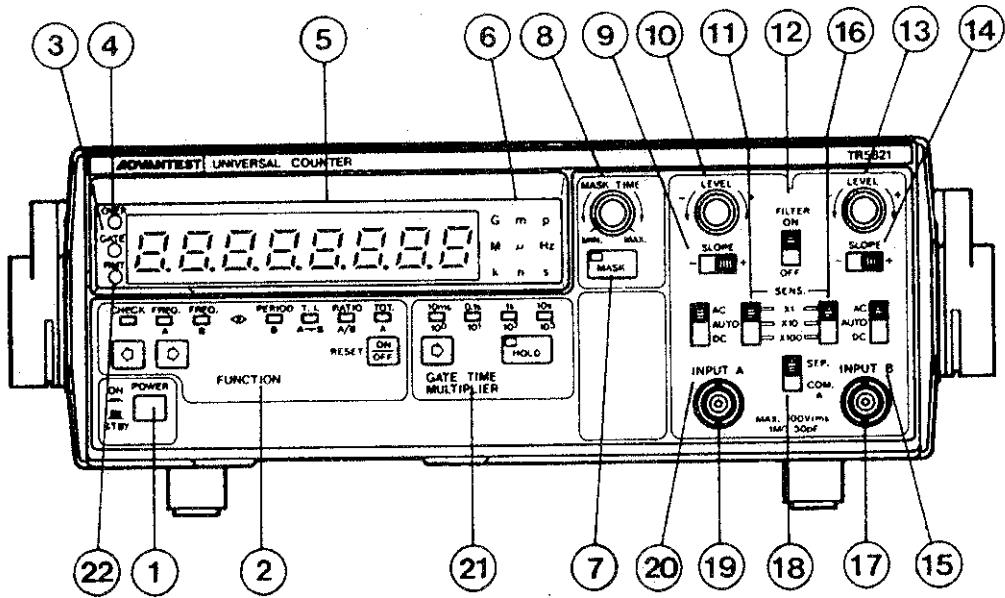





Fig. 3-2 Panel description

- ⑦ **MASK**
The signal to be measured is masked by pressing  to light the lamp within the switch. Set the masking time with control ⑧. (**FREQ. A** cannot be masked.)
- ⑧ **MASK TIME**
A control for setting the masking time.
- ⑨ **SLOPE**
Trigger point slope selector switch. + sets the trigger point at the positive slope and - sets it at the negative slope.
- ⑩ **LEVEL**
A control for triggering the signal to be measured at the proper level. The trigger voltage can be adjusted within a range of about -1 V to +1 V.
- ⑪ **SENS.**
Selects the input sensitivity.
- ⑫ **FILTER**
When the switch is set **ON**, the 100 kHz (approx.) low-pass filter is activated on both A and B channels.
- ⑬ **LEVEL**
See ⑩.
- ⑭ **SLOPE**
See ⑨.
- ⑮ **AC-AUTO-DC**
Input coupling selector switch. **AC** and **AUTO** cut out the DC component and routes the AC component into the input circuit. **AUTO** automatically sets the trigger voltage to the 50% level of the voltage to be measured. **DC** routes both AC and DC components into the input circuit.
- ⑯ **SENS.**
See ⑪.
- ⑰ **INPUT B**
Channel B input connector.
- ⑱ **SEP./COM. A**
SEP. is used for two separate inputs A and B, whereas with **COM. A** the signal to be measured on channel A is common to both channels.

- ①9 **INPUT A**
Channel A input connector.
- ②0 **AC-AUTO-DC**
See ①5.
- ②1 **GATE TIME/MULTIPLIER**
For setting the gate time (**CHECK, FREQ. A, FREQ. B**) or average measurement time multiplier (**PERIOD, T.I., RATIO**). Each time  is pressed, the lamp indication shifts $10\text{ms}/10^0 \rightarrow 0.1\text{s}/10^1 \rightarrow 1\text{s}/10^2 \rightarrow 10\text{s}/10^3 \rightarrow 10\text{ms}/10^0 \rightarrow \dots$ cyclically, and the gate time or the multiplier is set to the value indicated by the lighted lamp. When  is pressed (the lamp within the switch goes on), counting is made once, then stops. Each time **RESET** is pressed in the hold state, a counting is made, then stops. When  is pressed again, the lamp within the switch goes off and the hold function is deactivated. **RESET** initializes the operation of this unit (without changing the functions).
- ②2 **RMT**
The lamp goes on when this unit is in the remote state. In this case, no operation is made when a panel switch is pressed. (For GPIB remote control)
- ②3 **AC 100 V**
Indicates the available voltage. Use 100/120/220 V ac at $\pm 10\%$, or 240 V ac $+4\%$, -10% .
- ②4 **T 0.4 A**
Indicates the rating of the fuse in use. Use a 0.4 A slow-blow fuse for 100/120 V ac; use a 0.2A slow-blow fuse for 220/240 V ac.
- ②5 **STD ADJ.**
Trimmer for adjusting the internal reference oscillator.
- ②6 **INT. STD OUT./EXT. STD IN.**
Internal reference oscillator and external reference signal selector switch. **INT. STD OUT.** selects the internal reference oscillator and outputs the frequency value at ②7. When **EXT. STD IN.** is selected, the external reference signal fed to ②7 operates this unit.
- ②7 Reference signal I/O connector. See ②6.
- ②8 **GPIB connector**
GPIB connector is used to connect this unit to the GPIB interface for externally controlling function, gate time/multiplier, hold of this unit.

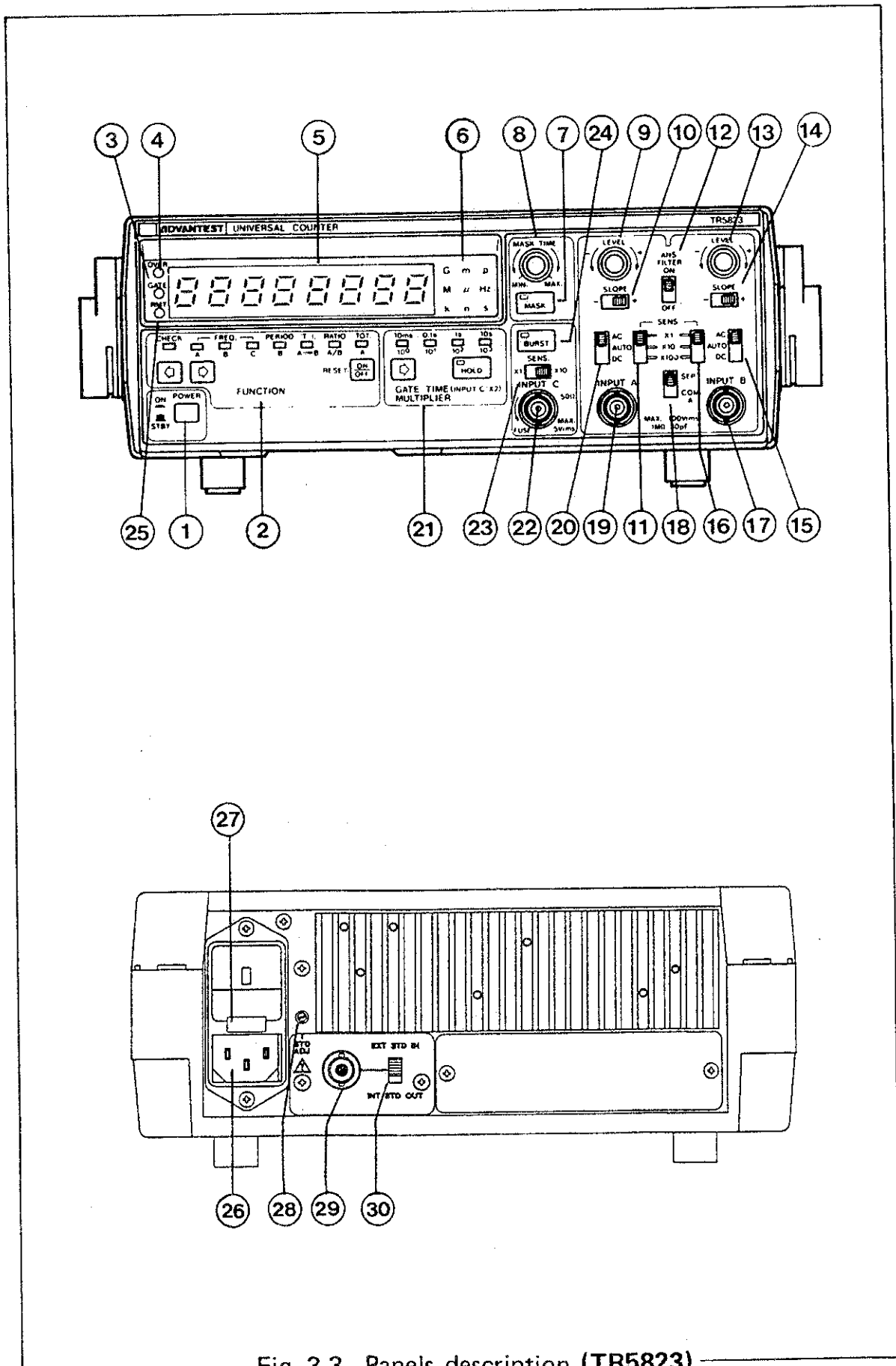





Fig. 3-3 Panels description (TR5823)

3-2-2. TR5823 Panels (To see Figure 3-3.)

① POWER

The mainframe is not powered when the **POWER** switch is set to **STBY**, but the reference oscillator is activated in this state if the power cable plug is connected to a power receptacle. The mainframe is powered when the **POWER** switch is set to **ON**.

② FUNCTION

Each time  is pressed, the lamp indication changes **CHECK** → **FREQ.** → **PERIOD** → **T.I.** → **RATIO** → ... cyclically, and the function indicated by the lighted lamp is selected;  key operation shifts the lamp indication in the opposite direction. When **TOT.** is selected, the gate opens/closes each time  is pressed. For other functions, the  switch serves as a **RESET** switch. (See ⑪ for **RESET**.)

③ GATE

Monitor lamp for counting operation. The **GATE** lamp is on during counting (measurement).

④ OVER

This lamp goes on when the measurement result exceeds the counting capacity.

⑤ Number display section

Green, 7-segment LED display of 8 digits.

⑥ Unit display section

Displays the unit of the measurement result.

⑦ MASK

The signal to be measured is masked by pressing  to light the lamp within the switch. Set the masking time with the control ⑧ (**FREQ. A** and **FREQ. C** cannot be masked.)

⑧ MASK TIME

A control for setting the masking time.

⑨ LEVEL

A control for triggering the signal to be measured at the proper level. The trigger voltage can be adjusted within a range of about $-1V$ to $+1V$.

⑩ SLOPE

Trigger point slope selector switch. + sets the trigger point at the positive slope and - sets it at the negative slope.

⑪ SENS.

Selects the input sensitivity.

- ⑫ **ANS/FILTER**
When this switch is set to **ON**, the 100 kHz (approx) low-pass filter is activated on both A and B channels, and ANS of channel C is set to ON.
- ⑬ **LEVEL**
See ⑨.
- ⑭ **SLOPE**
See ⑩.
- ⑮ **AC-AUTO-DC**
Input coupling selector switch. **AC** and **AUTO** cut out the DC component and routes the AC component into the input circuit. **AUTO** automatically sets the trigger voltage to the 50% level of the voltage to be measured. **DC** routes both AC and DC components into the input circuit.
- ⑯ **SENS.**
Selects the input sensitivity.
- ⑰ **INPUT B**
Channel B input connector.
- ⑱ **SEP./COM. A**
SEP. is used for two separate inputs A and B, whereas with **COM. A** the signal to be measured on channel A is common to both channels.
- ⑲ **INPUT A**
Channel A input connector.
- ⑳ **AC-AUTO-DC**
See ⑮.
- ㉑ **GATE TIME/MULTIPLIER**
Same as ㉑ in 3-2-1 "TR5821/22 Panels." For **FREQ. C**, the gate time becomes twice as long.
- ㉒ **INPUT C**
Channel C input connector.
- ㉓ **SENS.**
See ⑯.
- ㉔ **BURST**
When  is pressed, the lamp within the switch goes on and burst signal measurement is enabled. The measurement starting point can be changed by using the **MASK** switch.
- ㉕ **RMT**
Same as ㉒ in 3-2-1 "TR5821/5822 Panels."
- ㉖ to ㉓ **to ㉓**
Same as ㉓ to ㉗ in 3-2-1 "TR5821/5822 Panels."

3-3. Basic Operating Procedure

This section explains how to use each function of the TR5820 series. Check the model name before operation. For convenience, the TR5823 is used in illustrations.

3-3-1. Self-diagnostics Function (CHECK)

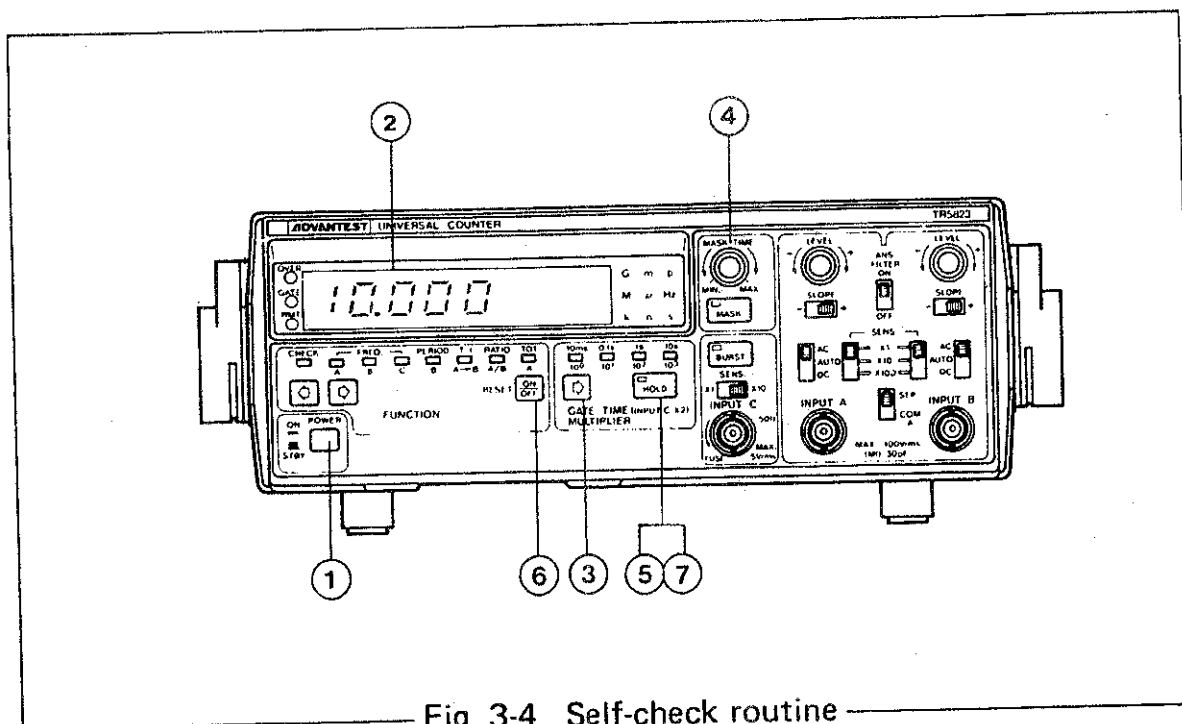

Fig. 3-4 Self-check routine

Check 3-1-4. "General Cautions Before Use" before powering the unit.

- ① **POWER ON** starts the self-diagnostics function which checks the micro-processor, two LSIs, and existence of the reference signals. When no error is found, all segments and indicator lamps (except the **GATE** lamp and decimal point) go on (about 2 seconds) for checking. Then, this unit is initialized to:





FUNCTIONCHECK
GATE TIME10 ms
 Other functionsOFF

- ② 10.000 MHz is displayed and the **GATE** lamp blinks.

- ③ Display readout changes as below with each press of **GATE TIME**

	10.000	MHz
<input type="checkbox"/> 0.1s	10.0000	MHz
<input type="checkbox"/> 1s	10.00000	MHz
<input type="checkbox"/> 10s	10.000000	MHz

Press again to set **GATE TIME** to 10 ms.

- ④ Press  to light the lamp within the switch. Turn the **MASK TIME** control to see that the display changes approximately 100 μ s to 100 ms. Press  to deactivate the masking function.
- ⑤ Press  to light the lamp within the switch; the **GATE** lamp goes off.
- ⑥ Press **RESET**; the **GATE** lamp blinks once.
- ⑦ Press  to release the hold; the **GATE** lamp starts blinking again.

3-3-2. Error Messages

An error message is displayed when an error is found during self-diagnostics and when an arithmetic operation or data setting error is found. A self-diagnostics error message is displayed for about 2 seconds, and the operation shifts to CHECK (some errors may cause it inoperative). When an arithmetic operation or data setting error message is displayed, the operation stops. Table 3-1 lists the error messages; the cause of each message may be found in any other place than those listed below.

Table 3-2 Error message types and error locations

Error message	Error location
E 01	Microprocessor (ROM, RAM)
E 07	Crystal oscillator or External reference signal is not provided with the selector switch being set to EXT.STD.IN.
E 10	Panel switch
E 21	No EXP at DAC
E 22	A· exists at DAC
E 23	Display upper limit exceeded
E 24	Display lower limit exceeded (See Note (9) on page 7-6.)
E 25	Measurement value or data is zero

Note on "E07" display: Disconnecting and reconnecting action of the power plug in less than 1-second interval with POWER switch ON may cause display of E07. This is not a functional error; it is displayed because the crystal oscillator takes time before it starts to oscillate.

3-3-3. Panel Switch Check

When the **POWER** switch is set to **ON** while the **RESET** key is pressed, the following is displayed and the operation enters the panel switch check mode:

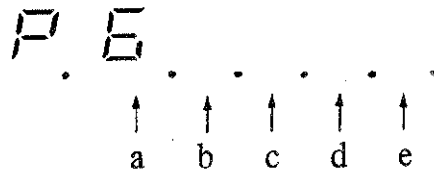

When each key is pressed, the number that corresponds to the key is displayed at the location indicated by a to e. If no number is displayed or a number that does not correspond to the key is displayed with press of a key, the cause is assumed to be a defective switch.

Digit Display	a	b	c	d	e
0	FUNCTION	0	5	±	=
1	FUNCTION	1	6	×	EXP
2	MASK	2	7	÷	SFT
3	BURST	3	8	DAC	C
4	GATE TIME	4	9	COM	RD
5	HOLD	.	+/-	OFF	EXE
6	RESET				

TR1644 keys

3-3-4. Frequency Measurement

(1) FREQ. A (10 Hz to 120 MHz) (TR5821/5822/5823)

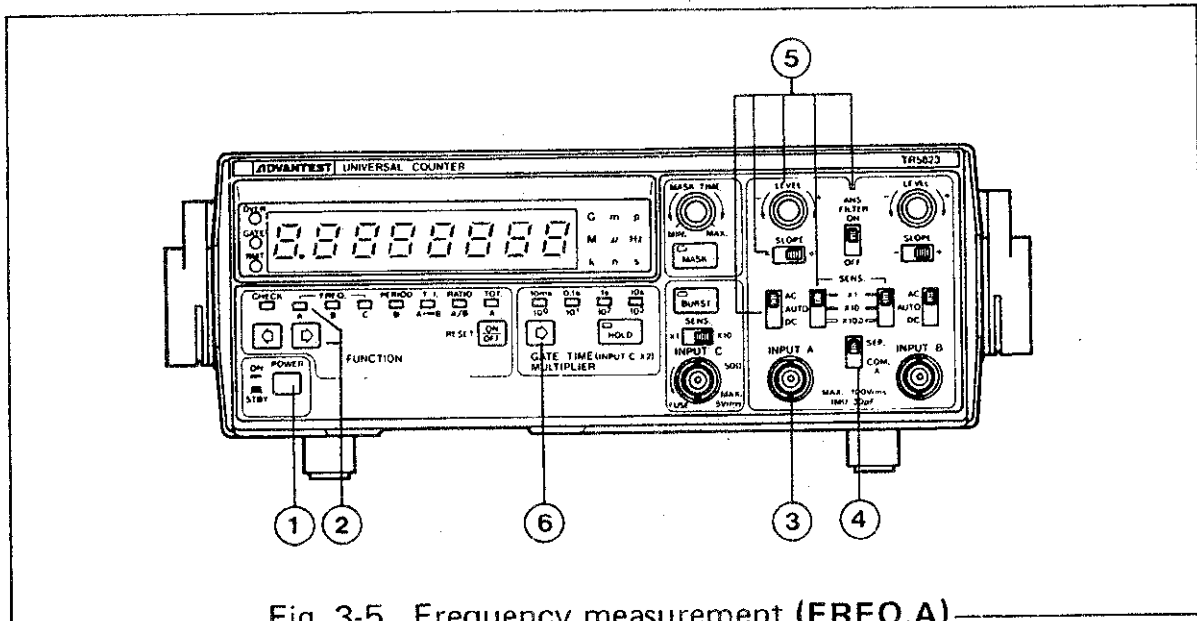

Fig. 3-5 Frequency measurement (FREQ.A)

- ① POWER ON and check for CHECK operation.
- ② Set FUNCTION to FREQ. A
- ③ Connect the signal to be measured to INPUT A.
- ④ Set the SEP./COM. A switch to SEP.
- ⑤ Set each switch according to the signal to be measured.
- ⑥ Select a GATE TIME according to the required precision.

(2) FREQ. B (1 mHz to 50 MHz) (TR5821/5822/5823)

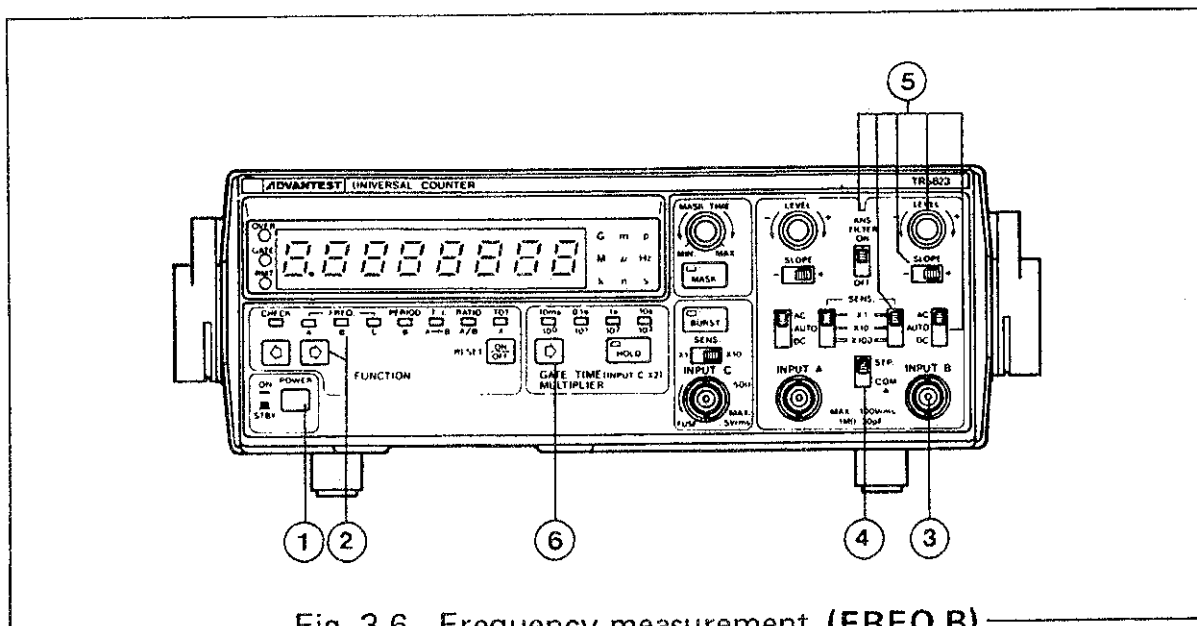

Fig. 3-6 Frequency measurement (FREQ.B)

- ① **POWER ON** and check for **CHECK** operation.
- ② Set **FUNCTION** to **FREQ. B**.
- ③ Connect the signal to be measured to **INPUT B**.
- ④ Set the **SEP./COM. A** switch to **SEP**.
- ⑤ Set each switch according to the signal to be measured.
- ⑥ Select a **GATE TIME** according to the required precision.

(3) **FREQ. C** (100 MHz to 1300 MHz) (TR5823)

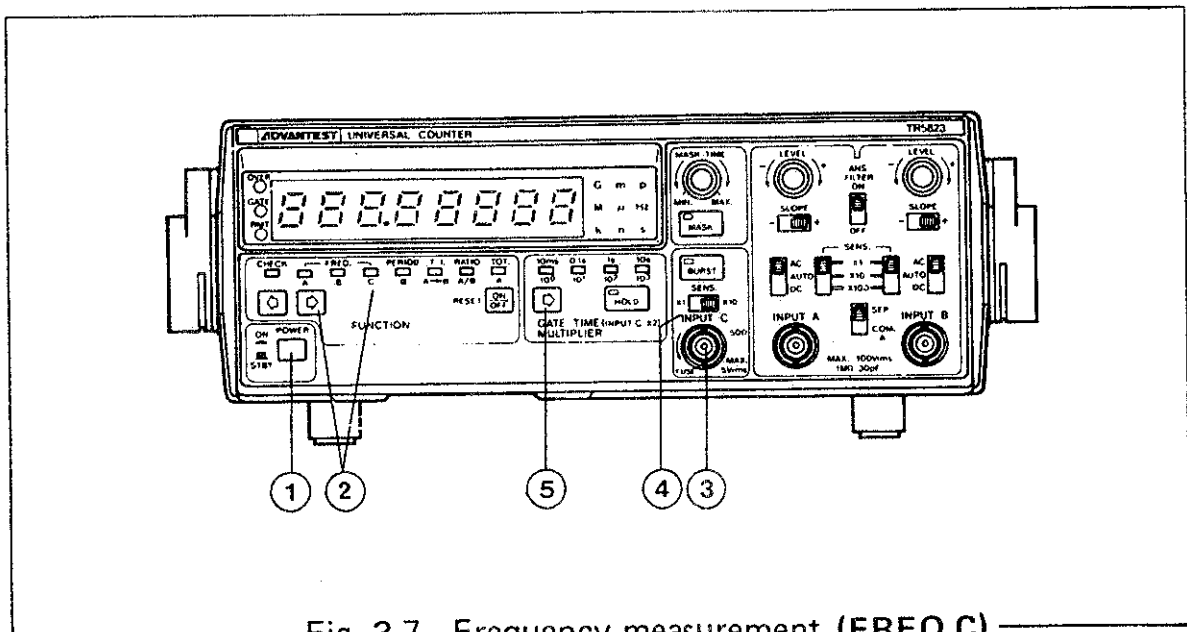

Fig. 3-7 Frequency measurement (FREQ.C)

- ① **POWER ON** and check for **CHECK** operation.
- ② Set **FUNCTION** to **FREQ. C**.
- ③ Connect the signal to be measured to **INPUT C**.
- ④ Set the input sensitivity according to the signal to be measured.
- ⑤ Select a **GATE TIME** according to the required precision. **GATE TIME** for **FREQ. C** will be 20 ms, 0.2 s, 2 s, 20 s, respectively.

(4) Burst measurement (FREQ. C) (TR5823)

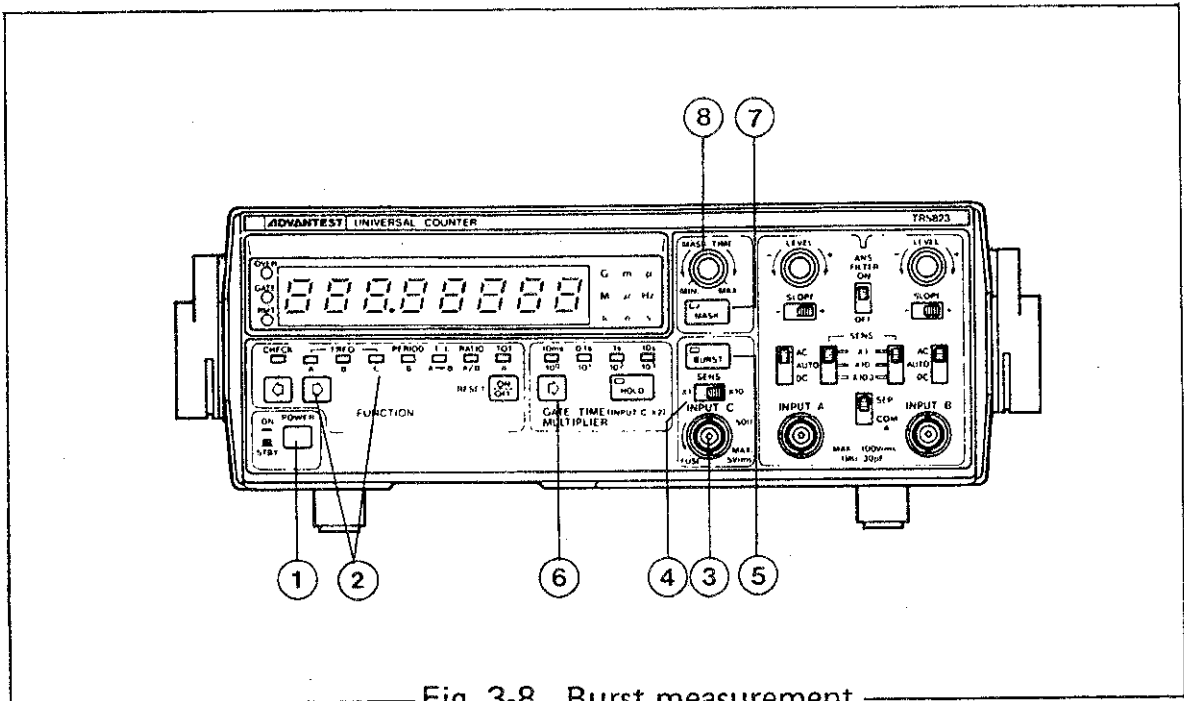
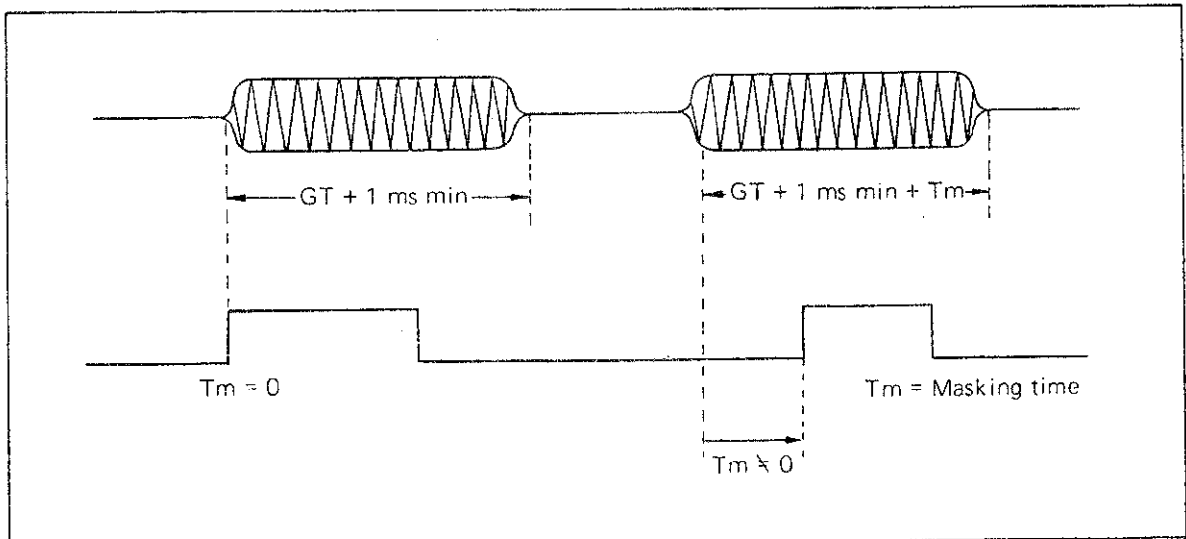

Fig. 3-8 Burst measurement

- ① **POWER ON** and check for **CHECK** operation.
- ② Set **FUNCTION** to **FREQ. C**.
- ③ Connect the signal to be measured to **INPUT C**.
- ④ Set the input sensitivity according to the signal to be measured.
- ⑤ Check that the display fluctuates, then press the **BURST** switch.
- ⑥ Select a **GATE TIME** according to the required precision. The burst width must be longer than the **GATE TIME**.
- ⑦ Pressing the **MASK** switch enables delay start. Delay time can be set by **MASK TIME** control ⑧ to initiate a belated measurement.



3-3-5. Period Measurement (PERIOD B)

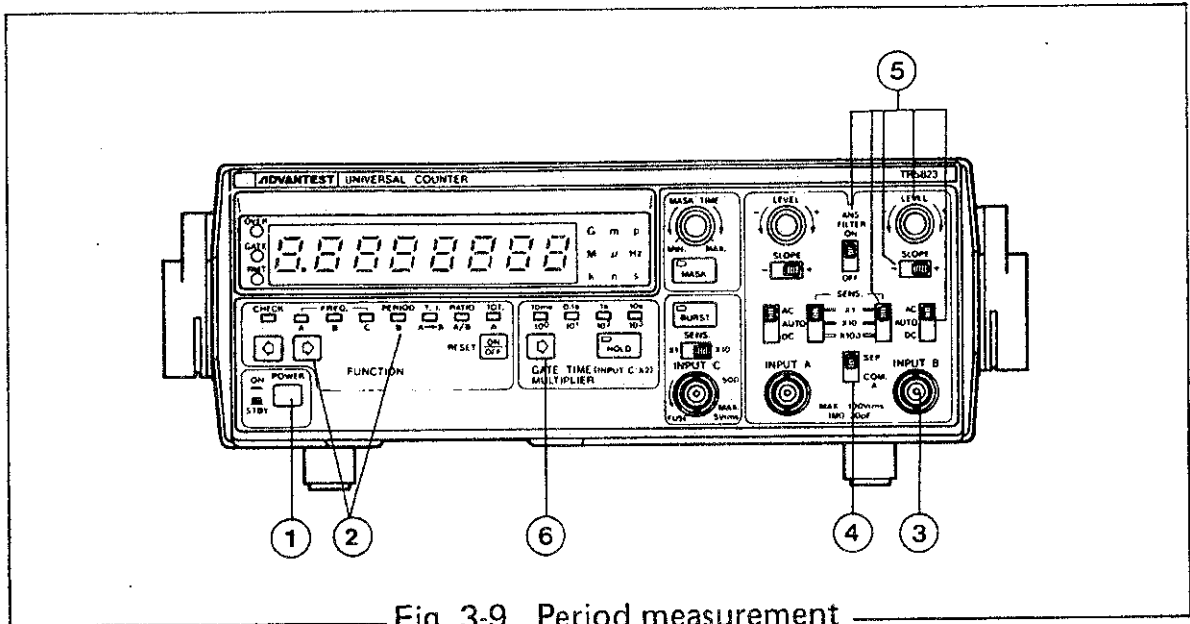

Fig. 3-9 Period measurement

- ① **POWER ON** and check for **CHECK** operation.
- ② Set **FUNCTION** to **PERIOD B**.
- ③ Connect the signal to be measured to **INPUT B**.
- ④ Set the **SEP./COM. A** switch to **SEP.**
- ⑤ Set each switch according to the signal to be measured.
- ⑥ Select a **MULTIPLIER** according to the required precision.

3-3-6. Time Interval Measurement (T.I. A → B)

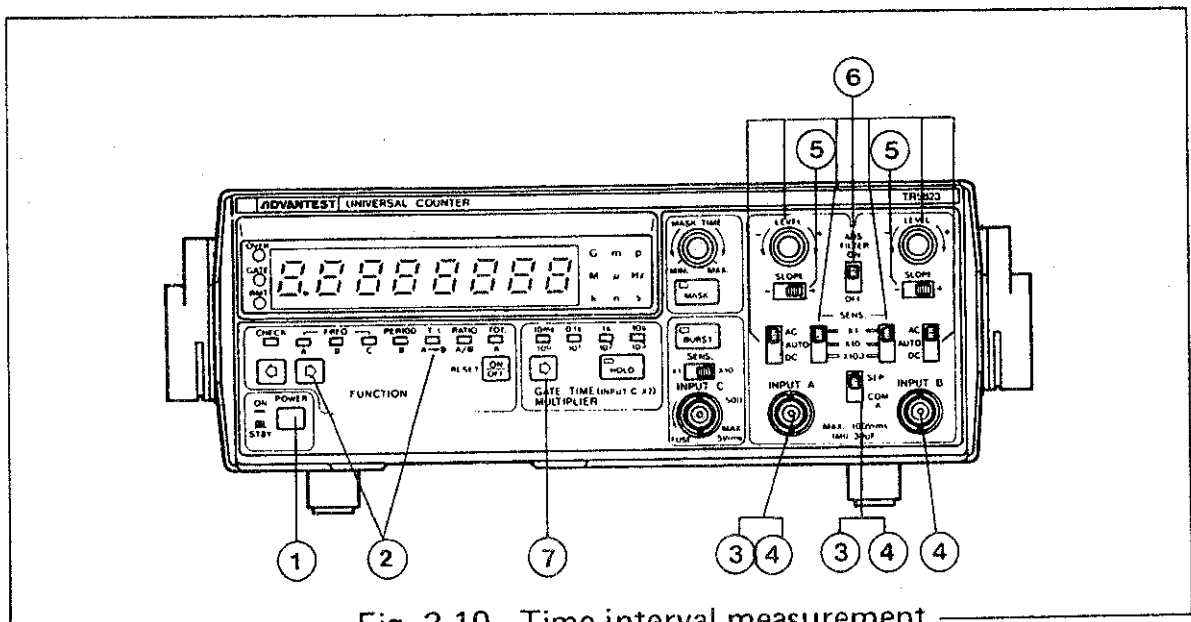

Fig. 3-10 Time interval measurement

- ① **POWER ON** and check for CHECK operation.
- ② Set **FUNCTION** to T.I. A → B.
- ③ For single-signal measurement, set the **SEP./COM. A** switch to **COM. A** with the signal of interest connected to **INPUT A**.
- ④ When two signals are to be measured, connect the start signal (the signal generated first) to **INPUT A** and the stop signal (the signal generated later) to **INPUT B**, then set the **SEP./COM. A** switch to **SEP.**
- ⑤ Set the **SLOPE** switch according to the start and stop points on the slope.
- ⑥ Set each switch to suit the signal to be measured.
- ⑦ Select a **MULTIPLIER** according to the required precision.

3-3-7. Frequency Ratio Measurement (RATIO A/B)

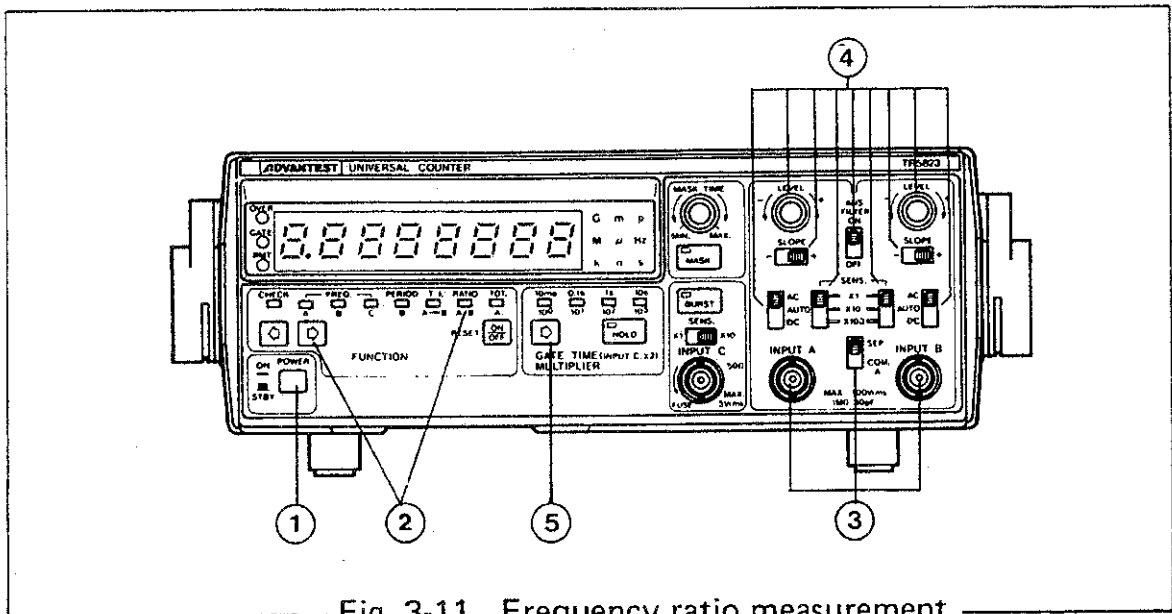

Fig. 3-11 Frequency ratio measurement

- ① **POWER ON** and check the CHECK operation.
- ② Set **FUNCTION** to **RATIO A/B**.
- ③ Set the **SEP./COM. A** switch to **SEP.**, then connect the signals to be measured to **INPUT A** and **INPUT B**.
- ④ Set each switch according to the signals to be measured.
- ⑤ Select a **MULTIPLIER** according to the required precision.

3-3-8. Totalize (TOT. A)

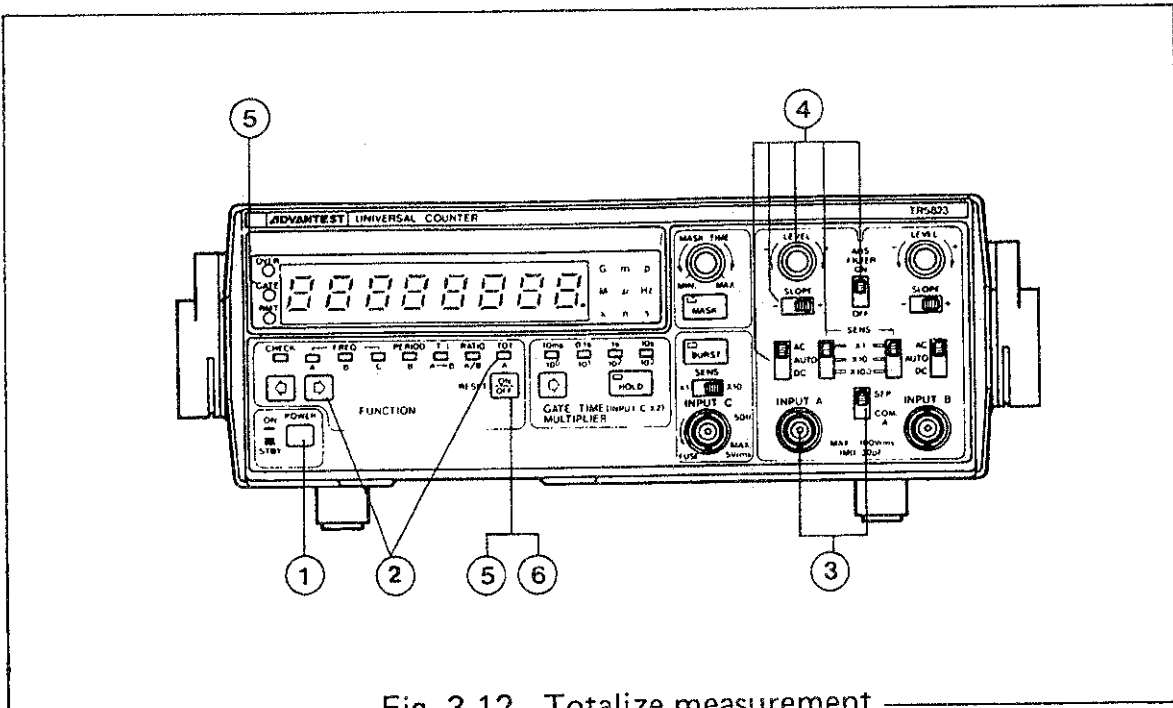
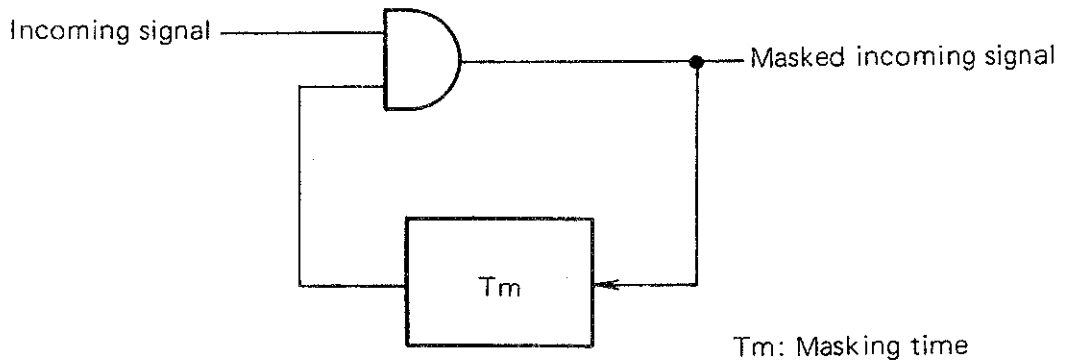

Fig. 3-12 Totalize measurement

- ① **POWER ON** and check for CHECK operation.
- ② Set **FUNCTION** to **TOT. A**.
- ③ Set the **SEP./COM. A** switch to **SEP.**, with the signal of interest connected to **INPUT A**.
- ④ Set each switch according to the signal to be measured.
- ⑤ Press the switch and release it, then the **GATE** lamp in the display section goes on and counting starts.
- ⑥ Press the switch again, then the counting stops, the **GATE** lamp goes out, and the final counted value is displayed.
- ⑦ When the **HOLD** lamp is not on (), the previous totalized value is reset; when the **HOLD** lamp is on (), the previous totalized value is added to the current totalization. If the counting result exceeds the display capacity (8 digits), the **OVER** lamp in the display section goes on.

3-3-9. Masking

A masking circuit triggered by the signal to be measured inhibits the signal to be measured, thus ignoring the signal of interest for the period of masking time after being triggered by the signal.



Consider measuring T_x of the signal shown below. When **MASK** is OFF, $T_{x'}$ is measured. Setting the masking time to T_m will enable the measurement of T_x .

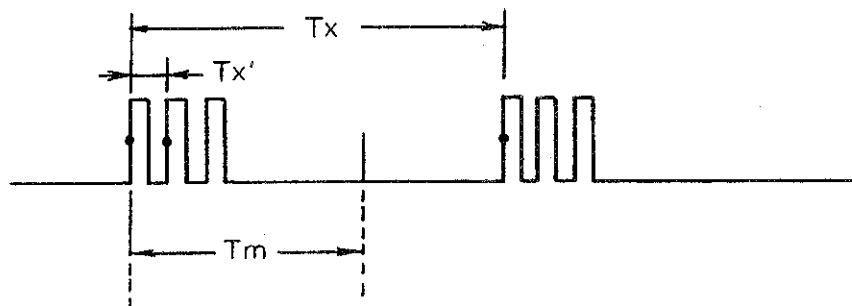

Masking can be utilized in the **FREQ. B, PERIOD B, T.I. A → B, RATIO A/B, and TOT. A** functions.

3-3-10. High-frequency Fuse Replacement

INPUT C connector of the **TR5823** is fuse protected. Use the following procedure to replace the fuse.

(1) Fuse rating

Part No.	Rating	Manufacturer
251.125	Axial lead 1/8A Subminiature picofuse	Littelfuse, Inc.

(2) External view of connector

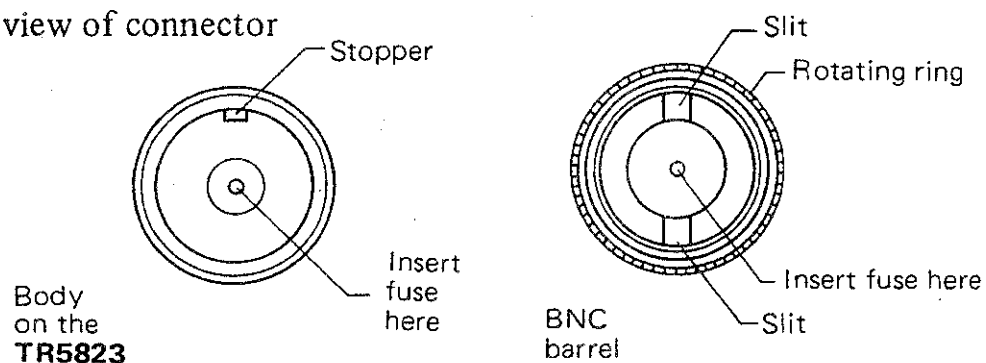

(3) How to cut off the fuse

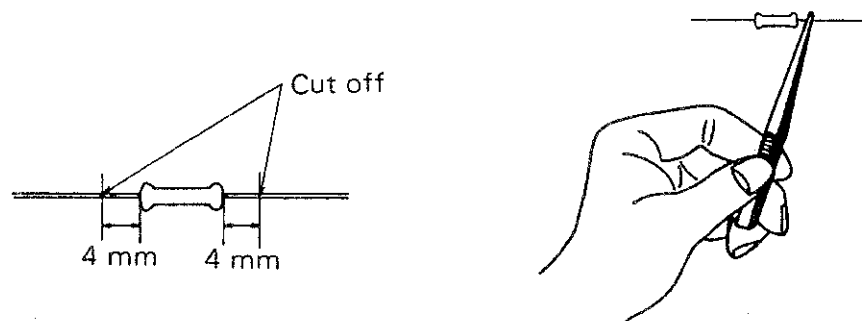

Use sharp pliers to cut the fuse. Avoid, by holding it with a pair of tweezers, exerting a stress on the fuse.

(4) Replacement procedures

- ① Remove the connector barrel by turning the outer ring counterclockwise.
- ② Remove the blown fuse.
- ③ Insert the fuse (which is cut out as described above) into the small hole in the center of the connector barrel. (Insertion is made easier by rotating the fuse or the connector.)
- ④ Guide the slit on the BNC barrel to the stopper on the **TR5823** connector body and insert the fuse into the central hole in the connector.
- ⑤ Gently turn the outer ring clockwise.
- ⑥ Tighten the ring. Care should be taken not to overtighten.

SECTION 4

GPIB INTERFACE

4-1. Introduction

Among the **TR5820** series, GPIB interface is standard on the **TR5822** and optional on the **TR5823**, enabling them to connect to a GPIB, IEEE Standard 488-1978. This section describes the GPIB specifications and functions. (GPIB: General Purpose Interface Bus)

4-2. General Outline of the GPIB

The GPIB is an interface system for simple cable (bus line) connections between measuring equipment and controller or peripheral devices.

The GPIB is much easier to use than conventional interface systems and includes a greater expansion capacity. And since it is compatible electrically, mechanically and functionally with other manufacturers' equipment, it is possible to construct a wide range of systems from relatively simple systems up to high-performance automatic measuring systems by using a single bus cable.

In GPIB systems, the "address" of individual component devices connected to the bus line should be first set. Each of these devices may have one or more of the controller, talker or listener roles. During system operation, only one "talker" can transmit data via the bus line, while several "listeners" can receive that data. The controller designates the "talker" and "listener" addresses and transfers data from the "talker" to the "listener", or the controller itself ("talker") may set measuring conditions for the "listener".

Eight bit-parallel byte-serial data lines are used for data transfer between different devices, bidirectional transmission being possible in asynchronous mode. Furthermore, in asynchronous systems, it is also possible to connect high-speed and low-speed devices together in any configuration.

The data (messages) transferred between devices includes measurement data, measuring conditions (program) and various different commands. ASCII code is employed.

In addition to the 8 data bus lines mentioned above, the GPIB also includes 3 handshake lines for control of asynchronous data transfer between devices, and 5 control lines for management of the data flow on the bus.

- The following signals are used on the handshake line.
 - DAV (Data Valid)** Signal indicating validity and availability of data.
 - NRFD (Not Ready For Data)** . Indicates that the device is not ready to receive data.
 - NDAC (Not Data Accepted)** . . Indicates that data is not accepted.
- And the following signals are used on the control line.
 - ATN (Attension)**. Signal used to specify whether the data line signal is an address or command, or some other data.
 - IFC (Interface Clear)** Signal for clearing the interface.
 - EOI (End or Identify)** Signal used upon completion of data transfer.
 - SRQ (Service Request)**. Signal used in making a request for controller service from any device.
 - REN (Remote Enable)**. Signal used in remote control of devices with remote control capacity.

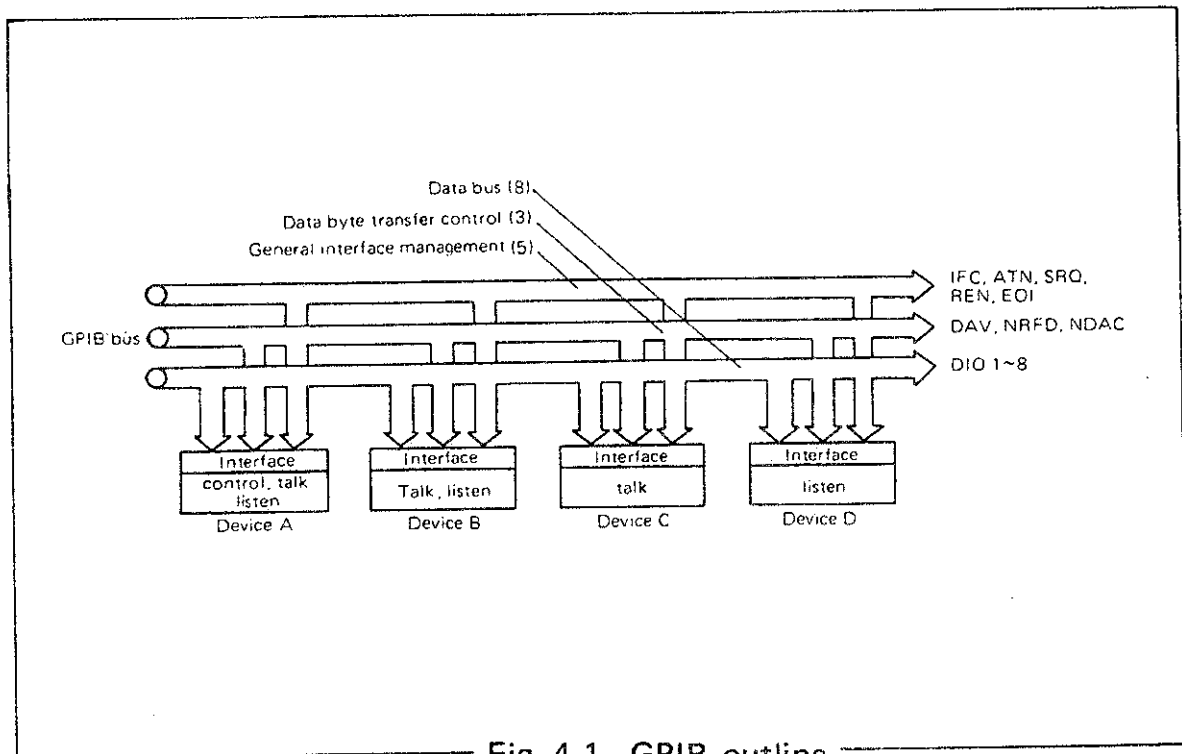

Fig. 4-1 GPIB outline

4-3. Specifications

4-3-1. GPIB Specifications

- Standard : IEEE Standard 488-1978
Codes used : ASCII
Logic level : Logic 0: High, +2.4 V or higher
 Logic 1: Low, +0.4 V or lower
Signal line terminal : The 16 bus lines are terminated as shown below.

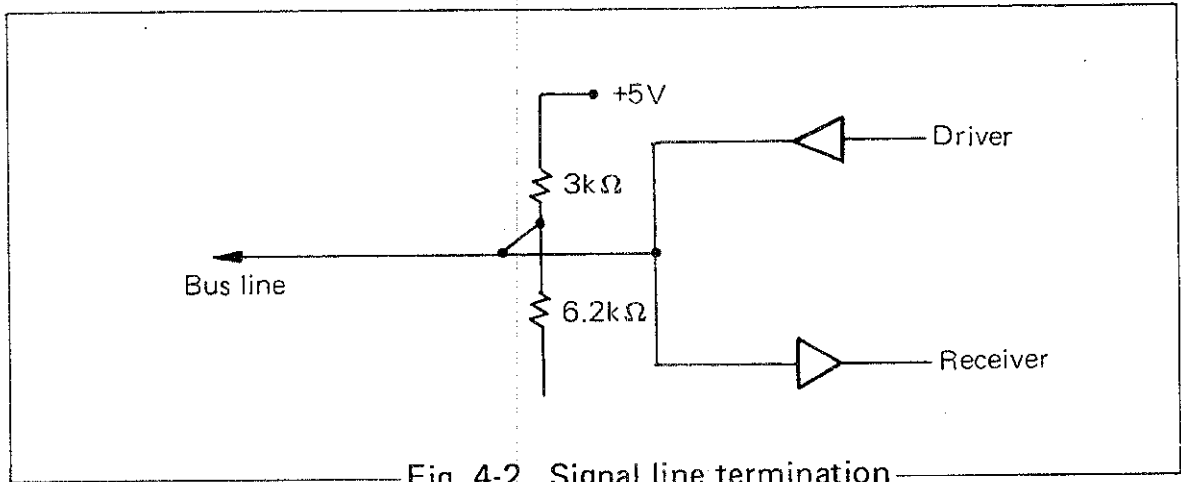

Fig. 4-2 Signal line termination

- Driver : Open collector type
 Low output voltage : +0.4 V or lower, 48 mA
 High output voltage : +2.4 V or higher, -5.2 mA
- Receiver : Low state : +0.6 V or lower
 High state : +2.0 V or higher
- Bus cable length : The total bus cable length must be (the number of devices connected to the bus) × 2 m or less, not exceeding 20 m.
- Address specifications : Any of 31 talk/listen addresses can be set by operating the address selector switch on the rear panel.
 TALK ONLY mode can also be specified.
- Connector : 24-pin GPIB connector
 57LE-20240-77COD3591
 (manufactured by D.D.K.)

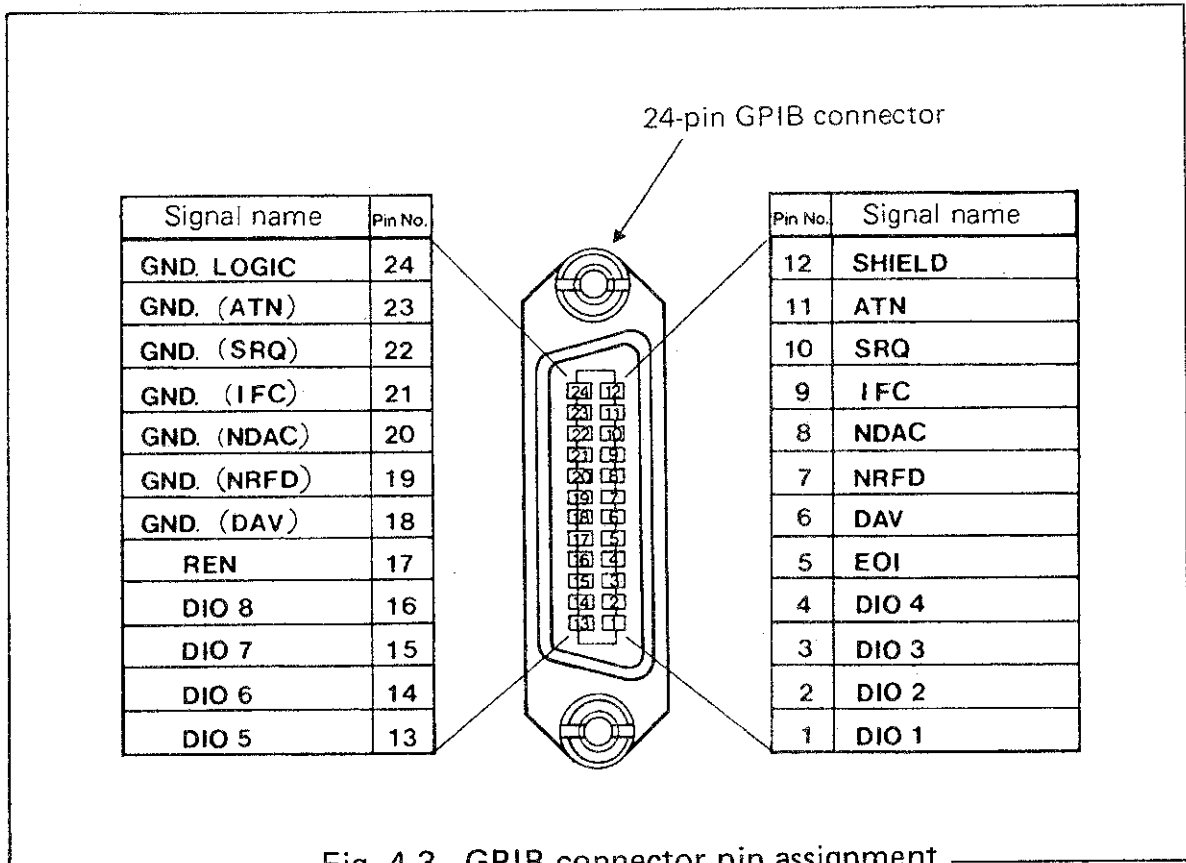

Fig. 4-3 GPIB connector pin assignment

4-3-2. Interface Functions

Table 4-1 Interface functions

Code	Function
SH1	Source handshake
AH1	Acceptor handshake
T5	Basic talker, Serial poll, Talk only mode, Unaddressed to talk if addressed to listen
L4	Basic listener, Unaddressed to listen if addressed to talk
SR1	Service request
RL1	Remote function
PP0	No parallel poll function
DC1	Device clear (SDC and DCL commands can be used.)
DT1	Device trigger (GET command can be used.)
C0	No controller function
E1	Open collector driver

4-4. Data Formats

4-4-1. Talker Format (Data Output Format)

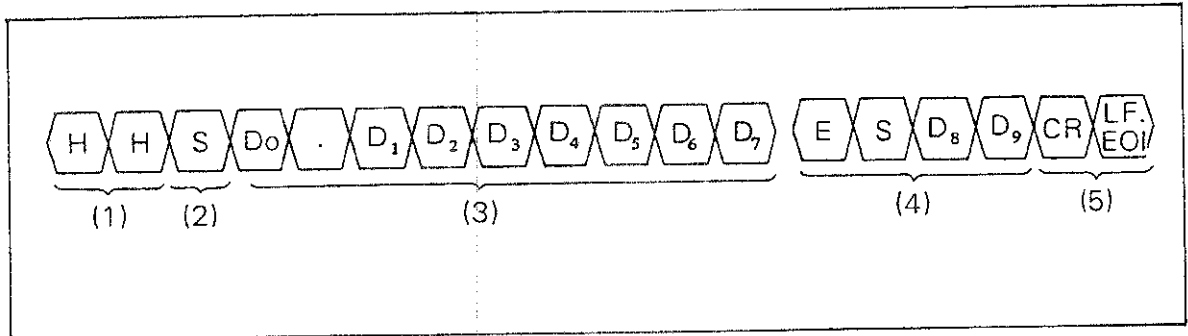

(1) Header

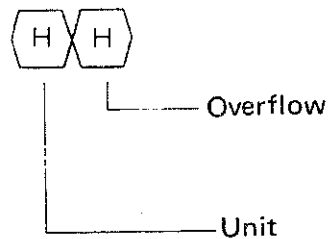

O : Overflow

␣ : No overflow.

F : Indicates that unit of output data is Hz.

This is output when the measurement function is any of the following:

CHECK
FREQ. A
FREQ. B
FREQ. C

S : Indicates that the unit of output data is s.

This is output when the measurement function is either PERIOD B or TIME INTERVAL.

␣ : Indicates that the output data has no unit.

This is output when the measurement function is either RATIO or TOTALIZE.

(2) Data sign

“␣” (space): for +

“-” : for -

(3) Data

Data (8 digits) + decimal point (1 digit)

The decimal point is fixed to the second position from the leftmost.

(4) Exponential sign and data

$$\left\{ \begin{array}{l} E + 15 \\ \quad \zeta \\ E + 00 \\ \quad \zeta \\ E - 12 \end{array} \right.$$

(5) Data delimiters

Ⓐ : CR, LF, EOI

Ⓑ : LF

Ⓒ : EOI (synchronous with the last data)

Three types of delimiters (a to c) can be selected by programs.

* When **HEADER** of the address switch on the rear panel is set to **OFF**, two space codes are output in the header position.

4-4-2. Listener Format (Remote Code)

(1) Function setting code

Code	Function
F 0	CHECK
F 1	FREQ. A
F 2	FREQ. B
F 3(*)	FREQ. C
F 4	PERIOD
F 5	TIME INTERVAL
F 6	RATIO
F 7	TOTALIZE (OFF)
F 8	TOTALIZE (ON)

* F3, though settable, will not activate the operation in the TR5822, which is not provided with the FREQ. C.

(2) Gate time (multiplier) setting codes

Code	Gate time (multiplier)
G 0	10ms (X 1)
G 1	100ms (X 10)
G 2	1 s (X 100)
G 3	10s (X 1000)

(3) Delimiter setting codes (Output delimiters)

Code	Delimiter
DL 0	CR/LF, EOI
DL 1	LF
DL 2	EOI

(4) SRQ setting codes

Code	Function
S 0	Outputs SRQ.
S 1	Does not output SRQ.

(5) HOLD setting codes

Code	Function
S2	HOLD released
S3	HOLD

(6) Other codes

Code	Function
E	Trigger (same as GET)
C	Clear (same as DCL, SDC)

- * GET (Group Execute Trigger) Measurement start
- SDC (Selected Device Clear) Initialization of equipment
- DCL (Device Clear)

(7) Code recognition

Invalid characters in remote codes are ignored.

Examples:

- F9 – 9 is ignored and the next data is read (F is valid)
F90 – Recognized as F0.
- G510 – Recognized as G1.
With input of 5, G5 is not valid; 5 is ignored and the next 1 is read.
Since G1 is valid, G1 is set as the remote code.
- FG32 – Recognized as G3.
FA32 – Recognized as F3.
If a valid letter (F) is followed by another valid letter (G) before the formation of the valid code (F3), the last entered letter (G) is made effective and the previous one (F) is ignored.

4-4-3. Initial Values

The following initial settings are made at **POWER ON** of this unit or when universal command DCL, address specification command SDC, or program code C is received from the controller:

Function : CHECK
Gate time : 10 ms
Delimiter : CR, LF, EOI
Service request : S1 (not to output SRQ)
HOLD : S2 (not to hold)

4-4-4. Input Delimiter

Input delimiter is LF or EOI. When a controller that outputs CR or EOI is used, add **P** at the end of the program code.

Example: F1G1S3EP

4-4-5. Service Request

Service request is made when the data is output on completion of measurement.

Status byte:

When a service request is issued, this unit sends the status byte shown below to the controller in response to the serial polling from the controller.

(MSB)	D8	D7	D6	D5	D4	D3	D2	D1
	0	1	0	0	0	0	0	1

○ D1 = 1:
Measurement completion bit

Note: In the S1 mode (SRQ OFF), D7 of this unit is not set to 1.

4-5. GPIB Operating Procedures

4-5-1. Connection to Component Devices

Since a GPIB system includes a number of component devices, pay special attention to the following points during preparation of the overall system.

- (1) Before connecting up the component devices (as described in the respective instruction manuals for the **TR5820** Series, controller and peripheral devices), first check the preparation status (readiness) and operation of each device.
- (2) The connecting cable for the measuring equipment and the bus cable for controller connections should be no longer than necessary. The length of the bus cable in particular must not exceed the prescribed length. The total bus cable length is (number of devices connected to the bus) \times 2 m max., and not in excess of 20 m. The following standard bus cables are available from ADVANTEST.

Table 4-2 Standard bus cables (To be purchased separately)

Length	Stock No.
0.5 m	408JE-1P5
1 m	408JE-101
2 m	408JE-102
4 m	408JE-104

- (3) When using bus cable connections, do not use 3 or more connectors in combination. Also check that the connector securing screws are properly tightened.
Bus cable connectors are "piggyback" types with both plug and socket sides, thereby enabling connectors to be stacked.
- (4) Do not switch on the power for each of the component devices until power requirements, grounding condition and, if necessary, the setting conditions have been properly checked.
The power for all devices connected to the bus must be switched **ON**. If the power for even a single device is left off, the entire system may fail to properly operate.
- (5) Be sure to disconnect power from the instrument when connecting or removing the bus cable.

4-5-2. Panel Description

- (1) When the counter is set to Remote, the **RMT** lamp to the left of the front panel readout goes on.
 - (2) While the **RMT** lamp is on, the following switches are disabled:
 - FUNCTION** selector switch
 - GATE TIME** selector switch
 - RESET** switch
 - HOLD** switch
 - MASK** switch
 - BURST** switchAll switches on the **TR1644** Calculation Unit (accessory)
- * The sliding switches and controls at the input section remain valid in the Remote State.
- (3) The Remote settings (such as function) are retained when the state of the counter is changed from Remote to Local by the controller unless the **POWER** switch of the counter is set to **OFF**. When the counter is returned to the Remote state after altering the state to Local and changing the settings by operating the panel switches, the previous Remote settings are retained. (It appears that the settings such as function are also changed by simply changing the state from Local to Remote.) (See the positions indicated by the arrows in Figure 4-4.)

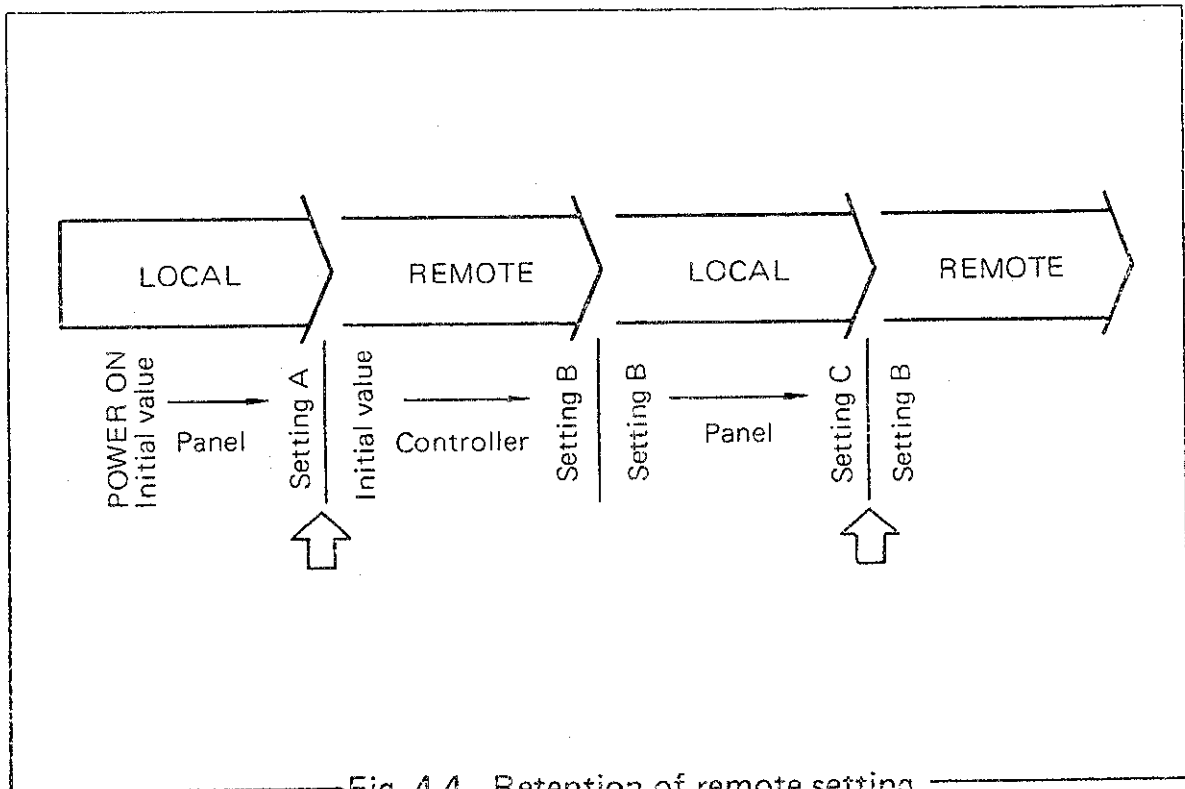

Fig. 4-4 Retention of remote setting

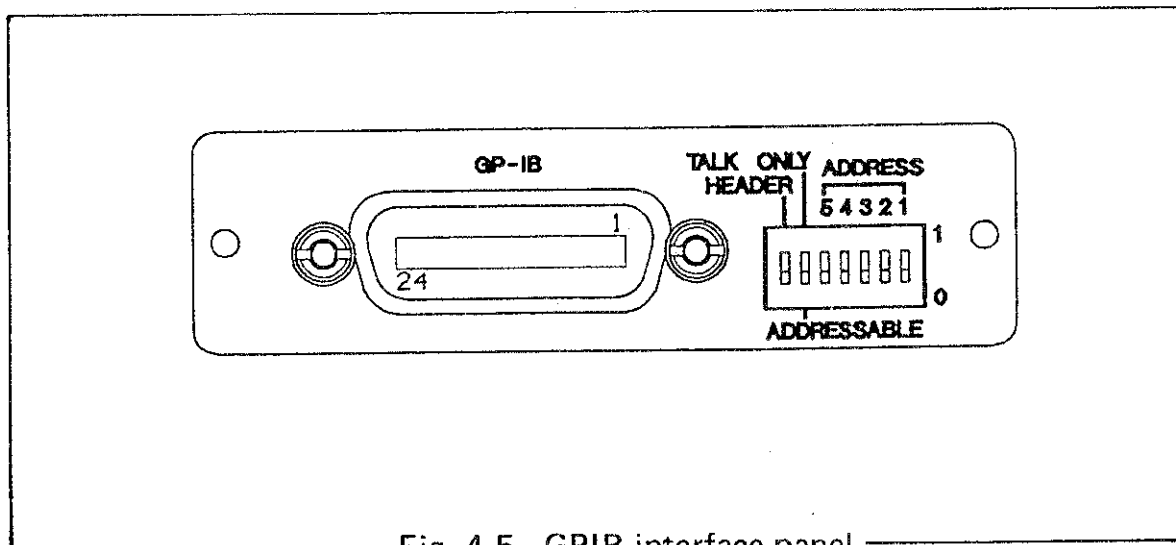

Fig. 4-5 GPIB interface panel

- ① **ADDRESS** switch
 DIP switch for setting the counter bus address (talker or listener address). Bits 1 to 5 set the counter address code. If bit 6 is set to **ADDRESSABLE**, the counter can be addressed by the controller, while if set to **TALK ONLY**, the counter will act as a “talker” irrespective of the **ADDRESS** 1 to 5 settings. If bit 7 is set to “1”, the header is transmitted during data transmission, but if set to “0”, the header section becomes a space code.
- ② **GPIB** connector
 The 24-pin connector for bus cable connections. Since this is a “piggy-back” type connector, standard bus cables can be used joined to each other. However, not more than 3 connectors should be stacked together in this fashion.

4-5-3. Address Setting

The universal counter talk address and listen address within the GPIB system are set by the rear panel **ADDRESS** switch.

This switch is a 7-bit (7-position) DIP switch where any of 31 different addresses may be set by bits 1 to 5 (positions 1 to 5).

The 00100 setting shown in Fig. 4-5, for example, corresponds to decimal “4”. When expressed in ASCII code, this example corresponds to “D” for talker, and “\$” for listener (see Table 4-3).

When bit 6 is set to **ADDRESSABLE**, the counter will respond only when the address designated by the controller matches the address set by the counter (**ADDRESS** 1 to 5). When set to **TALK ONLY**, the counter becomes a talker irrespective of the address set by **ADDRESS**.

When bit 7 is set to "1", the 2-character header is transmitted during the data transmission. When set to "0", however, the 2 characters become space codes.

Table 4-3 Address code table

ASCII code character		ADDRESS switches					Decimal code
LISTEN	TALK	A5	A4	A3	A2	A1	
SP	@	0	0	0	0	0	00
!	A	0	0	0	0	1	01
"	B	0	0	0	1	0	02
#	C	0	0	0	1	1	03
\$	D	0	0	1	0	0	04
%	E	0	0	1	0	1	05
&	F	0	0	1	1	0	06
'	G	0	0	1	1	1	07
(H	0	1	0	0	0	08
)	I	0	1	0	0	1	09
*	J	0	1	0	1	0	10
+	K	0	1	0	1	1	11
,	L	0	1	1	0	0	12
-	M	0	1	1	0	1	13
°	N	0	1	1	1	0	14
/	O	0	1	1	1	1	15
0	P	1	0	0	0	0	16
1	Q	1	0	0	0	1	17
2	R	1	0	0	1	0	18
3	S	1	0	0	1	1	19
4	T	1	0	1	0	0	20
5	U	1	0	1	0	1	21
6	V	1	0	1	1	0	22
7	W	1	0	1	1	1	23
8	X	1	1	0	0	0	24
9	Y	1	1	0	0	1	25
:	Z	1	1	0	1	0	26
:	[1	1	0	1	1	27
<	\	1	1	1	0	0	28
=]	1	1	1	0	1	29
>	~	1	1	1	1	0	30

4-5-4. General Precautions during Operation

- (1) To use the counter in only mode, the rear panel **ADDRESS** switch must be set to the **TALK ONLY** position, and the address mode of the other devices connected to the bus line should also be set to only mode. Note, however, that during only mode the controller should not be used. If the controller is operated during only mode, the controller command will be disregarded, and the counter may fail to operate properly.
- (2) Power failure during operation
If there is a power failure (including momentary power failures) during operation of the GPIB system (including the universal counter), normal operation cannot be guaranteed after the power is restored. Normally, the complete system is initialized again. Power failure processing for the other devices included in the system must also be considered.
- (3) Controller interrupt during data transfer between devices
In the GPIB system, data transfer between devices apart from the controller is also possible. If an interrupt is generated in order to add another listener or to switch the controller to serial polling mode during data transfer (handshake operation) between devices, the data transfer is suspended, and priority given to the controller interrupt operation. Upon completion of the interrupt process, the previous data transfer operation is resumed.
Usually, the system is to be programmed so that the controller will recognize the data transfer state.

4-6. Programming Notes

4-6-1. Simplified Operational Flow Chart (Data Sending)

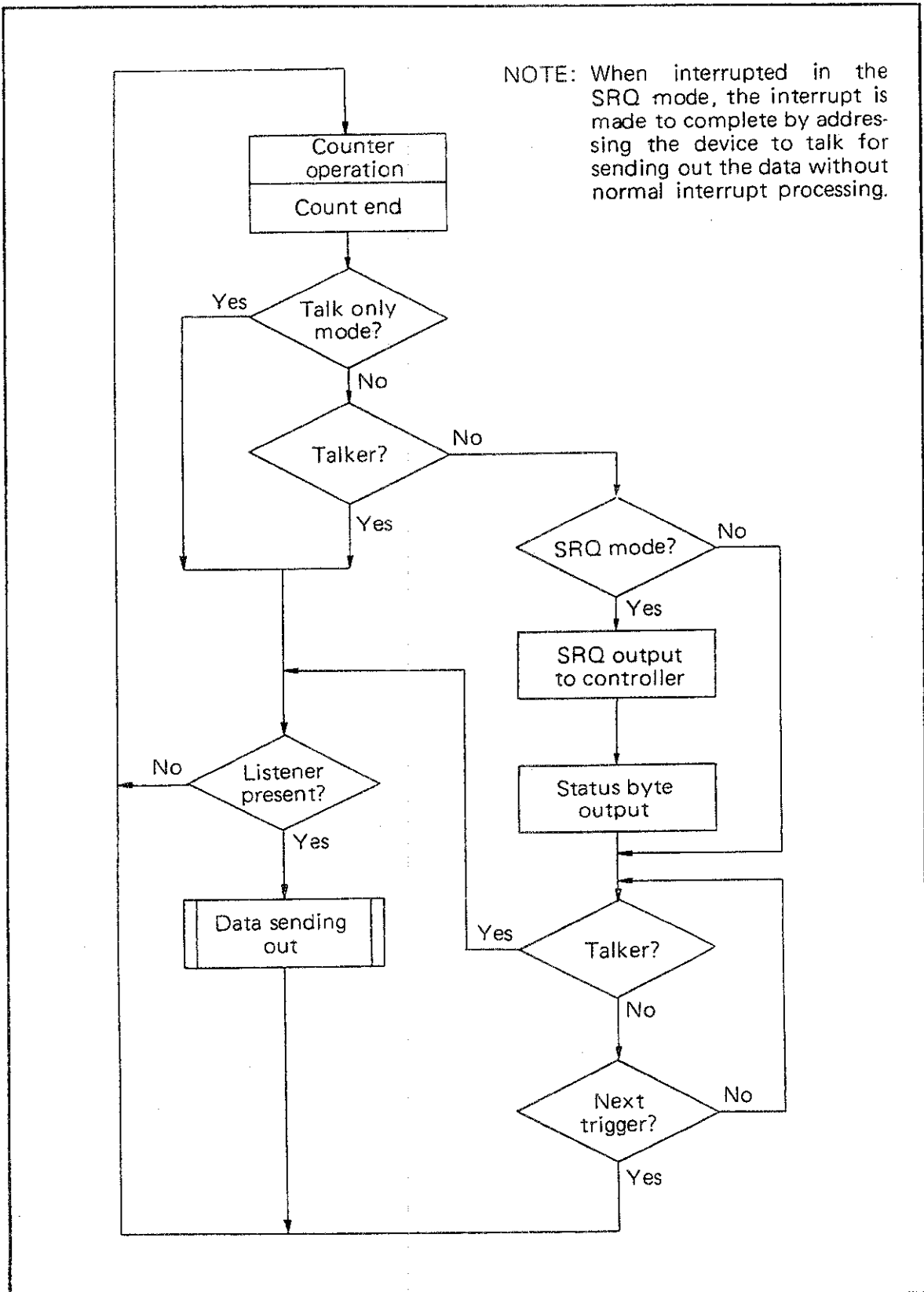

4-6-2. Service Request Operation

The following operation is made when a service is requested on completing the measurement cycle. Keep this in mind at program preparation.

(1) With serial polling

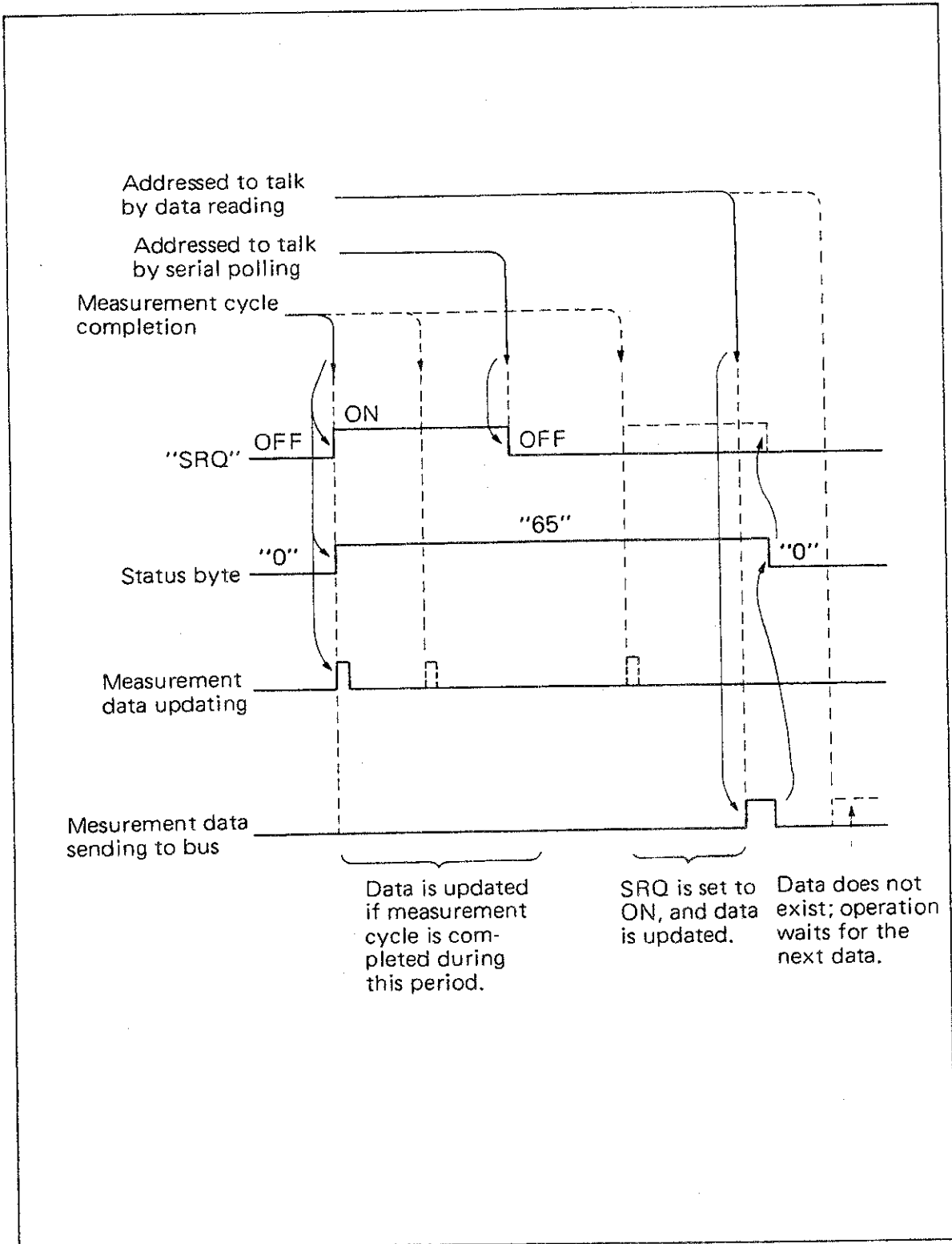

(2) When serial polling is not used

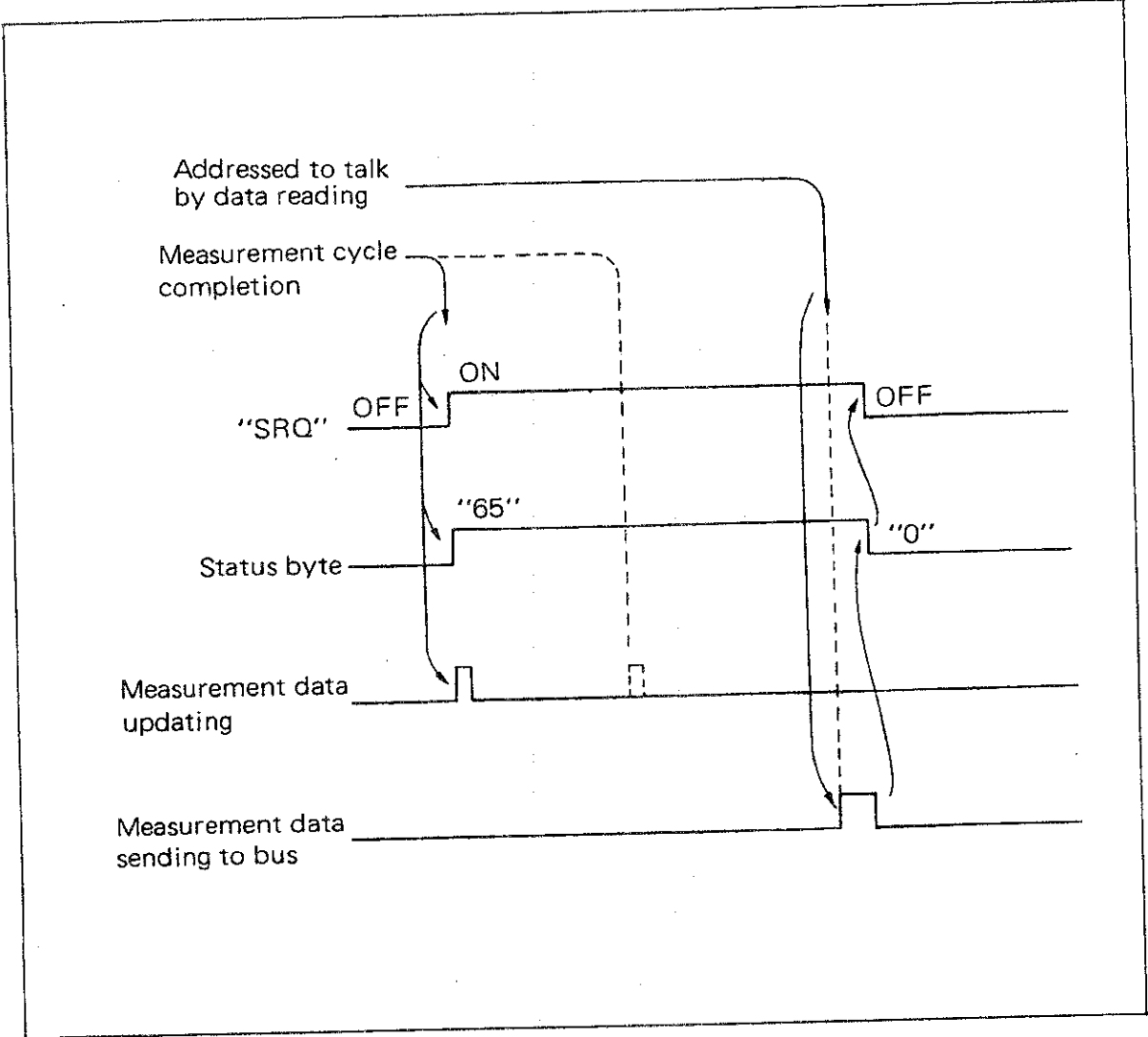

4-6-3. Data Sending Timing

(1) When measurement is started by program

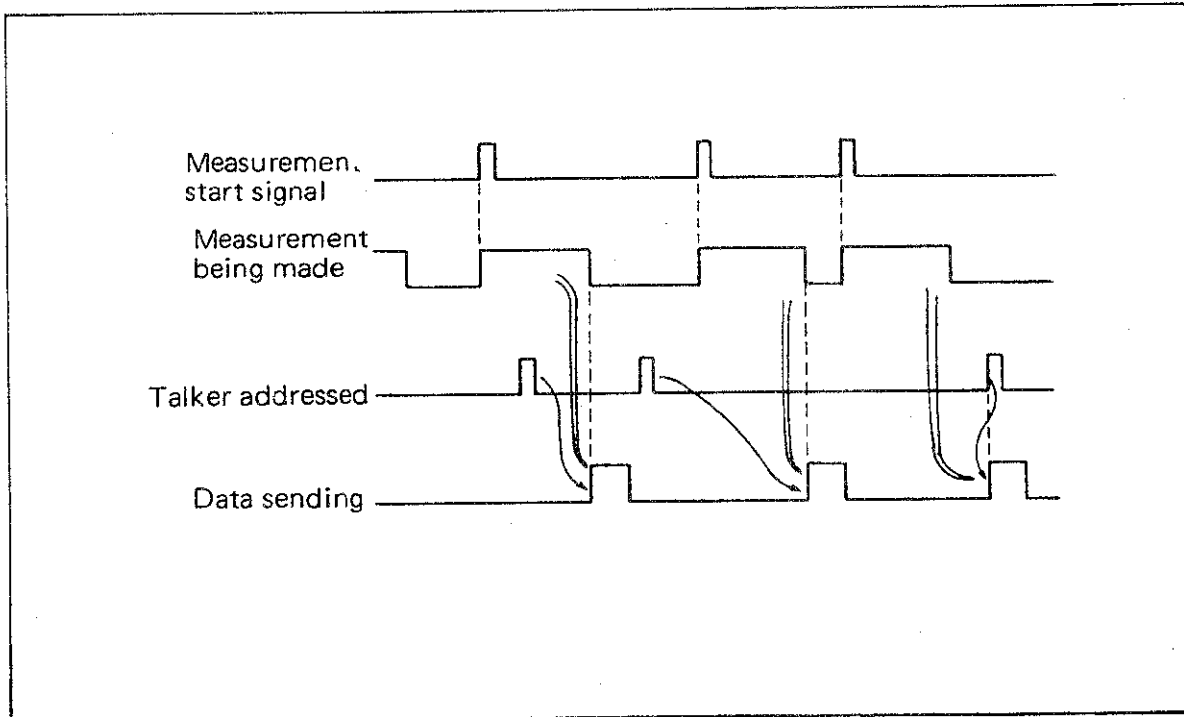

(2) When measurement is started manually or by free-run

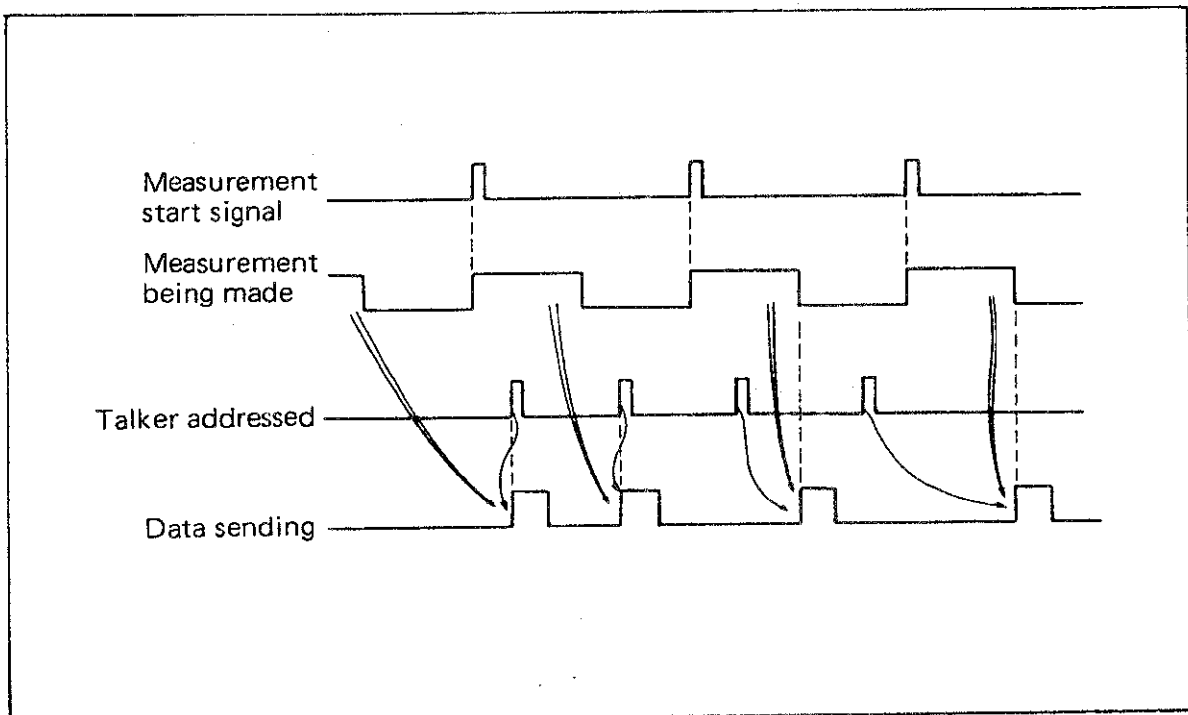

4-6-4. Programming Examples

Program examples of the same operation using two different controllers are shown here. Since these programs cover all measurement function operations, they can be used as test programs.

- (1) After specifying the **INPUT A**, gate times of less than 0.1 s, and a holding state, measurement data is captured with a trigger.

- ① Example for PC9801 series (using N88BASIC for MS-DOS)

- Program

```
1000 '
1010 ISET IFC
1020 ISET REN
1030 CNT=8
1040 PRINT @CNT;"C"
1050 PRINT @CNT;"F1, G1, S3"
1060 PRINT @CNT;"E"
1070 INPUT @CNT;A$
1080 PRINT A$
1090 GOTO 1060
1100 END
```

- Explanation

1010	Clears the setting of an interface.
1020	Sets Remote Enable.
1030	Assign the address of this equipment to a variable.
1040	Clears the setting of this equipment.
1050	Specifies the INPUT A , gate times of less than 0.1 s, and a holding state in this equipment.
1060	Triggers measurement (A command of starting measurement)
1070	Reads measurement data.
1080	Displays the measurement data on CRT.
1090	Goes back to a line 1060.
1100	Completes the program.

- Data

F 1.2345000E+06
F 1.2345000E+06
F 1.2345000E+06
F 1.2345000E+06

② Example for HP-200 series

• Program

```
1000  !
1010  Cnt=708
1020  CLEAR Cnt
1030  OUTPUT Cnt;"F1, G1, S3"
1040  TRIGGER Cnt
1050  ENTER Cnt:A$
1060  PRINT A$
1070  GOTO 1040
1080  END
```

• Explanation

1010	Assign the address of this equipment to a variable.
1020	Clears the setting of this equipment.
1030	Specifies the INPUT A , gate times of less than 0.1 s, and a holding state in this equipment.
1040	Triggers measurement (A command of starting measurement)
1050	Reads measurement data.
1060	Displays the measurement data on CRT.
1070	Goes back to a line 1040
1080	Completes the program.

• Data

```
F 1.2345000E+06
F 1.2345000E+06
F 1.2345000E+06
F 1.2345000E+06
```

- (2) The controller triggers measurement under a SQ mode as needs come up. The controller can execute other programs until the measurement ends. After finishing the measurement, the controller accepts a service request from the equipment, read data, and then go back the previous execution again. This example assumes that only an equipment sends a service request.

① Example for PC9801 series
(using N88BASIC that is not for MS-DOS)

• Program

(1/2)

```
1000 '  
1010 DFF SEG=&H60  
1020 A%=PEEK(&H9F3)  
1030 A%=A% AND &HBF  
1040 POKE &H9F3, A%  
1050 ISET IFC  
1060 ISET REN  
1070 CMD DELIM=0  
1080 CNT=8  
1090 ON SRQ GOSUB *SRQRoutine  
1100 PRINT @CNT;"C"  
1110 PRINT @CNT;"F1, G2, S0"  
1120 '  
1130 '***** MAIN ROUTINE *****  
1140 SRQ ON  
1150 FOR I=1 TO 1000 :NEXT I  
1160 PRINT @CNT;"E"  
1170 FLAG=0  
1180 IF FLAG=1 THEN 1160  
1190 GOTO 1180  
1200 END
```

```

1210 '
1220 '***** SRQ ROUTINE *****
1230 *SRQRoutine
1240     POLL 8, S
1250     IF S<>65 THEN 1300
1260     INPUT @CNT:A$
1270     PRINT "STATUS="+STR$(S)
1280     PRINT "FREQ="+A$+" Hz"
1290     FLAG=1
1300     SRQ ON
1310     RETURN

```

- Explanation

1010	Clears SRQ of GP-IB for PC9801.
5	Note: In N88BASIC for MS-DOS, specify "1010 :
1040	DEF SEG = SEGPTR(7).
1050	Clears the setting of an interface.
1060	Sets Remote Enable.
1070	Sets a delimiter to CR + LF.
1080	Assign the address of this equipment to a variable.
1090	Specify the first address for the SRQ routine.
1100	Specifies the INPUT A, gate times of less than 0.1 s, and a holding state in this equipment.
1140	Permission to receive SRQ.
1150	Specifies a wait time.
1160	Triggers measurement (A command of starting measurement)

1170	Clears a flag to terminate an interrupt-service routine.
1180	A loop to service an interrupt and to wait for an interrupt.
1190	
1200	Completes the program.
1240	Serial pole
1250	Goes to a line 1300 if an service request to output data is not sent.
1260	Read measurement data
1270	Displays a status byte on CRT.
1280	Displays the measurement data on CRT.
1290	Sets a flag to terminate an interrupt-service routine.
1300	Permission to receive SRQ.
1310	Goes back to the main routine.

- Data

```

STATUS= 65
FREQ=1. 2345000 + 06 Hz
STATUS= 65
FREQ=1. 2345000 + 06 Hz
STATUS= 65
FREQ=1. 2345000 + 06 Hz

```

SECTION 5 PRINCIPLES OF OPERATIONS

5-1. Introduction

This counter consists of a central microprocessor, two LSIs, a display IC, and an input circuit. The central microprocessor controls the two LSIs for measurement, processes the obtained data, and routes the processed data to the display IC or the external interface circuit. It also controls the panel switches and changes the measurement function according to the information from the panel. Thus, the instrument is operated completely under control of the microprocessor. This counter also has a self-diagnostics function by means of the microprocessor itself. Figure 5-1 shows the block diagram.

5-2. Operation of Each Block

5-2-1. Input Circuit

The input circuit shapes any signal to be measured into a waveform so the subsequent logic circuits can operate correctly. **AC-AUTO-DC**, **SENS.**, **FILTER**, **LEVEL**, **SEP./COM. A**, **SLOPE** are provided for this purpose.

(1) AC-AUTO-DC

When the waveform at point A in Figure 5-1 is as shown below, the waveform is shaped as on the right side of the figure according to **AC-AUTO-DC** selection. **AC** rejects the DC components, **AUTO** suppresses the DC component and automatically sets the trigger point at the 50% level of the amplitude, and **DC** sends the input waveform as it is to the Schmitt trigger circuit.

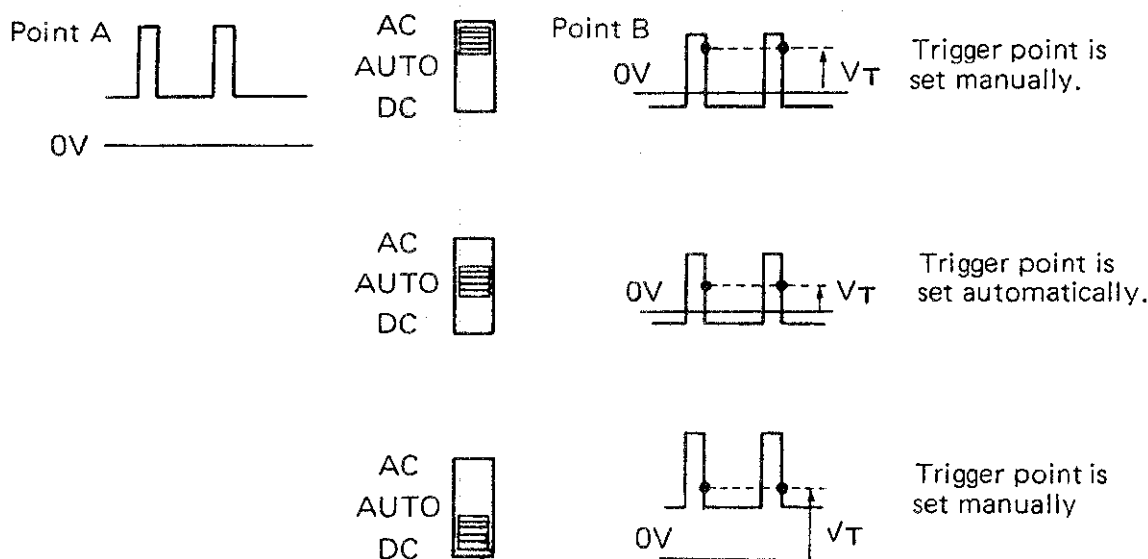

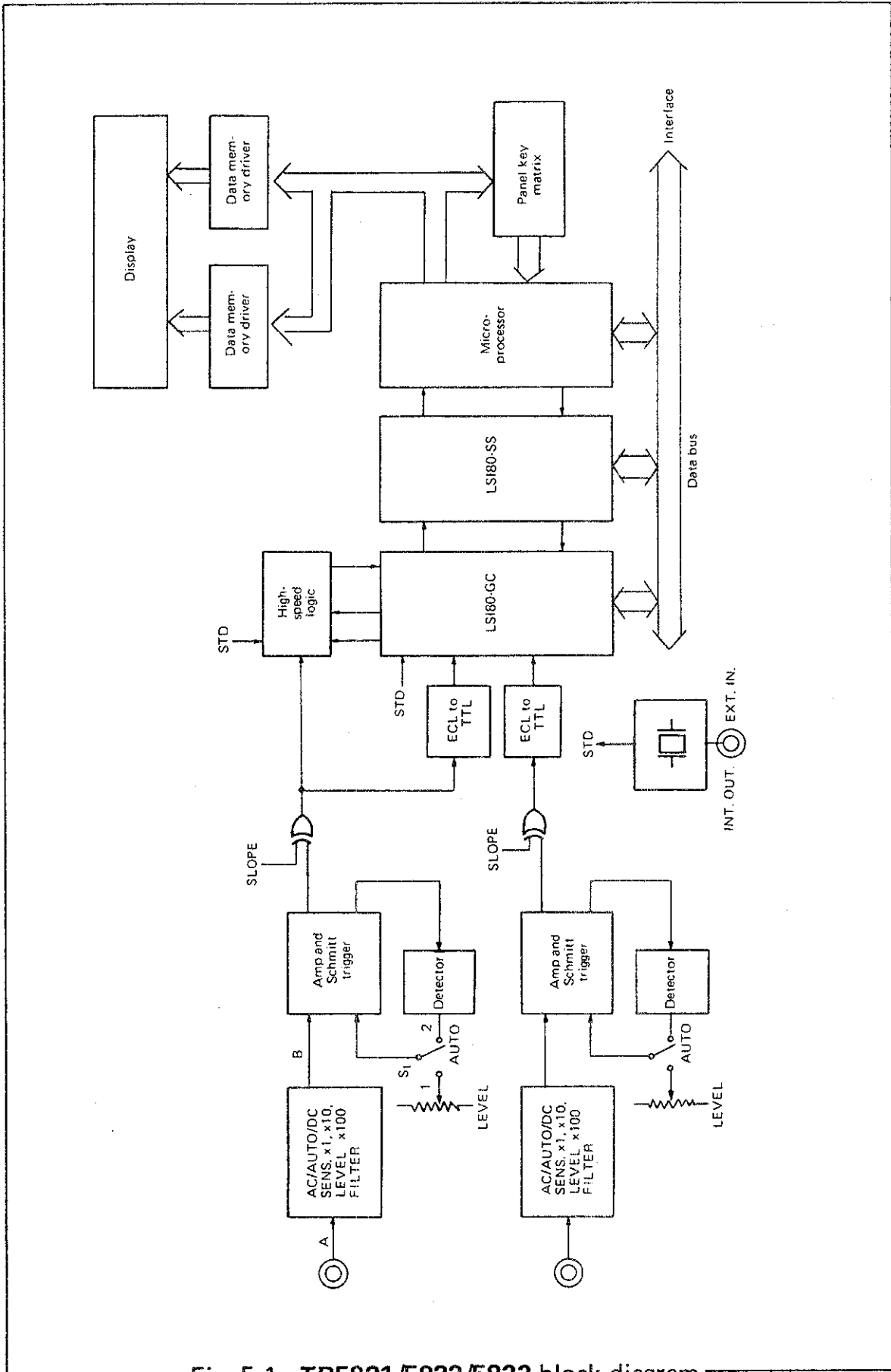
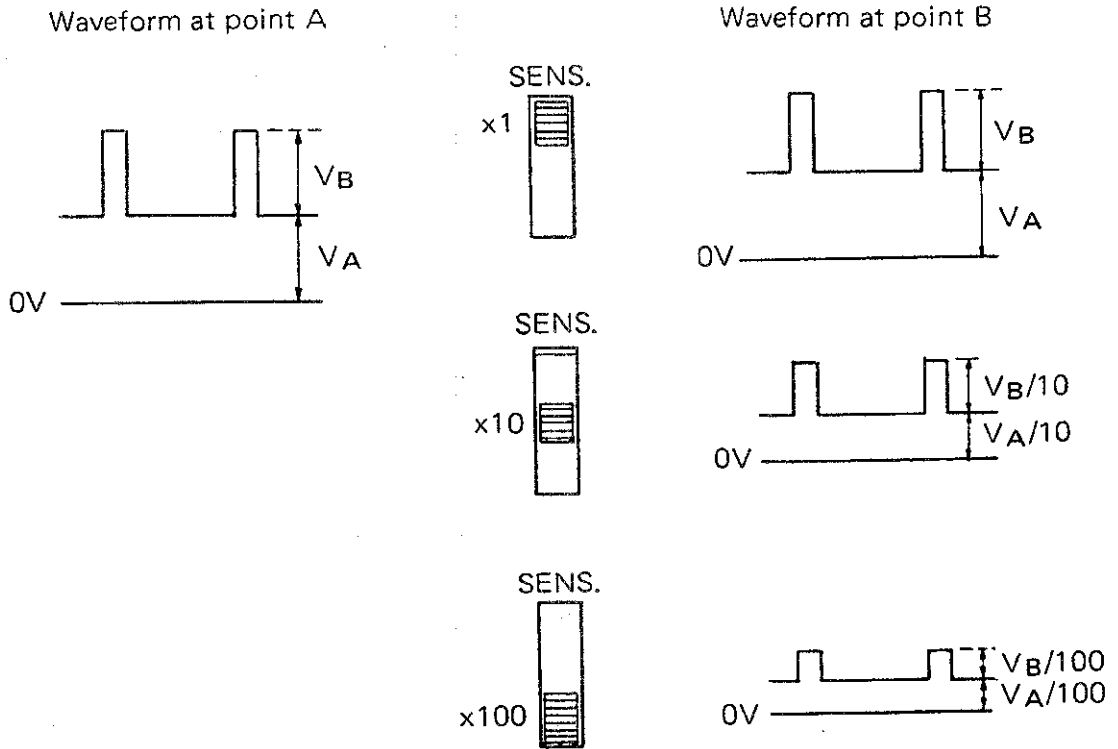

Fig. 5-1 TR5821/5822/5823 block diagram

(2) **SENS.**

Attenuator for adjusting the amplitude of the waveform to be sent to the Schmitt trigger circuit between the sensitivity voltage and the maximum input voltage.



If appropriate **SENS.** is not selected, counting may fail or the trigger point may deviate when the input exceeds the maximum input voltage. The attenuator is also effective for noise rejection. (Frequency measurement FREQ. A, C)

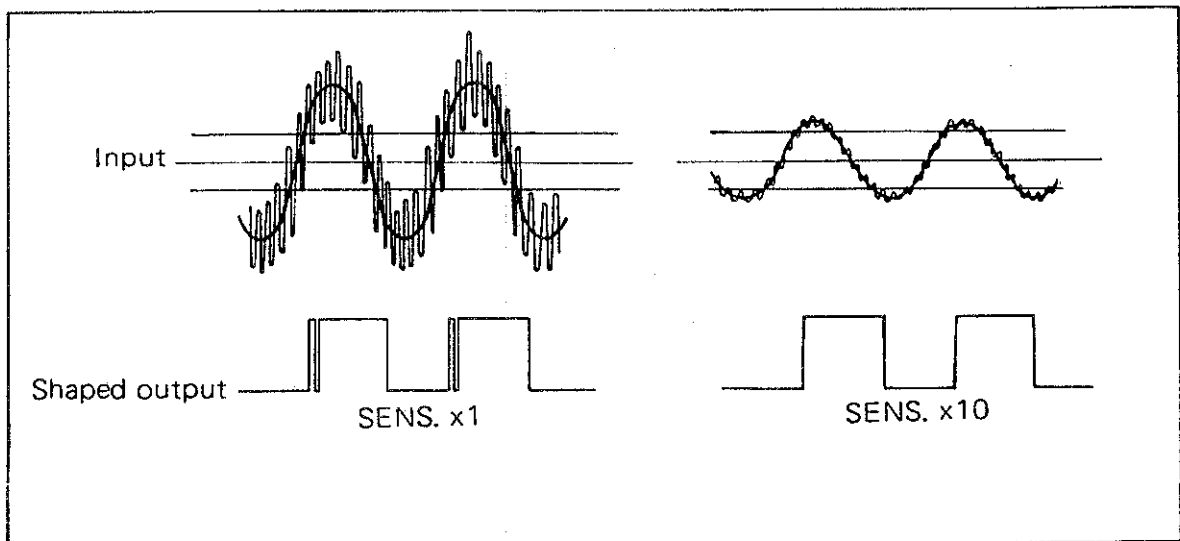

(3) FILTER

Generally, a low-pass filter is used for counter input. The cutoff frequency is about 100 kHz for the TR5821/22/23. TR5823 INPUT C has the ANS (Automatic Noise Suppressor) capability, and a filter is changed in compliance with the signal to be measured.

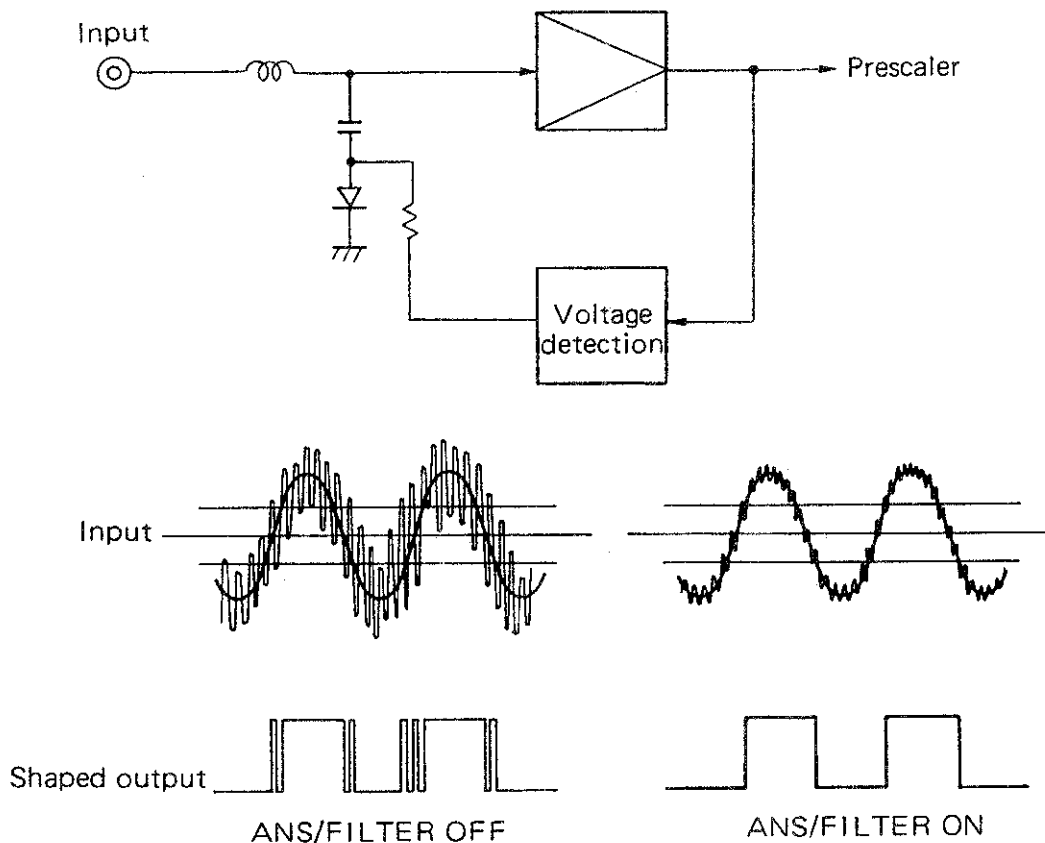

(4) LEVEL

The trigger level changes within a range of about +1 V to -1 V, that is, the trigger point can be set in the input voltage range of +1 V to -1 V. For **SENS.** x10 and x100, the input voltage range appears to vary between +10 to -10 V and +100 to -100 V respectively.

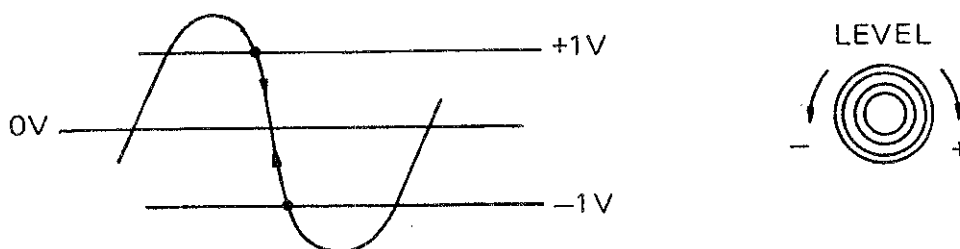

(5) SEP./COM. A

The counter has an input connector corresponding to each input channel. In measuring the time interval of a single signal, the same signal is input to both input connectors. If **SEP./COM. A** is set to **COM. A**, the signal at **INPUT A** connector is supplied to channels A and B; in **COM. A**, how-

ever, the input impedance will be about 500 k Ω and the shunt capacitance about 60 pF. The TR5821/5822/5823 have two frequency modes, **FREQ. A** and **FREQ. B**. **FREQ. A** gives higher precision for frequencies above 1 MHz, and **FREQ. B** gives higher precision for frequencies below 1 MHz. High-precision measurement over a wide range of frequencies is enabled by switching between **FREQ. A** and **FREQ. B** at setting **COM. A**.

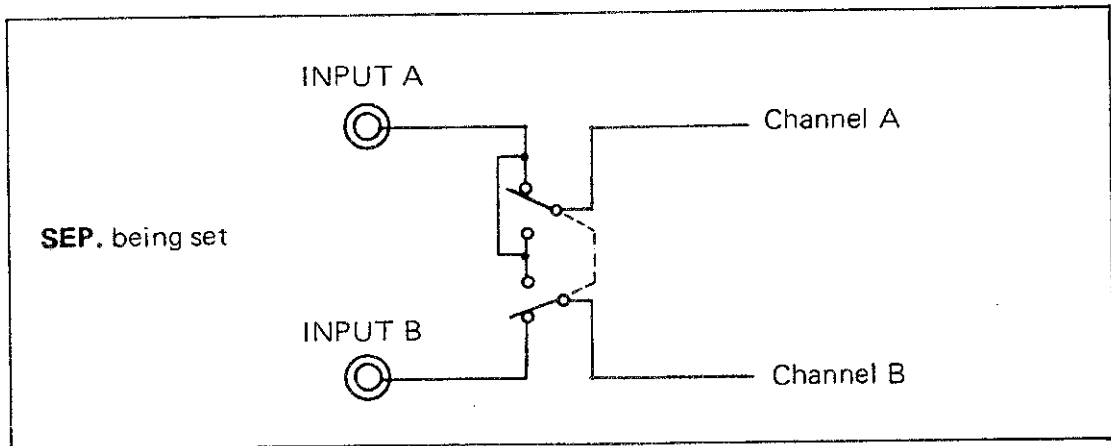

As shown above, this switching is made immediately after the input connector; therefore, **AC-AUTO-DC**, **SENS.**, **SLOPE**, and **LEVEL** settings can be made independently for each channel.

(6) SLOPE

This is not used so much by functions other than time interval measurement; however, it is effective when the jitter varies with the slope. For example, the period measurement is actually the time interval measurement between the slopes of the same polarity, and if jitter exists, the measurement value is also unstable.

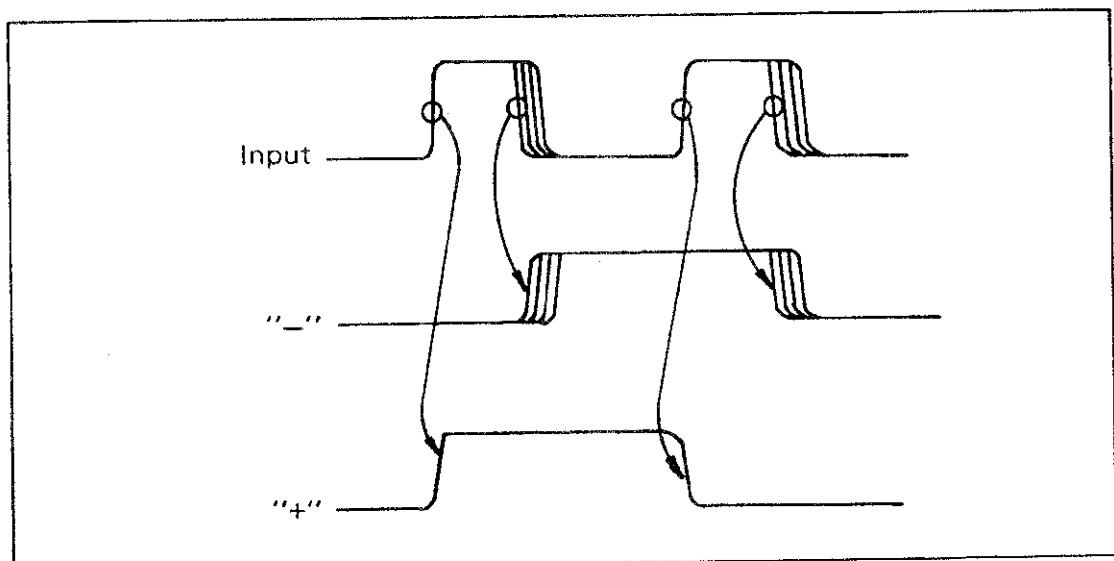

As shown in the preceding figure, stable measurement can be obtained by selecting either - or + slope.

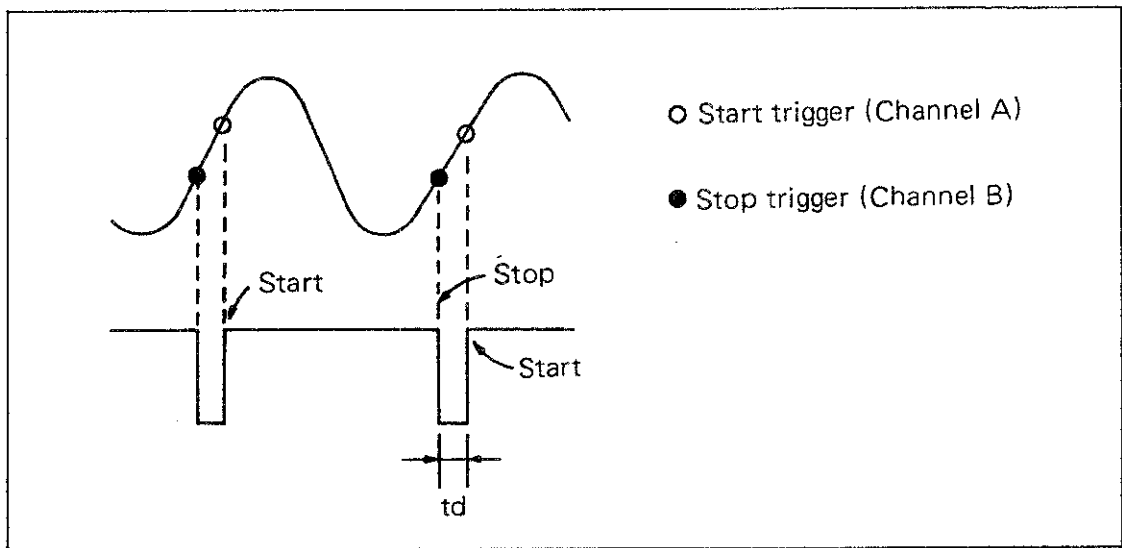

The start and stop triggers can be determined as shown above according to the trigger level. The time between the stop trigger and start trigger (t_d ; dead time = 50 ns) must be maintained.

5-2-2. LSI80-GC/SS

The basic section of the counter incorporates these two LSIs. The LSIs are controlled by the microprocessor via the data bus. LSI80-GC is an LS-TTL LSI having an integration scale of 500 gates. Its toggle frequency is 60 MHz or higher; the frequency of 120 MHz can be realized by externally connecting a 1/2 scaler. LSI80-SS, connected to LSI80-GC, is a CMOS LSI having an integration scale of 2,000 gates and toggle frequency of 12 MHz or higher.

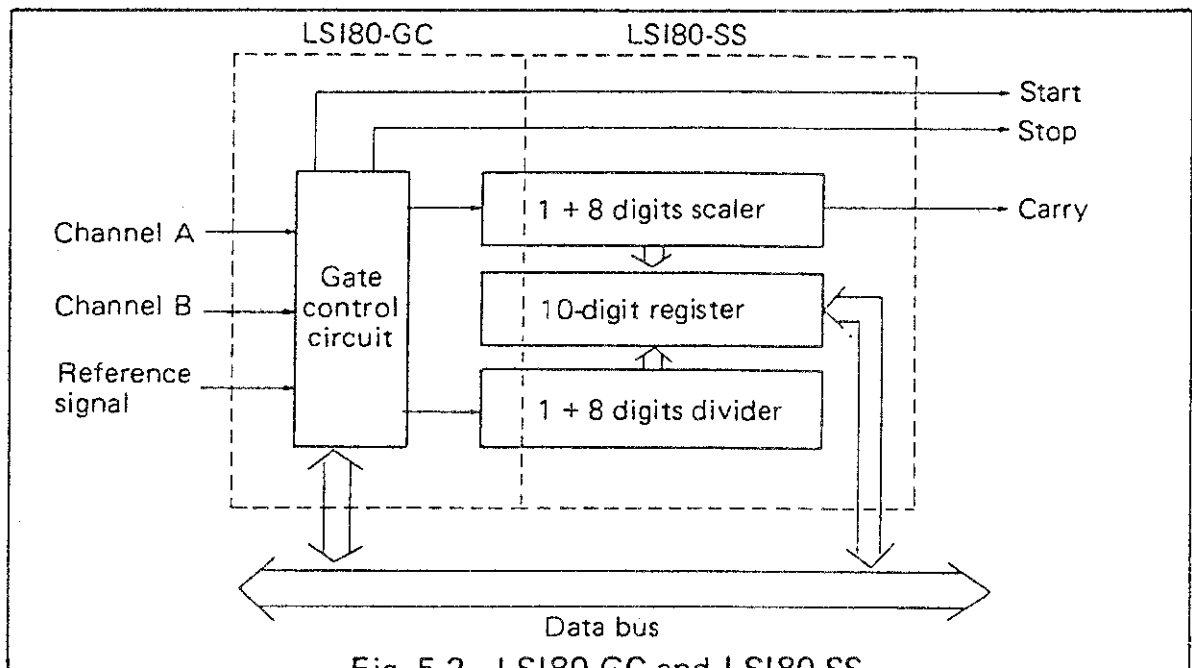
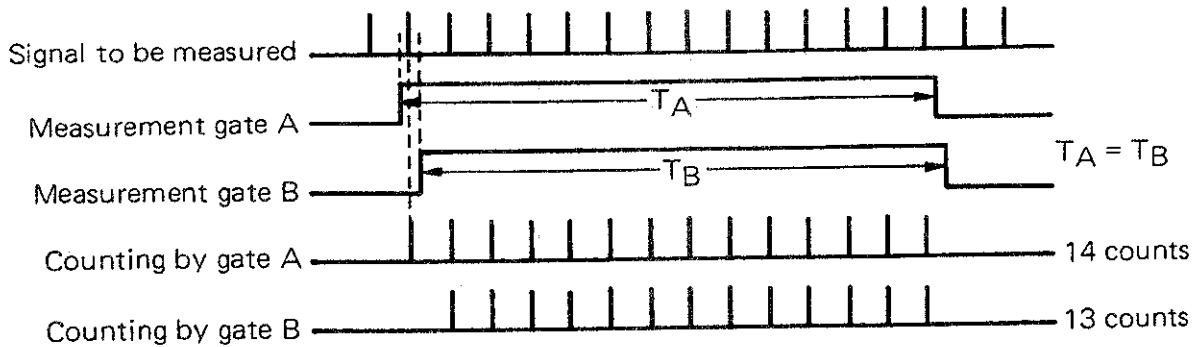

Fig. 5-2 LSI80-GC and LSI80-SS

5-3. Measurement Accuracy

5-3-1. Frequency Measurement (FREQ. A, C)

The measurement method employed here counts the number of repetitions of the signal to be measured per unit time and displays it as the frequency (c/s = Hz). As a consequence, the quantization error of ± 1 count as shown below occurs in the least significant digit.



This is expressed as follows:

$$\frac{1}{f_X \times T_G} = \pm \text{LSD of the display}$$

where: f_X = Measured frequency (Hz)
 T_G = Gate time (s)

The accuracies for different frequencies and gate times are shown below. **FREQ. C** uses a divide-by-twenty prescaler; the accuracy is reduced by 1 digit for the same gate time.

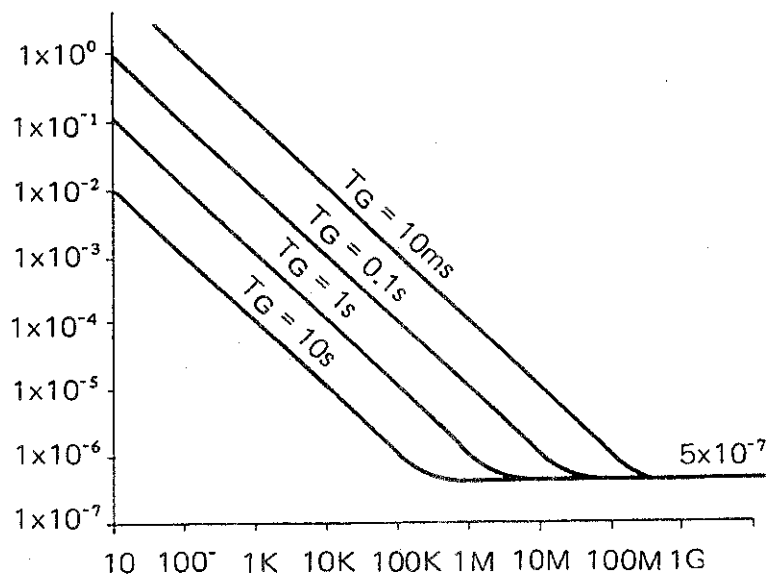

5-3-2. Frequency Measurement (FREQ. B)

The reciprocal scheme, which calculates the inverse of the period measurement result, is very economical and quick in response for measuring low frequencies with high precision. In this counter, the microprocessor, operating as a controller, performs inverse calculation and displays the frequency. The disadvantage of the reciprocal taking counters is that noise added to the signal directly affects the accuracy of the measured signal. Assume superimposed noise as illustrated below, and the error (called the trigger error) is as follows:

$$\text{Trigger error} = \frac{\Delta P}{P} = \frac{E_n}{\pi E_s} \dots\dots\dots \textcircled{1}$$

where: E_n = Noise voltage
 E_s = Voltage of the signal of interest

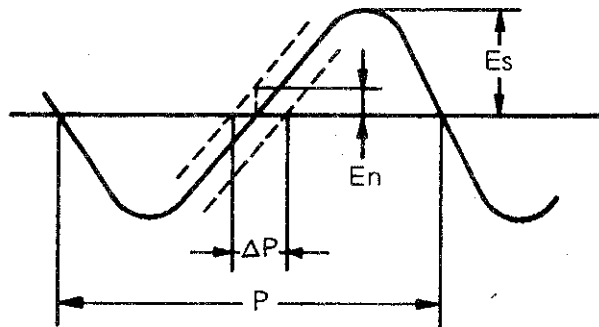

The lower the E_n/E_s ratio, the greater the accuracy. The counter naturally contains internal noise which must also be considered in determining accuracy. The internal noise in this counter is $100 \mu\text{Vrms}$ or less. Therefore, if the signal to be measured does not have any noise and the input voltage is 100 mVrms ,

$$\text{Trigger error} = \frac{100 \times 10^{-6}}{\pi \times 100 \times 10^{-3}} \cong 3.2 \times 10^{-4} \dots\dots\dots \textcircled{2}$$

To obtain greater accuracy, an average measurement is needed. The trigger error is averaged by expanding P in the above figure by 10^n periods:

$$\text{Trigger error} = \frac{1}{10^n} \times \frac{E_n}{\pi E_s} \dots\dots\dots \textcircled{3}$$

The counter performs this automatically; therefore, the higher the frequency, the greater the measurement accuracy. The relationship between the frequency, measurement time and the number of periods is shown on the next page.

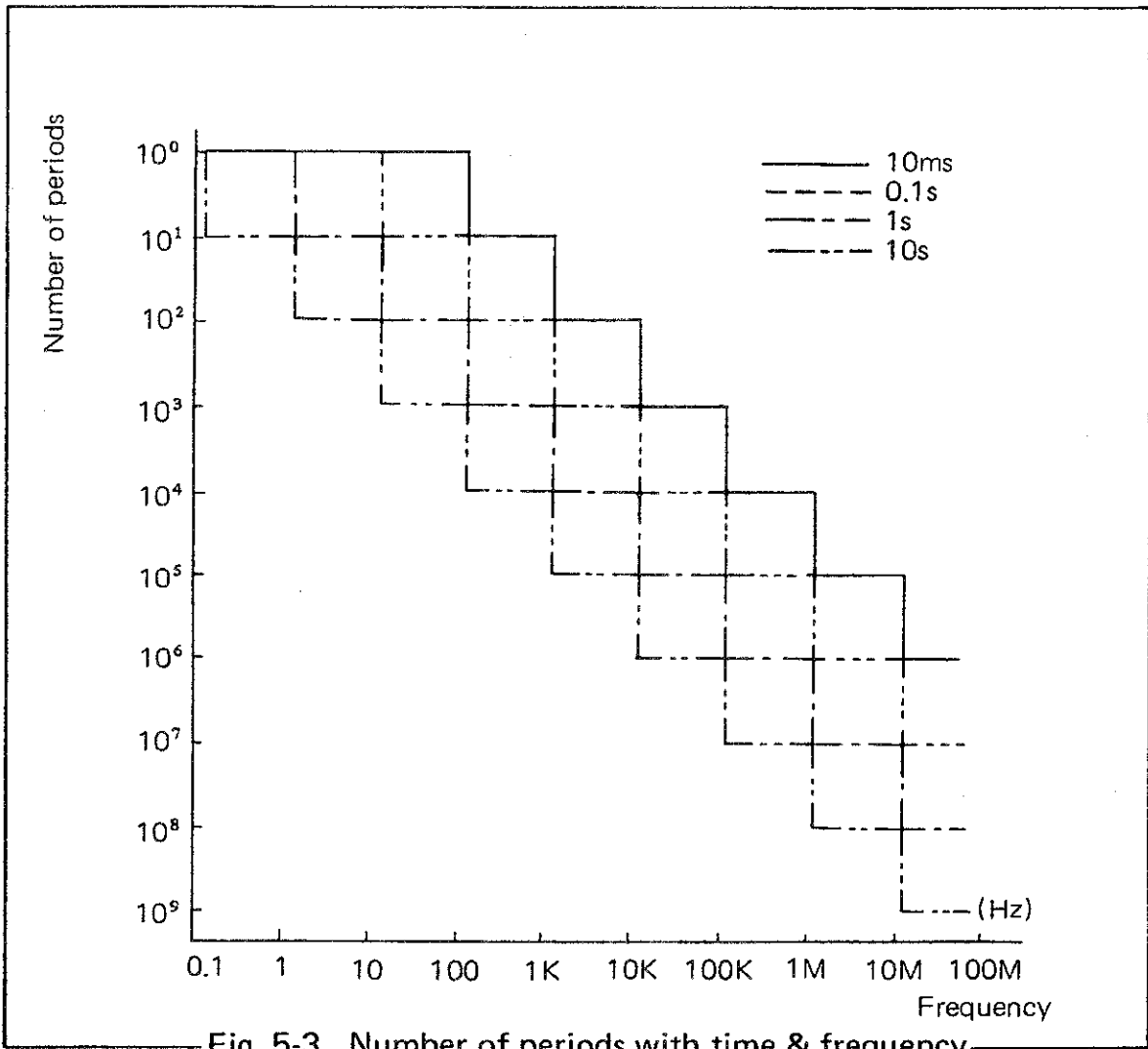

Fig. 5-3 Number of periods with time & frequency

The number of display digits is five for 10 ms, six for 0.1 s, seven for 1 s, and eight for 10 s.

5-3-3. Period Measurement (PERIOD B)

This is basically the same as the frequency measurement (FREQ. B). (See 5-3-2.)

5-3-4. Time Interval Measurement (T.I. A → B)

This is basically the same as the frequency measurement (FREQ. B) and period measurement (PERIOD B). The measurement time is dependent on the signal to be measured and noise riding along with it causes trigger error, which is calculated by equation ① in 5-3-2. Equation ① applies to a sine wave; for a pulse, however, the trigger error expressed with the slew rate (SR) would afford a better understanding:

$$\text{Trigger error} = \frac{1.4 \times \sqrt{(\text{counter internal noise})^2 + (\text{Noise on input})^2}}{\text{SR}} (\text{Srms})$$

The relationship between SR, amplitude, and frequency of a sine wave is shown below.

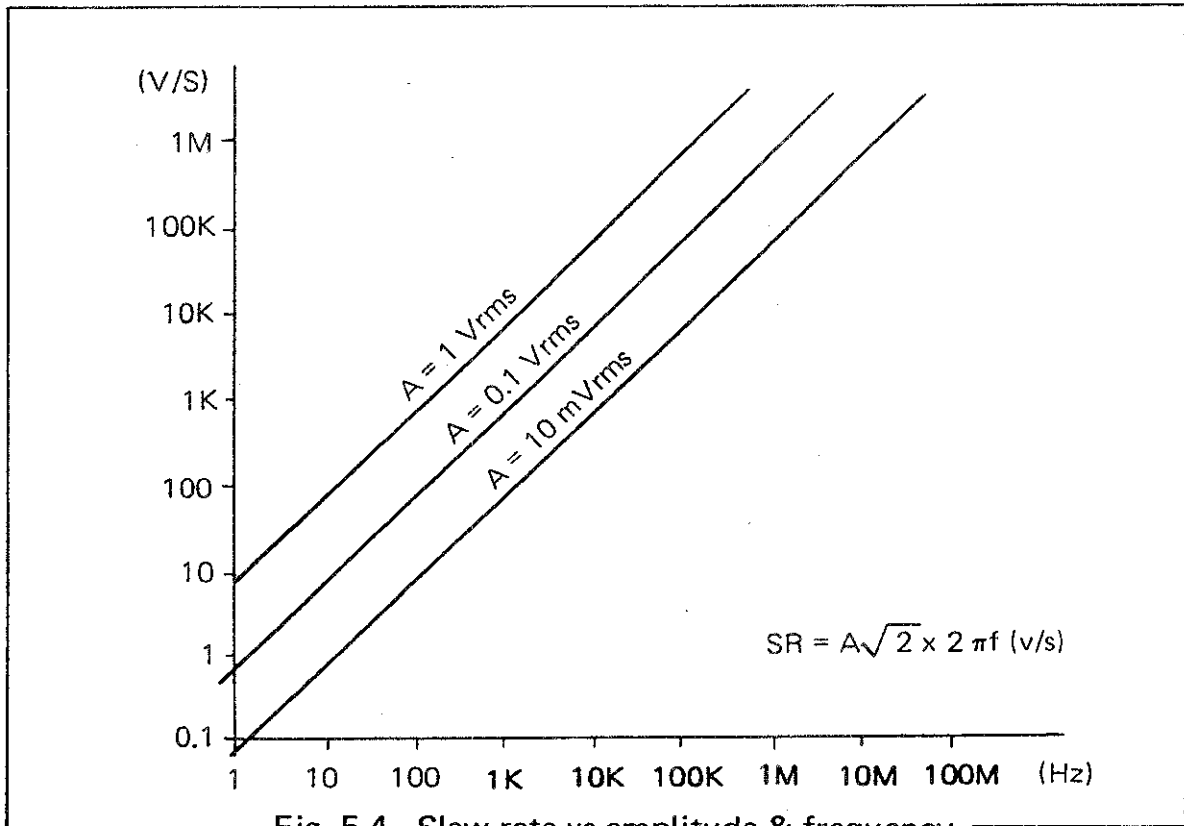

Fig. 5-4 Slew rate vs amplitude & frequency

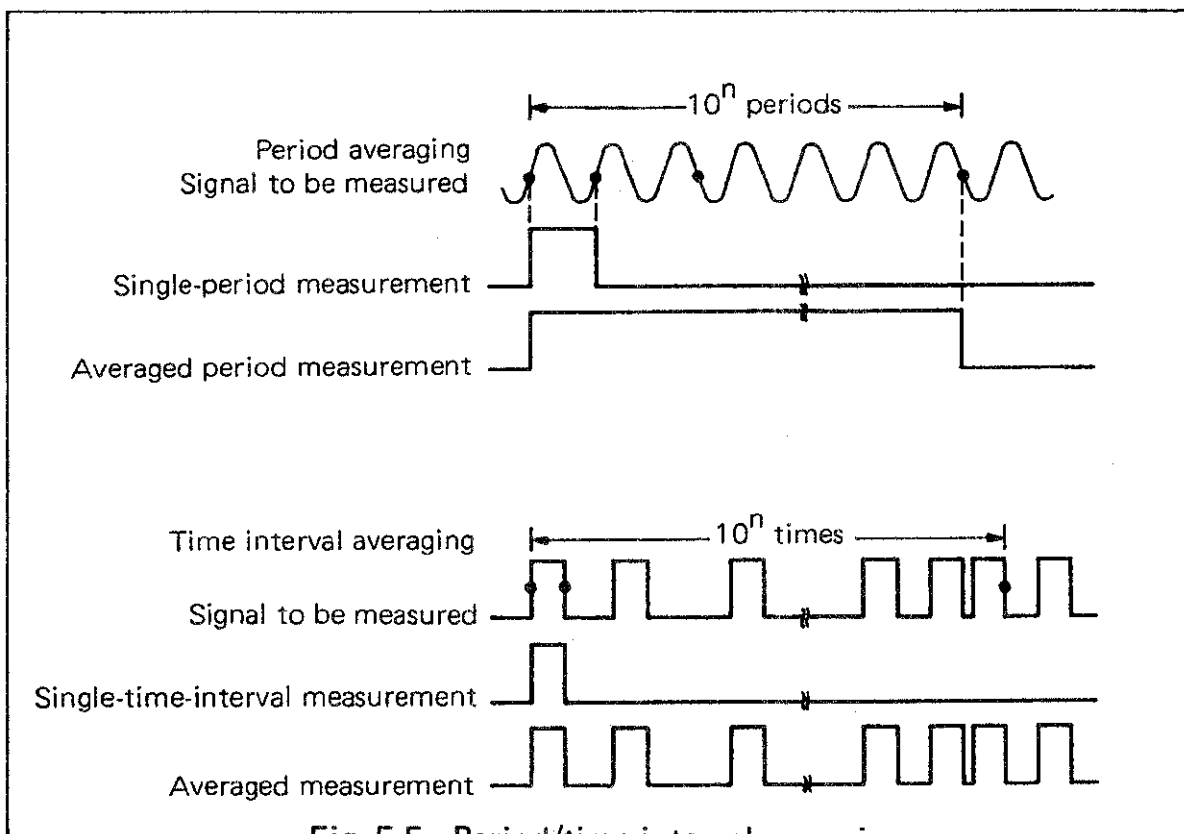

Fig. 5-5 Period/time interval averaging

In period measurement, the trigger error is reduced to $1/10^n$ for averaging number 10^n . In time interval measurement, on the other hand, the trigger error is reduced to only $1/\sqrt{10^n}$ for averaging number 10^n . This is because the averaging technique differs from that for the period measurement as shown; that is, counting is performed continuously from measurement start to end in period measurement whereas, in time interval measurement, counting is intermittent as shown in the figure on the preceding page and a ± 1 count error occurs at each counting. Therefore, if the signal to be measured is very stable, the accuracy is not improved by averaging.

SECTION 6 CALIBRATION

6-1. Introduction

In electronic counters, the most important factor affecting measurement accuracy is the frequency accuracy of the crystal oscillator that generates the internal time base. The frequency accuracy must be constant, or, if there is a slight variation, it must be negligible. To maintain the measurement accuracy of an electronic counter, periodically calibrate the counter to the frequency standard and care should be given to the operating environment.

6-2. Equipment Required for Calibration

Equipment	Specifications	Recommended model
Signal generator	Frequency: 10 ~ 1500 MHz Output voltage: 1 mVrms to 1 Vrms	
Pulse generator	Pulse width: 1 μ s or less Output: 100 mVp-p to 5 Vp-p Period: 10 μ s or more	
Digital voltmeter	Resolution: 1 mV or more	R6341A/B
Frequency standard	Stability: 5×10^{-9} or more	TR3110
Oscilloscope	Voltage: 10 mV/div. to 10 V/div. Sweep rate: 0.1 s/div. to 1 ns/div.	

NOTE: **TR5821/22/23/23H** should be warmed up for the specified time before operating.

TR5821/22/23: 15-25 minutes after power on
TR5823H: 24 hours after power on

6-3. Calibration for Each Section

6-3-1. Sensitivity

(1) INPUT A

① Setting

AC-AUTO-DC : AUTO
SLOPE : +
SENS. : X 1
SEP/COM : SEP
FILTER : OFF
GATE TIME : 10 ms

- ② Terminate **INPUT A** with 50 Ω , apply sine waves of 10 MHz, 25 mVrms from the signal generator, and set **FUNCTION** to **FREQ. A**.
- ③ Adjust R73 on the mother board so that a duty factor of the waveforms at TP10 is 1:1 on the oscilloscope.

(2) INPUT B

① Setting

AC-AUTO-DC : AUTO
SLOPE : +
SENS. : X 1
SEP/COM : SEP
FILTER : OFF
GATE TIME : 10 ms

- ② Terminate **INPUT B** with 50 Ω , apply sine waves of 50 MHz, 20 mVrms, and set **FUNCTION** to **FREQ.B**.
- ③ Adjust R78 on the mother board so that the waveforms at TP11 assume a duty factor of 1:1 on the oscilloscope.

6-3-2. Trigger Level

① Setting

AC-AUTO-DC : DC
SLOPE : +
SENS. : X 1
SEP/COM : COM
FILTER : OFF
GATE TIME : 10 ms

- ② Apply 10 MHz, 25 mVrms signal with the low-frequency signal generator to **INPUT A** terminated with 50 Ω .
- ③ Set **FUNCTION** to **FREQ. A**, set the **LEVEL** control (R54) of **INPUT A** in the center position, and rotate R80 on the mother board until count is obtained.
- ④ Set **FUNCTION** to **FREQ. B**, set the **LEVEL** control (R54) of **INPUT A** in the center position, and turn R79 on the mother board until count is obtained.

6-3-3. Squelch (TR5823 only)

① Setting

GATE TIME : 10 ms
FUNCTION : FREQ. C
SENS. : X 1
ANS : OFF

② Apply the signal of 600 MHz, 15 mVrms, through the signal generator to **INPUT C**.

③ Adjust R30 on the INPUT C board until the voltage at pin 7 of IC4 changes from high to low viewing the oscilloscope.

6-3-4. ANS

① Setting

GATE TIME : 10 ms
FUNCTION : FREQ. C
SENS. : X 1
ANS : ON

② Apply the signal of 1300 MHz, 17 mVrms to **INPUT C** with the signal generator.

③ Rotate R27 on the INPUT C board until count is obtained.

6-3-5. Time Base

① Setting

FUNCTION : FREQ. A
GATE TIME : 1 s
AC-AUTO-DC : AUTO
SLOPE : +
SENS. : X 1
SEP/COM : SEP
FILTER : OFF

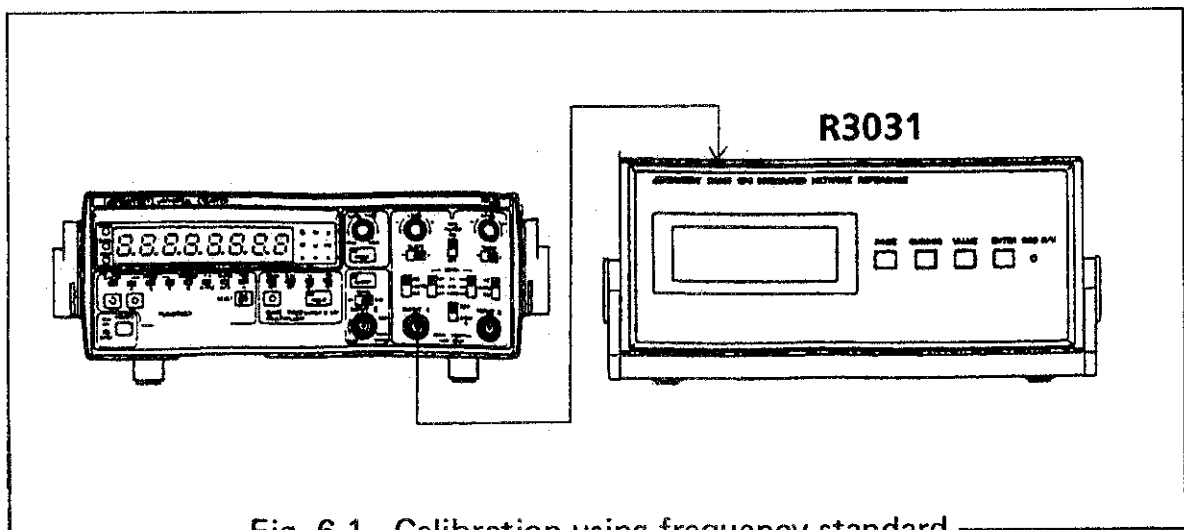

Fig. 6-1 Calibration using frequency standard

- ② Adjust **STD ADJ.** on the rear panel so the readout of 10.000000 MHz is obtained when the frequency standard output signal is 10 MHz.
The accuracy of this calibration is on the order of 1×10^{-7} . When **GATE TIME** is set to 10 S, a calibration accuracy is raised to the order of 1×10^{-8}

6-3-6. Automatic Trigger

- ① Setting

AC-AUTO-DC	:	AUTO
SLOPE	:	+
SENS.	:	X 1
SEP/COM	:	COM
FILTER	:	OFF

- ② Apply the signal with the pulse generator of pulse width of $1 \mu\text{s}$, duty factor of 1/10, and amplitude of +200 mVp-p to **INPUT A** terminated with 50Ω .
- ③ Set **FUNCTION** to **FREQ A**, connect the digital voltmeter to pin 2 of J22 on the dummy board, and rotate R72 to adjust the voltage to 100 mV. (See Figure 6-2.)
- ④ Set **FUNCTION** to **FREQ. B**, connect the digital voltmeter to pin 3 of J22 on the dummy board, and rotate R77 to adjust the voltage to 100 mV. (See Figure 6-2.)

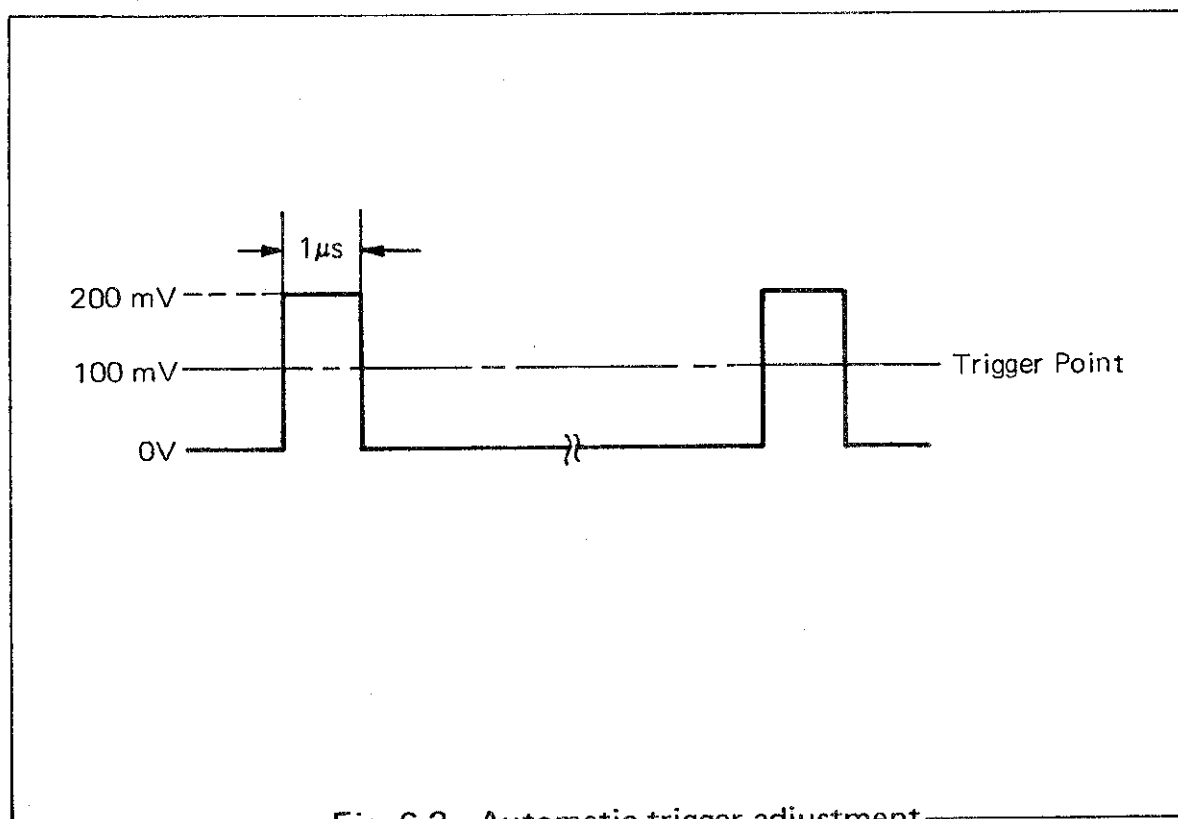

Fig. 6-2 Automatic trigger adjustment

6-4. Influence of Temperature and Line Voltage Variation on Stability

Since the reference oscillator used in this counter is not temperature compensated, the temperature rise caused by **POWER ON** and internal temperature change by power fluctuation affect the stability of the reference oscillator. Figure 6-2 shows the standard values of warm-up time and power fluctuation of this unit.

The warm-up time required (the time to reach a frequency deviation of $\pm 5 \times 10^{-7}$) is 25 minutes for the **TR5821**, and 15 minutes for the **TR5822/5823**.

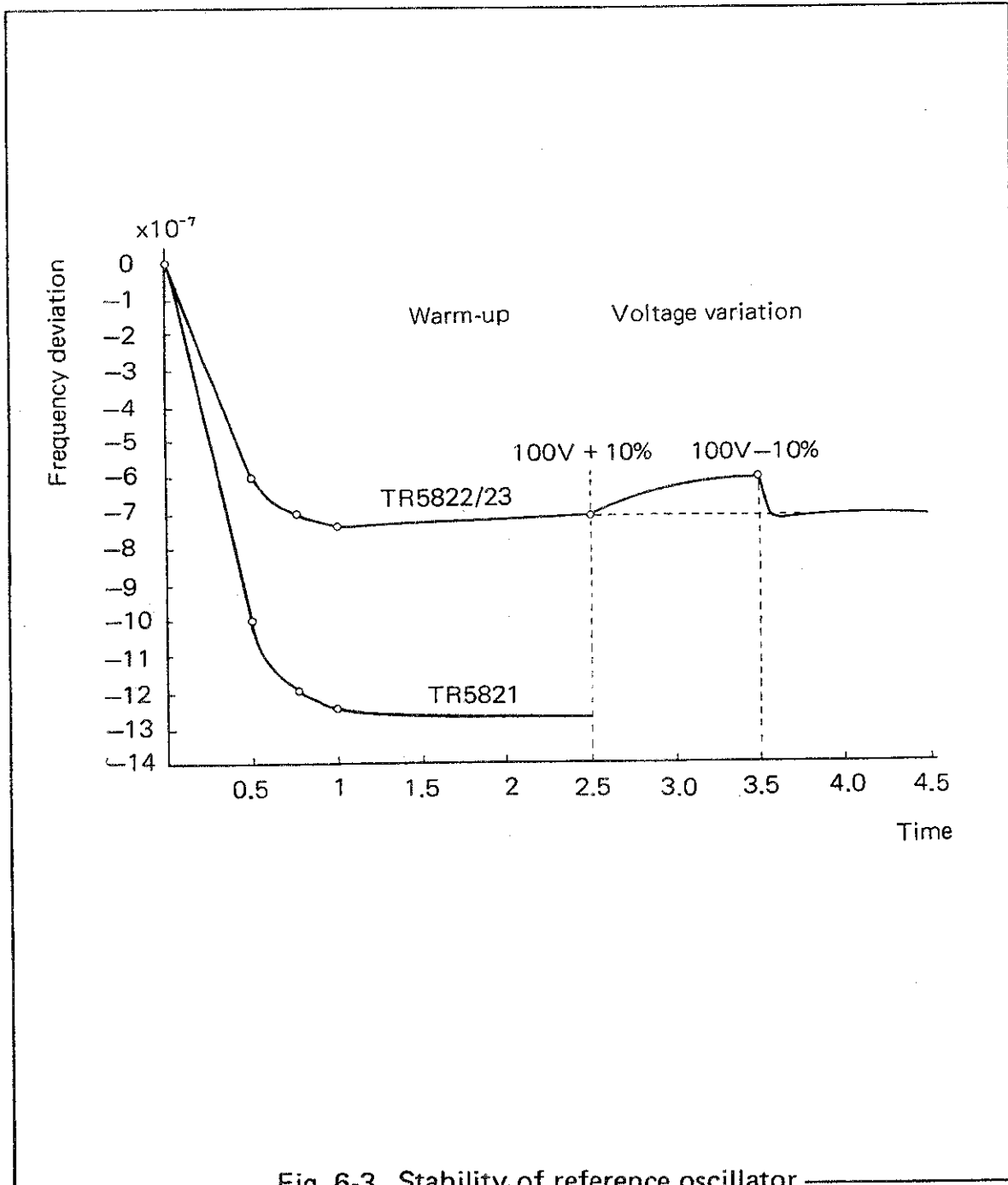

Fig. 6-3 Stability of reference oscillator

SECTION 7 CALCULATION UNIT TR1644 (ACCESSORY)

7-1. Name and Function of Keyboard

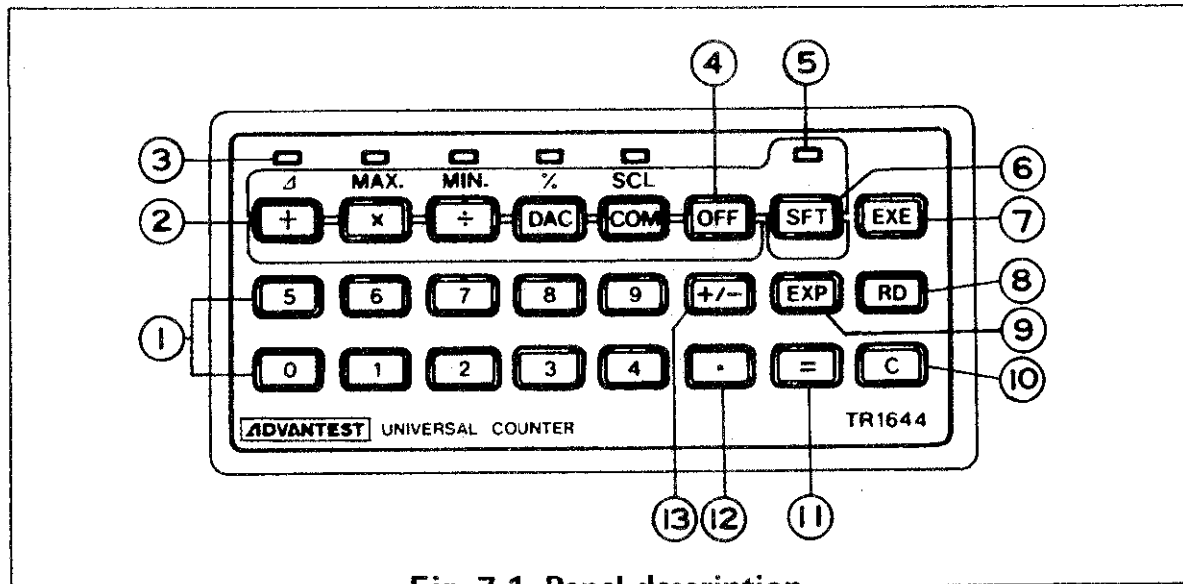
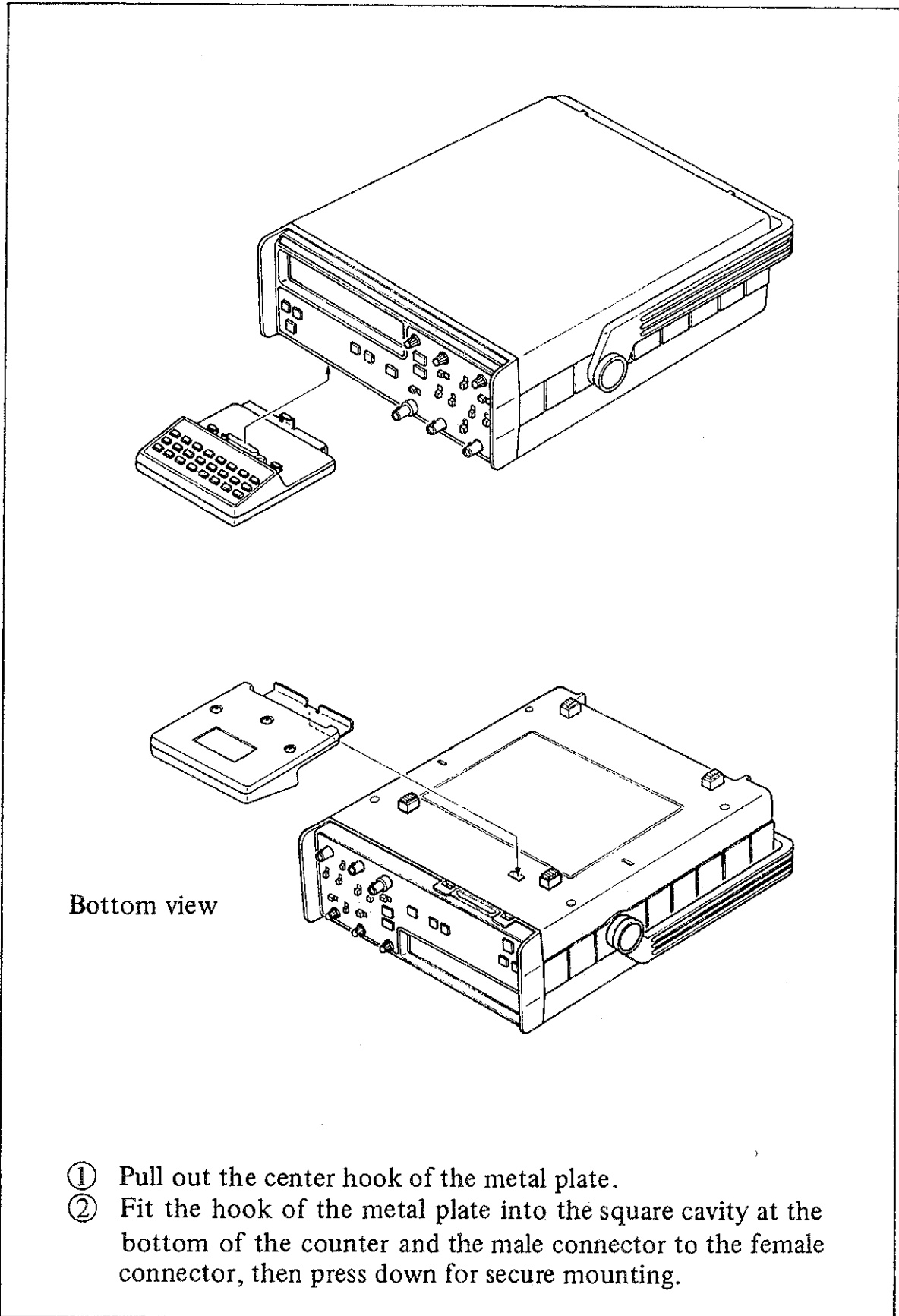

Fig. 7-1 Panel description

- ① Numeric keys : Keys for setting numeric values.
- ② Function keys : Press these keys as in the order of the calculation expression. The result is displayed by pressing **EXE** (arithmetic operation on measurement value) or **=**.
- ③ Function monitor : Displays the function being executed.
- ④ Function cancellation key : Cancels the calculation.
- ⑤ Shift monitor : Monitors the shift key operation.
- ⑥ **SFT (SHIFT)** key : Enables functions of labeling (sepia colored area) above the function keys.
- ⑦ **EXE (EXECUTE)** key : Executes calculation with the measurement value.
- ⑧ **RD (READ)** key : Reads out the data already loaded (contents of registers H and L).
- ⑨ **EXP (EXPONENT)** key : Sets the exponent.
- ⑩ **C (CLEAR)** key : Clears the readout.
- ⑪ **=** key : Displays the result of manual calculation.
- ⑫ **.** key : Places a decimal point.
- ⑬ **+/-** key : Exchanges + and - with each press of the key.

7-2. Calculation Unit Installation



- ③ Press in the metal plate toward the **TR1644** and lock it.

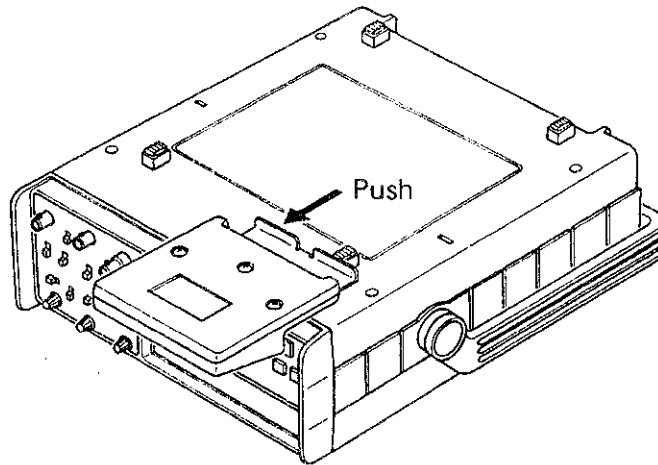

Bottom view

TR1644 is mounted.

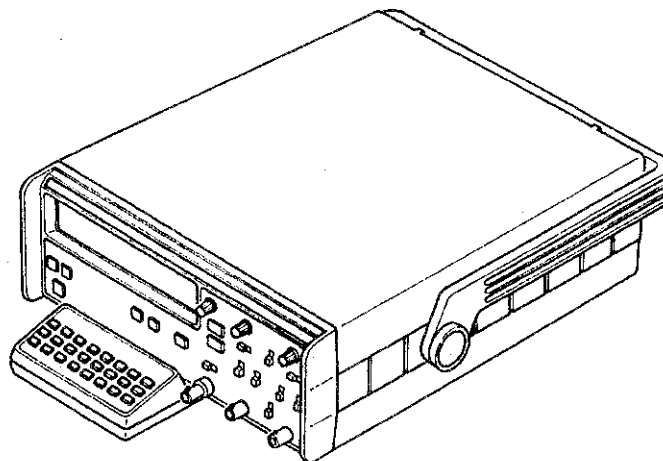

7-3. Operation Examples

① $\square \overline{A} \overline{L}$ is displayed when a calculation unit key is pressed during measurement. Display of $\square \overline{A} \overline{L}$ indicates that the calculation unit keys are ready for operation.

② Manual calculation execution

1. $12.3 \times 10^3 - 23 \times 10^2 = 10.0 \times 10^3$
 $12.3 \text{ [EXP] } 3 \text{ [+] [+/-] } 23 \text{ [EXP] } 2 \text{ [=]}$ 10.000000 k
2. $12 \times 6 = 72$
 $12 \text{ [X] } 6 \text{ [=]}$ 72.000000
3. $15 \div 0.3 = 50$
 $15 \text{ [÷] } 0.3 \text{ [=]}$ 50.000000
4. $13.56 \div 12 = 1.1300000$
 $13.56 \text{ [÷] } 12 \text{ [=]}$ 1.1300000
 $13.56 \div 3 = 4.5200000$
 3 [=] 4.5200000

③ Calculation with measurement value (Provided **FUNCTION** is CHECK, **GATE TIME** 10 ms.)

[+] Addition of measurement value (for subtraction, add a negative value). $\text{[+/-] } 1.23 \text{ [EXP] } 6 \text{ [+] [EXE]}$ 8.770M

[X] Multiplication of measurement value by a constant
 60 [X] [EXE] 600.00M

[÷] Division of a constant by measurement value
 1 [÷] [EXE] 100.00 n

[DAC] Resolution fixing and offset (D/A conversion mode)
 $-500 \text{ [EXP] } 4 \text{ [DAC] [EXE]}$ 500.

└──────────┘ Exponential digit of LSD

[COM] Comparison with set values
 $11 \text{ [EXP] } 6 \text{ [COM] [C] } 9 \text{ [EXP] } 6 \text{ [COM] [EXE] XXX; \overline{H} XXX}$

Stored in register H H→L Stored in register L (In)

Hi, In, or Lo is displayed accordingly when the contents of registers H and L are changed around 10×10^6 .

Hi	$H \leq x$	Relationship between the set values displayed and the measurement value
In	$H > x \geq L$	
Lo	$L > x$	

Δ	Display of [new measurement data – old measurement data]	
	+ SFT EXE	10.000M
		↓
		0.00
		↓
		0.00
		↓
		0.00
MAX	Measurement of maximum value	
	X SFT EXE	10.000M
MIN	Measurement of minimum value	
	÷ SFT EXE	10.000M
%	Measurement of % deviation (from 9 MHz)	
	9 EXP 6 DAC SFT EXE	11.11
SCL	Compound calculation (x ± L)/H (scaling)	
	10 COM C +/- 9.5 EXP 6 COM SFT EXE	50.00 k
	Stored in register H Stored in register L	
OFF	Defeat of functional calculation	

7-4. Notes on Use

- (1) Be sure to set a numerical value before executing another calculation after executing Δ, MAX, or MIN. In failure of numerical setting, turn off the power and on again.
- (2) The setting range is ±9999.9999E ±9
- (3) For **COM** and **SCL**, registers H and L are selected by pressing the **C** key. For other functions, register H alone is displayed.
- (4) The set data, in 8 digits for mantissa and 1 digit for exponent, is displayed in the following format:

- 1 2 3 4 5 6 7 8 . E - 9 H

└──────────────────┘
Displayed digits

Each time the **RD** key is pressed, the numeric display part moves 1 digit to the right until the following display is obtained:

- 1 2 3 4 5 H

- (5) The result display differs from the display of the set data explained in (4). The numeric part is a maximum 8 digits, or 7 digits when a minus sign is displayed. The decimal point is placed somewhere in the three significant digits and the suitable unit is selected from among G, M, k, m, μ , n and p, (equivalent to the order of 10^9 , 10^6 , 10^3 , 10^{-3} , 10^{-6} , 10^{-9} , 10^{-12}).

For example, 123456.78 is displayed as

1 2 3 . 4 5 6 7 8 k
- 1 2 3 . 4 5 6 7 k

- (6) For the **SFT** involved function, be sure to press the **SFT** key each time numerical value is set and function key is pressed since the shift capability is aborted (LED lamp goes off) by pressing a function key.
- (7) The calculation capability is invalid when the counter is set to **CHECK** **MASK**, or **TOT**.
- (8) When the **OVER** lamp goes on, the result is invalid. Set **GATE TIME/MULTIPLIER** so the **OVER** lamp does not go on.
- (9) When the $(x \pm L)$ results in 0 in the **SCL** (compound calculation) capability, the counter comes to a halt displaying E 24. For the continuous measurement of such factors as a deviation (indicated in ppm), therefore, select the value of L so that $x \pm L \neq 0$ or set up the **GATE TIME/MULTIPLIER** to obtain smaller digits of measurement data (x) than the set value (L).

SECTION 8 OPTIONS

8-1. BCD Output

(1) Performance

Data capacity : Mantissa 7 digits, exponent 1 digit, unit
 Data output : 8-4-2-1
 Unit output : 8-4-2-1
 Output level (TTL) : Low level: 0 V to +0.4 V
 High level: +2.4 V to +5.25 V
 Output connector : Amphenol 57-40500 or equivalent

(2) Output signal table

1	GND (0 V)	26	2^0	} $\times 10^4$
2	2^0	27	2^1	
3	2^1	28	2^2	
4	2^2	29	2^3	
5	2^3	30	2^0	} $\times 10^5$
6	2^0	31	2^1	
7	2^1	32	2^2	
8	2^2	33	2^3	
9	2^3	34	2^0	} $\times 10^6$
10	2^0	35	2^1	
11	2^1	36	2^2	
12	2^2	37	2^3	
13	2^3	38	2^0	} Function
14	2^0	39	2^1	
15	2^1	40	2^0	} Unit
16	2^2	41	2^1	
17	2^3	42	2^2	
18	2^0	43	2^3	} Decimal point
19	2^1	44	2^0	
20	2^2	45	2^1	
21	2^3	46	2^2	
22	2^0	47	Print command signal	
23	2^1	48	Print end signal	
24	2^2	49	NC	
25	2^3	50	GND (0 V)	

(3) Data output codes

Output	Character	Code			
		8	4	2	1
Data (Mantissa and exponent)	0	0	0	0	0
	1	0	0	0	1
	2	0	0	1	0
	3	0	0	1	1
	4	0	1	0	0
	5	0	1	0	1
	6	0	1	1	0
	7	0	1	1	1
	8	1	0	0	0
	9	1	0	0	1
	Space	1	1	1	1
	-	1	0	1	0
Decimal point	10 ³		1	0	1
	10 ⁴ (LOWER)	1	1	1	0
Function	* (Overflow)			0	1
	Space			1	1
Unit	Hz	1	1	1	0
	s	1	0	1	1
	Space	1	1	1	1
	rpm (exponential position at 10 ¹ in case of s)	1	0	0	0
	* (exponential position at 10 ¹ in the absence of unit)	1	1	0	0

(4) Print format

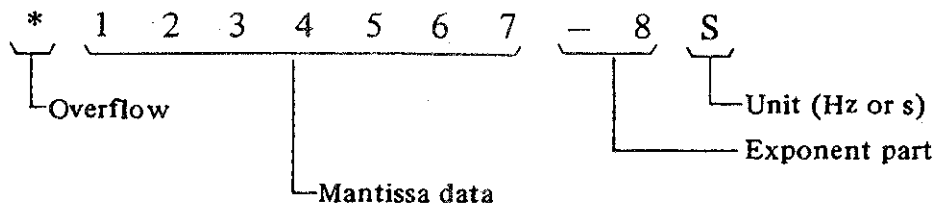

The mantissa data consists of the upper seven digits of the display and its decimal point locates on the right side of its upper four digits. (By interchanging a mini jumper at the LOWER character on the BCD OUTPUT board [BLB-020959], referring to the following figure, the mantissa data can be switched to the lower seven digits of the display. In this case, its decimal point shifts to the right side of its upper three digits.)

Only one digit position is provided for the exponent part. If the exponent part consists of two digits, an asterisk is printed at the unit position; when the unit is s, rpm is printed.

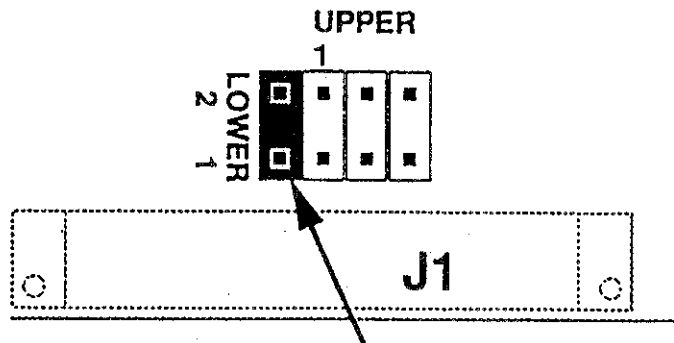

Move the mini jumper to a pair of the pin 1 and 2 of J3.

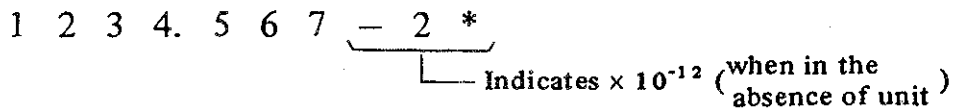

Note: For **FREQ. B**, the data is always printed in seven digits regardless of the number of digits in the readout.

(5) Print command signal (TTL level)

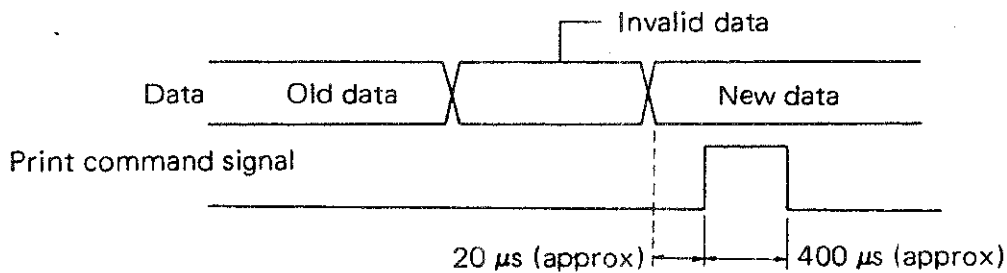

(6) Print end signal (TTL level)

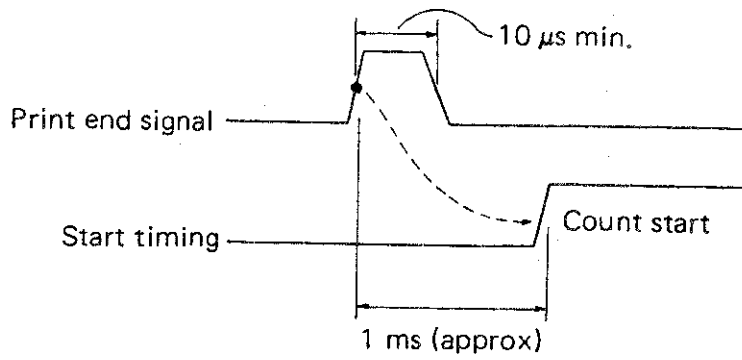

(7) **COM** mode (with the TR1644)

Outputs an electric signal (digit of 10^6) for GO/NO-GO decision to activate the audible tone, without using the display of this unit. The electric signal (code) that corresponds to each display in the **COM** mode is shown below.

H	0	0	0	1
1 n	0	0	1	0
L 0	0	1	0	0
	2^3	2^2	2^1	2^0

Digit of 10^6

8-3. High-stability Reference Oscillator (TR5823 only)

(1) Performance

Internal time base : 10 MHz

Aging rate : 5×10^{-8} /day

Temperature stability : 1×10^{-7} , 0°C to +40°C

Internal reference output : Frequency: 10 MHz

Output voltage: 1 V_{p-p} to 2 V_{p-p}

Output impedance: 500 Ω (approx)

External reference input : Frequency: 10 MHz

Input voltage: 1 V_{p-p} to 10 V_{p-p}

Input impedance: 500 Ω (approx)

The high-stability reference oscillator is standard on the **TR5823H**.

APPENDIX A TABLE OF SIGNALS

Signal	Meaning	Explanation
ANS	Automatic Noise Suppressor	Rejects superimposed harmonic noise
ATT	attenuator	Attenuates the incoming signal amplitude by a factor of 10 or 100
CLK	clock	Clock to control LSI80-SS (connected to NX)
CLS	closure	Command signal to close the gate
CNT	count	Counting signal from INPUT C board to mother board
DB	data bus	4-bit data bus
DIV	divider	
DRST	divider reset	
ERST	external reset	Reset for the peripheral circuits of LSI
EVL	envelope	Envelope signal for input C burst
EXI	external input	Data input to extend the digits for LSI
EXG	external gate	High-speed gate signal for LSI
FLT	filter	Low-pass filter to reject noise on low-frequency measurement
HV	high voltage	High-voltage signal for TR5820
INA	Input A	
INB	Input B	
IND	indicator	Blinks to indicate the triggered state
INH	inhibit	Panel switch operation inhibited (remote)
LCRY	log carry	Carry signal to control logarithmic signal
LOG	logarithmic signal	10^n period signal (to generate gate time)
MKSP	mask stop	Indicates termination of masking
MKT	masking time	Mask time signal (by charging C-R)
MKST	mask start	Indicates start of masking
NX	2^n of STD	Clock to control LSI80-SS
OFW	overflow	Condition in excess of the display capacity
REF	reference	DC voltage as a standard for incoming signal
REFA	reference A	DC voltage as a standard for INPUT A
REFB	reference B	DC voltage as a standard for INPUT B
REM	remote	Remotely controlled state via GPIB-compatible external controller
RTL	return line	Signal connected to panel switch
SCA	scaler	
SCL	scan line	Panel switch read signal

Signal	Meaning	Explanation
SEL	select	Selection of data on the data bus: address (low) or data (high)
SLPA	slope A	Triggers on the leading and trailing edges in the input A measurement
SLPB	slope B	Triggers on the leading and trailing edges in the Input B measurement
SRST	scaler reset	Reset signal output terminal for scaler
STA	start	
STP	stop	
STD	standard	
STR	strobe	Strobe signal for data bus
STRB	strobe	Strobe signal for display data
XTL	crystal	Internal time base for LSI connected to coil

APPENDIX B GLOSSARY

Acquisition Time

Acquisition time means the time from counter resetting to the start of counter operation. The acquisition time of ordinary counters is virtually zero, whereas microwave-band counters require a certain acquisition time. For the **TR5200** series counters of ADVANTEST, the acquisition time refers to the time required until the internal oscillator is phase locked to the input signal.

ALC (Automatic Level Control)

A function to detect and correct the DC fluctuation in the circuit caused by temperature drift from the input terminal to the output of the wide-band amplifier.

ANS (Automatic Noise Suppressor)

ADVANTEST's patented technique.

A circuit that automatically suppresses the noise riding on the signal to be measured.

Automatic Filter

Cutoff frequency is automatically selected according to the incoming frequency to eliminate random noise or noise added on the input signal, thereby preventing errors associated with noise. Automatic filter makes up for the disadvantages that the ANS capability contributes little to the suppression of random noise, impulse noise or noise larger than the signal of interest while it serves well for suppression of the superimposed noise.

Automatic Trigger Setting

Trigger level setting is quite difficult and bothersome when the signal to be measured is small. This setting operation is simplified by the automatic trigger setting. Trigger level is automatically set at the 50% level between the maximum and minimum peaks of the input signal. This capability facilitates the trigger level setting on the pulsed signal with the offset voltage or of different duty cycles, and minimizes false counting.

Averaging

Two circuit methods are usually used for averaging in electronic counters. One is used in the time interval measurement to count each time interval with the counting circuit and accumulate. Let N be the number of measurements, and $\pm 1 \text{ count}/\sqrt{N}$ is part of measurement precision. The other method is the one used in period measurement to form a gate with the period signal to be measured to measure the gate time with the internal time base. One factor of measurement precision is $\pm 1 \text{ count}/N$. Both averaging methods are used to enhance measurement precision of electronic counters; however, the inherent error factors inside the instrument (propagation delay time difference, Schmitt trigger circuit hysteresis band) cannot be improved. Therefore, the upper limit of the number of effective measurements accrues. In using the averaging function, the $\pm 1 \text{ count}$ error must be guaranteed to occur at random. A counter usually sends the signal to be measured to the counter gate circuit completely asynchronous with the internal time base and the error can be regarded to occur at random.

Bandwidth

For electronic counters, noise is a cause of counting errors and must be considered in relation to sensitivity.

The bandwidth switch is used to remove the high-frequency component (see figure below) with a low-pass filter of 10 MHz, 5 MHz, etc. This function is useful in measurement of oscillation and multiplied waves in a multiplier circuit.

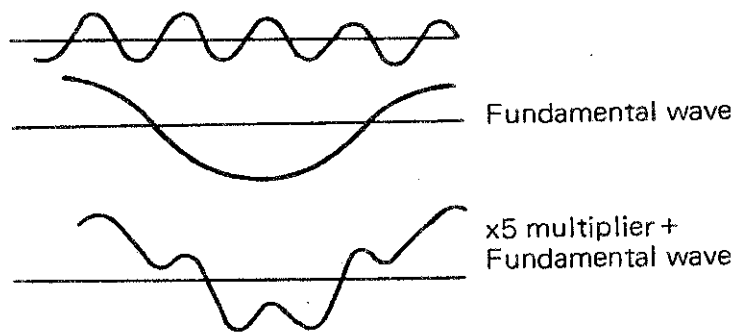

COM-SEP Switch

A switch to be selected to suit the signal to be measured in time interval measurement. When this switch is set to COM., the start and stop signals are internally connected enabling a time interval measurement on a single signal. SEP. switch separates the start and stop signals, requiring the two signals, of start and stop, to be measured. (COM: Common; SEP: Separate)

Counting Resolution

The least significant digit on the readout. Counting resolution differs with gate time. At a gate time of 1 second, the resolution is 1 Hz with a typical counter.

Direct Counting

The direct counting is the most fundamental method to measure the frequency. (See the figure below.) This scheme is widely used from the audio frequency band to the UHF band. In the direct counting method, the upper limit of frequency measurement is determined by the gate time and the frequency resolution. Enhancement of the performance of the semiconductor devices and advanced circuit board technology have realized a counter of 1 GHz utilizing the direct counting techniques.

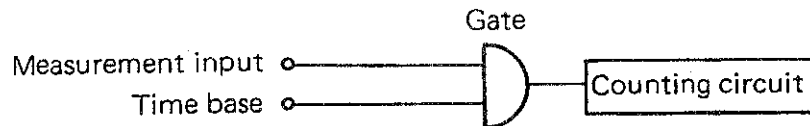

Expanding Reciprocal Method

The method used by electronic counters to measure a period, execute inverse calculation ($1/\text{period}$), and display the frequency is called the reciprocal method.

The main feature of this method is that, in period measurement, it enables frequency measurement of high-resolution and high-precision up to the order of the internal time base. For example, let the time base be 100×10^{-9} s, then 7-digit display is always possible when a frequency (10 MHz or less) is measured at a gate time of 1 second. To obtain a 10-digit display at a gate time of 1 second with this method, the internal time base must be 100×10^{-12} s (equivalent to 10 GHz). To realize a 10 GHz time base, the time expander method is used together with the reciprocal method, thus enabling a high-resolution high-precision frequency measurement. This method is called the expanding reciprocal method. (* See Time Expander Method.)

Gate Time

The time during which a counter measures the input signal. During this time, the GATE lamp usually goes on to notify the user that the input signal is being measured.

Input Coupling

There are two input coupling methods: the AC coupling that cuts out the DC input signal and passes the AC component alone, and the DC coupling to measure low frequencies.

Masking

With a masking function, regardless of the magnitude of noise, desired signal alone is made available by inhibiting for a required period of time the wave-shaped output. By adjusting the masking time, this function makes possible the measurements of the signal in noise including a chattering noise or the modulated wave signal.

Oven Lamp

A lamp that indicates activation of the crystal-oven heater and the internal reference circuit when the counter is connected to the AC power source regardless of the POWER switch operation.

Prescaler

The prescaler divides the input frequencies by a factor of n with a divider for counting. (See the figure below.) In this case, the counting result is $1/n$ of the actual frequency; therefore, the time base is multiplied by n to display the frequency measurement. This requires a gate time equal to n times that required for the direct counting method; with the same gate time, the resolution is $1/n$. In the prescaler, the upper limit of the measured frequency is determined by the frequency resolution of the divider. The gate is operated by the $1/n$ frequency, enabling measurement of higher frequencies than by the direct counting method. At present, a 1.5 GHz prescaling counter is available.

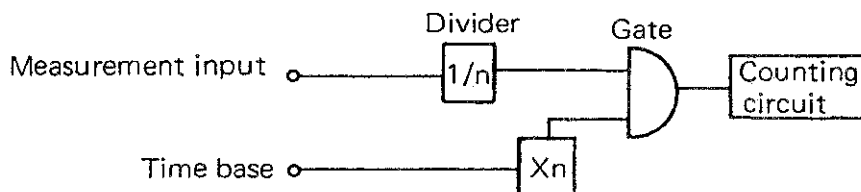

Sample Rate

A function to continuously vary the display time of the measurement result. As a matter of fact, the gate time is determined by the resolution of the counter. The display time can be changed by varying the time from the end

of a measurement to the start of the next measurement by using the sample rate function. Thus, the data display time can be altered by varying the sample rate.

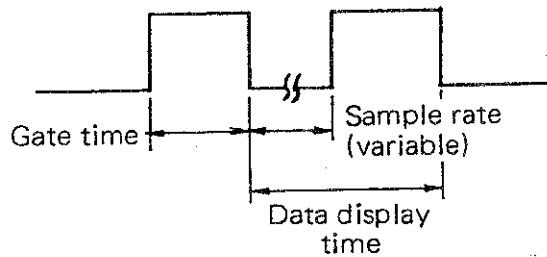

$$\text{Data display time} = \text{Gate time} + \text{Sample rate time}$$

Time Base, Internal/External

Frequency counters are used for measuring time or counting the number of pulses during a certain period of time. To obtain an accurate measurement result, a time base generator is needed to generate an accurate time. Most counters incorporate a crystal oscillator as the internal time base generator. The accuracy of this generator determines the accuracy of the frequency counter.

If a generator with greater accuracy than the built-in generator is externally available, greater measurement accuracy of the counter is obtained by replacing the internal generator with the output of the external generator. The output of this external generator is called the external time base.

Time Expander Method

The \pm count error caused by the relationship between the electronic counter internal time base (for example, 10 MHz) and the time interval to be measured or 1-cycle time is used as a significant time value. Let the difference time occurring at the leading edge of the time to be measured be ΔT_1 and the difference time occurring at the trailing edge be ΔT_2 , then the time to be measured $T_x = N \cdot T_0 \pm \Delta T_1 - \Delta T_2$ (where T_0 = internal time base, N = positive integer). $\Delta T_1 - \Delta T_2$ can be read at a better precision by a factor of 100 or 1,000 by converting the difference times to analog voltages by a high-speed time-voltage converter, then A/C converted with a high speed and high precision. Assuming the time base to be 100×10^{-9} s, T_x is equal to resolution 1×10^{-9} s or 100×10^{-12} s. This method of expanding the difference time is the time expander method.

Time Interval Average, Period Average

Counters can measure period and time interval. With a single measurement, the display is unstable and difficult to read or the measurement value is not

reliable if the input signal is interfered with noise or unstable. To solve this problem, counters have a feature to average 10 or 100 measurement values to reduce the influence of noise and input variation. This function is called the time interval average and period average to distinguish from a single measurement. Time required for average measurement is as many times longer as the number of averages taken.

Trahet Method

ADVANTEST's patented technique (US PAT. No. 3932814).

This method uses a YIG tuning oscillator with excellent linearity, taking advantage of the transfer oscillator and the heterodyne conversion techniques.

Trigger Level

When a signal is input to a frequency counter, the input signal must cross a certain level (also called the threshold value) for the counter to sense it as a signal and measure it. This level is called the trigger level. The level can usually be varied with a potentiometer, etc.

Trigger Monitor Output

A signal output from the trigger monitor circuit as an auxiliary means when a counter is measuring time interval. An oscilloscope (with Z-axis modulation terminal) shows intensity modulation on the waveform for each gate time. The measured portion on the trace is intensified as shown below.

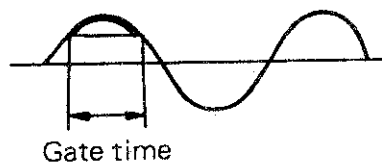

Trigger Slope

For a frequency counter to sense an input signal, the input signal should meet the two requirements. One is that the signal must cross the trigger level, and the other is that the slope of the input signal must match the preset trigger slope. With the trigger slope set to plus (+), the counter senses the input signal when the input signal crosses the trigger level from minus (-) to plus (+).

Rackmounting

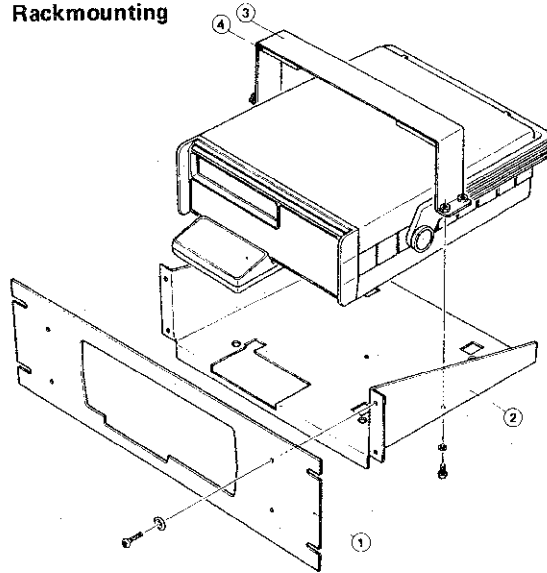

Dimensions of chassis (2)

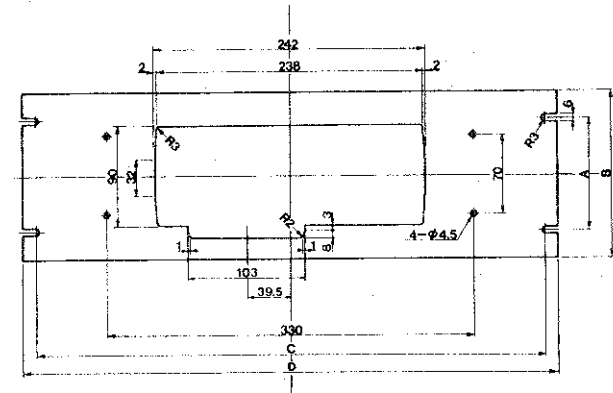
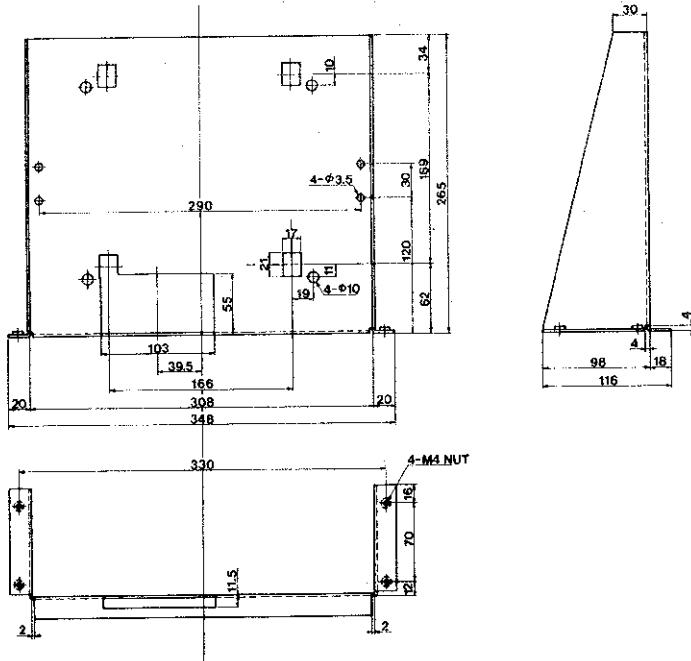

For installation with the TR1644

Dimensions of panel (1)

For installation without the TR1644

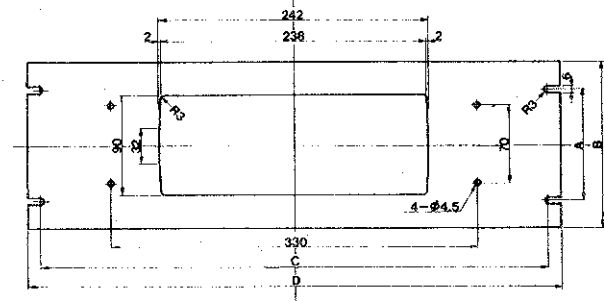

Unit: mm

Name	Stock No.	A	B	C	D
Panel mount set (2 + 3 + 4)	A02006	/	/	/	/
Rackmounting panel (EIA specifications)	A02407	89	132	458	482
	A02408 (with the TR1644)				
Rackmounting panel (JIS specifications)	A02208	100	149	456	480
	A02209 (with the TR1644)				

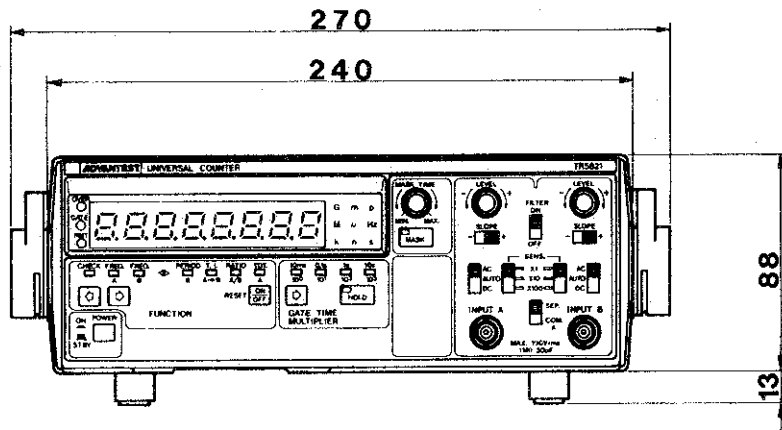

FRONT VIEW

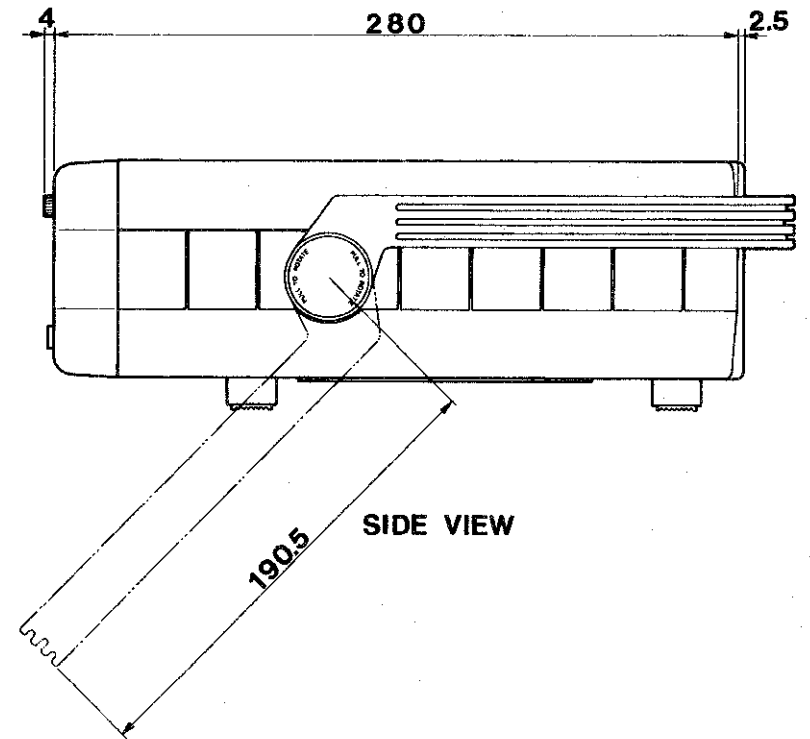

SIDE VIEW

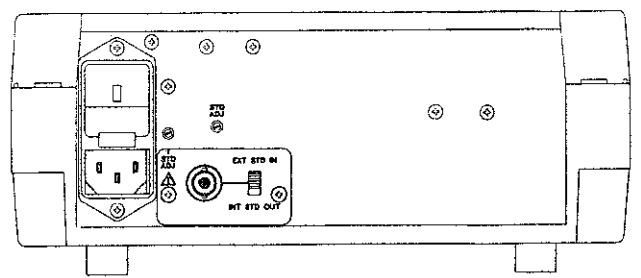

REAR VIEW

Unit: mm

TR5821
EXTERNAL VIEW

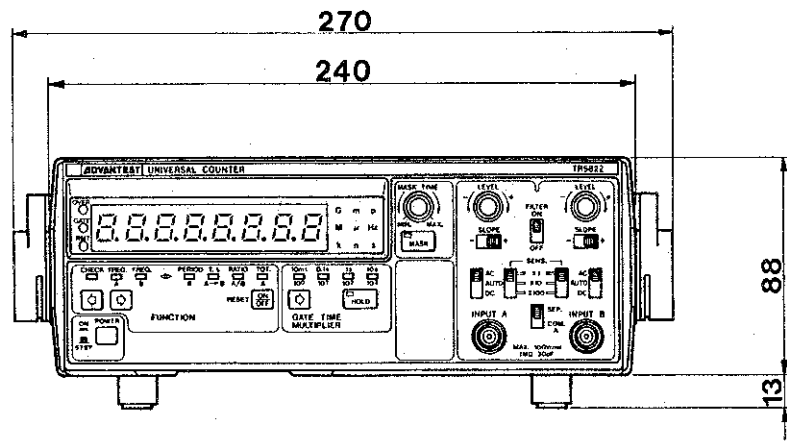

FRONT VIEW

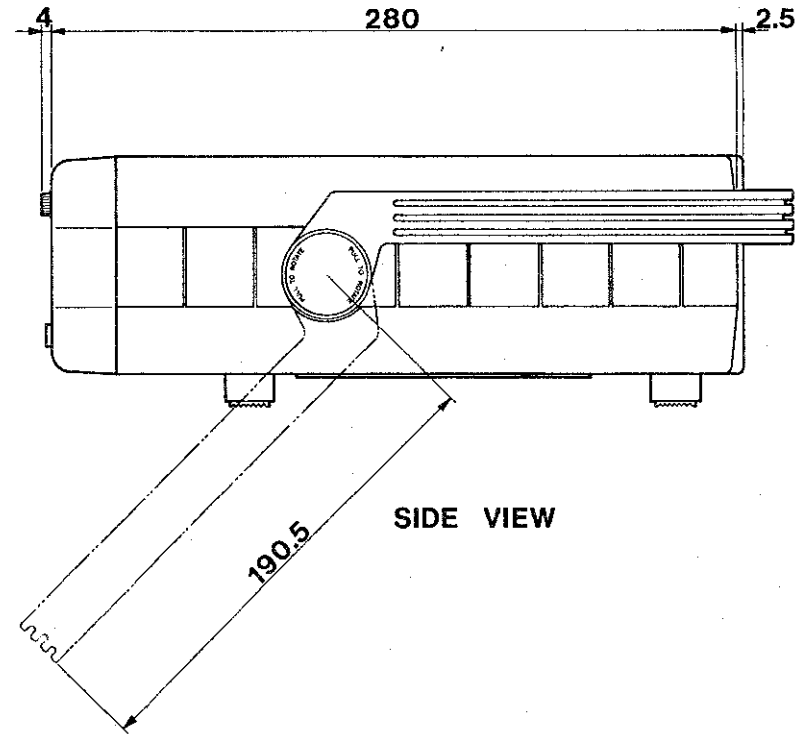

SIDE VIEW

Unit: mm

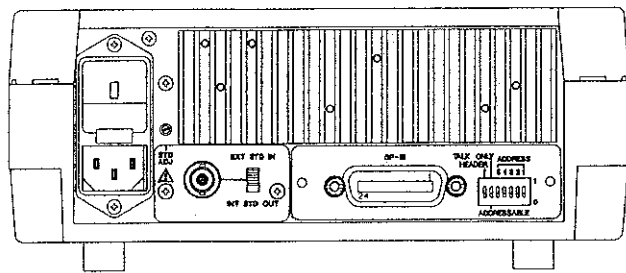

REAR VIEW

TR5822
EXTERNAL VIEW

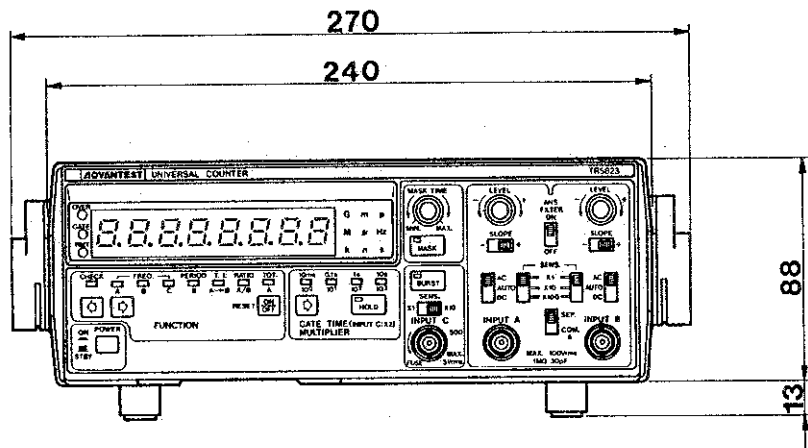

FRONT VIEW

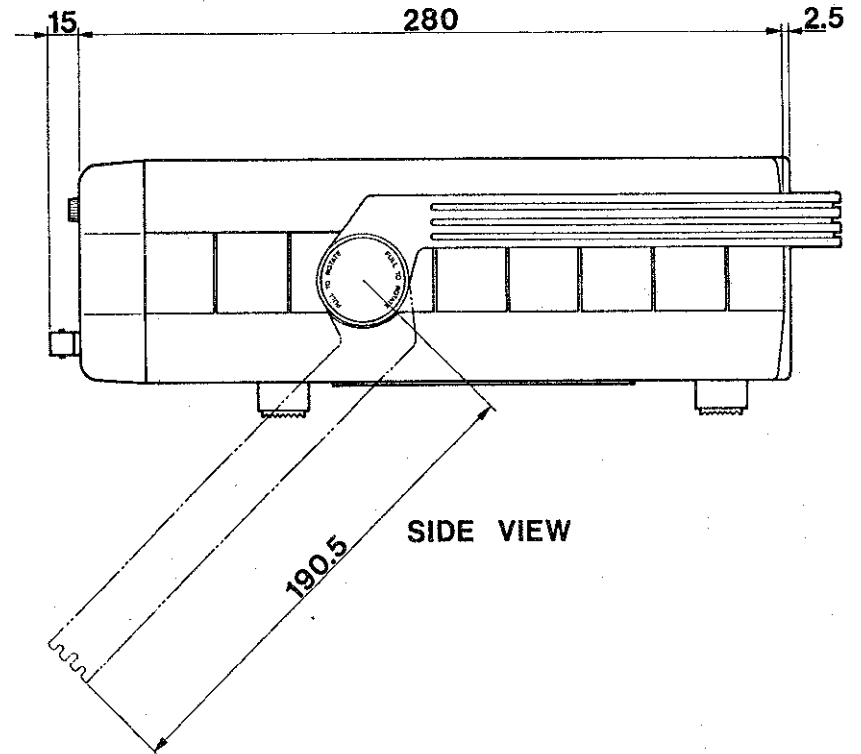

SIDE VIEW

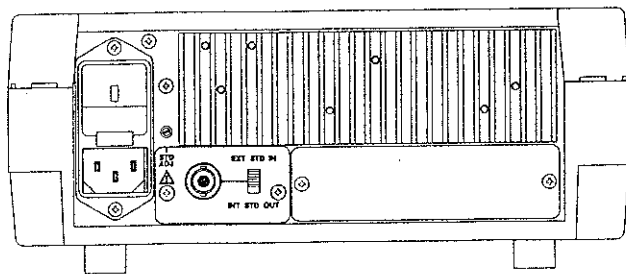

REAR VIEW

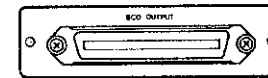

TR5823
EXTERNAL VIEW

Unit: mm

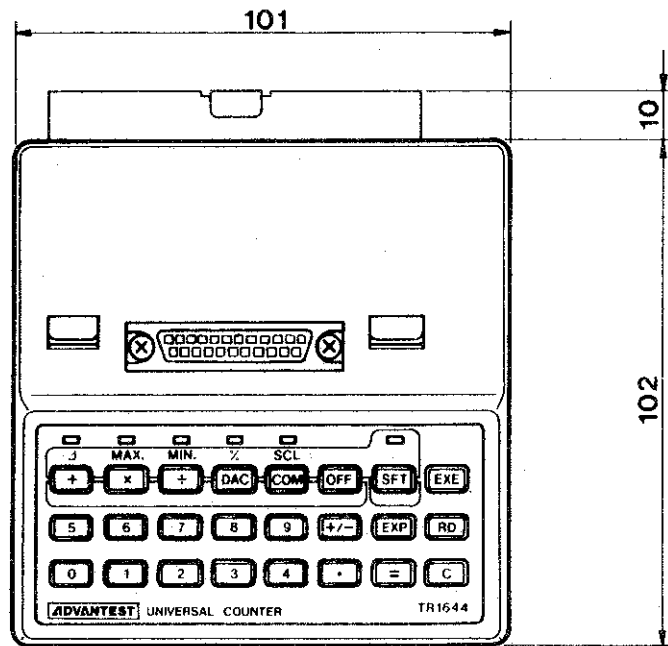

TOP VIEW

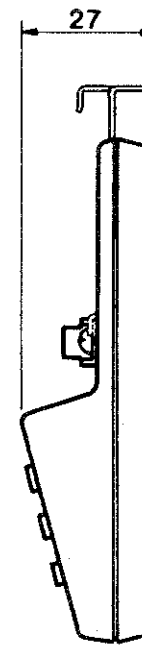

SIDE VIEW

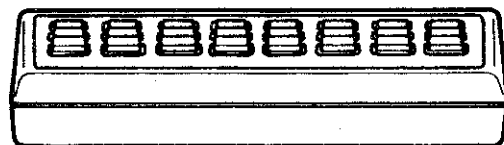

FRONT VIEW

Unit: mm

TR1644
EXTERNAL VIEW

IMPORTANT INFORMATION FOR ADVANTEST SOFTWARE

PLEASE READ CAREFULLY: This is an important notice for the software defined herein. Computer programs including any additions, modifications and updates thereof, operation manuals, and related materials provided by Advantest (hereafter referred to as "SOFTWARE"), included in or used with hardware produced by Advantest (hereafter referred to as "PRODUCTS").

SOFTWARE License

All rights in and to the SOFTWARE (including, but not limited to, copyright) shall be and remain vested in Advantest. Advantest hereby grants you a license to use the SOFTWARE only on or with Advantest PRODUCTS.

Restrictions

- (1) You may not use the SOFTWARE for any purpose other than for the use of the PRODUCTS.
- (2) You may not copy, modify, or change, all or any part of, the SOFTWARE without permission from Advantest.
- (3) You may not reverse engineer, de-compile, or disassemble, all or any part of, the SOFTWARE.

Liability

Advantest shall have no liability (1) for any PRODUCT failures, which may arise out of any misuse (misuse is deemed to be use of the SOFTWARE for purposes other than its intended use) of the SOFTWARE. (2) For any dispute between you and any third party for any reason whatsoever including, but not limited to, infringement of intellectual property rights.

LIMITED WARRANTY

1. Unless otherwise specifically agreed by Seller and Purchaser in writing, Advantest will warrant to the Purchaser that during the Warranty Period this Product (other than consumables included in the Product) will be free from defects in material and workmanship and shall conform to the specifications set forth in this Operation Manual.
2. The warranty period for the Product (the "Warranty Period") will be a period of one year commencing on the delivery date of the Product.
3. If the Product is found to be defective during the Warranty Period, Advantest will, at its option and in its sole and absolute discretion, either (a) repair the defective Product or part or component thereof or (b) replace the defective Product or part or component thereof, in either case at Advantest's sole cost and expense.
4. This limited warranty will not apply to defects or damage to the Product or any part or component thereof resulting from any of the following:
 - (a) any modifications, maintenance or repairs other than modifications, maintenance or repairs (i) performed by Advantest or (ii) specifically recommended or authorized by Advantest and performed in accordance with Advantest's instructions;
 - (b) any improper or inadequate handling, carriage or storage of the Product by the Purchaser or any third party (other than Advantest or its agents);
 - (c) use of the Product under operating conditions or environments different than those specified in the Operation Manual or recommended by Advantest, including, without limitation, (i) instances where the Product has been subjected to physical stress or electrical voltage exceeding the permissible range and (ii) instances where the corrosion of electrical circuits or other deterioration was accelerated by exposure to corrosive gases or dusty environments;
 - (d) use of the Product in connection with software, interfaces, products or parts other than software, interfaces, products or parts supplied or recommended by Advantest;
 - (e) incorporation in the Product of any parts or components (i) provided by Purchaser or (ii) provided by a third party at the request or direction of Purchaser or due to specifications or designs supplied by Purchaser (including, without limitation, any degradation in performance of such parts or components);
 - (f) Advantest's incorporation or use of any specifications or designs supplied by Purchaser;
 - (g) the occurrence of an event of force majeure, including, without limitation, fire, explosion, geological change, storm, flood, earthquake, tidal wave, lightning or act of war; or
 - (h) any negligent act or omission of the Purchaser or any third party other than Advantest.
5. **EXCEPT TO THE EXTENT EXPRESSLY PROVIDED HEREIN, ADVANTEST HEREBY EXPRESSLY DISCLAIMS, AND THE PURCHASER HEREBY WAIVES, ALL WARRANTIES, WHETHER EXPRESS OR IMPLIED, STATUTORY OR OTHERWISE, INCLUDING, WITHOUT LIMITATION, (A) ANY WARRANTY OF MERCHANTABILITY OR FITNESS FOR A PARTICULAR PURPOSE AND (B) ANY WARRANTY OR REPRESENTATION AS TO THE VALIDITY, SCOPE, EFFECTIVENESS OR USEFULNESS OF ANY TECHNOLOGY OR ANY INVENTION.**
6. **THE REMEDY SET FORTH HEREIN SHALL BE THE SOLE AND EXCLUSIVE REMEDY OF THE PURCHASER FOR BREACH OF WARRANTY WITH RESPECT TO THE PRODUCT.**
7. **ADVANTEST WILL NOT HAVE ANY LIABILITY TO THE PURCHASER FOR ANY INDIRECT, INCIDENTAL, SPECIAL, CONSEQUENTIAL OR PUNITIVE DAMAGES, INCLUDING, WITHOUT LIMITATION, LOSS OF ANTICIPATED PROFITS OR REVENUES, IN ANY AND ALL CIRCUMSTANCES, EVEN IF ADVANTEST HAS BEEN ADVISED OF THE POSSIBILITY OF SUCH DAMAGES AND WHETHER ARISING OUT OF BREACH OF CONTRACT, WARRANTY, TORT (INCLUDING, WITHOUT LIMITATION, NEGLIGENCE), STRICT LIABILITY, INDEMNITY, CONTRIBUTION OR OTHERWISE. TORT (INCLUDING, WITHOUT LIMITATION, NEGLIGENCE), STRICT LIABILITY, INDEMNITY, CONTRIBUTION OR OTHERWISE.**
8. **OTHER THAN THE REMEDY FOR THE BREACH OF WARRANTY SET FORTH HEREIN, ADVANTEST SHALL NOT BE LIABLE FOR, AND HEREBY DISCLAIMS TO THE FULLEST EXTENT PERMITTED BY LAW ANY LIABILITY FOR, DAMAGES FOR PRODUCT FAILURE OR DEFECT, WHETHER ARISING OUT OF BREACH OF CONTRACT, TORT (INCLUDING, WITHOUT LIMITATION, NEGLIGENCE), STRICT LIABILITY, INDEMNITY, CONTRIBUTION OR OTHERWISE.**

CUSTOMER SERVICE DESCRIPTION

In order to maintain safe and trouble-free operation of the Product and to prevent the incurrence of unnecessary costs and expenses, Advantest recommends a regular preventive maintenance program under its maintenance agreement.

Advantest's maintenance agreement provides the Purchaser on-site and off-site maintenance, parts, maintenance machinery, regular inspections, and telephone support and will last a maximum of ten years from the date the delivery of the Product. For specific details of the services provided under the maintenance agreement, please contact the nearest Advantest office listed at the end of this Operation Manual or Advantest's sales representatives.

Some of the components and parts of this Product have a limited operating life (such as, electrical and mechanical parts, fan motors, unit power supply, etc.). Accordingly, these components and parts will have to be replaced on a periodic basis. If the operating life of a component or part has expired and such component or part has not been replaced, there is a possibility that the Product will not perform properly. Additionally, if the operating life of a component or part has expired and continued use of such component or part damages the Product, the Product may not be repairable. Please contact the nearest Advantest office listed at the end of this Operation Manual or Advantest's sales representatives to determine the operating life of a specific component or part, as the operating life may vary depending on various factors such as operating condition and usage environment.

SALES & SUPPORT OFFICES

Advantest Korea Co., Ltd.

22BF, Kyobo KangNam Tower,
1303-22, Seocho-Dong, Seocho-Ku, Seoul #137-070, Korea
Phone: +82-2-532-7071
Fax: +82-2-532-7132

Advantest (Suzhou) Co., Ltd.

Shanghai Branch Office:
Bldg. 6D, NO.1188 Gumei Road, Shanghai, China 201102 P.R.C.
Phone: +86-21-6485-2725
Fax: +86-21-6485-2726

Shanghai Branch Office:
406/F, Ying Building, Quantum Plaza, No. 23 Zhi Chun Road,
Hai Dian District, Beijing,
China 100083
Phone: +86-10-8235-3377
Fax: +86-10-8235-6717

Advantest (Singapore) Pte. Ltd.

438A Alexandra Road, #08-03/06
Alexandra Technopark Singapore 119967
Phone: +65-6274-3100
Fax: +65-6274-4055

Advantest America, Inc.

3201 Scott Boulevard, Suite, Santa Clara, CA 95054, U.S.A
Phone: +1-408-988-7700
Fax: +1-408-987-0691

ROHDE & SCHWARZ Europe GmbH

Mühldorfstraße 15 D-81671 München, Germany
(P.O.B. 80 14 60 D-81614 München, Germany)
Phone: +49-89-4129-13711
Fax: +49-89-4129-13723

ADVANTEST®

<http://www.advantest.co.jp>