

AN8008 Digital Multimeter User Manual

Bei „OFF“ **kein** Signal anlegen!!!





A. Introduction

AN8008 is the world's first 9999 counts palm-size auto-ranging digital multimeter. The product is battery-powered with true-rms, LCD display and backlight.

B. Safety Information

To avoid possible electrical shock, fire, or personal injury, please read all safety information before you use the product.

- (1) Do **NOT** exceed the “**maximum value**” indicated in the Specification.
- (2) Examine the connection of the test leads and the insulation of the product before measuring voltage higher than 36V DC or 25V AC.
- (3) Disconnect the test leads from the circuit before changing the mode.
- (4) Misuse of mode or range can lead to hazards, be cautious. “OL” will be shown on the display when the input is out of range.
- (5) Safety symbols:

	Hazardous Voltage		Earth
	Double Insulated		Low Battery
	Risk of Danger. Check the User Manual.		

C. Specifications

Electrical Specifications					
Function	Range	Resolution	Accuracy	MAX. Value	Other
DC Voltage (V)	999.9mV	0.1mV	±(0.5%+3)	999.9V	
	9.999V	0.001V			
	99.99V	0.01V			
	999.9V	0.1V			
DC Voltage (mV)	9.999mV	0.001mV		99.99mV	
	99.99mV	0.01mV			
AC Voltage (V)	999.9mV	0.1mV	±(1.0%+3)	750V	40Hz-1kHz
	9.999V	0.001V			
	99.99V	0.01V			
	750.0V	0.1V			
AC Voltage (mV)	9.999mV	0.001mV		99.99mV	
	99.99mV	0.01mV			
DC Current (mA&A)	999.9mA	0.1mA	±(1.0%+3)	9.999A	
	9.999A	0.001A			
DC Current (µA)	99.99µA	0.01µA	±(0.8%+3)	999.9µA	
	999.9µA	0.1µA			
AC Current (mA&A)	999.9mA	0.1mA	±(1.2%+3)	9.999A	40Hz-1kHz
	9.999A	0.001A			
AC Current (µA)	99.99µA	0.01µA	±(1.0%+3)	999.9µA	
	999.9µA	0.1µA			
Resistance	99.99Ω	0.01Ω	±(1.0%+3)	9.999MΩ	
	999.9Ω	0.1Ω			
	9.999kΩ	0.001kΩ	±(0.5%+3)		
	99.99kΩ	0.01kΩ			
	999.9kΩ	0.1kΩ			
9.999MΩ	0.001MΩ	±(1.5%+3)			

Function	Range	Resolution	Accuracy	MAX. Value	Other
Capacitance	9.999nF	0.001nF	±(5.0%+20)	9.999mF	
	99.99nF	0.01nF			
	999.9nF	0.1nF	±(2.0%+5)		
	9.999μF	0.001μF			
	99.99μF	0.01μF			
		999.9μF	0.1μF		
	9.999mF	0.001mF			
Frequency	99.99Hz	0.01Hz	±(0.1%+2)	9.999MHz	
	999.9Hz	0.1Hz			
	9.999kHz	0.001kHz			
	99.99kHz	0.01kHz			
	999.9kHz	0.1kHz			
	9.999MHz	0.001MHz			
Duty Cycle	1%~99%	0.1%	±(0.1%+2)		
Diode	√				
Continuity	√				
Square Wave Output	50Hz/100Hz/200Hz/300Hz/400Hz/500Hz/600Hz/700Hz/800Hz/900Hz/1000Hz/2000Hz/3000Hz/4000Hz/5000Hz				
General Specifications					
Display (LCD)	9999 Counts				
Ranging	Auto/Manual				
Material	ABS				
Update Rate	3 Times/Second				
Ture RMS	√				
Back Light	√				
Data Hold	√				
Low Battery Indication	√				
Auto Power Off	√				
Mechanical Specifications					
Dimension	130*65*32mm				
Weight	130g (batteries included)				
Battery Type	1.5V AAA Batteries * 2				
Warranty	One year				
Environmental Specifications					
Operating	Temperature	0~40°C			
	Humidity	<75%			
Storage	Temperature	-20~60°C			
	Humidity	<80%			
Safety Specifications					
EN 61010-1:2010; EN 61326-1:2013, FCC Part 15 Subpart B:2016					
Standard Accessories					
Battery * 2pcs; Test Lead * 1 pair; Drawstring Pouch * 1pc; English User Manual; Gift Box					

D. Instruction

(1) Front Panel (see the picture on the right)

1. LCD display
2. Buttons
 - 2a. RANGE/Backlight: press this button to enter the manual range; each push increases the range; when the highest range is reached, next push will go back to the lowest range; to exit the manual range mode, turn the Rotary Switch to another mode and then turn it back. To turn on the backlight, press this button for more than 2 seconds; long-press again to turn off.
 - 2b. SELECT/HOLD: To toggle between different testing modes (functions), press this button. To hold the current reading, press this button for more than 2 seconds and you will see "HOLD" on the display; long-press again to turn off.
3. Rotary Switch: To change mode or range. (from OFF, clockwise)
 - 3a. OFF
 - 3b. DC Voltage (V)/AC Voltage (V)/Frequency (high voltage low frequency)/Duty Cycle
 - 3c. DC Voltage (mV)/AC Voltage (mV)
 - 3d. Resistance/Continuity/Diode/Capacitance
 - 3e. Frequency (low voltage high frequency)/Duty Cycle
 - 3f. DC Current (mA&A)/AC Current (mA&A)
 - 3g. DC Current (μA)/AC Current (μA)
 - 3h. Square Wave Output
4. mA: Input terminal for current (mA&A) measurements.
5. COM: Common terminal for all measurements.
6. VΩHz: Input terminal for voltage, current (μA), frequency, duty cycle, resistance, continuity, diode, capacitance measurements. Outout terminal for square wave.

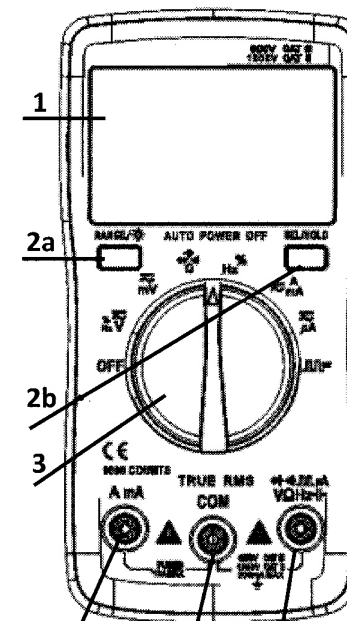

(2) Measure AC/DC Voltage

1. Connect the black test lead to the COM Terminal and connect the red test lead to the VΩHz Terminal;
2. Turn the rotary switch to the DC Voltage (V) Mode, or the DC Voltage (mV) Mode;
3. Press SELECT to toggle between AC/DC;
4. Touch the probes to the correct test points of the circuit to measure the voltage;
5. Read the measured voltage on the display.

*Caution:

- a. Do not measure voltage that exceeds the MAX Value as indicated in the Specifications;
- b. Do not touch high voltage circuit during measurements.

(3) Measure AC/DC Current (mA&A)

1. Connect the black test lead to the COM Terminal and connect the red test lead to the AmA Terminal;
2. Turn the rotary switch to the DC Current (mA&A) Mode;
3. Press SELECT to toggle between AC/DC;
4. Break the circuit path to be measured. Then connect the test leads across the break and apply power;
5. Read the measured current on the display.

*Caution:

- a. Do not measure current that exceeds the MAX Value as indicated in the Specifications;
- b. Use the AmA Terminal and the DC Current (mA&A) Mode when you are measuring an unknown current. Then switch to the Terminal and the Mode if necessary.

(4) Measure AC/DC Current (mA&A)

1. Connect the black test lead to the COM Terminal and connect the red test lead to the VΩHz Terminal;
2. Turn the rotary switch to the DC Current (μA) Mode;
3. Press SELECT to toggle between AC/DC;
4. Break the circuit path to be measured. Then connect the test leads across the break and apply power;
5. Read the measured current on the display.

*Caution:

- a. Do not measure current that exceeds the MAX Value as indicated in the Specifications;
- b. Use the AmA Terminal and the DC Current (mA&A) Mode when you are measuring an unknown current. Then switch to the Terminal and the Mode if necessary.

Do not input voltage exceeds 36V DC or 25V AC when you are at the setting of measuring current.

(5) Measure Resistance

1. Connect the black test lead to the COM Terminal and connect the red test lead to the VΩHz Terminal;
2. Turn the rotary switch to the Resistance Mode, and the display will show "OL";
3. Touch the probes to the desired test points of the circuit to measure the resistance;
4. Read the measured resistance on the display.

*Caution:

- a. Disconnect circuit power and discharge all capacitors before you test resistance.
- b. Do not input voltage at the Resistance Mode.

(6) Measure Continuity

1. Connect the black test lead to the COM Terminal and connect the red test lead to the VΩHz Terminal;
2. Turn the rotary switch to the Resistance Mode, press SELECT once to toggle to the Continuity Mode;
3. Touch the probes to the desired test points of the circuit;
4. The built-in beeper will beep when the resistance is lower than 50Ω, which indicates a short circuit.

*Caution:

- a. Do not input voltage at the Continuity Mode.

(7) Measure Diode

1. Connect the black test lead to the COM Terminal and connect the red test lead to the VΩHz Terminal;
2. Turn the rotary switch to the Resistance Mode, press SELECT twice to toggle to the Diode Mode;
3. Connect the red probe to the anode side and the black probe to the cathode side of the diode being tested;
4. Read the forward bias voltage value on the display;
5. If the polarity of the test leads is reversed with diode polarity or the diode is broken, the display reading shows "OL".

*Caution:

- a. Do not input voltage at the Diode Mode.
- b. Disconnect circuit power and discharge all capacitors before you test diode.

(8) Measure Capacitance

1. Connect the black test lead to the COM Terminal and connect the red test lead to the VΩHz Terminal;
2. Turn the rotary switch to the Resistance Mode, press SELECT three times to toggle to the Capacitance Mode;
3. Connect the red probe to the anode side and the black probe to the cathode side of the capacitor being tested;
4. Read the measured capacitance value on the display once the reading is stabilized.

*Caution:

- a. Disconnect circuit power and discharge all capacitors before you test capacitance.

(9) Measure Frequency and Duty Cycle

1. Connect the black test lead to the COM Terminal and connect the red test lead to the VΩHz Terminal;
2. To measure high voltage low frequency, turn the rotary switch to the DC Voltage(V) Mode; press SELECT twice to toggle to the Frequency Mode or press SELECT three times to toggle to the Duty Cycle Mode. To measure low voltage high frequency, turn the rotary switch to the Frequency Mode; press SELECT once to toggle to the Duty Cycle Mode;
3. Touch the probes to the desired test points of the circuit;
4. Read the measured frequency/duty cycle value on the display.

(10) Square Wave Output

1. Connect the black test lead to the COM Terminal and connect the red test lead to the VΩHz Terminal;;
2. Turn the rotary switch to the Square Wave Output Mode, and the default output frequency is 50Hz, to change the output frequency, press the SELECT botton;
3. Touch the probes to the desired test points.

*Caution:

- a. Do not input voltage at the Square Wave Output Mode.

(11) Auto Power Off

1. The product automatically powers off after 15 minutes of inactivity;
2. The built-in beeper beeps 5 times 1 minute before power off;
3. To restart the product, press SELECT botton;
4. To disable the Auto Power Off function, hold down the SELECT botton when turning on the product, you will hear five beeps if you have successfully disabled the function.

E. General Maintenance

Beyond replacing batteries and fuses, do not attempt to repair or service the product unless you are qualified to do so and have the relevant calibration, performance test, and service instructions.

- (1) Do not operate the product around hot, wet, flammable, explosive or magnetic environments.
- (2) Clean the product with damp cloth and mild detergent; do not use abrasives or solvents.
- (3) Remove the input signals before you clean the product.
- (4) Remove the batteries if you will not use the product for a long time to prevent possible battery leak.
- (5) When "  is shown on the display, batteries shall be replaced as below:
 1. Loosen the screw and remove the battery cover;
 2. Replace the used batteries with new batteries of the same type;
 3. Place the battery cover back and fasten the screw.
- (6) Replace fuses as above steps. Use only fuses of the same type as the original ones.

Warning:

1. Do NOT exceed the "maximum value" indicated in the Specification;
2. Do NOT input voltage at the Current Mode, the Resistance Mode, the Diode Mode, the Continuity Mode, or the Temperature Mode;
3. Do NOT use the product when the batteries or the battery cover is not placed properly;
4. Turn off the product and remove the test leads from the test points before changing batteries or fuses.

F. Troubleshooting

If your product do not function as normal, the following steps may help you. If the problem still cannot be solved, please contact your dealer.

Problem	Possible Reason
Display Mulfunction	Low battery; replace batteries
 Symbol	Replace batteries
No current input	Replace fuse

LIMITED WARRANTY AND LIMITATION OF LIABILITY

Customers enjoy one-year warranty from the date of purchase. This warranty does not cover fuses, disposable batteries, or damage from accident, neglect, misuse, alternation, contamination, or abnormal conditions of operation or handling.

All rights reserved. Specifications are subject to change without notice.