

ELECTRONIC MEASURING INSTRUMENTS

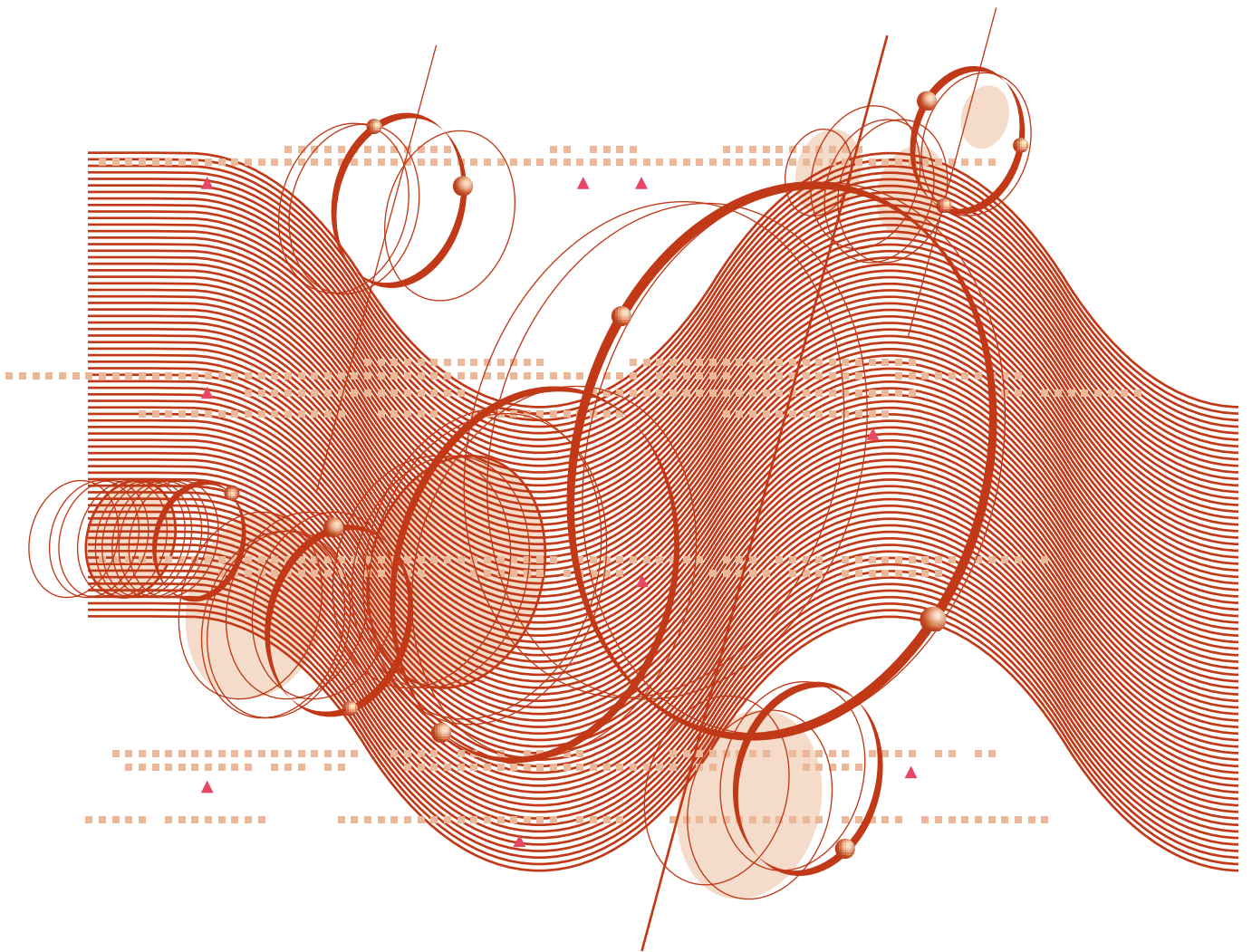

**RF and Microwave/General Purpose Test
Product Catalog 2005**

Contents

Outline of Anritsu Corporation	2
Web Site Information	3
Market Focused Catalogs	4
Sales, Shipping, and Service Information	5
Sales Network	6

RF and Microwave/General Purpose Test

New Products	10	
MG3690B Series	RF/Microwave Signal Generator	15
MG3633A	Synthesized Signal Generator	17
MG3641A	Synthesized Signal Generator	19
MG3642A	Synthesized Signal Generator	19
MG3700A	Vector Signal Generator	21
MS2781A	Signature™ High Performance Signal Analyzer	23
MS2661C	Spectrum Analyzer	25
MS2663C	Spectrum Analyzer	26
MS2665C	Spectrum Analyzer	27
MS2667C	Spectrum Analyzer	29
MS2668C	Spectrum Analyzer	31
MS2681A	Spectrum Analyzer	33
MS2683A	Spectrum Analyzer	33
MS2687B	Spectrum Analyzer	33
MS2721A	Spectrum Master	34
ML2480A Series	Wideband Peak Power Meters	36
ML2400A Series	Power Meters	38
ML2430A Series	Power Meters	38
ME7808B	Broadband and Millimeter Wave Vector Network Analyzer	41
37000D Series	Microwave Vector Network Analyzers	42
37000D Series	Microwave Multi-Port Balanced Vector Network Analyzer	44
MS4622A/B/D	Vector Network Measurement Systems (VNMS)	46
MS4623A/B/D	Vector Network Measurement Systems (VNMS)	46
MS4624A/B/D	Vector Network Measurement Systems (VNMS)	46
MS4622C	Vector Network Measurement System/Direct-Access Receiver	48
MS4623C	Vector Network Measurement System/Direct-Access Receiver	48
MS4624C	Vector Network Measurement System/Direct-Access Receiver	48
ME7840A	Power Amplifier Test System (PATS)	49
ME7842B	Tower Mounted Amplifier Test System (TMATS)	51
MS4624D Series	RF Multi-Port Balanced Vector Network Analyzer	53
MS4622B Series	PIM-S System (VNA and Passive Intermodulation Test System)	54
MS4630B	Network Analyzer	56
36584 Series	4 Port Vector Network Analyzer Automatic Calibrator	58
3658 Series	Vector Network Analyzer Automatic Calibrator	59
MN4765A	O/E Calibration Module	60
Calibration Kits	VNA and VNMS	61
Verification Kits	VNA and VNMS	63
MF2400B Series	Microwave Frequency Counter	64
ML2530A	Calibration Receiver	65
54100A	Scalar Network Analyzer	66
56100A	Scalar Network Analyzer	69
MG442A	Synthesized Level Generator	69
MG443B	Synthesizer/Level Generator	69
MG724E1/G1	Signal Generator	70
MN63A/65A/72A/64B	Programmable Attenuators	70
Quality, Reliability Assurance System and Environmental Considerations		71

Anritsu Corporation's predecessor, Anritsu Electric Co. Ltd., was created by the 1931 merger of Kyoritsu Denki, which grew out of Sekisansha Co., founded in 1895 as a manufacturer of wire communication equipment, and Annaka Denki Seisakusho, established in 1900 as a pioneer in wireless communication equipment. The company name was changed to Anritsu Corporation in 1985 to reflect the firm's status as an international enterprise.

With a history in wire and wireless communications equipment, Anritsu has contributed to the enhancement of society through its numerous products, which include equipment for "original and high-level" communication equipment, instrumentation and control equipment, information terminals, and manufacturing equipment. In particular, Anritsu has grown to be recognized as a world leader in measurement systems for wireless communications as well as optical and super high-speed digital communications. Customers in well over 100 countries use Anritsu products in a diverse range of industrial areas.

To ensure that Anritsu products are of the highest quality, the Anritsu Group is establishing a quality system conforming to international standards, and has become registered as an ISO9001 quality assurance corporation by JQA.

Established March 17, 1931
 Paid-up capital ¥14,043,000,000
 Employees 3,568 (worldwide)

Head Office

1800 Onna, Atsugi-shi, Kanagawa, 243-8555, Japan
 Phone: +81-46-223-1111
 Fax: +81-46-296-1264

See page 6 for sales network.

ANRITSU COMPANY

490 Jarvis Drive, Morgan Hill, CA 95037-2809, U.S.A.
 Phone: +1-408-778-2000
 Fax: +1-408-776-1744

ANRITSU LTD.

200 Capability Green, Luton, Bedfordshire, LU1 3LU, United Kingdom
 Phone: +44-1582-433200
 Fax: +44-1582-731303

Meanwhile, Anritsu head office and Tohoku Anritsu Corporation have earned ISO14001 environmental management certification, demonstrating our dedication to preserving the natural environment.

It is now apparent that the focus of Anritsu's attention, the mobile and Internet areas, are about to evolve even further. In addition to broadband and IP, the entrance of digital broadcasting and intelligent home appliances, mean the arrival of an ubiquitous network society where people are able to communicate anytime, anywhere, with everything as seamless connection between networks developed.

In order to be both the best partner for our customers and to continue to evolve, Anritsu is putting the "original and high-level" technology and intelligence coming from our 100-year history toward this ubiquitous network society. We have transformed ourselves into an "Intelligent Solution Creator." By providing electronic, information communication and measurement solutions that directly contribute to the success of our customers' businesses, Anritsu is supporting the evolution of a ubiquitous network society.

Head Office



ANRITSU COMPANY, U.S.



ANRITSU LTD.



For the latest product updates visit www.anritsu.com

Anritsu Discover What's Possible™

HOME | About Anritsu | Investor Relations | News & Events | Products | Showroom | Contact Us

Ubiquitous Network Solutions

> Go To Solution Showroom

New Products

MD1230A Family Offering powerful network testing, monitoring for 10 Gigabit Ethernet.
 >> more...

Radio Communication Analyzers
 For enhanced throughput and space efficiency in mobile phone manufacturing.
 >> more...

Anritsu World Wide Web Site

Japan	Asia Pacific
Japan (Japanese)	Chinese (Simplified)
Americas	Chinese (Traditional)
Europe	Korea

Anritsu Industrial Solutions Co., Ltd.
 Anritsu Devices Co., Ltd.

News

Apr.1, 2005
 The global site of Anritsu renewed !!
Feb.1, 2005 (Japan)
 The Anritsu group in Japan becomes a vacation between until May 8 from Apr. 29.

Press Release
Jan.11, 2005 (Japan)
 MD1230B Data Quality Analyzer, MUJ20121A 10/100/1000M Ethernet Module, MUJ20122A Gigabit Ethernet Module

Events
Feb. 2-4, 2005 (Japan)
 NET & COM 2005

Keep up to date on the latest product specifications, literature and Anritsu news on www.anritsu.com. Access Anritsu's regional websites to see local events, training and upcoming conferences.

Anritsu Discover What's Possible™

HOME | About Anritsu | Investor Relations | News & Events | Products | Showroom | Contact Us

Products

Test and Measurement
 Wireless
 RF and Microwave
 Data Communications
 Optical

Components and Devices
 Precision RF and Microwave Components
 High Speed Devices
 Optical Devices

Industrial Automation

Data Communications
Select Your Region

- > Americas
- > Europe
- > Japan
- > Asia Pacific
- > Chinese(Simplified)
- > Chinese(Traditional)
- > Korea

Anritsu Discover What's Possible™

HOME | About Anritsu | Investor Relations | News & Events | Products | Showroom | Contact Us

Products

Test and Measurement
 Wireless
 RF and Microwave
 Data Communications
 Optical

Components and Devices
 Precision RF and Microwave Components
 High Speed Devices
 Optical Devices

Industrial Automation

Optical
Select Your Region

- > Americas
- > Europe
- > Japan
- > Asia Pacific
- > Chinese(Simplified)
- > Chinese(Traditional)
- > Korea

Anritsu Discover What's Possible™

HOME | About Anritsu | Investor Relations | News & Events | Products | Showroom | Contact Us

Products

Test and Measurement
 Wireless
 RF and Microwave
 Data Communications
 Optical

Components and Devices
 Precision RF and Microwave Components
 High Speed Devices
 Optical Devices

Industrial Automation

RF and Microwave
Select Your Region

- > Americas
- > Europe
- > Japan
- > Asia Pacific
- > Chinese(Simplified)
- > Chinese(Traditional)
- > Korea

Anritsu Discover What's Possible™

HOME | About Anritsu | Investor Relations | News & Events | Products | Showroom | Contact Us

Products

Test and Measurement
 Wireless
 RF and Microwave
 Data Communications
 Optical

Components and Devices
 Precision RF and Microwave Components
 High Speed Devices
 Optical Devices

Industrial Automation

Wireless
Select Your Region

- > Americas
- > Europe
- > Japan
- > Asia Pacific
- > Chinese(Simplified)
- > Chinese(Traditional)
- > Korea

Below is a list of other Anritsu Electronic Measuring Instruments Catalogs you can order by filling out the inserted Business Reply Card or visiting www.us.anritsu.com/emicalog

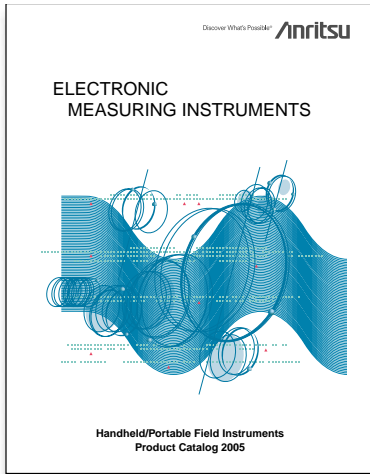

Handheld/Portable Field Instruments

- Access Master OTDR for FTTx test
- WCDMA Area Tester
- Cell Master Base Station Analyzer
- Handheld Spectrum Analyzers
- Network Data Analyzer
- Wideband Peak Power Meter
- Optical time domain Reflectometer
- Optical Loss Test Set
- OTDR, Optical Handy Power Meter
- Power Meters
- Site Master Cable and Antenna Analyzers

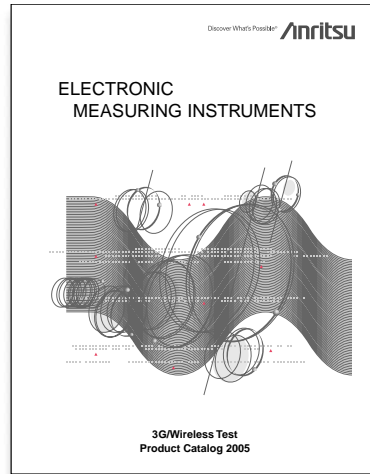

3G/Wireless Test

- WCDMA TRX/Performance Test System
- Digital Modulation Signal Generator
- WCDMA Signaling Tester
- Signaling Tester
- WCDMA Rapid Test Designer (RTD)
- WCDMA Protocol Test System (PTS)
- WCDMA Virtual Signaling Tester (VST)
- Digital Mobile Radio Transmitter Tester
- WLAN Test Set
- Radio Communication Analyzer
- Bluetooth™ Test Set
- Bluetooth™ Prequalification Test System (PQTS)
- WCDMA Area Tester
- Spectrum Analyzer
- Bit Error Rate Tester
- Signature™ High Performance Signal Analyzer
- 3GPP Protocol Analyzer

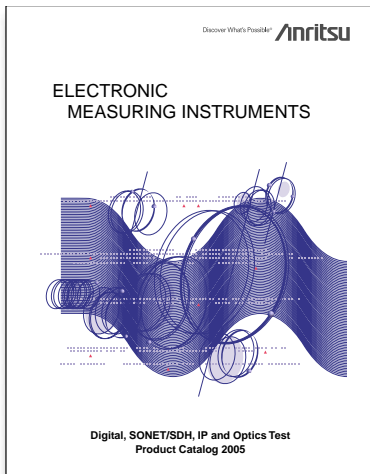

Digital, SONET/SDH, IP and Optics Test

- Multiple test instruments including:
- Bit Error Rate Testers
 - Optical Test Instruments
 - SONET/SDH and
 - Internal Protocol Testers

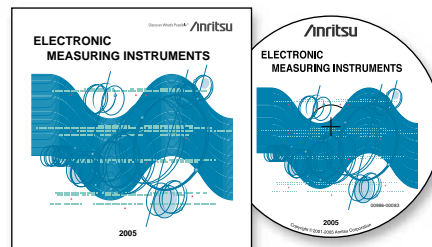

2005 Anritsu EMI Catalog CD ROM

Visit www.us.anritsu.com/emicalog to download the full version of the 2005 Electronic Measuring Instruments Catalog in PDF format, or to order the catalog on CD ROM.

Order by model number

When ordering, please specify the model number and name of the instrument desired, for example, "MP1570A SONET/SDH/PDH/ATM Analyzer." To ensure accuracy, please include all necessary specifications and provide specific instructions in your order; include special options, features, nonstandard power line voltage, etc. To expedite your order we suggest that you contact us directly.

Shipment

Generally, instruments will be shipped within two months of receipt of your order. In the case of "Custom-made products" mentioned in the footnotes, shipment may take from 4 to 7 months. Every endeavor will be made to maintain delivery dates, but no liability is accepted for loss, damage, or delay of instruments, for reasons which are out of our control.

Terms

Unless previous terms have been arranged, we will use one of the following:

- Full payment in advance of shipment
- Sight draft against an irrevocable confirmed letter of credit

Quotations and pro forma invoices

FOB, CIF, C&F, etc., quotations, and pro forma invoices are available upon request. The instrument price includes a packing charge.

Inspection surcharge

An inspection surcharge is applied to all orders requiring inspection by government agencies or individually appointed inspectors at our factory.

Special products made-to-order

Requests for remodeling standard products for special use will be accepted, but only after detailed discussions.

Returning instrument for repairs

When returning an instrument to Anritsu for repairs, the following suggestions will help us return it back to you in the shortest possible time:

- Send complete instructions about what you would like done to the instrument.
- If possible, include the "symptoms" or "defects."
- Indicate the return address along with the address to be used for billing purposes.

Extended warranty service

Extended Warranty Services, Option ES, provide extension of the normal product warranty and may be purchased for many Anritsu products. These services may include repair and/or routine calibration and may be available for delivery on-site or on a return to Anritsu Service Center basis. Consult your local Anritsu Sales Office or Sales Representative for price and availability.

MS-DOS is a registered trademark of Microsoft Corporation.
Windows is a registered trademark of Microsoft Corporation.
APC-3.5 is a registered trademark of Amphenol North America, a division of Bunker Ramo Corporation.
K Connector and V Connector are registered trademarks of Anritsu Company.
LabWindows and LabVIEW are registered trademarks of National Instruments.
LRL/LRM-Calibration method of Rhode & Schwartz, Germany
Bluetooth and the Bluetooth logos are trademarks owned by the Bluetooth SIG, Inc., U.S.A. and licensed to the Anritsu Corporation.
cdma2000® is a registered trademark of the Telecommunications Industry Association (TIA –USA).

WARRANTY

All other expressed warranties are disclaimed and all implied warranties for this product, including the warranties of merchantability and fitness for a particular purpose, are limited in duration to a period of one year from the date of delivery. In no event shall all Anritsu group be liable to the customer for any damages, including lost profits, or other incidental or consequential damages arising out of the use or inability to use this product.

• Argentina

MULTIRADIO S.A.

Av. Cordoba, 4860 Buenos Aires
C1414BAT, Argentina
TEL: +5411-4779-5555
FAX: +5411-4779-5510

• Australia

ANRITSU PTY LTD

Unit 3/170 Forster Road
Mount. Waverley, Vic., 3149
Australia
TEL: +61-3-9558-8177
FAX: +61-3-9558-8255

• Austria

WIEN-SCHALL GmbH

Krichbaumgasse 25
A-1120 Vienna, Austria
TEL: +43-1-81155140
FAX: +43-1-81155180

ELSINCO GmbH

(HEADQUARTERS)
Breitenfurter Strasse 13
A-1120 Vienna, Austria
TEL: +43 (0)1 815 04 00
FAX: +43 (0)1 815 07 00

• Bahrain

BASMATECH

P. O. Box 5701, Manama, Bahrain
TEL: +973-273729
FAX: +973-725404

• Belgium

ANRITSU GmbH

Grafenberger Allee 54-56, 40237
Düsseldorf, Germany
TEL: +49-211-96855-0
FAX: +49-211-96855-55

• Brazil

ANRITSU ELETRÔNICA LTDA.

Praça Amadeu Amaral 27, 1 Andar
Bela Vista CEP 01327-010
São Paulo - SP, Brazil
TEL: +55-11-3283-2511
FAX: +55-11-3288-6940

ANRITSU ELETRÔNICA LTDA.

Rua Voluntarios da Patria, 45 13 Andar
Botafogo CEP 22270-000, Rio de Janeiro, RJ
TEL: +55-21-2527-6922
FAX: +55-21-2537-1456

• Bulgaria

ELCO STAR COM

49, Zlatovrah
BG-1164 Sofia, Bulgaria
TEL: +359-2-962-8545
FAX: +359-2-962-8546

• Canada

ANRITSU ELECTRONICS LTD

700 Silver Seven Road, Suite 120, Kanata
ON K2V 1C3, Canada
TEL: +1-613-591-2003
FAX: +1-613-591-1006

ANRITSU ELECTRONICS LTD

(TORONTO OFFICE)
2810 Matheson Blvd. E, 2nd Fl.
Mississauga, ON L4W 4X7, Canada
TEL: +1-877-267-4878
TEL: +1-905-890-7799
FAX: +1-905-625-5864

ANRITSU ELECTRONICS LTD

(VANCOUVER OFFICE)
300-1055 W Hastings St.
Vancouver, BC V6E 2E9 Canada
TEL: +1-877-267-4878
TEL: +1-604-682-5933
FAX: +1-604-682-5934

• Chile

SISTEMAS DE INSTRUMENTACION LTDA.

Concha y Toro 65, Stgo Centro
Santiago, Chile 51880
TEL: +56-2-6960031
FAX: +56-2-6969665

• China

ANRITSU COMPANY LTD

(HONG KONG OFFICE)
Suite 923, 9/F, Chinachem Golden
Plaza, 77 Mody Road, Tsimshatsui East,
Kowloon, Hong Kong
TEL: +852-2301 4980
FAX: +852-2301 3545

ANRITSU COMPANY LTD

(BEIJING OFFICE)
Room 1515, Beijing Fortune Building
No.5, North Road, the East 3rd Ring Road
Chao Yang District, 100004
TEL: 010-6590 9230
FAX: 010-6590 9235

ANRITSU COMPANY LTD

(XI' AN OFFICE)
NO.1102, Zhi Cheng Building, No.2
Gao Xin I Road, High-Tech Development
Zone, Xi' an 710075
TEL: 029-8377 406/9
FAX: 029-8377 410

ANRITSU COMPANY LTD

(WUHAN OFFICE)
A1803, Zhong Shang Plaza, No.7
Zhongnan Road, Wuchang, Wuhan 430071
TEL: 027-8771 3355
FAX: 027-8732 2773

ANRITSU COMPANY LTD

(SHENYANG OFFICE)
2-185, City Plaza, No.206, Nanjing
North Street, He Ping District
Shenyang 110001
TEL: 024-2334 1178/89
FAX: 024-2334 2838

ANRITSU COMPANY LTD

(SHANGHAI OFFICES)
A1807-1810 City Center, Zun Yi Road
Shanghai 200051
TEL: 021-6237-0898
FAX: 021-6237-0899

ANRITSU ELECTRONICS CO. LTD

2F, Rm.B, 52 Section Factory Bldg.
No. 516 Fu Te Rd. (N), Shanghai Pudong
Weigaoqiao Free Trade Zone
Shanghai 200131, P.R. of China
TEL: (021) 5868-0228
FAX: (021) 5868-0588

ANRITSU COMPANY LTD

(GUANGZHOU OFFICE)
Room 3008-9, Dongshan Plaza
No.69 Xian Lie Central Road
Guangzhou 510095
TEL: 020-8732 2231/2
FAX: 020-8732 2230

ANRITSU COMPANY LTD

(CHENGDU OFFICE)
26E New Times Square,
No.42, Wen Wu Road, Xinhua Street
Chengdu 610017
TEL: 028-8651 0011/22/33
FAX: 028-8651 0055

ANRITSU COMPANY LTD

(CHONG QING OFFICE)
U9, No.3, Marriott Hotel, Office Tower
No.77, Youth Road, Central District
Chongqing 400010
TEL: 023-6383 0218
FAX: 023-6383 0238

ANRITSU COMPANY LTD

(SHENZHEN OFFICE)
Room 1505, Building A, World Trade Plaza
Fuhong Road, Shenzhen 518033
TEL: 0755-8366 2847/2851/2852
FAX: 0755-8366 2849

• Costa Rica

SONIVISION, S.A.

P.O. Box 620-1000, San Jose, Costa Rica
TEL: +506-231-5685
FAX: +506-231-6531

• Croatia

ELSINCO REPRESENTATION OFFICE

ZAGREB
Savska 66 HR-10000 Zagreb, Croatia
TEL: +385 (0)1-631 2477
FAX: +385 (0)1-631 2488

• Cyprus

CHRIS RADIOVISION LTD

23 Crete Street, T.T. 1061
P. O. Box 21989, 1515 Nicosia, Cyprus
TEL: +357-22766121
FAX: +357-22765177

• Czech Republic

ELSINCO CZ S.R.O.

Novodvorská 994, CZ-142 21 Praha 4
Czech Republic
TEL: +420-241 001 251
FAX: +420-241 001 259

ELSINCO CZ S.R.O.

(BRNO BRANCH OFFICE)
Strmá 19, Czech Republic, CZ-616 00 Brno
TEL: +420-541 427 211
FAX: +420-541 427 219

• Denmark

ANRITSU AB DANMARK

Korskildelund 6
DK - 2670 Greve, Denmark
TEL: +45-36915035
FAX: +45-43909371

• Ecuador

EQUITRONICS S.A.

Belgica N32 H y Av. de Los Shyris
Edificio Ivsemon Park, Suite 4B
Quito, Ecuador
TEL: +593-2-2255-396
FAX: +593-2-2255-396

• Egypt

GIZA SYSTEMS ENGINEERING S.A.E.

17 Tiba Street, Mohandisseen, Giza, Egypt
TEL: +202-7608801
FAX: +202-3385775/3385799

• Finland

ANRITSU AB

Teknobulevardi 3-5, FI-01530
Vantaa, Finland
TEL: +358-9-435-522-0
FAX: +358-9-435-522-50

• France

ANRITSU S.A.

9, Avenue du Québec Z.A. de Courtaboeuf
91951 Les Ulis Cedex, France
TEL: +33-1-60-92-15-50
FAX: +33-1-64-46-10-65

• Germany

ANRITSU GmbH

Grafenberger Allee 54-56
D-40237 Dusseldorf, Germany
TEL: +49-211-96855-0
FAX: +49-211-96855-55

• Greece

KOSTAS KARAYANNIS SA

76, Lavriou str.
Nea Ionia GR 142 35
Athens, Greece
TEL: +30-210-2770800
FAX: +30-210-2719800

• Guatemala

IMPELSA

4a Calle 1-15 Zona 10
Guatemala, CP 01010
TEL: +502-362-5135
FAX: +502-362-6260

• Hungary

ELSINCO BUDAPEST K.F.T.

Pannónia utca 8. IV/l., H-1136 Budapest
Hungary
TEL: +36 (0)1 339 00 00
FAX: +36 (0)1 339 44 44

• India

M/S MERRA AGENCIES PVT. LTD

23 Community Centre, Zamroodpur
Kailash Colony Extension,
New Delhi - 110 048, India
TEL: +91-11-26442700
FAX: +91-11-26442500
(For Handheld Products only)

• Indonesia

PT. SUBUR SAKTI PUTERA

Jalan Tanah Abang III No. 15
Jakarta 10044 Indonesia
TEL: +62-21-352-4821
FAX: +62-21-352 4831

• Ireland

PEMA LTD

Ardee Enterprise Centre
Ardee, Co. Louth.
Ireland
TEL: +353 (0) 41-685-7870
FAX: +353 (0) 41-685-7875

• Israel

TECH-CENT LTD

P. O. Box 43259 (Mailing Address)
12 Raul Valenberg St. (Street Address)
Tel-Aviv, 61430
Israel
TEL: +972-03 6478563
FAX: +972-03 6478334

• Italy

ANRITSU S.P.A.

Via Elio Vittorini
129, 00144 Roma EUR, Italy
TEL: +39-06-509-9711
FAX: +39-06-502-2425

ANRITSU S.P.A.

(MILANO OFFICE)
C.D. Colleoni, Via Paracelso, 4 20041
AGRATE B.ZA (MI), Italy
TEL: +39-039- 657021
FAX: +39-039-6056396

• Japan

ANRITSU CORPORATION

1800 Onna, Atsugi-shi, Kanagawa
243-8555, Japan
TEL: +81-46-223-1111
FAX: +81-46-296-1264

• Korea

ANRITSU CORPORATION LTD

8F Hyunjuk-Bldg, 832-41,
Yeoksam-Dong, Kangnam-Ku
Seoul, 135-080, Korea
TEL: +82-2-553-6603
FAX: +82-2-553-6604, 6605

• Kuwait

TAREQ COMPANY

P.O. Box 20506 Safat, 13066 Safat, Kuwait
TEL: +965-243-6100
FAX: +965-243-7700

• Luxembourg

ANRITSU GmbH

Grafenberger Allee 54-56
D-40237 Dusseldorf
TEL: +49-211-96855-0
FAX: +49-211-96855-55

• Malaysia

O'CONNOR'S ENGINEERING SDN BHD

Bangunan O'Connor, Lot 13 Jalan 223
46100 Petaling Jaya, Selangor D.E
P.O. Box 8795, 46798 Kelana Jaya
Selangor Darul Ehsan, Malaysia
TEL: 603-79538400
FAX: 603-79577871

• Mexico

SHIKATRONICS MMWAVE S.A. DE C.V.

Luz Savinon # 9, Sexto Piso
Colonia del Valle
Mexico DF
CP 03100
TEL: +5255-9171-9500
FAX: +5255-9171-9515

• Morocco

SEDEL

24, 26, Bd, Resistance, Casablanca
Morocco
TEL: +212-2-302444
FAX: +212-2-449311

• Nepal

BR INTERNATIONAL PVT. LTD

P. O. Box 60, Tamrakar Comm. Bldg.
Bhotebahal Kathmandu, Nepal
TEL: +977-1-224-706
FAX: +977-1-227-956

• Netherlands

ANRITSU GmbH

Grafenberger Allee 54-56, 40237
Düsseldorf, Germany
TEL: +49-211-96855-0
FAX: +49-211-96855-55

• New Zealand

ELECTROTEST LTD

PO Box 300 475
Albany, Auckland
New Zealand
TEL: +64-9-448-2600
FAX: +64-9-448-2611

• Nigeria

TELNET NETWORK SERVICES

Plot 242 Kofo Abayomi Street
Victoria Island,
P.O. Box 53656, Ikoyi
Lagos, Nigeria
TEL: +234-1-2611729
FAX: +234-1-2619945

• Norway

BLOMKVIST AS

Veslefrikksvai 11
Pb 188 1371 ASKR, Norway
TEL: +47-66-901190
FAX: +47-66-901212

• Oman

NATIONAL PROJECTS AND TECHNOLOGY COMPANY L.L.C

P. O. Box 97, Wadi Al Kabi
Postal Code 117, Sultanate of Oman
TEL: +968-793741
FAX: +968-796158

• Pakistan

AETCO

Zia Chambers, 25-Mcleod road
Lahore 54000, Pakistan
TEL: +92-42-7311035
FAX: +92-42-7221456

SUPERIOR ELECTRONICS ASSOCIATED

B-98 Block H, North Nasimabad
Karachi-33, Pakistan
TEL: +92-21-613655

- Paraguay

DATALAB S.R.L.

Avda. Artigas No 1645 Edificio "DataLab"
Asuncion, Paraguay
TEL: +595-21-20-9126
FAX: +595-21-20-9127

- Peru

IATEC SAC

Av. Canaval y Moreyra 840 Ofic. 301
San Isidro, Lima 27
Peru
TEL: +51-1-226-4422

- Philippines

SALRITSU INTERNATIONAL TRADING CORPORATION

25/F Unit 2502, 139 Corporate Center
139 Valero St., Salcedo Village
Makati City 1227, Philippines
TEL: +632-893-8998/816-2646/812-4385
FAX: +632-815-0986

- Poland

ELSINCO POLSKA SP. Z.O.O.

ul Gdanska 50, PL-01-691 Warszawa
Poland
TEL: +48 (0)22-832 40 42
FAX: +48 (0)22-832 22 38

- Portugal

OMNILECTRO S.A.

Estrada de Alfragide, 43
2720-015 Amadora, Portugal
TEL: +351-21-4721210
FAX: +351-21-4721209

- Puerto Rico

CARIBBEAN DATA SYSTEM

636, San Patricio Ave. San Juan
PR00920-4507
Puerto Rico
TEL: +1-787-774-6969
FAX: +1-787-774-6973

- Qatar

QATAR COMMUNICATIONS LTD

P. O. Box 2481, Doha Qatar
TEL: +974-424347
FAX: +974-324777

- Romania

ELSINCO

Budapest KFT
Pannónia utca 8. IV/1
H-1136
Budapest
TEL: +36 (0)1 339 00 00
FAX: +36 (0)1 339 44 44

Authorized Distributor:

ROMKATEL S.R.L.

Str. Dristor Nr. 5, Bl. A20 Scara 2, Ap.
16RO-74321 Bucuresti 3
TEL: +40 21 322 74 40
FAX: +40 21 320 44 08

- Russia & CIS Countries

ELSINCO POLSKA SP.Z.O.O.

ul. Gdanska 50
PL-01-691 Warszawa
TEL: +48 (0)22-832-40-42
FAX: +48 (0)22-832-22-38

Authorized Distributor:

TELECOM TEST

Bld. 6, 4th Voykovsky proezd.
RU-125171 Moscow
TEL: +7 095 755 6592
FAX: +7 095 755 6593

- Saudi Arabia

A. RAJAB & A. SILSILAH & CO.

P. O. Box 203, Jeddah 21411
Saudi Arabia
TEL: +966-2-6610006
FAX: +966-2-6610558

ELECTRONIC EQUIPMENT MARKETING CO. (EEMCO)

No. 28, Baroudi Lane
Sulaymaniya, Riyadh 11481
Saudi Arabia
TEL: +966-1-477-1650
FAX: +966-1-478-5140
Add a New Country.

- Serbia

ELSINCO GmbH
Breitenfurter Str. 13
A-1120 Vienna, Austria
TEL: +43 (0)1 815 04 00
FAX: +43 (0)1 815 07 00

Authorized Distributor:

TETRA D.O.O.

V. Tomanovica 2
YU-11050 Beograd
TEL: +381 11 3470 720
FAX: +381 11 3470 700

- Singapore

ANRITSU PTE. LTD

10, Hoe Chiang Road #07-01/02
Keppel Towers, 089315
Singapore
TEL: +65-6282-2400
FAX: +65-6282-2533

- Slovakia

ELSINCO SLOVENSKO, S.R.O.

Kudláková 4, SK-841 01 Bratislava
Slovakia
TEL: +421 (0)2 6428 41 65
FAX: +421 (0)2 6428 44 54

ELSINCO SLOVENSKO, S.R.O.

(KOSICE BRANCH OFFICE)
Juzna trieda 6 SK-040 01 Kosice
Slovakia
TEL: +421 (0) 55 622 6729
FAX: +421 (0) 55 622 6729

- Slovenia

ELSINCO D.O.O.

Dalmatinova 2, SI-1000
Ljubljana, Slovenia
TEL: +386 (0)1 432 62 77
FAX: +386 (0)1 231 73 97

- South Africa

ETECESA (PTY) LTD

12 Surrey Square Office Park, 330 Surrey
Avenue, Ferndale, 2194 Randburg
South Africa
(P. O. Box 4231 Randburg, 2125 South Africa)
TEL: +27-11-787-7200
FAX: +27-11-787-0446

- Spain

ANRITSU LTD

European Sales Development Centre
200 Capability Green
Luton, LU1 3LU - United Kingdom
TEL: +44-1582-433 340
TEL: +44-1582-433 319
Local Support TEL: +34 91 640 4460

- Sri Lanka

INFOTECHS LTD

23/1 Jaya Road
Colombo 4, Sri Lanka
TEL: +94-1-583210
FAX: +94-1-584644

- Sweden

ANRITSU AB

Borgarfjordsgatan 13 A
164 40 KISTA
Sweden
TEL: +46(0)-8-534-707 00
FAX: +46(0)-8-534-707 30

- Switzerland

EXANOVIS AG

Moosstrasse 8a
3322 Schoenbuehl
Switzerland
TEL: +41-031-850-2525
FAX: +41-031-850-2520

- Taiwan

ANRITSU COMPANY, INC.

7F, NO. 316, Sec. 1, Neihu Road
Taipei, Taiwan R.O.C.
TEL: +886-2-8751-1816
FAX: +886-2-8751-1817

ANRITSU COMPANY, INC.

No. 21, Lane 23
Guandung Road
Hsinchu Taiwan
TEL: +886-3-563-6601
FAX: +886-3-564-5819

- Thailand

JASMINE TELECOM SYSTEM PUBLIC CO LTD

200 Moo 4, 9th Floor, Jasmine Intl Tower
Chaengwatana Rd., Tambon Pakkret,
Amphoe Pakkret, Nonthaburi
11120, Thailand
TEL: +(66)0-2502-3224
FAX: +(66)0-2502-3363

- Trinidad & Tobago

ANTEL COMMUNICATION SERVICES LTD.

24 10th Avenue Barataria
Trinidad & Tobago
TEL: (868) 674-1406
FAX: (868) 638-2409

• United Arab Emirates

UTMOST ELECTRONICS TRADING L.L.C.
(ABU DHABI BRANCH)
P. O. Box: 41175, Abu Dhabi
United Arab Emirates
TEL: +971-2-6458909
FAX: +971-2-6458907

• United Kingdom

ANRITSU LTD
200 Capability Green, Luton, Bedfordshire
LU1 3LU, United Kingdom
TEL: +44-1582-433200
FAX: +44-1582-731303

ANRITSU LTD
(LIVINGSTON OFFICE)
Unit 1, Knightsridge Industrial Estate
Turnbull Way, Knightsridge
Livingston EH54 8RB, United Kingdom
TEL: +44-1506-436111
FAX: +44-1506-436112

• United States

ANRITSU COMPANY
(CORPORATE OFFICES)
490 Jarvis Drive
Morgan Hill, CA 95037-2809, U.S.A.
Toll Free: 1-800-ANRITSU (267-4878)
TEL: +1-408-778-2000
FAX: +1-408-776-1744

ANRITSU COMPANY
1155 East Collins Blvd.
Richardson, TX 75081, U.S.A.
Toll Free: 1-800-ANRITSU (267-4878)
TEL: +1-972-644-1777
FAX: +1-972-671-1877

ANRITSU COMPANY
(SALES AND SERVICE, NJ OFFICE)
10 New Maple Avenue, Unit 305
P. O. Box 836,
Pine Brook, NJ 07058-0836, U.S.A.
Toll Free: 1-800-ANRITSU (267-4878)
TEL: +1-973-227-8999
FAX: +1-973-575-0092

• Uruguay

CABONORTE S.A.
Santa Lucia 5890
CP 11700
Montevideo Uruguay
TEL: +598 2 3095356
FAX: +598 2 3095776

• Venezuela

RADIOCOMUNICACIONES CRUZ C.A.
Calle la Colina, quinta Elison
Colina de los Caobos
Caracas 1050, Venezuela
TEL: +58-212-7932322
FAX: +58-212-7933429

• Vietnam

**SYSTEM & TECHNOLOGIES
VIETNAM LTD**
Unit # B236, Binh Minh Hotel
27 Ly Thai To St.
Hanoi, Vietnam
TEL: +84-4-8-264-728
FAX: +84-4-9-344-111

The Ideal Signal Generator**MG3690B RF/Microwave Signal Generator**

0.1 Hz to 67 GHz / 325 GHz

Your microwave signal generation requirements have never been tougher, and yet your capital equipment budget has never been tighter. You need the most value you can get in a synthesizer, but you can't compromise performance. You need a synthesizer that meets today's needs yet can be upgraded at a reasonable cost to satisfy future requirements without shattering your test equipment budget. Anritsu's MG3690B series of synthesizers deliver the highest performance and the highest value available today.

(For further information see page 15)

**For Evaluating Next Generation Digital Mobile Communications Systems****MG3700A Vector Signal Generator**

250 kHz to 3 GHz, 250 kHz to 6 GHz (Option)

Wireless communications, which are now evolving rapidly, are moving into high speed, large capacity, and wide band.

And next-generation wireless communications are addressing a new communication format that combines cellular phones with the access of wireless LANs.

MG3700A is a vector signal generator based on a 160 MHz arbitrary waveform generator that includes the features of "Wide vector modulation bandwidth" and a "Large capacity baseband memory."

MG3700A supports digital modulation of signals for various wireless communication systems, enabling you to evaluate general mobile communications, such as cellular phones and wireless LANs.

Anritsu's waveform generation software IQproducer™ can create waveform patterns and transmit them to the MG3700A via 100BASE-TX Ethernet. IQ sample data files (in ASCII format) programmed by using general EDA (Electronic Design Automation) tools such as MATLAB® can also be converted to waveform patterns for MG3700A.

And a custom-made waveform pattern file can be generated arbitrarily.

(For further information see page 21)



A new Plateau in Signal Analysis for providing exceptional Engineering Insight into wireless communication products
MS2781A Signature™ High Performance Signal Analyzer

100 Hz to 8 GHz

The MS2781A, Signature High Performance Signal Analyzer, is a combined high performance spectrum analyzer and a high performance vector signal analyzer. Signature expands the ability to analyze digitally modulated RF signals by offering seamless connectivity with MATLAB® and Simulink® from The MathWorks. Engineers can view measurement results through custom MATLAB and Simulink analysis giving exceptional insight into the performance of new designs. Signature can help make tomorrows communications systems a reality today.

(For further information see page 23)

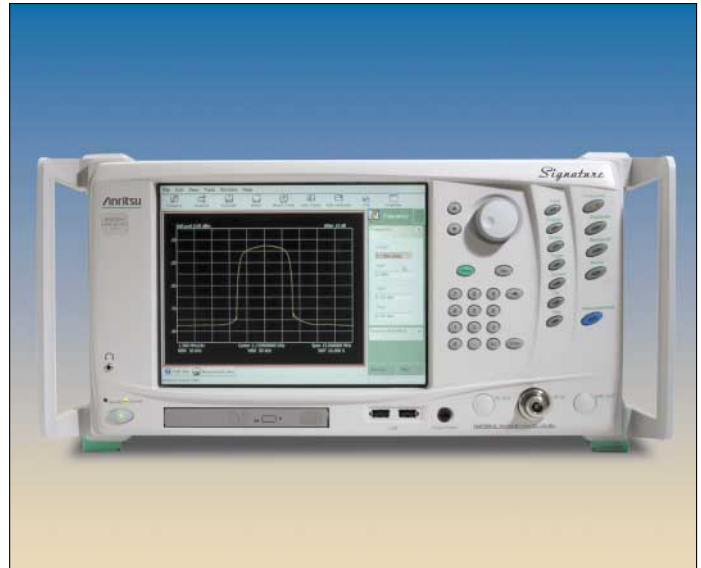

High Performance Handheld Spectrum Analyzer

MS2721A Spectrum Master

100 kHz to 7.1 GHz

The MS2721A Spectrum Master is the first handheld spectrum analyzer to deliver the ability to measure very low level signals with a displayed average noise level of ≤ -153 dBm typical @ 1 GHz in a 10 Hz RBW. Coupled with a wide range of resolution bandwidth choices, you can configure the Spectrum Master to meet your most challenging measurement needs. As the spectrum becomes more and more congested, the ability to measure low level, closely spaced signals becomes more and more important not only for interference detection but also for wireless system planning.

(For further information see page 34)



Broadband S-Parameter Measurements to 110 GHz and Beyond**ME7808B Broadband and Millimeter Wave VNA**

40 MHz to 110 GHz (expandable to 325 GHz)

The ME7808B Broadband Vector Network Analyzer (VNA) is a high performance measurement solution that covers 40 MHz to 110 GHz in a single fast sweep. Built on the advanced technology of the Lightning 65 GHz VNA, the ME7808B is ideal for making accurate S-parameter measurements of components and devices to 110 GHz. The flexible system architecture of the ME7808B makes it easy to adapt to multiple measurement applications. An alternate configuration is the ME7808B Millimeter Wave VNA that covers discrete millimeter wave bands from 50 to 325 GHz.

(For further information see page 41)

**For Fast and Accurate S-Parameter Measurements****37000D Series Lightning Vector Network Analyzers**

40 MHz to 65 GHz

The Lightning D-Series Vector Network Analyzers (VNAs) are high performance test tools designed to satisfy the growing needs of defense, satellite, radar, broadband communication, and high speed component markets. The new 37000D VNAs improve upon performance while providing a wider set of standard application features to better suit the need of R&D engineers working on next generation designs. These new features, when combined with the ease of programming through helpful software utilities and faster data transfer over Ethernet, make it an equally valuable tool for manufacturing as well.

(For further information see page 42)



For Single-Ended, Balanced-Differential and Mixed-Mode S-Parameter Measurements

37000D Series Microwave Multi-Port Balanced VNA

40 MHz to 65 GHz

The Microwave Multi-Port Balanced VNA consists of a Lightning 37000D VNA, a multi-port test set, and the Navigator™ Multi-Port software (external PC is required and is not included). The multi-port test set is a 2x4 switch matrix that allows either port on the VNA to connect with any of the 4 ports on the test set. The easy-to-use Navigator™ Multi-Port software provides full step-by-step direction, simplifying calibration, and speeding measurement throughput.

(For further information see page 44)



Single Connection Differential Measurements for Signal Integrity and Multi-Port Applications

MS4624D Series RF Multi-Port System

10 MHz to 9 GHz

The RF Multi-Port System consists of the Scorpion® Vector Network Measurement System, the SM5992 RF Multi-Port Test Set and Navigator™ software (external personal computer is required, but not included). Simply enter your multi-port module topology and Navigator guides you quickly and intuitively through the setup so you can accurately perform multi-port measurements. Especially suited for next generation modules with balanced interfaces, Navigator also supports full N-port calibrations for the ultimate in accuracy.

(For further information see page 53)



Single Connection Swept Frequency PIM and S-Parameters**MS4622B Series PIM-S System (VNA and Passive Intermodulation System)**

10 MHz to 3 GHz

The PIM-S System conducts passive intermodulation distortion (PIM) and S-parameter measurements with a single connection. This innovative system consists of the MS4622B Scorpion® Vector Network Measurement System (VNMS), SM612x PIM Power Amplifier Unit, SM612x PIM Filter Unit, and SM6130 PIM-S Software (external personal computer is required, but not included).

(For further information see page 54)



RF/MICROWAVE SIGNAL GENERATOR MG3690B

0.1 Hz to 67 GHz / 325 GHz



The Ideal Signal Generator

NEW



Value without compromise

Your microwave signal generation requirements have never been tougher, and yet your capital equipment budget has never been tighter. You need the most value you can get in a synthesizer, but you can't compromise performance. You need a synthesizer that meets today's needs yet can be upgraded at a reasonable cost to satisfy future requirements without shattering your test equipment budget. Anritsu's MG3690B series of synthesizers deliver the highest performance and the highest value available today.

Features

Basic CW Generators configurable to full-featured Signal Generators.

- Broad Frequency Coverage, in a Single Output: 0.1 Hz to 67 GHz
 - 6 Models, 2 to 10, 20, 30, 40, 50, and 67 GHz
 - 10 MHz Coverage Optional (Analog or Digital Down-Conversion)
 - 0.1 Hz Coverage Optional
- mmW Coverage up to 325 GHz, in Waveguide
- Ultra-Low SSB Phase Noise Option
- -110 dBc/Hz (typically) at 1 kHz Offset, 10 GHz Carrier
- Excellent Harmonics and Spurious Response
- High Output Power Option
 - +23 dBm to 10 GHz
 - +21 dBm to 20 GHz
 - +17 dBm to 40 GHz
 - +3 dBm to 65 GHz
- CW and Step Sweep Modes; Analog Sweep Optional
- <5 ms Switching Time (typically) for <100 MHz steps
- 0.01 Hz standard Frequency Resolution
- Phase Offset Capability
- AM, FM/ Φ M Modulations Optional
 - Internal LF Generator Optional
- Pulse Modulation Optional
 - 100 ns Leveled Width, >2 GHz
 - Internal Pulse Generator Optional
- IF Up-Conversion Option, for IQ Modulation Solutions
- Intuitive, Menu-driven Front Panel
- Small and Light
- Proven Reliability with 3 Year Standard Warranty
- Completely Configurable and Upgradable

High performance signal generators

The ultimate in full-function signal generation. They provide all the features of the other families along with comprehensive, high-performance modulation for signal simulation applications. Additional features in these units include:

- Internal pulse generator with swept delay capability for moving target simulation
- Flexible pulse triggering including free-run, delayed, gated, and composite
- 0 to 90% AM, log or linear, over DC to 100 kHz rates
- Four FM modes for up to 10 MHz deviation at 8 MHz rates or 100 MHz deviation at 100 Hz rates
- Phase modulation (Φ M) up to 400 radians deviation at 1 MHz rates
- Internal AM, FM, and Φ M generators, each with 7 modulating waveforms
- Optional user-defined, downloaded complex modulation

A new standard for a new millennium

The MG3690B leverages the proven design of earlier Anritsu synthesizers, adding new features to meet the latest needs of the new millennium. The MG3690B builds on a proven reliability record of >49,000 hours MTBF. This allows the MG3690B to offer a standard 3-year warranty. From the sleek new lines of the front panel, the larger 1/4 VGA LCD, the reduced front panel buttons and menu depth, to the 10 kg lighter and 15 cm shallower depth, the MG3690B meets the new millennium value-based needs.

Automatic Test Equipment

The MG3690B is an ideal signal generator for an A.T.E. system. It packs the highest performance available in a 13.3 cm (3u) package, with a 450 mm depth that minimizes rack space. High output power assures adequate signal strength to the device under test even after A.T.E. switching and cabling losses. Accurately leveled output power to -120 dBm in 0.01 dB steps facilitates receiver sensitivity measurements. For improved MTBF, an electronic step attenuator replaces the traditional mechanical step attenuator. Fast 5 ms switching time maximizes system throughput. Internal list mode frees the A.T.E. controller to perform measurement analysis tasks. Free application drivers, including the IVI-COM driver and National Instruments LabView® drivers, save you time and money in code generation and maintenance. For additional cost savings, Option 17 eliminates the complete front panel, including circuitry.

Interchangeable Virtual Instruments Standard

The IVI standard defines a standard instrument driver model that enables instrument interchangeability and interoperability without software changes. Anritsu's IVI-driver supported synthesizer minimizes instrument development and maintenance cost through the use of IVI-standard interfaces as well as instrument-specific interfaces for unique instrument features. The IVI standard provides a single driver that supports the common application development environments such as Visual Basic, Visual C++, and Labview. The flexible I/O model supports new communication technologies such as USB, Ethernet, and Firewire.

Anritsu Corporation leads the way with IVI technology, having released the first COM-based IVI driver supporting the Signal Generator instrument class, and includes the driver with every MG3690B series synthesizer. As an active member of the IVI Foundation, Anritsu supports the Foundation's drive toward instrument driver standardization as a powerful means of delivering interchangeable ATE instrumentation solutions.

SYNTHESIZED SIGNAL GENERATOR MG3633A 10 kHz to 2700 MHz



For Evaluation of Quasi-Microwaves and Measuring High-Performance Receivers



The MG3633A has excellent frequency resolution, frequency switching speed, signal purity, and a high output level, in addition to amplitude, frequency, and phase modulation functions. Also, sweep functions are provided for carrier frequency, output level, and modulation frequency so an appropriate sweep can be performed for various devices to be measured.

The MG3633A has a frequency memory that can store 1000 carrier frequencies and a function memory that stores 100 panel settings. Moreover, since the maximum output level is +17 dBm, it can be used for various local signal sources.

The MG3633A is suitable for research and development of mobile communications in the quasi-microwave band, performance evaluation, characteristics testing, and adjustment of various types of radio equipment such as digital land-based mobile communications, mobile satellite communications, satellite broadcasting, and radio LANs.

Features

• Low noise

By using both the latest synthesizer and RF-device technologies and optical data links in the internal control circuit, the SSB phase noise has been cut to -140 dBc/Hz (CW, 1.1 GHz, offset 20 kHz). In particular, the MG3633A shows its power for generating signals used for testing radio receiver selectivity, for generating high-speed clocks of A/D converters and dividers, as well as for generating standard signals for communications links. Since the residual FM is 0.8 Hz rms or less (1.28 GHz or less), even the S/N ratio of narrow-band mobile radio equipment can be measured with sufficient margin (Figure 2).

• High accuracy and high-output level

Low levels of -123 dBm can be set with ± 1 dB accuracy by using a high-accuracy programmable attenuator. The output level can be displayed in units of dBm, dB μ V, V, mV, and μ V or as a relative value (dB).

• Modulation characteristics

The MG3633A has AM, FM, ϕ M, and a combination of all three modulation functions. A DC mode is provided for FM, which makes simulation of digital transmissions for a pager possible. Also, a built-in AF oscillator with a 0.1 Hz to 100 kHz synthesizer can handle various modulations.

• Quasi-microwave output

The MG3633A covers a wide range (from 10 kHz to 2700 MHz) and is suitable for research and development, as well as production of quasi-microwave band radio equipment.

Performance

• Signal purity

The MG3633A has excellent spectral purity. As shown in the Figure 1, the SSB phase noise at 1 GHz with 20 kHz signal offset is -140 dBc/Hz. In particular, this shows its power for generating signals used for testing radio receiver selectivity, for generating high-speed clocks of A/D converters and dividers, as well as for generating standard signals for communications links. Since the residual FM is 0.8 Hz rms or less (1.28 GHz or less), even the S/N ratio of narrow-band mobile radio equipment can be measured with sufficient margin (Figure 2).

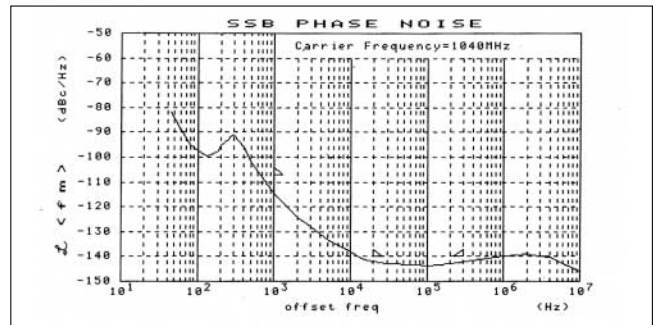

Figure 1. SSB Phase Noise

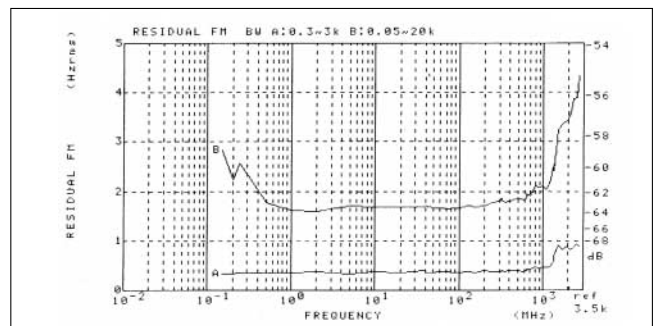

Figure 2. Residual FM

• **Output level characteristics**

A maximum output of +17 dBm can be obtained over a wide frequency range so 2-signal or 3-signal testing can be done easily. A high-accuracy highly-reliable programmable attenuator (life cycle over 3 million times) is used and, since flat output characteristics are obtained by internal calibration over a wide range from 10 kHz to 2.7 GHz, it is effective for testing antennas and cables (Figure 3).

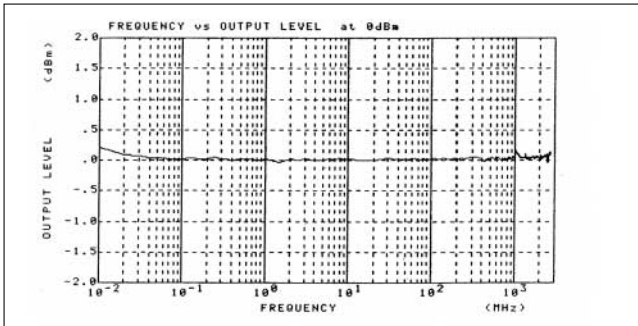

Figure 3. Output Level Frequency Response

Compensation data for obtaining flat levels at cable ends can be input by using a power meter, GPIB, controller, and frequency-response compensation software (optional).

• **Continuously variable output level**

The MG3633A can output continuously-variable signals in a 20 dB range with 0.1 dB steps at any level. This is especially convenient for measuring the dynamic range of magnetic tape and squelch sensitivity of radios which produce hysteresis phenomenon as a result of level variation.

• **AM**

A high-accuracy AM wave is generated over a wide frequency range (Figure 4). Countermeasures against carrier-wave variation due to vibration permit even SSB radio equipment to be tested with confidence.

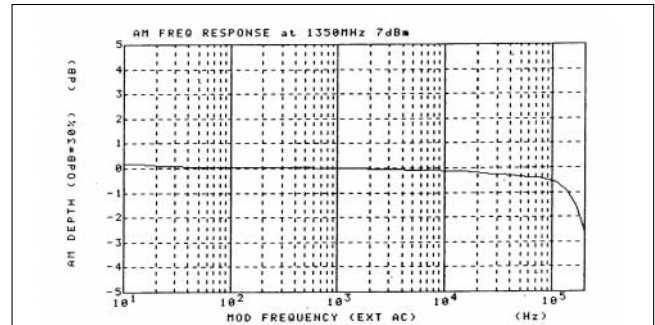

Figure 4. AM Modulation Frequency Characteristics

• **FM**

FM with a maximum frequency deviation of 3.2 MHz is possible (1.28 to 2.7 GHz). Also if the frequency deviation is too low, automatic operation is carried out in the stabilized DC-FM mode so even digital data transmission equipment such as papers can be tested (Figure 5).

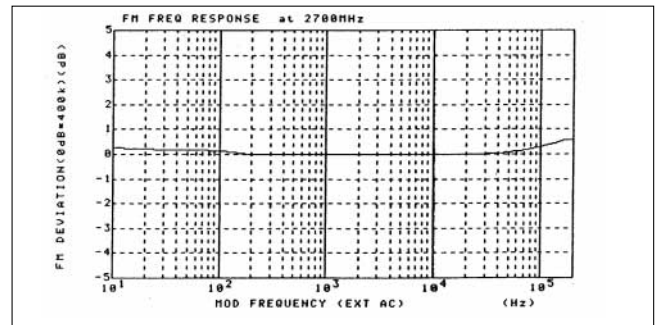

Figure 5. FM Modulation Frequency Characteristics

SYNTHESIZED SIGNAL GENERATOR
MG3641A/MG3642A



125 kHz to 1040/2080 MHz

Economic High-Performance Signal Sources



The frequency of MG3641A/3642A is set with a resolution of 0.01 Hz across the full frequency ranges, and the non-harmonic spurious is better than -100 dBc for reliable measurement at any frequency. A low-noise YIG oscillator produces a high-purity signal with SSB phase noise of better than -130 dBc/Hz (1 GHz, 20 kHz offset) making these signal generators ideal for interference testing of radio receivers and as sources for various local and reference signals.

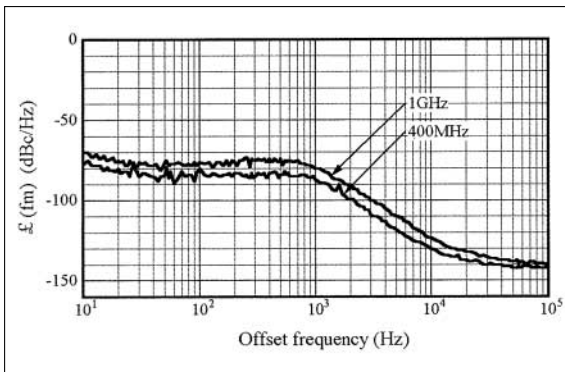

SSB phase noise characteristic

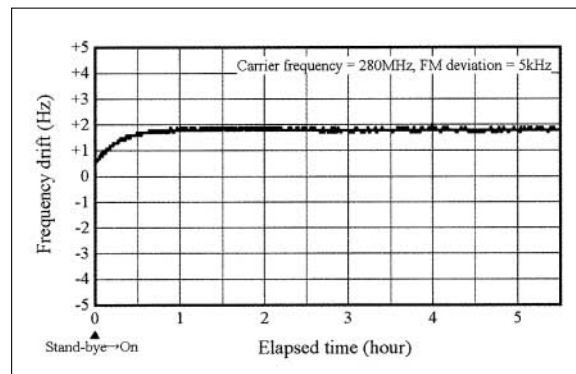

Carrier wave frequency stability at frequency modulation

• High output

A stable signal with an output of +17 dBm can be output across the full frequency range to drive a variety of local signal sources and power amplifiers. In addition, an overdrive level up to +23 dBm can be set so as to make full use of the internal amplifier capability. If the amplifier's output power comes up to the limitation and output power does not reach the set value, a status message is displayed. This is useful for confirming the output limits.

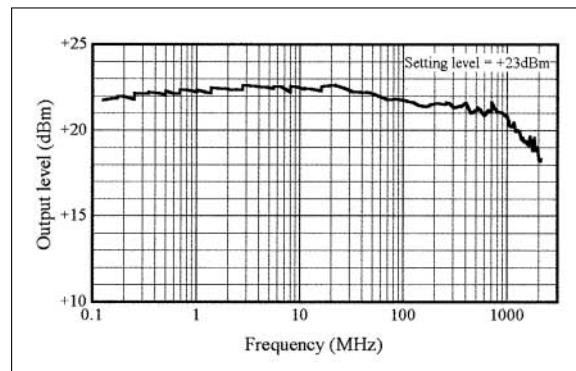

Maximum output level

Features

- 0.01 Hz, 0.01 dB setting resolution
- High signal purity (-100 dBc spurious)
- Versatile modulation functions

Performance

• High-stable carrier frequency

The carrier frequency is produced by a high-stability crystal oscillator and remains phase locked even at frequency modulation. Frequency calibration for testing FSK modulation receivers, such as paging systems, is not necessary.

• Various modulation types

Up to three internal AF signal sources can be incorporated by adding options to the standard sine-wave oscillator (1 kHz, 400 Hz). The AF synthesizer (Option 21) is a digital synthesizer for generating sine-wave, triangular, square, and sawtooth waveforms; it can also be used as a function generator as well as a modulation signal source. In addition to permitting simultaneous one-route AM and two-route FM modulation, the modulation factor and polarity can be set independently. Installing the pulse modulator (Option 11) in the MG3641A/3642A allows them to generate high-speed pulse modulation using an external modulation signal (TTL level). The output can be used for various burst signals with an ON/OFF ratio of more than 80 dB, as well as a pseudo-random signal for radar. Installing the pattern generator (Option 23) in the MG3641A/3642A allows them to generate FSK or pulse modulation combined with FSK encoder (Option 22) or pulse modulator (Option 11) without an external instrument.

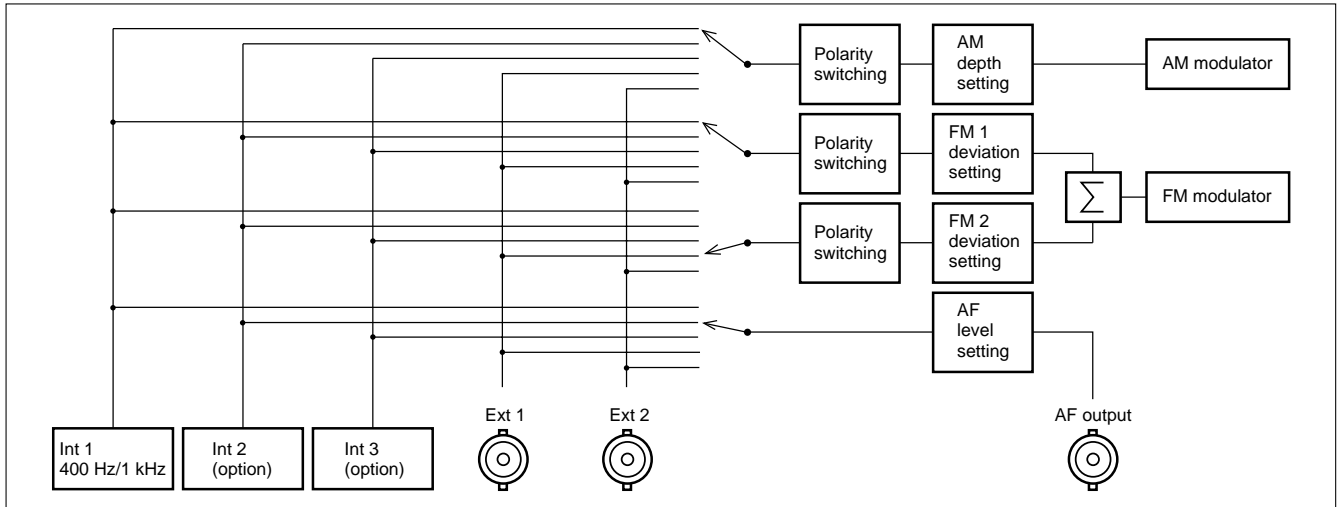

• GPIB Only-Mode linked operation

Two sets of MG3641A/3642A can be linked and operated without an external controller using the Frequency and Output Level Only Modes. The Frequency Only Mode in the frequency offset functions is used for evaluating the characteristics of mixers. The Level Only Mode is useful for evaluating the cross-modulation characteristics of non-linear devices such as amplifiers.

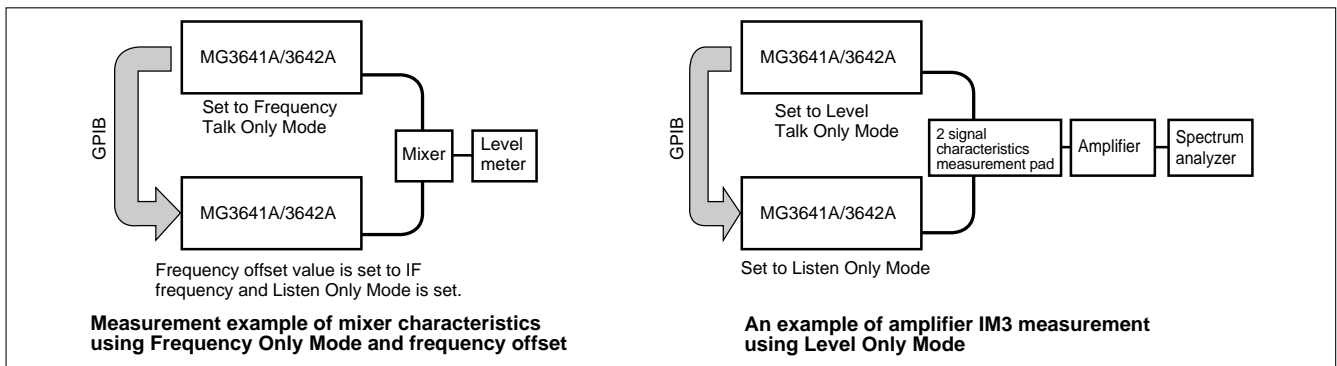

• Pattern generator (Option 23)

Installing the pattern generator (Option 23) in the MG3641A/3642A allows them to generate FSK or pulse modulation combined with FSK encoder (Option 22) or pulse modulator (Option 11) without an external instrument.

VECTOR SIGNAL GENERATOR MG3700A

250 kHz to 3 GHz, 250 kHz to 6 GHz (Option)



For Evaluating Next Generation Digital Mobile Communications Systems

NEW



Wireless communications, which are now evolving rapidly, are moving into high speed, large capacity, and wide band. And next-generation wireless communications are addressing a new communication format that combines cellular phones with the access of wireless LANs.

MG3700A is a vector signal generator based on a 160 MHz arbitrary waveform generator that includes the features of "Wide vector modulation bandwidth" and a "Large capacity baseband memory." Furthermore, MG3700A supports digital modulation of signals for various wireless communication systems, enabling you to evaluate general mobile communications, such as cellular phones and wireless LANs.

Anritsu's waveform generation software IQproducer™ can create waveform patterns and transmit them to MG3700A via 100BASE-TX Ethernet. Furthermore, IQ sample data files (in ASCII format) programmed by using general EDA (Electronic Design Automation) tools such as MATLAB® can also be converted to waveform patterns for MG3700A.

And a custom-made waveform pattern file can be generated arbitrarily.

Performance and functions

- **Frequency Range 250 kHz to 6 GHz**
250 kHz to 3 GHz (standard)
250 kHz to 6 GHz (option)
- **Wide vector modulation bandwidth**
120 MHz (Internal base band generator)
150 MHz (External IQ input)
- **High level accuracy**
±0.5 dB (Absolute level accuracy)
±0.2 dB typical (Linearity)
- **High speed waveform transmission by 100BASE-TX Ethernet.**
- **40 GByte hard disk is built in.**

- **Large capacity baseband memory.**
1 GBytes = 256 Msamples/channel (standard)
2 GBytes = 512 Msamples/channel (option)
- **Waveform addition function**
Two signals, such as wanted signal + interfering signal or wanted signal + AWGN, can be added and outputted.
- **Standard 20 Mbps BERT analyzer is built in.**

Support for various communication systems Standard

- **Waveform Patterns:**
Arbitrary waveform patterns corresponding to the following communication systems are included as standard.
Features:
WCDMA/HSDPA, GSM/EDGE, CDMA2000® 1x/1xEV-DO
Wireless LAN (IEEE802.11a/b/g), PDC, PHS, AWGN
- **Optional Waveform Patterns:**
Arbitrary waveform patterns corresponding to the following communication systems are provided as options:
TD-SCDMA
Public Radio System (RCR STD-39, ARIB STD-T61/T79/T86)
- **Waveform generation software: IQproducer™**
(Software license is optional)
IQproducer™ is PC application software with a graphical user interface for changing parameters and generating waveform patterns that comply with various communication systems:
HSDPA, TDMA, CDMA2000 1xEV-DO
* Please refer to the catalog "MX370x series software" for details.

IQproducer is a registered trademark of Anritsu Corporation.
MATLAB is a registered trademark of The Math works, Inc.
CDMA2000 is a registered trademark of the Telecommunications Industry Association (TIA-USA).

Covers frequency range 250 kHz to 6 GHz

Choose either 250 kHz to 3 GHz (standard) or 250 kHz to 6 GHz (option) for the frequency range. A 6 GHz upper frequency is required for the WLAN 5 GHz band frequency and next-generation communication system support.

Wide vector modulation bandwidth

- 120 MHz (Using internal baseband signal generator)
- 150 MHz (Using External IQ input)

A wider "RF modulation bandwidth" of 120 MHz is achieved when internal baseband signal generation is used. Furthermore, 150 MHz vector modulation bandwidth is supported for up to 6 GHz frequency when the External IQ inputs are used.

- Suitable for research and development of the next-generation communication systems supporting wider bandwidths and multi-carrier signals.
- An external arbitrary waveform generator is unnecessary.

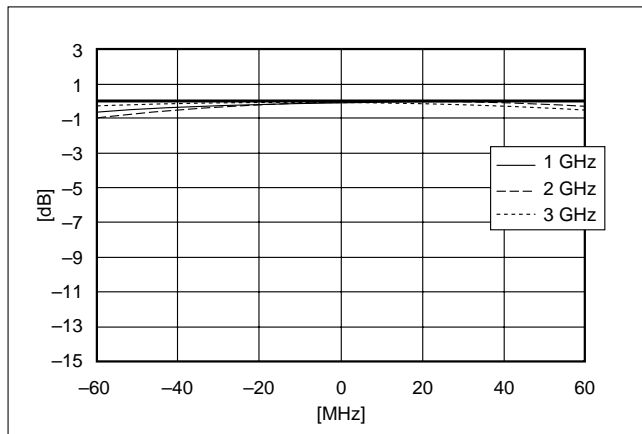

Waveform combining function

MG3700A contains two built-in arbitrary waveform memories, and these two memories can each choose one waveform pattern, respectively. MG3700A can output the signal of either one of the memories, and can also combine and output both signals simultaneously. When measuring receiver characteristics, such as "ACS: Adjacent

Channel Selectivity" or "Blocking characteristics", the "Wanted Signal+Interfering Signal" and "Wanted Signal+AWGN" can be outputted by one MG3700A.

Since digital processing is used for adjustment and S/N, the level ratio accuracy is excellent.

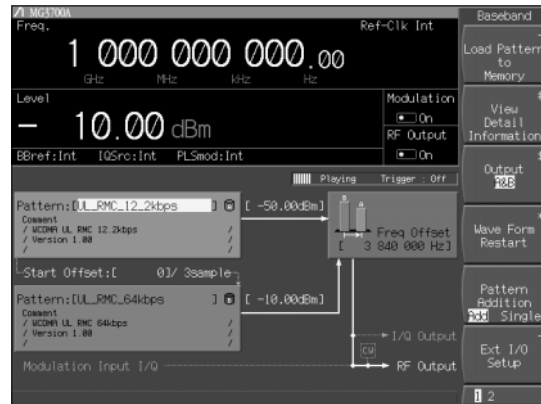

Wanted Signal + Interfering Signal screen

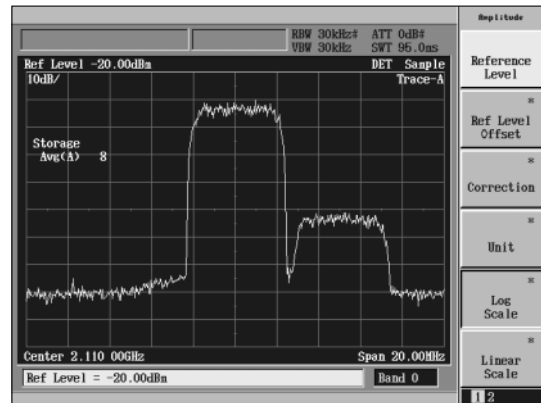

Output waveform screen

Software selection guide

Communication system	Waveform pattern			IQproducer		
	Standard	MX370001A TD-SCDMA	MX370002A Public Radio System	MX370101A HSDPA	MX370102A TDMA	MX370103A CDMA2000 1xEV-DO
WCDMA	√			√		
HSDPA	√			√		
GSM	√					
EDGE	√					
CDMA2000	√					
CDMA2000 1xEV-DO	√					√
TD-SCDMA		√				
PDC	√				√	
PHS	√				√	
WLAN IEEE802.11a	√					
WLAN IEEE802.11b	√					
WLAN IEEE802.11g	√					
RCR STD-39			√			
ARIB STD-T61			√		√	
ARIB STD-T79			√		√	
ARIB STD-T86			√		√	
AWGN	√					

HIGH PERFORMANCE SIGNAL ANALYZER
MS2781A Signature™
 100 Hz to 8 GHz



A New Plateau in Signal Analysis for Providing Exceptional Engineering Insight into Wireless Communication Products

NEW

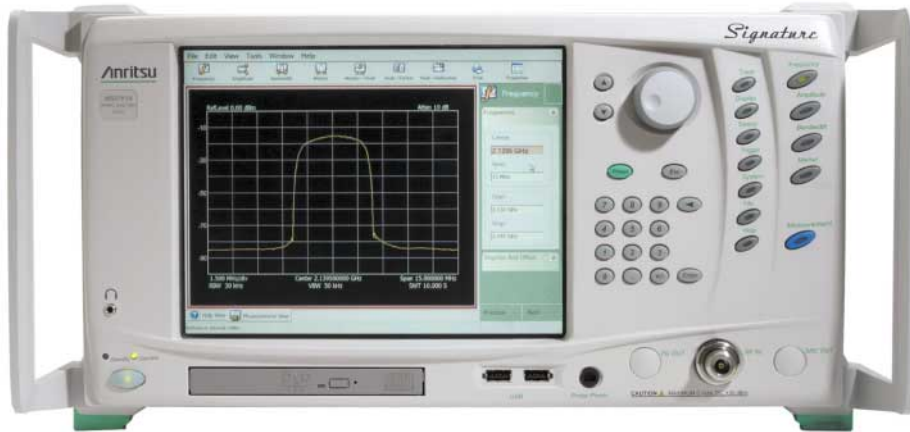

The MS2781A Signature High Performance Signal Analyzer is a combined high performance spectrum analyzer and a high performance vector signal analyzer. Signature expands the ability to analyze digitally modulated RF signals by offering seamless connectivity with MATLAB® and Simulink® from The MathWorks. Engineers can view measurement results through custom MATLAB and Simulink analysis giving exceptional insight into the performance of new designs. Signature can help make tomorrows communications systems a reality today.

Features

- Fundamentally mixed, single band architecture covers 100 Hz to 8 GHz
- Capture and analyze complex modulated signals with up to 30 MHz bandwidth
- Windows® XP Professional environment for ease-of-use and exceptional connectivity
- MATLAB® connectivity allows simultaneous analysis while taking a measurement

Performance and functions

100 Hz to 8 GHz

The 100 Hz to 8 GHz frequency range is covered in one band as illustrated in the RF block diagram. This one-band approach improves performance. Resolution bandwidths ranging from 0.1 Hz to 8 MHz support improved sensitivity and demodulation of wideband signals.

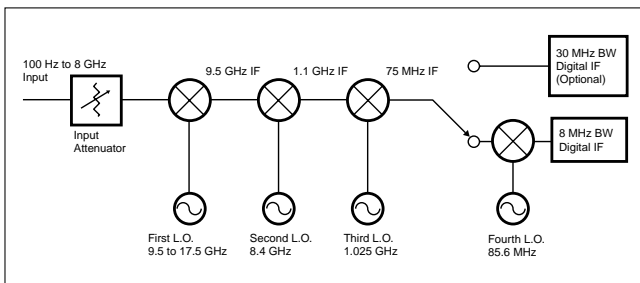

30 MHz Modulation Capture Bandwidth

Option 22 provides a 30 MHz capture bandwidth to allow vector signal analysis on wideband signals such as 802.16.

+23 dBm TOI and -145 dBm DANL

+23 dBm Third Order Intercept (TOI) performance and -145 dBm Displayed Average Noise Level (DANL) support intermodulation measurements on high performance devices such as multi-carrier power amplifiers.

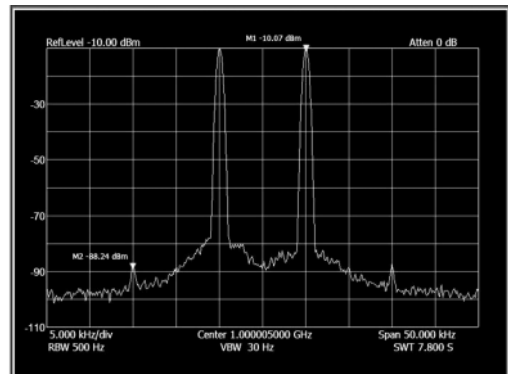

Open Windows XP

The fully functional, built-in, open Windows PC and Windows XP user interface makes the MS2781A easy to connect with and easy to use.

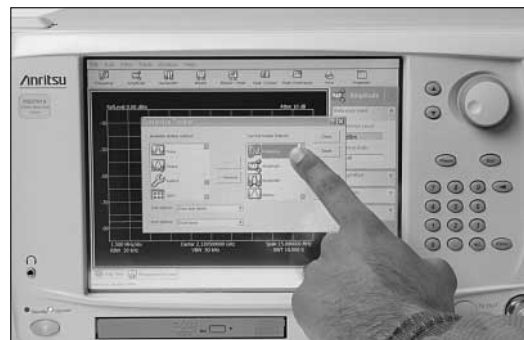

MATLAB Connectivity

Option 40, MATLAB connectivity, makes it possible to view custom analysis with measurements.

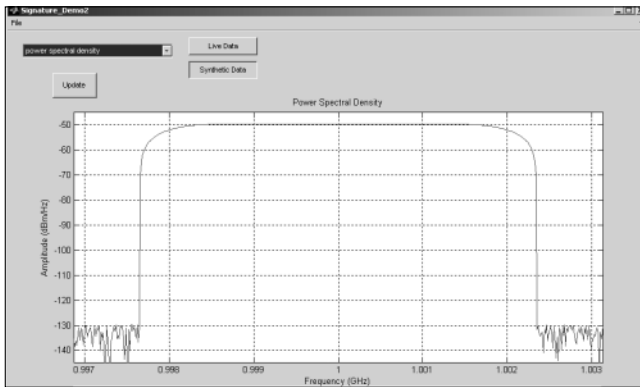
**30 MHz Modulation Capture Bandwidth (Option 22)**

Option 22 allows single FFT spectrum and I-Q vector measurements to 30 MHz and enables vector signal analysis capability (Option 38). Baseband differential I & Q inputs are also added.

Fully Integrated Vector Signal Analysis (Option 38)

Option 38, QAM/PSK Modulation Analysis, allows you to select the symbol rate, modulation type, and filtering to demodulate captured signals. Measurements include EVM, carrier leakage, and I-Q imbalance. Symbol table, constellation and vector diagrams enhance viewing of measurement results.

Integrated Compatibility with Industry-Leading Simulation Tools

Signature expands the ability to analyze RF signals with industry-leading simulation and analysis tools from The MathWorks. A 30 day free evaluation version of MATLAB is available with Signature along with example applications. See <http://www.mathworks.com/anritsu> for details. The MathWorks products provide analysis, visualization and modeling tools.

SPECTRUM ANALYZER
MS2661C
9 kHz to 3 GHz

For Analyzing Digital Radio Equipment and CATV Signals



The MS2661C Portable Spectrum Analyzer is for signal analysis of radio and other equipment related to improving frequency usage efficiency, higher modulation, and digitalization. The MS2661C is a synthesized spectrum analyzer covering a wide frequency range from 9 kHz to 3 GHz and it has superior basic performance such as high C/N ratio, low distortion, and a high frequency/level accuracies.

The MS2661C has a "Measure" function for evaluation of radio equipment (frequency counter, C/N, adjacent channel power, occupied frequency bandwidth, burst average power, and template decision function), which enables the two-screen display and FM demodulation waveform display. The large selection of options means that a wider range of applications can be handled at a reasonable cost.

SPECTRUM ANALYZER
MS2663C
9 kHz to 8.1 GHz

For Measuring up to 3rd Order Spurious Frequencies in the Mobile Communications Band



The MS2663C covers a frequency range of 9 kHz to 8.1 GHz. This allows measurement of spurious frequencies of up to three times greater than the frequency bands used worldwide for mobile communications. The MS2663C has superior basic performance such as high C/N ratio, low distortion, and high frequency/level accuracies and is easy to operate.

The MS2663C has a "Measure" function for evaluation of radio equipment (frequency counter, C/N, adjacent channel power, occupied frequency bandwidth, burst average power, and template decision function), which enables the two screen display and FM demodulation waveform display. The large selection of options means that a wider range of applications can be handled at a reasonable cost.

SPECTRUM ANALYZER
MS2665C
9 kHz to 21.2 GHz



For Evaluating ETC Subscriber Radio Systems

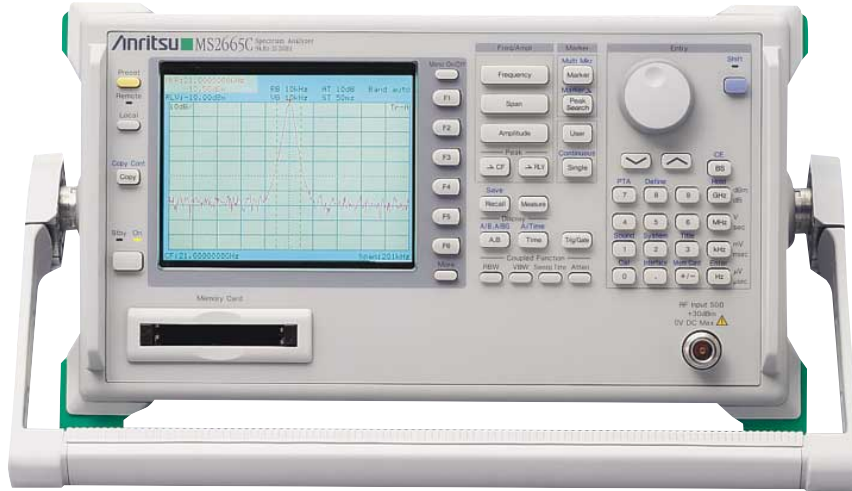

The MS2665C is a compact, lightweight, and low-price spectrum analyzer that covers a frequency range of 9 kHz to 21.2 GHz. It has superior basic performance such as a high C/N ratio, low distortion, and high frequency/level accuracies and is easy to operate. A large selection of options is provided to handle a wide range of applications at a reasonable cost.

Features

- Compact and lightweight (13 kg in standard configuration)
- High C/N and superior distortion characteristics
- Easy-to-use, simple operation
- Options support wide range of applications
- Easy to set up automatic measurements

Performance and functions

• Counter with 1 Hz resolution

A full complement of frequency counter functions are provided. Resolution is as high as ± 1 Hz even at full span, and high-speed frequency measurements can be performed. The high sensitivity compared with ordinary counters makes it easy to select one signal from many and to determine its frequency.

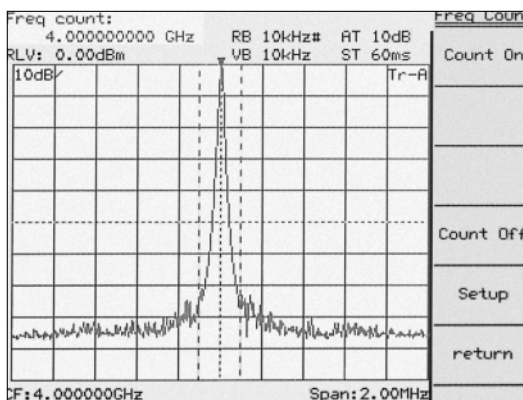

Frequency measurement (1 Hz resolution)

• 100 dB display dynamic range

For measurements requiring a wide dynamic range, such as adjacent channel power measurements, the MS2665C can display nearly 90 dB on a single screen.

• Multi-screen display

The Trace A and Trace B waveforms are superimposed on the same screen, and two spectra with different frequencies are displayed simultaneously. In addition, it is possible to simultaneously display spectrum and time domain screens for the same signal. The multi-screen display permits efficient signal level adjustment and harmonic distortion measurement. In addition to being able to display amplitude in the time domain, it is also possible to display the FM demodulation waveform.

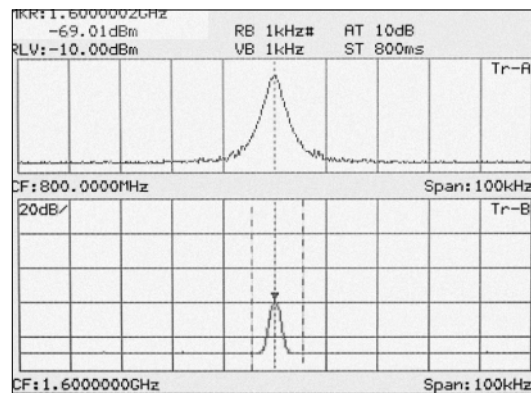

Two traces with different frequencies

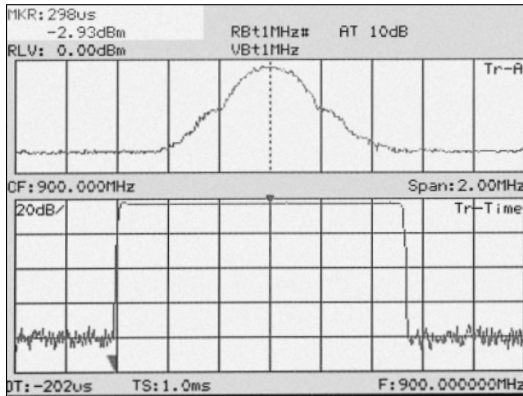

Spectrum and time domain measurement

• For testing digital mobile communication equipment
High-speed time domain sweep (Option 04)

Testing of TDMA-type radio equipment includes time domain (zero-span) measurements of antenna power, transient response characteristics of burst transmissions, transmission timing, and other quantities. The high-speed time domain sweep option boosts sweep time to 12.5 μ s and resolution to 0.025 μ s.

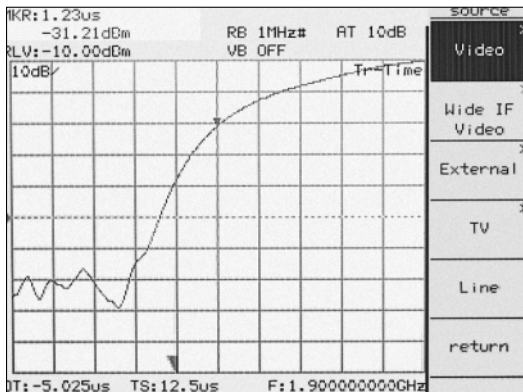

High-speed time-domain measurement (TS = 12.5 μ s)

Trigger/gate circuit (Option 06)

The burst signal can be measured using the trigger function in time domain measurements. External, video, wide IF video, or line is selectable. This makes a variety of TDMA radio equipment tests possible, including template comparison using pre-trigger and post-trigger delay functions and gate spectrum analysis using the gate sweep function. Previously, the trigger output from an external detector was required in gate spectrum analysis. However, this option for the MS2665C has a 20 MHz wide IF video trigger function, eliminating the need for trigger output from an external detector.

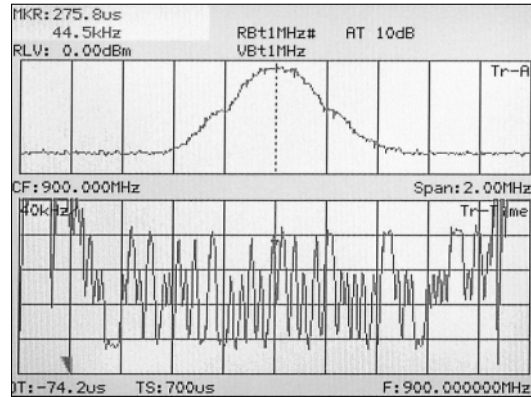

Wide IF video trigger function

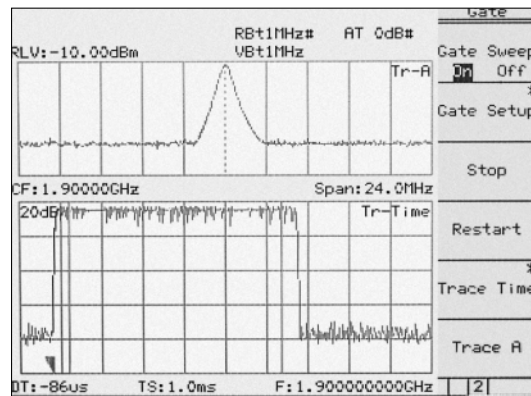

Wide IF video trigger and gate functions

SPECTRUM ANALYZER
MS2667C
9 kHz to 30 GHz



For Evaluating LMDS Subscriber Radio Systems



The MS2667C is a compact, lightweight, and low-price spectrum analyzer that covers a frequency range of 9 kHz to 30 GHz. It has superior basic performance, such as a high C/N ratio, low distortion, and high frequency/level accuracies, and is easy to operate. A large selection of options is provided to handle a wide range of applications at reasonable cost.

Features

- Compact and lightweight (15 kg in standard configuration)
- High C/N and superior distortion characteristics
- Easy-to-use, simple operation
- Millimeter wave applications
- Options support a wide range of applications

Performance and functions

• Counter with 1 Hz resolution

A full complement of frequency counter functions are provided. Resolution is as high as ± 1 Hz even at full span, and high-speed frequency measurements can be performed. The high sensitivity compared with ordinary counters makes it easy to select one signal from many and to determine its frequency.

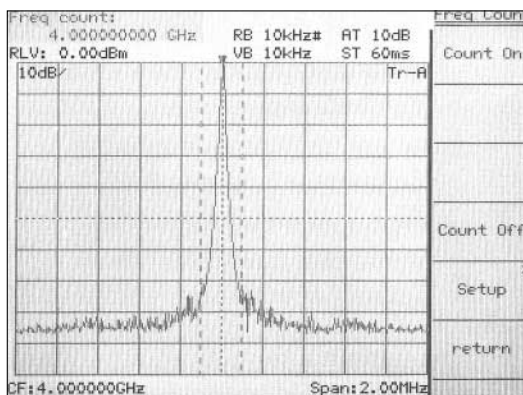

Frequency measurement (1 Hz resolution)

• 100 dB display dynamic range

For measurements requiring a wide dynamic range such as adjacent channel power measurements, the MS2667C can display nearly 90 dB on a single screen.

• Highly-accurate measurement

Automatic calibration ensures a high level of accuracy. A span accuracy of 5% and 501 sampling points ensure accurate occupied frequency bandwidth and adjacent channel power measurements.

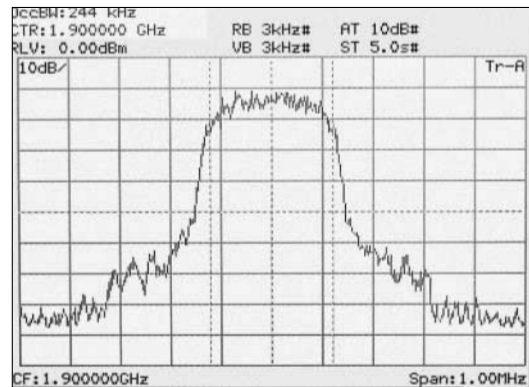

Occupied bandwidth measurement

• **Radio equipment evaluation functions (“measure” functions)**
 A full range of functions including measurement of power levels, frequencies, adjacent channel power, and mask and time template measurements are provided for performance evaluation of radio equipment. Key operation is simple and high-speed calculations make the measurement fast and efficient.

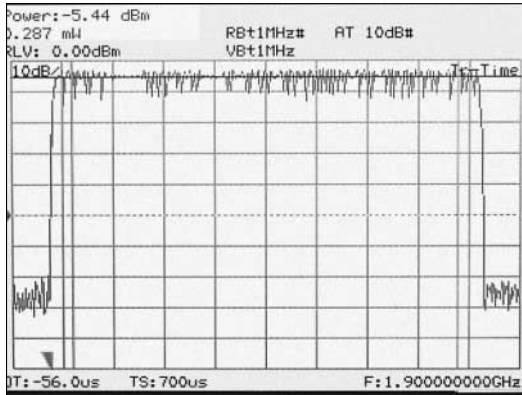

Burst average power measurement

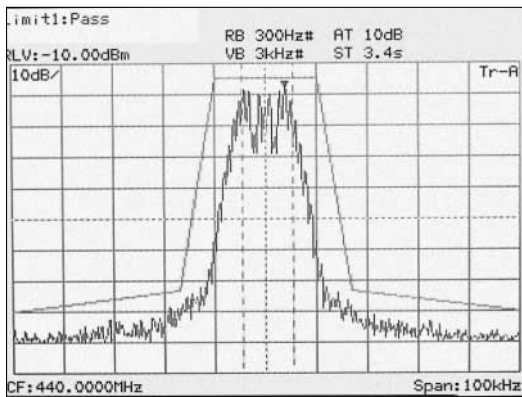

Mask measurement

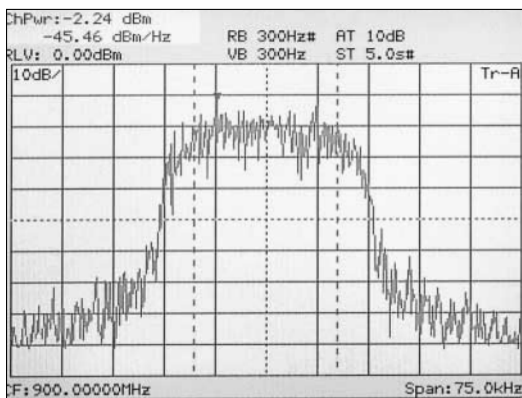

Channel power measurement

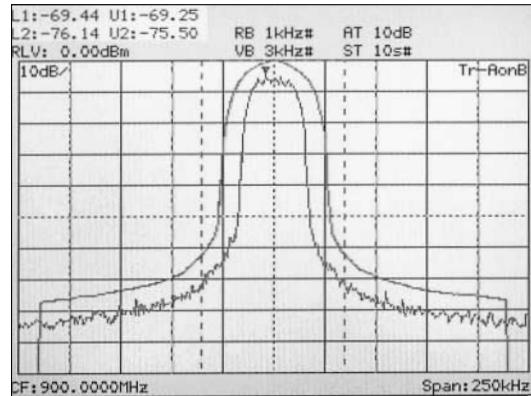

Adjacent channel power measurement

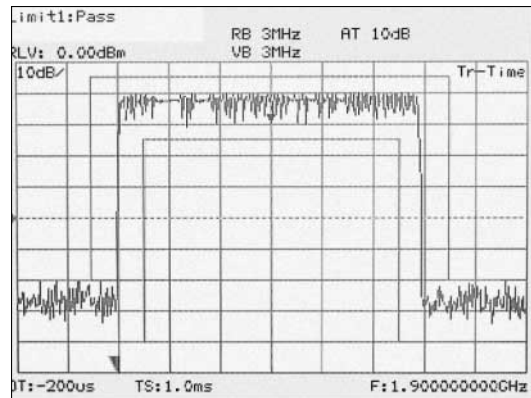

Time template measurement

• **Zone sweep and multi-zone sweep functions**

Sweeps can be limited to zones defined by zone markers which results in reduced sweep time. This zone sweep function can be combined with “measure” functions such as “noise measure,” which can directly readout the total noise power within the zone to reduce measurement time greatly. The multi-zone sweep function enables up to 10 zones to be swept.

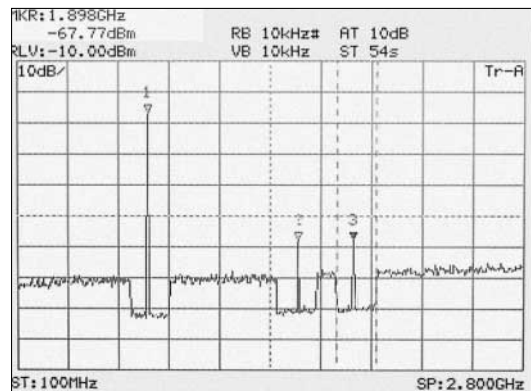

Multi-zone sweep

SPECTRUM ANALYZER
MS2668C
9 kHz to 40 GHz



For Measuring High-Speed Communications, such as MMAC and ITS



In recent wireless communication market, the utilization of microwave/millimeter wave band frequencies is being considered in order to realize high-speed and large-capacity data communication. In the markets of ITS and ultrahigh-speed wireless LAN, aiming for the speedup of wireless LAN which began to be spread as a typical application, millimeter wave band is used for realizing collision avoidance radar. MS2668C is a portable and high-performance spectrum analyzer that has various radio evaluation functions for microwave/millimeter wave devices and systems.

Features

- Compact and lightweight (15 kg in standard configuration)
- High C/N and superior distortion characteristics
- Easy-to-use, simple operation
- Millimeter wave applications
- Options support a wide range of applications

Performance and functions

• Counter with 1 Hz resolution

A full complement of frequency counter functions are provided. Resolution is as high as ± 1 Hz even at full span, and high-speed frequency measurements can be performed. The high sensitivity compared with ordinary counters makes it easy to select one signal from many and to determine its frequency.

• Radio equipment evaluation functions (“measure” functions)

A full range of functions including measurement of power levels, frequencies, adjacent channel power, and mask and time template measurements are provided for performance evaluation of radio equipment. Key operation is simple and high-speed calculations make the measurement fast and efficient.

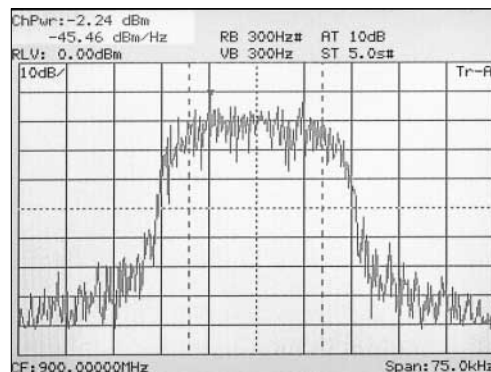

Channel power measurement

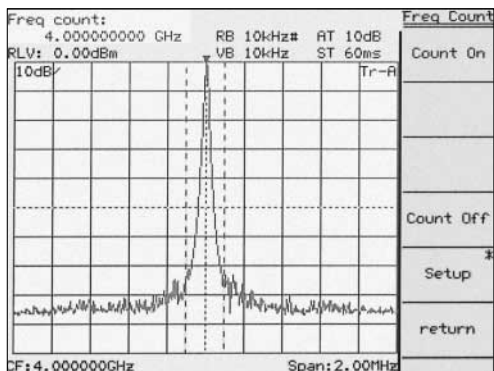

Frequency measurement (1 Hz resolution)

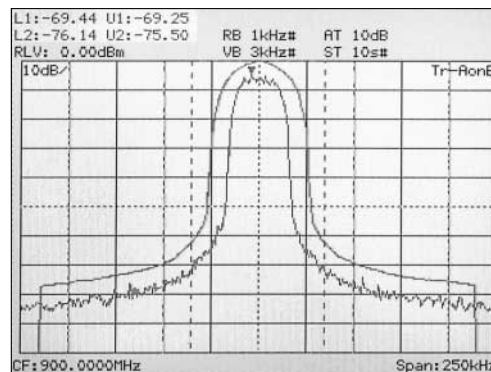

Adjacent channel power measurement

- **Multi-screen display**

The Trace A and Trace B waveforms are superimposed on the same screen, and two spectra with different frequencies are displayed simultaneously. In addition, it is possible to simultaneously display spectrum and time domain screens for the same signal. The multi-screen display permits efficient signal level adjustment and harmonic distortion measurement.

In addition to being able to display amplitude in the time domain, it is possible to display the FM demodulation waveform.

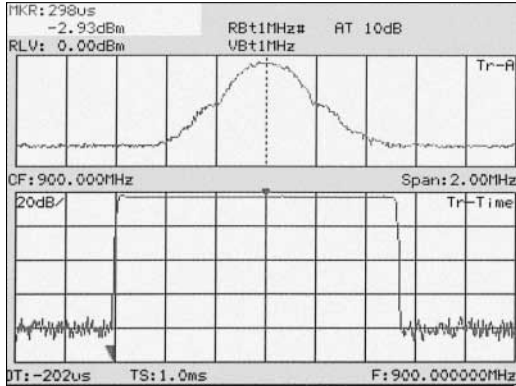

Spectrum and time domain measurement

- **For testing digital mobile communication equipment**

- **High-speed time domain sweep (Option 04)**

Testing of TDMA-type radio equipment requires time domain (zero-span) measurements of antenna power, transient response characteristics of burst transmissions, transmission timing, and other characteristics. The high-speed time domain sweep option boosts sweep time to 12.5 μ s and resolution to 0.025 μ s. This option must be used with the trigger/gate circuit (Option 06).



High-speed time domain measurement (TS = 12.5 μ s)

SPECTRUM ANALYZER
MS2681A/2683A/2687B

9 kHz to 3/7.8/30 GHz



For Evaluation of IMT-2000, Bluetooth™, MMAC and Advanced Radio Communication Devices

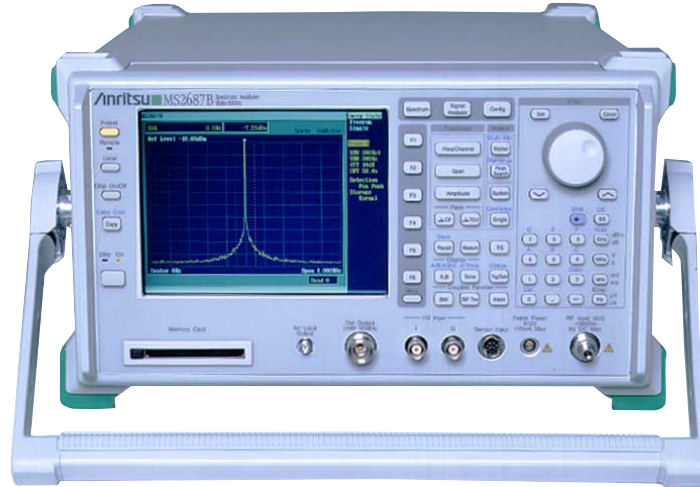

The IMT-2000 (2 GHz band) service for third-generation mobile radio communication has started. Bluetooth has been adopted for close-range radio communication between portable remote terminals and peripheral equipment, and R&D of MMAC, IEEE802.11a, and HiperLAN2 (High Performance European Radio Local Area Network Type 2) for higher speed access have been conducted in various countries.

The MS2681A/2683A/2687B spectrum analyzer delivers optimum performance over a wide dynamic range (156 dB, typical value), wide resolution bandwidth (20 MHz), to high-speed sweep (refresh rate of 20 times/s), required for evaluating next-generation radio communication systems and devices.

It can be used not only as a spectrum analyzer but also to perform various measurements easily and quickly by installing measurement software.

Application software

Support system	Name
WCDMA	WCDMA measurement software
GSM	GSM measurement software
cdmaOne, CDMA2000 1X	cdma measurement software
CDMA2000 1xEV-DO	CDMA2000 1xEV-DO measurement software
PDC/PHS/NADC (IS-136), STD-39/T79, STD-T61	$\pi/4$ DQPSK measurement software
IEEE802.11a/11b, HiSWANa, HiperLAN2	Wireless LAN measurement software

Features

- Wide resolution bandwidth up to 20 MHz.
- Data transmission speed approximately 10 times faster. (GPIB transmission speed: 120 kbytes/s)
- Optional measurement software (sold separately) for high-speed modulation analysis (1.5 sec. with WCDMA, 0.5 sec. with IEEE802.11a).
- Optional narrow resolution bandwidth from 1 Hz.
- Optional rubidium reference oscillator for warm-up time of just 7 minutes.
- Optional power meter that measures up to 32 GHz.

SPECTRUM MASTER MS2721A

100 kHz to 7.1 GHz



High Performance Handheld Spectrum Analyzer

NEW



The MS2721A is the first handheld spectrum analyzer to deliver the ability to measure very low level signals with a displayed average noise level of ≤ -153 dBm typical @ 1 GHz in a 10 Hz RBW. Coupled with a wide range of resolution bandwidth choices, you can configure the Spectrum Master to meet your most challenging measurement needs. As the spectrum becomes more and more congested, the ability to measure low level, closely spaced signals becomes more and more important not only for interference detection but also for wireless system planning.

Operating convenience is of paramount importance when equipment is used in the field. The input attenuation value can be tied to the reference level, reducing the number of parameters a field technician may have to set. The RBW/VBW and the span/RBW ratios can be set to values that are best for the measurements being made, further easing the technician's burden and reducing the chances of errors. Thousands of traces with names up to 15 characters long may be saved in the 64 MB non-volatile compact flash memory. These traces can later be copied into a PC using the built-in USB 2.0 connector or the 10/100 MHz Ethernet connection, or by copying them to an external Compact Flash card. The MS2721A Spectrum Master has a very wide dynamic range (>80 dB), allowing measurement of very small signals in the presence of much larger signals.

Resolution bandwidth and video bandwidth can be independently set to meet a user's measurement needs. In addition the input attenuator value can be set by the user and the preamplifier can be turned on or off as needed. For maximum flexibility, sweep triggering can be set to free run, or to do a single sweep.

Light Weight

Weighing about six pounds, including a Li-Ion battery, this fully functional handheld spectrum analyzer is light enough to take anywhere, including up a tower.

With the supplied Remote Access Software you can control an MS2721A that is miles away, seeing the screen display and operating with an interface that looks exactly like the instrument itself.

The MS2721A features eight languages (English, Spanish, German, French, Japanese, Chinese, Italian and Korean), plus two custom, user defined languages can be uploaded into the instrument using Master Software Tools, supplied with the instrument.

Fast Sweep Speed

The MS2721A can do a full span sweep in ≤ 900 milliseconds, and sweep speed in zero span can be set from less than 50 microseconds up to over 4000 seconds. This is faster and more flexible than any portable spectrum analyzer on the market today, simplifying the capture of intermittent interference signals.

+43 dBm Maximum Safe Input Level

Because the MS2721A can survive an input signal of +43 dBm – 20 watts – without damage, you can rest assured that the MS2721A can survive in even the toughest RF environments.

Spectrum Monitoring

A critical function of any spectrum analyzer is the ability to accurately view a portion of the RF and microwave spectrum. The MS2721A performs this function admirably thanks to the wide frequency range and excellent dynamic range. A built-in 64 MB compact flash memory module allows over 2000 traces to be stored. An external compact flash socket allows additional compact flash memory to expand the trace storage without limit.

Multiple Markers

Display up to six markers on screen, each with delta marker capability. In addition, you may select a marker table that simultaneously shows the status of all markers. In the table you can see the frequency and amplitude measurement value for all markers along with delta frequency and delta amplitude. Each marker can have not only a measurement reference frequency but also a delta frequency and delta amplitude, effectively giving you up to twelve markers if you need them!

Noise Markers

The capability to measure noise level in terms of dBm/Hz or dB μ V/Hz is a standard feature of the MS2721A.

Frequency Counter Markers

The MS2721A Spectrum Master has frequency counter markers with resolution to 1 Hz. Tie this capability to an external precision time base to get complementary accuracy and resolution.

Smart Measurements

The MS2721A has dedicated routines for smart measurements of field strength, channel power, occupied bandwidth, Adjacent Channel Power Ratio (ACPR) and C/I.

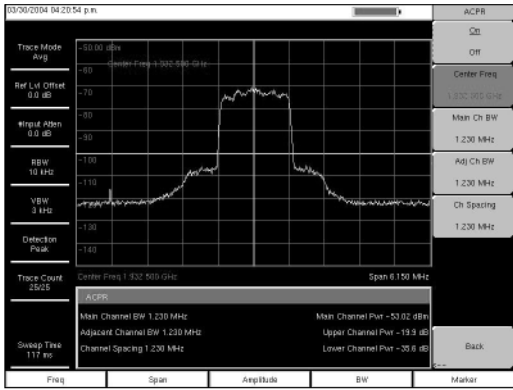

Adjacent Channel Power Ratio

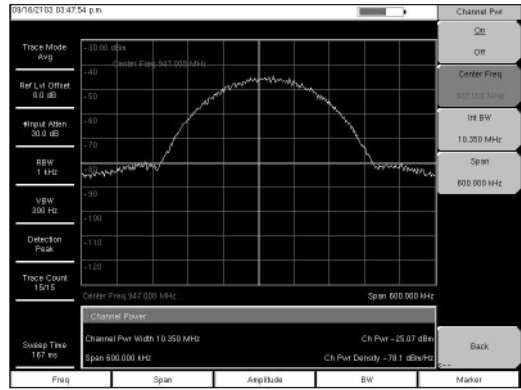

Measurement of Channel Power for a GSM Signal

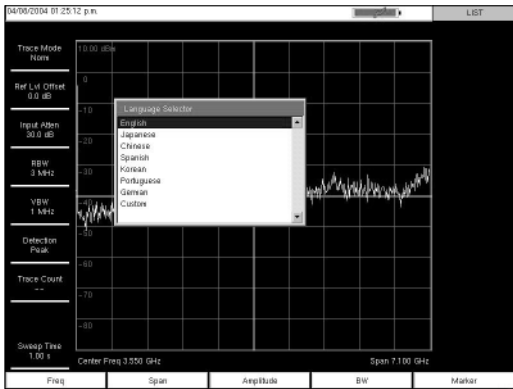

Multiple Language Support

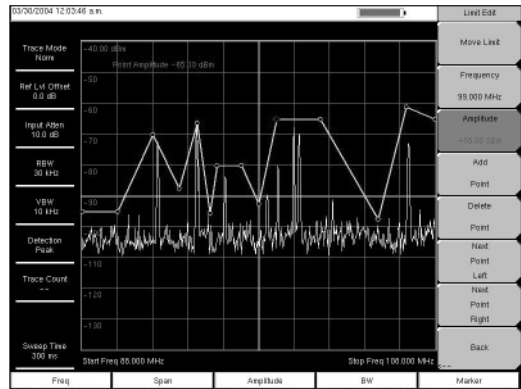

Segmented Limit Line

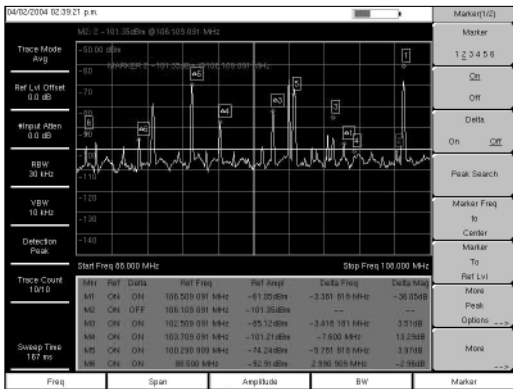

Multiple Markers plus Multiple Delta Markers

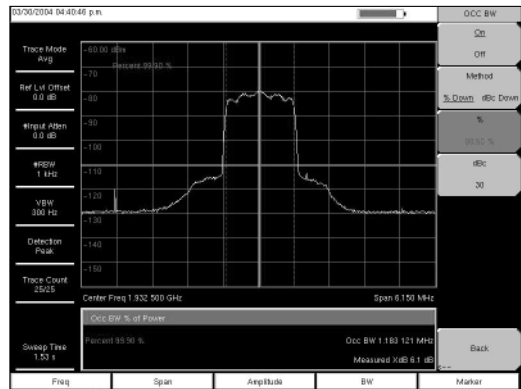

Occupied Bandwidth

WIDEBAND PEAK POWER METERS

ML2480A Series

10 MHz to 50 GHz*



For High Speed Modulated and Pulsed Power Measurements



The ML2480A series Power Meters are especially designed for accurate power measurements on high speed modulated measurements. The power meter combines advances in diode sensor technology with DSP to produce a compact and economical high speed peak power meter. A new color display is used to display the results in graphical or numerical format. The power meter incorporates features normally found in digital oscilloscopes to produce an easy to use high speed peak power meter. A high speed GPIB interface can be used for the rapid automation of the power measurement.

The ML2480A series has been designed to use the new MA2491A Wideband Sensor. The ML2480A is fully compatible with the wide range of Anritsu diode, fast thermal and universal sensors. See the section on the ML2430A Series Power Meters for more details on these sensors. Two versions of the product are available; the ML2487A Single Input unit and the ML2488A Dual Input unit.

The new MA2490A/91A wideband sensors have been designed for a variety of applications. With a selectable 5/20 MHz bandwidth, measurements can be made on the rising edges of pulsed systems as well as CDMA waveforms. The new sensors have a dynamic range of -60 dBm to +20 dBm in CW mode and a range of -25 dBm to +20 dBm in pulse modulated mode.

The new ML2480A series power meter combines the very best of high-speed measurement technology and CW stability.

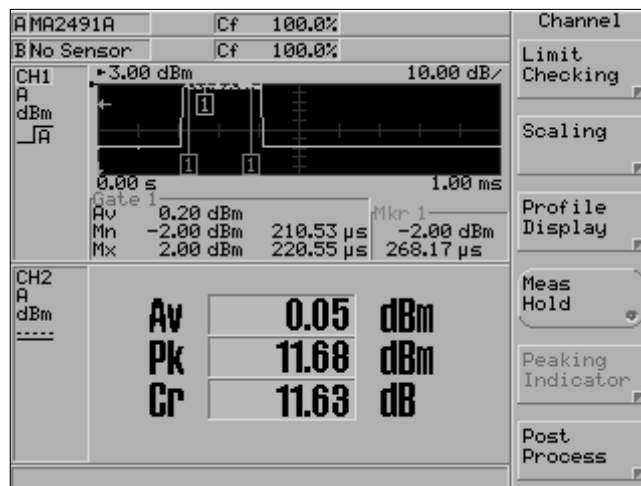
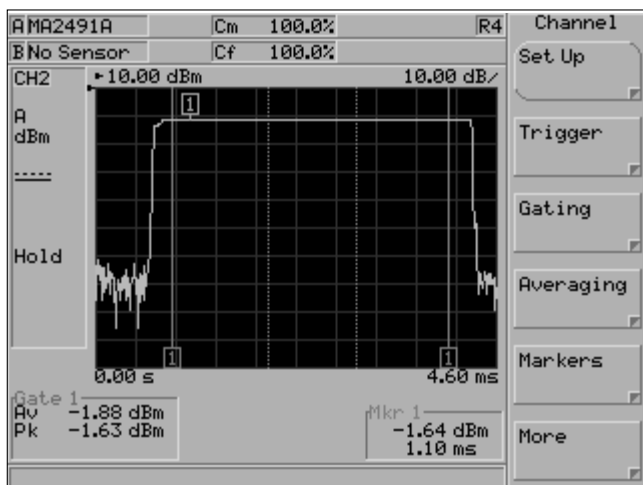

Profile or Readout Displays can be chosen

Features

• Dual Display Channel

The ML2480A series supports dual display channels. Each display channel is a measurement set up and can use any selection or combination of the sensor inputs. The instrument can be configured to view one display channel or two. The instrument can be switched between display channels quickly and simply via the CH1/CH2 "hot" key on the front panel. The user can choose to view the measurement results as a graph profile or numerical readout.

Performance

The ML2480A series has a 20 MHz signal amplifier bandwidth and a sampling rate of 64 MS/s. This makes the power meter especially suitable for measuring signals with high modulation rates such as WLAN, 3G or EDGE signals as well as providing fast rise times for examining pulsed signals such as radar.

* Frequency range is sensor dependent.

• Measurement Gates

At the heart of the new power meter's signal processing lies the measurement gate facility. The new power meter supports up to four independently set gates or eight gates repeated in a pattern. The gate allows the user to capture the relevant information from the signal under test. The wide bandwidth and high speed A/D allow the positioning of the gate very accurately within the signal profile. The user can choose between several measurements performed within the gate. Average, peak, crest, max and min are available as selections for the output.

The max and min data are time stamped so that the position of these signals is recorded within the gate and can be used to record the overshoot and undershoot of a pulsed signal.

Exclusion zones within the measurement gate are also available. Termed fences, these can be used to exclude sections of the signal from the measurement gate. Particularly useful for excluding mid-burst training sequences. Each gate has a switchable fence associated with it.

• Markers

Four independent markers are available for denoting points of interest on the signal profile. The active marker can be scrolled directly from the front panel. A delta marker can be set independently from the active marker to read the difference or the average power result. The delta marker can be linked to provide continuous scrolling through the signal.

A set of specialized automatic marker functions has been provided to ease the measurement of pulsed systems. These functions are automatic pulse rise time, pulse fall time, off time and pulse repetition interval.

• Trigger facilities

High speed measurements require precise triggering. The ML2480A series offer the following trigger modes:

Continuous, internal trigger on the rising or falling edge of either input A or input B and external TTL trigger. The external trigger allows the power meter to be synchronized to external equipment. Data collection can be delayed for a pre-determined time after the trigger point. The trigger facility incorporates a settable hold off facility which prevents the trigger from being re-armed and re-triggering on a noisy signal. A pre-trigger facility allows the capture and display of pre-trigger information on the signal.

The single shot trigger facility can be used to capture specific one off events.

• Test Limits

The ML2480A series has two different types of automatic test limits. For many applications a simple power limit can be set up to test the upper and /or lower boundaries of the signal. For pulsed systems such as RADAR, TDMA phone systems or WLAN, a time varying limit line can be set up to test all aspects of the pulse profile. The power meter can be set up to indicate pass or fail and to hold the measurement display on failure which is important when trying to track down intermittent faults. An internal limit editor enables the user to create and select their own limit profiles.

• Presets

The ML2480A series offers a number of radio system presets. Each preset configures the power meter settings to measure a radio system. GSM, GPRS, WCDMA, WLAN and Bluetooth are some of the examples of radio systems supported by this facility.

• Settings stores

The ML2480A series power meter has 20 settings stores. These provide a convenient way of having application specific measurement set ups for easy recall by the user.

• Remote Interfaces

The ML2480A series supports GPIB and RS232 as standard.

• Secure mode

The ML2480A series has a secure mode for operations in security sensitive areas. Once activated the secure mode deletes all information stored in the non-volatile RAM on power up.

Applications

• Radar

The high bandwidth and sample rate of the ML2480A series provide accurate peak measurements on a variety of RADAR, radio navigation and radio location systems.

The ML2480A series has a number of features tailored for peak power measurement on pulsed systems. The power meter can be easily set up to trigger on a pulse or sequence of pulses. Up to four independent gates can be set to measure the average, max and min powers on a sequence of pulses. The data for the max and min includes the time-stamp and gives the user an automatic display of the position and value of the maximum overshoot and minimum undershoot in each pulse. A set of automatic marker functions gives pulse rise time, fall time, off time and Pulse Repetition Interval. The Delta marker can be set up to measure the droop of the pulse top.

A single shot trigger is available to capture one-off pulse events.

The offset table function corrects the power meter reading to read the true output power when the power meter is being used with a coupler or high power attenuator in the radar test system.

• WLAN

The ML2480A series is the ideal power meter for all variants of the 802.11 WLAN specification. The 20 MHz bandwidth allows users for the first time to get an accurate peak power reading without having to resort to manual correction of the peak reading due to bandwidth limitations. The wide bandwidth of the signal channel allows for the accurate placement of the gate to measure precise selections of the signal such as the OFDM training sequence at the start of the 802.11g signal.

• GSM/EDGE/GPRS

The graphical display and the measurement gates make the measurement of GSM and PCS systems straightforward.

The ML2480A series power meter is set up to trigger on the GSM pulse. The active gate is set up to measure the power within the 10% to 90% section of the burst profile. An automatic limit can be used to give pass or fail indication. The display shows the results from the active gate, indicating the average power within the burst.

GPRS and GSM test modes can be tested easily with the use of the multiple gates. A GSM gate pattern can be repeated up to eight times to allow the power meter to capture and read back the power from each of the slots, giving up to eight simultaneous measurements. EDGE measurements are quick and simple to make. The high sample rate leads to improved settling time and the use of the trigger hold off facility prevents re-triggering on the symbol transitions. PHS and IS-136 systems can also be measured effectively and quickly in this way.

• 3G-CDMA

The ML2480A series has been designed to measure the peak power of all the major CDMA systems in the world including those that use Time Division Duplexing such as TD-SCDMA. The display can be configured to measure Average, Peak and Crest Factor. The measurement period can be set for accurate results. TDD systems can be displayed as a graph profile and the measurement gates can be set to measure and display the peak and crest factor during the transmission. CCDF, CDF and PDF statistical functions are supported on the CDMA measurements and enable the designers of power amplifiers to correctly estimate the margins on the peak power handling capabilities of the amplifiers.

• Amplifier and Return Loss Measurements

Use the dual input ML2488A to measure the gain or the return loss of an amplifier under its correct operating conditions. Power amplifiers designed for peak applications, whether pulsed or CDMA, cannot operate at full peak power with CW test inputs. The gain and output power can only be measured accurately using a peak power meter under representative conditions. The return loss of amplifiers and other devices can only be evaluated under high power pulsed conditions with a peak power meter connected to a high directivity coupler.

• MA2490A and MA2491A Wideband Sensors

The MA2490 series sensors are wideband sensors suitable for pulse and CDMA applications. They have a selectable 5/20 MHz bandwidth. The MA2490A covers the range 50 MHz to 8 GHz and the MA2491A extends the range to 18 GHz. Rise time on this sensor is 18 ns. The sensor incorporates a 'chopper' which extends the RMS measurement range to -60 dBm. Upper limit is +20 dBm.

• MA2411A Pulse Sensor

The MA2411A Pulse sensor is specifically designed for fast measurements on pulsed systems. The bandwidth of this sensor is 50 MHz and has a rise time of 8 ns. This sensor covers the frequency range 300 MHz to 40 GHz. Requires 1 GHz Calibrator option ML2400A/15.

POWER METERS

ML2400A/2430A Series



For Measuring Wide Dynamic Range Power



The ML2430A series Power Meters combine the advantages of thermal meter accuracy, diode meter speed, and peak power meter display graphics. The result is a single instrument that achieves 90 dB dynamic range with a single sensor. The ML2430A series includes graphics display capability as a standard feature. The ruggedized housing and optional high-capacity NiMH battery bring convenience and accuracy to field service applications.

Performance

• Speed and dynamic range

The 90 dB range MA2470A series Power Sensors' high sensitivity reaches stable power readings to -70 dBm. 35 kHz sample rates profile cellular, PCS, and other pulsed signals to 0.1 μ sec resolution. Modern connector technology achieves industry-leading return loss for improved accuracy through 50 GHz. The 87 dB range MA2440A series High Accuracy Sensors further improve return loss performance by adding a matching circuit to the MA2470A series' front end.



New power sensor technology achieves industry leading measurement linearity and high sensitivity.

• Universal power sensors

The new MA2480A series Universal Power Sensor will measure any modulated or multi-tone signal thanks to a patented sensor architecture with three diode pairs. Universal power sensors deliver over 80 dB of dynamic range with speed and accuracy.

Average power measurements on WCDMA signals can now be made without the need for special power meters. Universal sensors are also ideal for power measurements on other digitally modulated carriers such as HDTV, DAB or QAM modulated radio links.

The sensor architecture ensures that one of the diode pairs is always operating in its square law region. The meter selects the diode pair operating in its square law region and is designed so that even the peaks of CDMA signals are measured accurately. Anritsu's three stage diode pair approach leads to a very much faster measurement time than the two stage approach used in previous generations of average power sensors. No slowing of measurement speed is observed at switching points, making them transparent to the user.

Universal power sensors are also ideal for applications where multiple signals are present, such as intermodulation measurements and satellite multi carrier power loading measurements.

A unique additional capability of the Anritsu Universal power sensor is the ability to use it as a standard diode sensor for fast CW measurements and pulse or TDMA measurements. In this mode the fast response of diode sensors is maintained across the full dynamic range of the sensor, meaning that for the majority of users it is the only sensor that they will ever need - a truly Universal Power Sensor.

• Fast thermal sensors

Anritsu's latest semiconductor processing technology produces thermal power sensors with speed increased by an order of magnitude. Improvements in connector technology reduce measurement mismatch uncertainty through 50 GHz to levels previously attained only to 20 GHz. The fabrication technique, as well as the ML2430A's sampling and DSP technology, optimize measuring speed to 4 ms rise and fall times.

• GPIB speed

Industry leading speed of >600 continuous readings per second is achieved under a variety of operating conditions including averaging settings, sensor control settings, triggering conditions, operating mode, sensor type, and GPIB interface manufacturer. The ML2430A series offers the ability to measure and transfer a high-speed burst of 200 data points using profile operating mode with sampling rates of 35k per second.

• GPIB emulation

With 99.9% emulation of older meters, the ML2430A series improves ATE system productivity. Typical test system speed improvement is 2 to 10 times faster system speed depending upon the number of measurements taken during the test, the minimal use of wait statements within the code, and the meter model emulated.

• Triggering controls

What use is high speed without triggering and sample controls? Data acquisition event arming and triggering functions traditionally found on expensive peak power meters are standard in the ML2430A series. Triggering delay and the sample integration time per reading can be directly controlled by the operator. Trigger sources include, continuous, internal, external TTL, and manual. Thus, data acquisition can be optimally controlled for synchronization with other test equipment.

• Burst profile graphics display

The ML2430A features random repetitive sampling for high resolution of fast signals. A time domain graphic display profiles pulsed signals over a power range of -40 dBm to +20 dBm. 35 kHz sampling speed produces clear power profiles of cellular and PCS signals including TDMA, PHS, GSM, and DCS-1800. Pulse top power is easily and repeatably measured using between cursor averaging. Measure pulse-top power over >80 dB dynamic range in readout mode at GPIB speeds >200 readings per second.

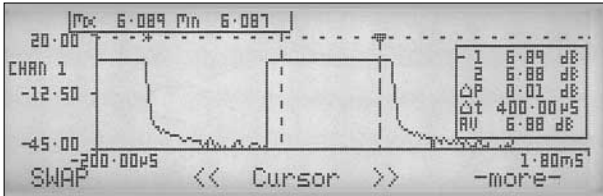

• Power vs. time graphics display

The power versus time mode is a strip chart style display for monitoring gain and output power variations over time/temperature, supply voltage, or a component tolerance. In service applications, measurement of power versus time aids trouble shooting of unusual conditions, such as intermittent switches or abnormal power control in a mobile telephone base stations. The power versus time mode provides a clear strip chart display of RF power variation.

• Source sweep graphic display

Power Sweep or frequency sweep data are acquired at more than 10 sweeps per second over GPIB. Synchronization with synthesizers requires connection (BNC) of a 0.0 V sweep ramp input and an RF blanking/dwell input.

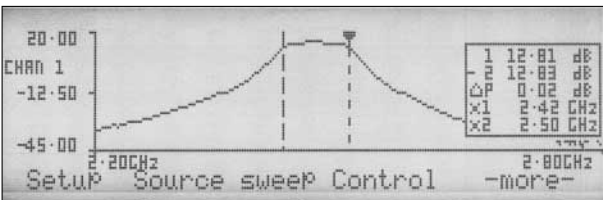

• Parallel printer connector

Many deskjet series printers can be connected directly to the ML2430A for fast documentation of performance on the bench or in the field. Meter calibration, triggering, and averaging settings are listed with the display printout. Thus, evidence of DUT (device under test) anomalies can be duplicated quickly.

• 90 dB dynamic range

Typical communications industry ATE systems operate over a 60 to 80 dB dynamic range. The MA2470A series' 90 dB dynamic range replaces two 50 dB sensors. Furthermore, an RF switch is no longer needed for the two sensors. This reduces software control complexity and further speeds test execution.

• Sensor EEPROM

All MA2400A series sensors are equipped with internal EEPROMs for storage of calibration factor data vs. frequency. This allows the power meter to interpolate and correct readings automatically, improving accuracy and convenience.

• High reliability

A rugged polycarbonate chassis handles drop shocks and rough field treatment. The absence of vent holes makes the meter splash resistant. A front cover panel and softcase are optional for further environmental protection. Power sensors are also ruggedized for rough handling.

• Improved accuracy

Mismatch uncertainty is typically the largest source of error. The MA2400A series Power Sensors offer a typical 5 to 6 dB improvement in sensor return loss, typically cutting mismatch uncertainty in half. The MA2440A series High Accuracy Sensors incorporate a matching pad which further improves return loss by 5 to 6 dB — again halving mismatch uncertainty.

• Offset table for path loss correction

Compensating for the true frequency response of attenuators, couplers, cables, switches, and other test setup devices improves measurement accuracy. For this reason, the ML2430A series can apply an offset table of attenuation-versus-frequency in addition to the traditional fixed dB offset capability. When a power sensor connection is preceded with a new 1N series wideband power limiter, the offset table compensates for frequency response. Thus, the combination achieves an accurate, "burnout-proof" sensor.

• Softkey menu control

Softkey menus simplify instrument control by making the user interface easier to understand. The numerical keypad simplifies the operator interface.

• Battery

The optional NiMH "Smart" battery supports high charge density for a typical 8 hour day of operation. Accurate fuel gauging, <2 hour fast charge cycling, and the elimination of NiCd style memory effect further enhance the convenience of this battery technology.

• Voltmeter

The ML2430A series also supports high-speed voltage measurement. A rear panel BNC measures voltage or operates as V/GHz input supporting automated sensor calibration factor correction.

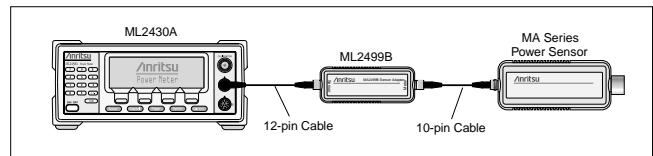

• Sensor Adapter, MA2499B

The ML2499B Sensor Adapter operates with older (10-pin) MA Series Power Sensors. An internal EEPROM allows storage of up to 9 sets of sensor calibration factor tables. Each table is individually selectable from the sensor menu. MP series waveguide power sensors are also compatible when used with the MA4002A adapter.

• High power applications

Traditional high power sensors are expensive and have degraded accuracy specifications. Further, their annual calibration requires more time and expense. Anritsu's new User Calibration Factor Tables avoid these problems. Any attenuator or coupler can be compensated by entering frequency and attenuation values into the MA2400A Series Power Sensors internal EEPROM. The attenuation device can be semi-permanently attached; the power meter automatically applies compensation during the 0.0 dBm, 50 MHz calibration reference process. The User Calibration Factor Tables are easily deactivated — allowing the power sensor to be used stand-alone also.

• Remote monitoring by telephone

Monitor transmitter performance remotely with standard telephone lines using the ML2430A's full duplex RS232 and dial-out capabilities. When the ML2430A detects a high or low limit line violation, it will automatically dial a phone number. The meter's data acquisition settings can adjust to monitor average power or the burst power of specific timeslots. The RS232 port uses the same commands as the GPIB. Contact your Anritsu representative for PC compatible software.

• Locate power sensors remotely

Some power meter applications require the sensor and meter to be separated by long distances or physical barriers. There is no requirement to perform a 0.0 dBm reference with the power meter; however, the lack of a reference may cause a small offset error. When a reference is desired, the MA2418A Reference Oscillator (0.0 dBm, 50 MHz) provides a convenient solution. DC power supply, and small size allows the MA2418A to be embedded in switch matrices or other enclosures. When a power sensor's cable must pass through walls or shielded enclosures, the ML2400A/29 Bulkhead Adapter provides a convenient connection between two sensor cables.

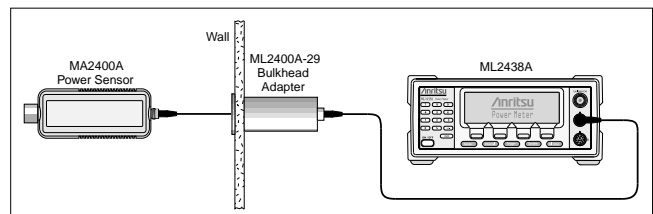



• N-CDMA Power Measurements

The Anritsu ML2407A power meter and MA2460B/C series power sensor have been specifically designed to make the exacting measurements required on N-CDMA signals. Today's digital radio standards employ a variety of techniques to enhance performance and increase spectral efficiency. Application of Code Division Multiple Access (CDMA) technology enables multiple users to share the same spectrum, with a channel bandwidth of 1.2288 MHz. Having a much wider channel bandwidth than earlier generation analog or TDMA systems has created new challenges for radio and component equipment manufacturers.

The Anritsu MA2460B/C series power sensor has a video bandwidth of 1.25 MHz. When used with the ML2407A (single channel) or ML2408A (dual channel) power meters, it is able to correctly characterize IS-95 waveforms and accurately measure average power. Advanced signal processing with fast sampling speeds facilitate measurements of peak power and crest factor.

The dual diode MA2460B/C series power sensor is both fast and accurate. It delivers over 80 dBs of dynamic range, making it suitable for both open and closed loop power control testing. A built-in EEPROM automates sensor calibration factor correction to simplify test set up and reduce human error.

EEPROM correction also corrects for sensor linearity across a range of temperatures, providing test engineers with unmatched measurement accuracy under all operating conditions.



• Power Meter ML2407A

For automated measurements under GPIB control, the ML2407A power meter offers many class-leading features. Over 600 readings per second are available in fast mode, reducing total test time. Programmers have control over low-level averaging, sensor setting, and noise reduction for optimization of program speed. The sensors internal AC detection circuitry delivers a guaranteed noise floor of -60 dBm with typical performance to -70 dBm, even when measuring CDMA signals.

When testing transmitters and amplifiers it is often necessary to measure crest factor. If an amplifier is unable to cope with the peaks within the signal they will be attenuated and information lost.

Amplifiers are often tested across a range of average powers to ensure that the crest factor is maintained. This provides a simple way of ensuring that the amplifier is maintaining linearity across its full dynamic range. The Anritsu ML2407A facilitates tuning of amplifiers through the use of a crest factor time window. The period of time for which a peak will be stored is set by the user. Thus the change in crest factor can be monitored as the average power into an amplifier is increased.

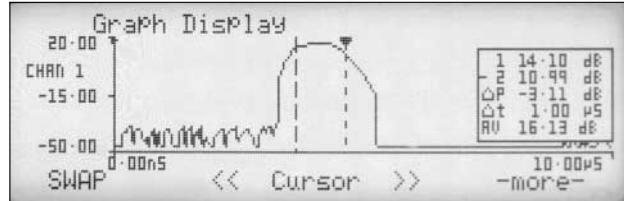

• Fast Pulse Analysis

The MA2460B/C series sensor also benefits from improved pulse response times. Pulses down to 1 μs can now be captured and displayed thanks to a sensor rise time of 0.6 μs. It is becoming increasingly common for amplifiers to be tested by analyzing their responses to short pulses. The ML2407A in profile mode can graphically display the pulse shape. Two cursors can be positioned on the trace and cursor readouts show the power at each cursor position plus the average power between the cursors.

Triggering for pulse analysis is from a TTL input or from a rising or falling edge. Variable trigger delay provides the ability to view the whole pulse profile or exactly the portion of the pulse of interest. With the ML2408A dual channel power meter, the pulsed gain of an amplifier can be measured directly.

• PowerSuite

PowerSuite software runs on a standard PC running Windows® 95 (or higher). PowerSuite adds the following measurements to the capability of the Anritsu ML2400A series power meters:

- Statistical power analysis
 - Probability Density Function (PDF)
 - Cumulative Density Function (CDF)
 - Inverse Cumulative Function (1-CDF)
- Pulse characterization (pulse width, rise time, peak power, pulse power, overshoot repetition, and period)
- GSM (and other TDMA) time slot power analysis
- Automated amplifier compression analysis
 - Single frequency compression
 - Compression vs frequency

Statistical analysis of power distribution can reveal important information to optimize CDMA system design. PDF displays the percentage of time (or samples) that the power is at a specific value. CDF takes the same data but displays the percentage of time (or samples) that the power is at or below a specific value. Analyzing this data can reveal how a system or device may be distorting the signal that it is transmitting. Comparison of the CDF plots from an amplifier at differing average power levels validates linearity and reveals the potential introduction of data errors.

PowerSuite is a very flexible package that provides full user control over measurement settings. The screen can be set for continuous update so that changes to the device or system under test can be viewed instantly. Alternatively plots can be archived for later analysis.

BROADBAND AND MILLIMETER WAVE VECTOR NETWORK ANALYZER ME7808B

40 MHz to 110 GHz (expandable to 325 GHz)



Broadband S-Parameter Measurements to 110 GHz and Beyond

NEW



The ME7808B Broadband Vector Network Analyzer (VNA) is a high performance measurement solution that covers 40 MHz to 110 GHz in a single fast sweep. Built on the advanced technology of the Lightning 65 GHz VNA, the ME7808B is ideal for making accurate S-parameter measurements of components and devices to 110 GHz. The flexible system architecture of the ME7808B makes it easy to adapt to multiple measurement applications.

An alternate configuration is the ME7808B Millimeter Wave VNA, a high performance measurement solution that covers specific millimeter wave bands from 50 GHz to 325 GHz. Any of the two-port Lightning 37000D VNA models can be used as the foundation for the Millimeter Wave VNA.

The ME7808B Broadband VNA consists of:

- Lightning 37397D 65 GHz VNA
- Two Millimeter Wave Modules (3742A Series)
 - Extended W Band (WR-10), 65 to 110 GHz
- Broadband Test Set
- Two 20 GHz Ultra-Low Phase Noise Frequency Sources
- Two Multiplexing Couplers
- Equipment Console with Table

The ME7808B Millimeter Wave VNA consists of:

- Any Lightning 37200D or 37300D series VNA
- Two Millimeter Wave Modules (3740A or 3741A Series)
 - V Band (WR-15), 50 to 75 GHz
 - E Band (WR-12), 60 to 90 GHz
 - Extended E Band (WR-12), 56 to 94 GHz
 - W Band (WR-10), 75 to 110 GHz
 - Extended W Band (WR-10), 65 to 110 GHz
 - Higher frequency bands (up to 325 GHz)*
- Broadband Test Set
- Two 20 GHz Ultra-Low Phase Noise Frequency Sources
- Equipment Console with Table

* with VNA2 Frequency Extension Modules from OML, Inc.

Features

• Ultra-Low Phase Noise Frequency Sources

The ME7808B Broadband and Millimeter Wave VNAs use two 20 GHz synthesized sources with ultra low phase noise (Option 3). They provide the LO and RF drive to the mmW modules which translates to the lowest measurement trace noise available in a millimeter wave VNA.

• Single Pair of Coaxial Test Ports For Broadband Sweep

The ME7808B Broadband VNA combines the 40 MHz to 65 GHz output from the VNA and the 65 GHz to 110 GHz output from the mmW modules using a unique multiplexing coupler design. The effective system test ports for the broadband configuration are therefore two W1 coax connectors. The W1 Connector™ is compliant with the IEEE standard 1.0 mm connector. This design provides a DC path that permits bias injection from the VNA front panel bias inputs directly to the W1 coax test ports.

• Up to Three Systems in One

Using the approach of coupling the 65 GHz VNA output with that from the mmW modules, the ME7808B Broadband VNA can be operated in any of the following configurations:

- 1) as a broadband VNA (40 MHz to 110 GHz) with W1 Connector™ coaxial interface
- 2) as a stand-alone 65 GHz VNA with V Connector® coaxial interface
- 3) as a millimeter wave VNA (65 GHz to 110 GHz) with a WR-10 waveguide connector interface. Additional discrete mmW bands are easily supported by substituting other available mmW modules into the system.

The ME7808B Millimeter Wave VNA permits switching between the stand-alone coaxial and the millimeter wave modes, thus offering two systems in one.

Reconfiguration of the system is fast and simple using an internal software menu. When operating either the stand-alone VNA or mmW systems independently, higher output power and increased dynamic range are achievable. Wafer probe tips can be connected to any of the three interfaces to make on-wafer measurements.

• Complete Measurement Solutions

The ME7808B is compatible with leading probe stations and probe tips for making on-wafer measurements. On-wafer calibration software such as SussCal from Suss MicroTec and WinCal from Cascade Microtech have built in drivers for the Anritsu Lightning VNAs. For parameter extraction and device modeling, an instrument driver for the ME7808B is integrated in Agilent EEsof's IC-CAP 2002. In addition, a complete list of accessories is available including W1 coaxial calibration kits, waveguide calibration kits, W1 coaxial and waveguide to coaxial adapters.

MICROWAVE VECTOR NETWORK ANALYZERS

37000D Series

40 MHz to 65 GHz

Ethernet  GPIB

For Fast and Accurate S-Parameter Measurements

NEW



The Lightning D-Series Vector Network Analyzers (VNAs) are high performance test tools designed to satisfy the growing needs of defense, satellite, radar, broadband communication, and high speed component markets. The new 37000D VNAs improve upon performance while providing a wider set of standard application features to better suit the needs of R&D engineers working on next generation designs. These new features, when combined with the ease of programming through helpful software utilities and faster data transfer over Ethernet, make it an equally valuable tool for manufacturing as well.

The Lightning D-Series consists of two primary configurations built for R&D and Production applications:

Premium Models (37300D)

The Premium series are designed for active and passive device applications, where versatility is the main priority. These are high performance two-port VNAs that include step attenuators, internal bias tees, a gain compression application and wider power range as standard features. They are available in four different frequency ranges; 20 (37347D), 40 (37369D), 50 (37377D) and 65 (37397D) GHz. Each one of them can be configured as an ME7808B millimeter wave VNA by simply adding a broadband test set, two synthesizers and the desired millimeter wave modules. The 37397D is also directly upgradeable to an ME7808B Broadband VNA with single sweep coverage from 40 MHz to 110 GHz.

Economy Models (37200D)

The Economy series are basic two-port VNAs designed for passive applications. They are available in four different frequency ranges; 20 (37247D), 40 (37269D), 50 (37277D) and 65 (37297D) GHz. Each one of them can be configured as an Economy millimeter wave VNA by simply adding a broadband test set, two synthesizers and the desired mmW modules.

The 37300D Premium models include:

- Multiple Source Control and Frequency Offset
- E/O and O/E Application
- Gain Compression Application
- Internal Bias Tees
- Extended Power Range (Source Step Attenuator and Receiver Step Attenuator)
- Rear Panel IF Inputs (for upgrade to Millimeter Wave)
- NxN calibration Utility for Mixer Measurements
- Embed/De-Embed application
- High Stability Frequency Reference
- 1 Hz Frequency Resolution

The 37200D Economy models include:

- Multiple Source Control and Frequency Offset
- E/O and O/E Application
- Rear Panel IF Inputs (for upgrade to Millimeter Wave)
- NxN calibration Utility for Mixer Measurements
- Embed/De-Embed application
- High Stability Frequency Reference
- 1 Hz Frequency Resolution

Features**• High speed data transfer and control**

For maximum efficiency, an Ethernet connection and dual GPIB ports are standard on every 37000D VNA. Ethernet connection provides high speed data transfers and remote data extraction from the VNA. The same can also be achieved via the standard GPIB interface. The second GPIB port is dedicated to control of peripheral devices such as plotters, power meters, and frequency synthesizers. The 37000D series maximize throughput by combining fast, error-corrected sweeps with high-speed data transfers.

• Time domain analysis (Option 2A)

Analyze impedance discontinuities as a function of time or distance with the 37000D's high-speed time domain. Isolate individual reflections in time and evaluate their effects in the frequency domain. Remove the effects of device packages and fixturing with time domain gating to see the actual performance of your designs. Use the independent display channels to view the response of your designs before, during, and after time domain processing.

The software provides four different windowing functions to optimize dynamic range and resolution. The exclusive phasor impulse mode will show you the true impedance characteristics of mismatches in waveguide, microstrip, and other band-limited media.

• Multiple source control and set-on receiver mode

The frequency of two sources and a receiver can be controlled without the need for an external controller using this function. Independently specify the sweep ranges and output powers of the sources and the sweep range of the receiver to accommodate mixer, swept IMD, TOI, and harmonic measurements. The 37000D's set-on receiver mode allows it to operate as a tuned receiver by phase locking all of its local oscillators to its internal crystal reference oscillator.

- **Software tools and compatibility**

VNA Utilities, provided with every 37000D, is the ultimate solution for automated test software development. It includes fully functional application programs, re-usable calibration, set-up and data manipulation samples, and software development tools for creating custom applications. VNA Utilities includes applications such as the Capture Utility, which allows the user to extract data from the VNA in any of the supported formats (bitmap, S2P, plotter graphics, etc.).

The Calkit File Maker helps create a custom calibration kit disk from the coefficients entered by the user. And the VNA File Utility manages system software downloads and data file uploads to/from the VNA's hard disk via a PC. VNA Utilities also includes drivers and help tools for various software environments such as Visual Basic®, Labview and others.

- **NxN calibration utility**

This application is used for making error-corrected measurements of frequency translating devices such as mixers. The calibration performed requires a three mixer combination to correct for the components in the measurement path. Any one of the mixers characterized can then be used for the measurement of the DUT mixer. The standard built-in application guides the user through the set up and the calibration.

- **Embedding/De-embedding**

The de-embedding function is used for removal of test fixture contributions and other networks from measurements. The embedding function can be used to simulate matching circuits for optimizing amplifier and other designs.

- **Internally controlled AutoCal®**

One source of potential errors and inaccuracies in any network analyzer system is the calibration of that system. The Anritsu AutoCal automatic calibrator is designed to speed and simplify the calibration of your 37000D VNA. Using the built-in software support and an AutoCal module connected to the serial port on the rear panel of the instrument, you are ready to make fast, accurate, and repeatable calibrations.

- **Built-in mass storage**

Testing devices with multiple setups is now easier. A built-in hard disk drive rapidly stores and recalls frequently used front panel setups and calibrations. Store your complete test setup including limit lines and frequency markers. Create descriptive file names to assist multiple users or device types. The high storage capability of the internal hard disk means there is space for literally hundreds of calibrations, front panel setups, and data traces. In secure environments, the internal hard disk can be removed (Option 4A) and either an external drive on the SCSI port or the internal 1.44 MB floppy drive can be used for uploading proprietary setups.

- **Flexible test set (Option 15)**

All 37000D VNAs can be configured with six front panel loops: four direct receiver access loops and two auxiliary source loops (one for each port). These are useful for measurements of mixers, antennas, as well as integration with external test sets (for example, multi-port).

- **Upgradeability**

The 37000D series analyzers are designed to accommodate higher frequency ranges and more powerful features as your requirements grow. Any 37000D series VNA can be upgraded to any other model in the instrument family to fit your changing requirements. In addition, any VNA can also be upgraded to the ME7808B Broadband and Millimeter Wave VNA. This provides a cost-effective approach to satisfying today's needs while providing the flexibility to meet tomorrow's demands. System software upgrades are easily performed by loading software through the floppy drive or GPIB.

- **Three-year factory warranty**

All 37000D series VNAs are backed with a no-questions-asked three-year warranty.

Applications

- **Filters**

The 37000D VNAs have built-in functions that automatically locate filter center frequency, 3 dB bandwidth, max/min insertion loss, Q, and shape factor. The analyzer's improved dynamic range can be used to measure filter rejection and input match on the same display. Sweep speed can be enhanced for tuning filters by using the instrument's tune mode. This unique feature helps users optimize sweep times in one direction for better hand-to-eye tuning while maintaining a 12-term corrected S-parameter display. The analyzer's tune mode maximizes sweep speed and accuracy, simultaneously, by allowing the user to choose when reverse parameters are updated.

Also, passband phase distortions can be measured with the automatic reference plane extension capability. A single key press can help quickly identify filter non-linear phase responses.

- **Swept Power Gain Compression - Amplifiers (37300D models only)**

The Swept Power Gain Compression application (standard on 37300D models) allows the user to easily measure amplifier gain compression vs. input power or frequency. Power meter assisted linearity and flat output power calibration, combined with a receiver port calibration, provides capability to measure output power in dBm. A 1 watt, 70 dB (60 dB on >40 GHz models) step attenuator in the port 1 path, and a 40 dB step attenuator in the port 2 path, coupled with 20 dB ALC range, give complete control to characterize virtually any amplifier. This range is reduced to 12 dB at frequencies >50 GHz. Internal bias tees simplify DC biasing of your active designs.

In addition, a front panel source loop on each port (option 15) allows external amplifier insertion, increasing port power up to 1 Watt maximum for high input power amplifiers.

- **Mixers**

Complex frequency translated device measurements such as error corrected conversion loss, group delay, and port match measurements of mixers and up/downconverters are simplified with the NxN mixer measurement application. The NxN application adjusts the VNA's 12-term calibration for the reference mixer, a Band Pass Filter, and attenuators used in the measurement setup, yielding accurate measurements of the frequency translated DUT.

- **Multi-Port and Balanced/Differential**

Single-ended and mixed-mode S-parameter measurements with the 37000D series VNA are accomplished using a multi-port test set and an external PC running the Navigator™ Multi-Port software. Multi-Port components (diplexers, couplers, power dividers, etc.) or balanced/differential components can be easily characterized to frequencies as high as 65 GHz.

- **Microstrip devices**

The 37000D series offers complete substrate measurement solutions for both microstrip and coplanar waveguide (CPW) designs. The 37000D series analyzers accommodate the model 3680 series Universal Test Fixtures (UTF), calibration kits, and verification kits. Guaranteed system specifications provide assurance that your test results are accurate and verifiable. Internal calibration routines such as the Line-Reflect-Line (LRL) and Line-Reflect-Match (LRM) calibration capability help completely characterize connectorless devices with the Lightning VNAs. The four channel design provides true LRL/LRM error-correction yielding the highest performance available for in-fixture measurements. Highly reflective devices, along with well matched ones can also be measured with the same degree of ease. Automatic dispersion compensation improves measurement accuracy to help determine phase distortions for all microstrip designs.

- **E/O and O/E devices**

The 37000D series incorporates an E/O and O/E measurement application that simplifies VNA calibration when measuring E/O and O/E devices. The transfer function, group delay, and return loss of optical modulators (E/O) and photoreceivers (O/E) can be easily characterized using this application. An O/E calibration module (MN4765A) and a laser source are required to complete the test setup. The internal VNA application de-embeds the response of the O/E calibration module to allow direct measurement of the modulator. For O/E measurements, the O/E calibration module is used to characterize a modulator first, which is then used as the characterized reference to measure another photoreceiver.

- **Antennas**

All 37000D VNAs include rear panel IF inputs (<270 MHz) that can be used in remote mixing applications to make antenna measurements. For near field and far field measurements that require direct access to the VNA test and reference channels, Option 15 can be included on any 37000D VNA which adds the four test and reference loops on the front panel to simplify measurements.

In addition the VNAs Fast CW mode enhances data extraction over GPIB to rates of 0.8 ms/point using internal triggering, and 1.2 ms/point with external triggering or 1.5 ms/point with GPIB triggering, allowing for fast data extraction for accurate plotting of near and far field effects.

MICROWAVE MULTI-PORT BALANCED VNA
37000D Series
 40 MHz to 65 GHz



For Single-Ended, Balanced-Differential and Mixed-Mode S-Parameter Measurements

NEW



The Microwave Multi-Port Balanced VNA consists of a 37000D Lightning VNA, a multi-port test set, and the Navigator™ Multi-Port software (external PC is required and is not included). The multi-port test set is a 2x4 switch matrix that allows either port on the VNA to connect with any of the 4 ports on the test set. The easy-to-use Navigator™ Multi-Port software provides full step-by-step direction, simplifying calibration, and speeding measurement throughput. Existing Lightning VNAs can be readily upgraded to add the new multi-port test set and software. With the Lightning VNA's proven stability, the Multi-Port Balanced VNA provides excellent measurement repeatability and offers a cost-effective application solution for microwave multi-port device characterization.

Features

- Unparalleled flexibility to perform any 2, 3, or 4-port, single-ended and mixed-mode S-parameter measurements to 65 GHz
- Characterize passive multi-port components, like couplers, diplexers, power dividers
- Measure balanced/differential components and circuits
- Evaluate two 2-port (or four 1-port) devices simultaneously
- Full 4-port calibrations provide superior accuracy (SOLT, LRL, and LRM)
- Supports entry of calibration coefficients and parameters for on-wafer measurements
- Embed/de-embed S2P files and transmission line structures
- Impedance transformation (real and complex)
- Manual test set and calibration control is available
- Powerful Navigator™ Multi-Port software simplifies calibrations and measurements

Easy-to-Use Navigator™ Multi-Port Software

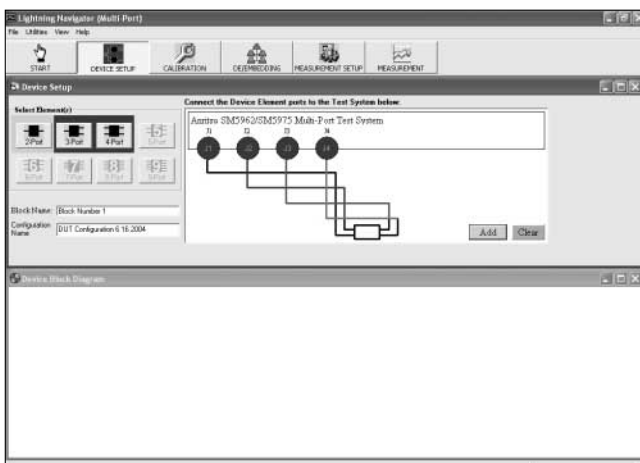

Device Setup



Calibration

Easy-to-Use Navigator™ Multi-Port Software

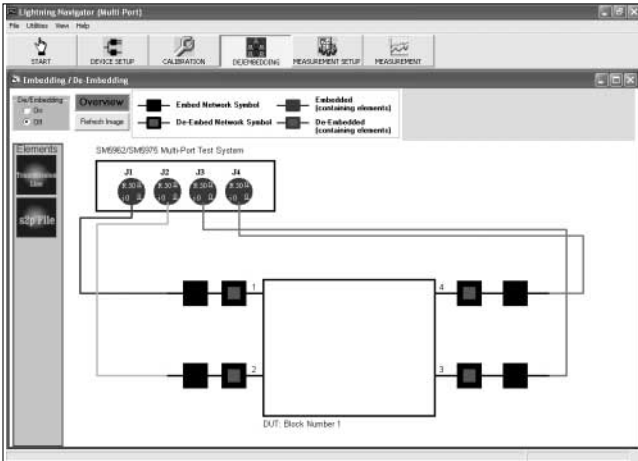

Embedding/De-Embedding

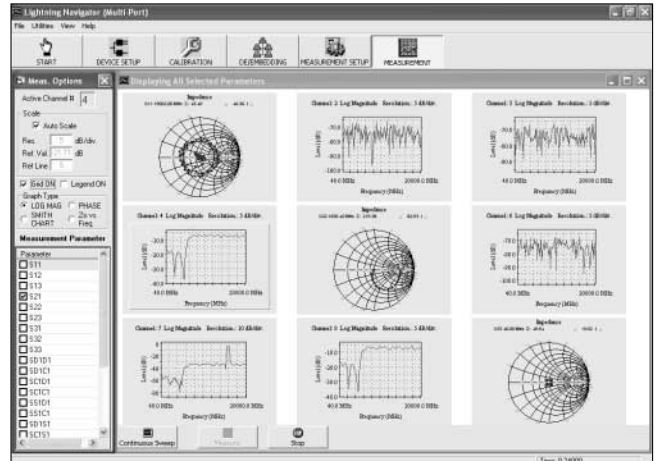

Measurement

VECTOR NETWORK MEASUREMENT SYSTEMS (VNMS)

Ethernet / GPIB

MS4622A/B/D, MS4623A/B/D, MS4624A/B/D

10 MHz to 3 GHz

10 MHz to 6 GHz

10 MHz to 9 GHz

Innovative Manufacturing Solutions for Measuring S-Parameters, NF, P_{1dB}, IMD, and 3 and 4-Port Devices



Anritsu's family of RF Vector Network Measurement Systems include the MS462XA, MS462XB, and the new MS462xD. Code named Scorpion®, the MS462XX line is much more capable than traditional VNAs. With Scorpion's all new measurement options of vector error-corrected Noise Figure, Intermodulation Distortion, Fourth Measurement Port, and Harmonics, they create a total test solution. When you add the standard benefits of outstanding dynamic range and blazing fast measurement speed, you have a truly innovative solution for a manufacturing test environment!

Key Benefits

- See the true performance of all your passive and active components including antennas, isolators, filters, duplexers, couplers, SAW filters, baluns, amplifiers, mixers, and multi-port components
- With a single connection perform S-parameter, Harmonics, Time Domain, Compression, Intermodulation Distortion (IMD), Noise Figure (NF), and Frequency Translated Group Delay for accurate and thorough device characterization
- Optimized for your manufacturing process with features like 2 & 4 port AutoCal® modules which simplify calibrations, sequences for automating repetitive keystrokes, enhanced markers simplify data collection, and external SCSI interface for massive storage
- Measurement speeds of 150 µsec/point and dynamic range of 125 dB

Scorpion's AutoCal® feature also provides the capability to achieve fast, accurate, and highly repeatable calibrations without the need for an external controller. By using AutoCal® standard connector types or test port cable converters, you can calibrate directly using Type N, K, 3.5 mm, or SMA connectors. Planned upgrades include adapter characterization with the ability to calibrate using 7/16 or TNC type connectors.

• 4-Port Balance/Differential Measurements

The MS462xD series of Vector Network Measurement Systems (VNMS) allow you to characterize devices like SAW filters and integrated circuits using powerful features like mixed-mode S-parameters, embedding/de-embedding, and arbitrary impedance. De-embedding utilities provide compensation techniques for typical test fixture environments to further enhance the measurement accuracy, while integrated embedding utilities, consisting of an extensive library of circuit primitives, increases time-to-market and yield when simulating the final matched behavior of components. The Scorpion's arbitrary impedance transformations also accurately handle non-50 Ω measurement scenarios typically associated with balanced devices, making the VNMS well suited for applications requiring ripple, insertion loss and amplitude imbalance measurements on the order of 0.1 dB.



• Amplifier Measurements

Some of today's most demanding VNA measurements involve the characterization and tuning of multiple port devices such as duplexers, combiners, couplers, etc. In a traditional 2-port VNA, the full characterization and tuning of such devices presents significant challenges in terms of measurement speed, calibration, and the switching of input signals and measurement ports. With the addition of the third measurement port, the simplicity and speed with which these devices can be tested is greatly enhanced. The MS4622B, MS4623, and MS4624B network analyzers not only offer the option of adding a third measurement port, they also offer the industry's first ever second internal source. This second source is completely independent from the main source that switches between ports 1 and 2. By the addition of this second source, the potential now exists for replacing the signal generators and spectrum analyzers currently needed to characterize the non-linear effects that occur when multiple tones are simultaneously present in the pass-band of an active device.



• Vector error-corrected noise figure measurements

The MS4622B, MS4623B, and MS4624B Vector Network Measurement Systems deliver the industry's first ever capability for making vector error-corrected noise figure measurements on active devices in today's hottest market – wireless communications. The Noise Figure options covering the frequency ranges of 50 MHz to 3 GHz and 50 MHz to 6 GHz, give you the functionality for making noise figure measurements much more accurately than has ever before been possible. This option allows for making S-parameter measurements and noise figure measurements with a single test connection. The measurement setup can be configured to make measurements with the noise source set in either an internal or an external mode. In the external mode, the noise source is connected directly to the DUT similar to traditional scalar noise figure measurements. In the internal mode, the noise source is connected to the VNA rear panel and internally routed to port 1. Therefore, when a 12-term calibration is applied concurrently with the noise figure calibration, you can make vector error-corrected noise figure measurements.

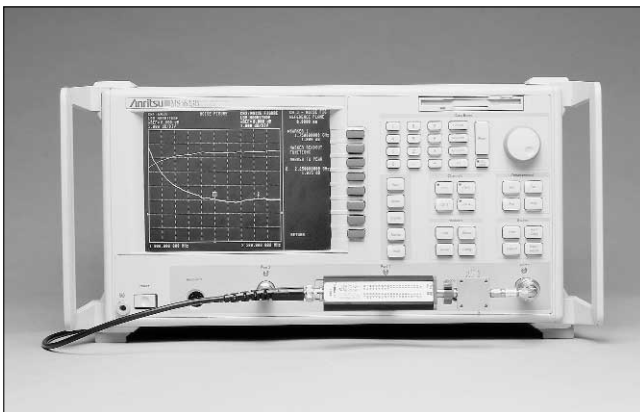

• Mixer measurements

Scorpion can also accurately characterize your mixers and other frequency-translating devices (FTDs) for isolation, match, conversion loss, noise figure and frequency translated group delay (FTGD). Without changing cables or instruments, Scorpion can make all these measurements quickly, easily and accurately. Add an external synthesizer and Scorpion can easily orchestrate swept frequency and swept power mixer IMD measurements. You no longer have to buy and integrate five separate instruments to perform these everyday measurements. With the integrated measurement flexibility of Scorpion, you can design and manufacture all of your passive, active, and frequency translating devices using a single instrument.

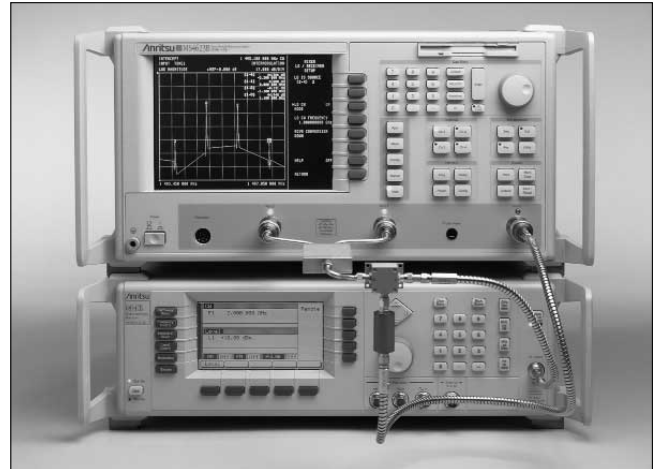

• AutoCal® Automatic Calibrators

One source of potential errors and inaccuracies in any measurement system is its calibration. A great deal of time can be wasted in a busy manufacturing environment trying to verify calibration accuracy, especially when multiple shifts run on several different test stations for the same product line. For this situation, you need a calibration system in place that offers the highest possible degree of assurance that every station on every shift is calibrated for identical results. With the Anritsu AutoCal® automatic calibrator, you get just that. Simply connect a serial cable between the AutoCal® and the rear panel of the VNA and you're ready to go. If adapters become necessary, AutoCal® can handle them with its revolutionary approach to adapter removal. This approach avoids the necessity of multiple calibrations commonly used in adapter removal calibrations. By using the AutoCal® adapter characterization process, you can calibrate in a SMA, Type N, 3.5mm, TNC, or 7/16 environment with confidence.



VECTOR NETWORK MEASUREMENT SYSTEM / DIRECT-ACCESS RECEIVER

Ethernet / GPIB

MS4622C, MS4623C, MS4624C

10 MHz to 3 GHz

10 MHz to 6 GHz

10 MHz to 9 GHz

For Measuring Antennas, Frequency Conversion, and Multiple-Output Devices

The MS462XC series of RF vector network analyzers are configured as direct-access receivers for antenna, frequency conversion, and multiple output device measurements. The MS462XC offers ultimate flexibility to meet most receiver measurement needs while maintaining the ability to measure all four S-parameters with the addition of a reflectometer setup at the front end of the receiver.

The MS462XC series offers three wide-band RF models covering the 10 MHz to 3 GHz, 6 GHz or 9 GHz ranges, MS4622C, MS4623C, and MS4624C, respectively.

Applications

• Mixers

Mixers are integral components of most measurement systems. Mixer measurements are complicated by the fact that an LO is required and multiple frequencies are involved in the complete measurement of a mixer. In addition, the mixer is non-linear so power levels must be carefully considered, and in many instances non-linear effects such as compression and intermodulation distortion must be measured. The MS462XC has many features that simplify mixer measurements. The MS462XC can include two built in sources, to

provide both the LO and RF signal required by the mixer – the system automatically tunes the receiver to the appropriate IF frequency. The unit can control additional external sources as required for inter-modulation measurements.

The setup of the sources is obviously quite important in a mixer measurement. The Mixer device type simplifies this task somewhat. It allows the quick selection of which source is to be the DUT LO. It allows simple selection of a fixed LO or fixed IF measurement scenario (and specifying that LO or IF frequency). And, it informs the receiver of what kind of DUT conversion to expect (up conversion $|\text{RF}+\text{LO}|$, down conversion $|\text{RF}-\text{LO}|$, or no conversions might be used for a quick leakage measurement). Activating the mixer device type also performs the important function of turning on both internal sources for front panel access (usually using ports 1 and 3 driving, port 2 being the receive port). Two ports are not allowed to drive simultaneously during normal S-parameter measurements.

• Antennas

Far-field measurements are enhanced with the speed of taking data over GPIB, using fast CW mode. Rates of 8,900 points per second can be achieved.

**POWER AMPLIFIER TEST SYSTEM (PATS)
ME7840A**

GPIB

800 to 2400 MHz, 100 Watts / 10 to 6000 MHz, 5 Watts

Easy-to-Use System for Power Amplifier Design and Manufacturing



PATS



HATS (Option 4)

The ME7840A Power Amplifier Test System (PATS) is a flexible, easy-to-use system for base station power amplifier testing and with the introduction of the new option 4 Handset Amplifier Test Set (HATS) it now provides full coverage to handle all of your power amplifier testing needs.

Key Benefits

- Versatility to characterize most power and handset amplifiers
- Consolidate multiple test stations and connections to increase productivity
- Improve accuracy and repeatability of S-parameter, Harmonics, Gain Compression, Intermodulation Distortion (IMD), and Adjacent Channel Power Ratio (ACPR) measurements
- Flexibility to accommodate future requirements with auxiliary paths
- Scorpion Navigator™ enables test executive integration in about a week

PATS consists of three distinct parts: The Scorpion Navigator Software, the MS462xC Vector Network Measurement System, and the MS4782D Test Set.

Measurement capabilities:

Measurements	CW	Swept Frequency (as fast as 150 μsecs/pt)	Swept Power (as fast as 150 μsecs/pt)
ACPR	√		√ ¹
S-Parameters Hot S ₂₂	√	√	√
IMD, TOI (two-tone): 3 rd , 5 th , 7 th , & 9 th	√	√	√
Gain Compression: P ₁ dB AM/PM	√ √	√	√ √
Harmonics: Magnitude Phase	√	√ √	√
Noise Figure ²	√	√	
Power Added Efficiency (PAE)	√	√	√
Drain Current	√	√	√

¹ Swept power speed is related to external source

² Noise Figure only available with option 4 (HATS test set)

Scorpion Navigator Software

The Scorpion Navigator software is installed on your computer to orchestrate the PATS and HATS measurements. The computer should be a Pentium II at 200 MHz or equivalent system with a GPIB Card (computer not included).

MS462xC Vector Network Measurement System (VNMS)

The MS462xC is the Direct Receiver Access (DRA) configuration for the MS462xx family of Vector Network Measurement Systems (VN-MS). The MS462xC series is available in two wide-band RF models covering the 10 MHz to 3 GHz or 6 GHz range (MS4622C and MS4623C respectively).

MS4782D Test Set (Option 4, MN4783A)

The MS4782D or MN4783A (option 4) Test Set provides the necessary hardware to interface between your power amplifier and the VNMS.

Scorpion Navigator Software Results

With frequency sweeps as fast as 150 μs/point and power sweeps as fast as 150 μs/point, you can quickly, thoroughly, and accurately characterize your power amplifiers in real-time.

Simultaneously overlay measurements in both frequency and power and see the results of over 250 data points updated twice per second.

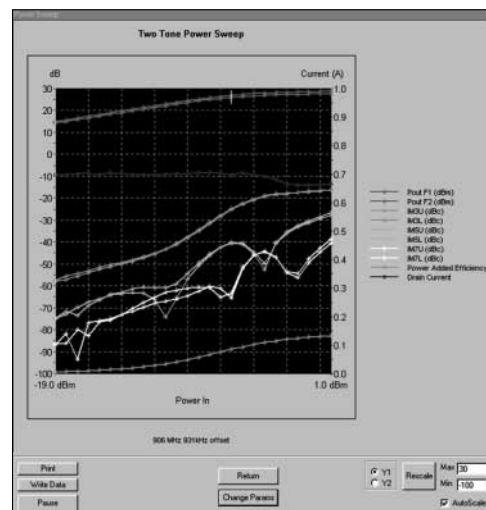

Power Amplifier Test Set Block Diagram

The following block diagram depicts the standard MS4782D Test Set design. Anritsu can configure and optimize a custom test set for your specific requirements.

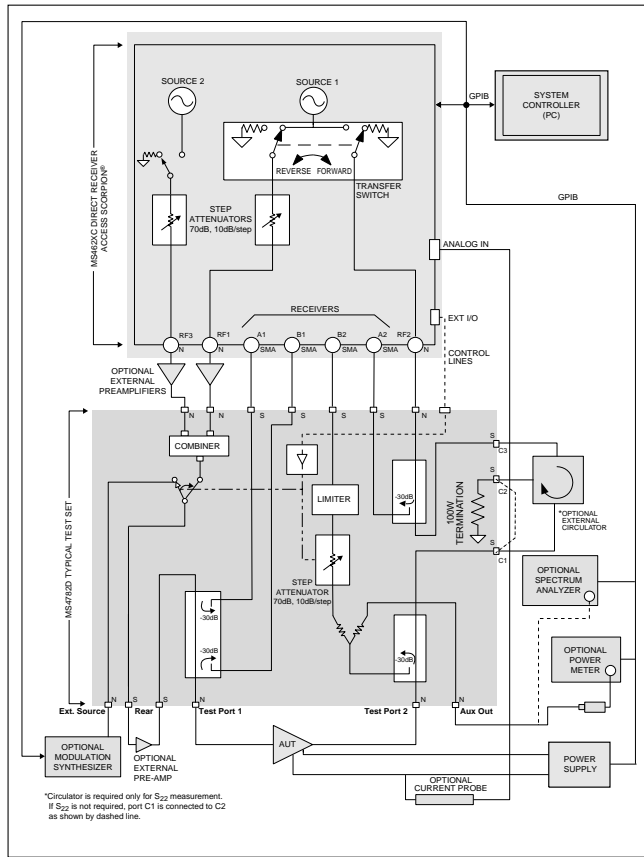

Handset Amplifier Test Set Block Diagram

The following block diagram depicts the standard MS4782D Test Set design. Anritsu can configure and optimize a custom test set for your specific requirements.

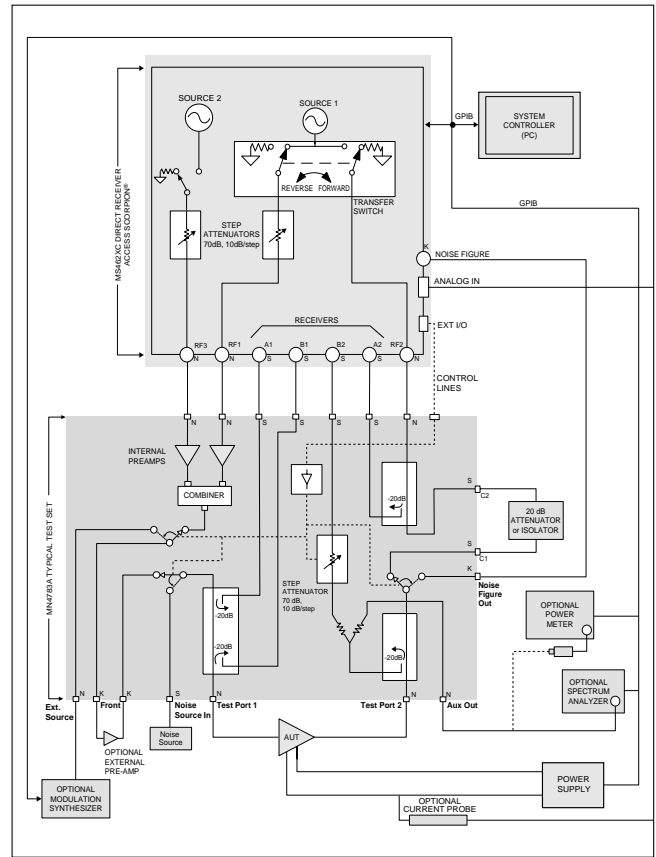

TOWER MOUNTED AMPLIFIER TEST SYSTEM (TMATS)
ME7842B

10 to 6000 MHz



Fully Characterize and Test Tower Mounted Amplifiers (TMAs) with a Single Connection



The result of working with a top infrastructure provider of Node B base station components, the ME7842B is a measurement system capable of simplifying the complexity of multi-port Tower Mounted Amplifier (TMA) test. With innovative instrumentation, flexible multi-port test set and easy-to-use software, TMATS has dramatically reduced TMA test times from hours to just minutes. The easy-to-use software, the Scorpion Navigator™, includes unprecedented features that enable integration into any manufacturing environment in about a week. The solution is now commercialized and ready to tackle your toughest TMA measurement requirements.

Key Benefits

- Versatility to characterize most TMA configurations (2 – 5 ports)
- Consolidate multiple test stations and connections to increase productivity
- Improve accuracy and repeatability of S-parameter, Harmonics, Gain Compression, Intermodulation Distortion (IMD), Noise Figure (NF), and Adjacent Channel Power Ratio (ACPR) measurements
- Flexibility to accommodate future requirements with auxiliary paths
- Scorpion Navigator enables test executive integration in about a week

TMATS consists of three distinct parts: The Scorpion Navigator software, MS462xB Vector Network Measurement System, and the MN4790A Test Set.

• Scorpion Navigator Software

The Scorpion Navigator software is installed on your computer to orchestrate the TMATS measurements. The computer should be a Pentium II at 200 MHz or equivalent system with a GPIB Card (computer not included).

• MS462xB Vector Network Measurement System (VNMS)

The MS462xB is a powerful full reversing S-parameter configuration offering performance, ease-of-use and the versatility that is required in TMA testing.

The MS462xB series is available in two wide-band RF models covering the 10 MHz to 3 GHz or 6 GHz range (MS4622B and MS4623B respectively).

• MN4790A Test Set

The MN4790A Test Set provides the necessary hardware to interface between your tower mounted amplifier (TMA) and the VNMS.

Measurement capabilities:

Measurements	CW	Swept Frequency (as fast as 150 μsecs/pt)	Swept Power (as fast as 150 μsecs/pt)
Noise Figure	✓	✓	
ACPR	✓		✓*
S-Parameters	✓	✓	✓
IMD, TOI (two-tone): 3 rd , 5 th , 7 th , & 9 th	✓	✓	✓
Gain Compression: P ₁ dB AM/PM	✓ ✓	✓	✓ ✓
Harmonics: Magnitude	✓	✓	✓
Power Added Efficiency (PAE)	✓	✓	✓

* Swept power speed is related to external source

TMATS Block Diagram

The following block diagram depicts the standard MN4790A Test Set design. Anritsu can configure and optimize a custom test set for your specific requirements.

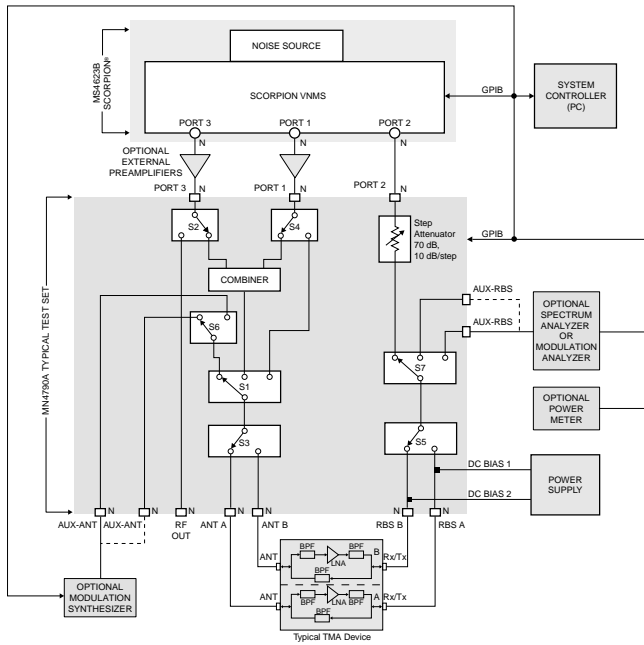

Scorpion Navigator Software Results

The Scorpion Navigator is optimized for testing both current and future TMA configurations. Once calibrated, simply choose the desired TMA path and the necessary measurement. That's all it takes to begin. Manual operation is simplified with a flexible and easy-to-use graphical user interface optimized for testing a TMA. The standard list of measurements includes: S-parameters with clear pass/fail limit lines, compression, intermodulation distortion, harmonics, noise figure and adjacent channel power ratio.

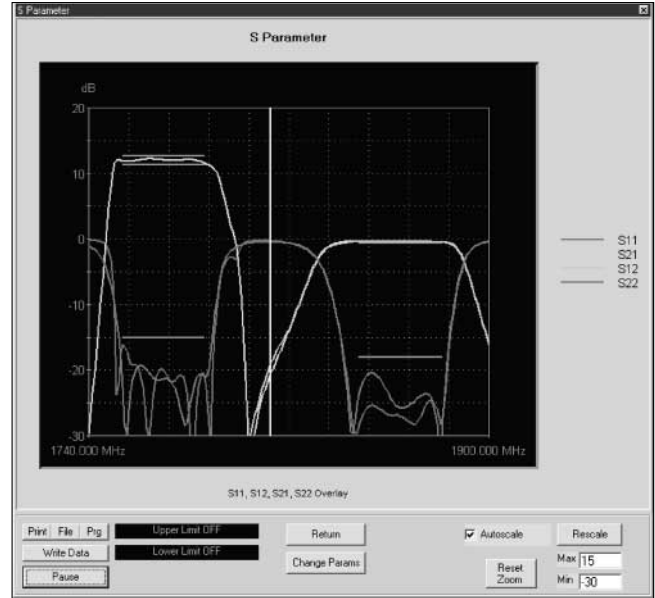

RF MULTI-PORT BALANCED VNA
MS4624D Series
 10 MHz to 9 GHz



Single Connection Differential Measurements for Signal Integrity and Multi-Port Applications

NEW

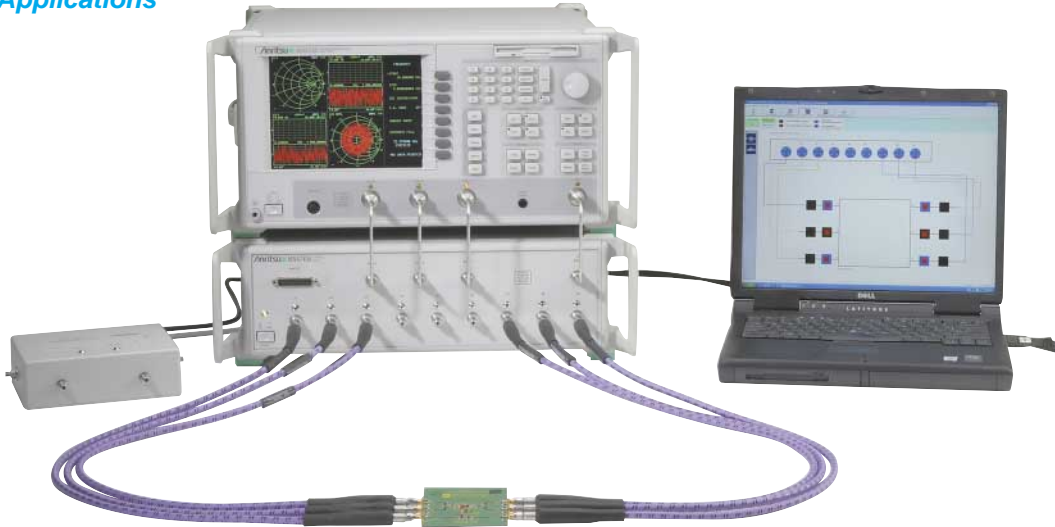

The RF Multi-Port System consists of the Scorpion® Vector Network Measurement System, the SM5992 RF Multi-Port Test Set and Navigator™ software (external personal computer is required, but not included). Simply enter your multi-port module topology and Navigator guides you quickly and intuitively through the setup so you can accurately perform multi-port measurements. Especially suited for next generation modules with balanced interfaces, Navigator also supports full N-port calibrations for the ultimate in accuracy.

Key Benefits

- Versatility to Characterize Any Module up to 9-Ports with a Single Connection
- Full N-Port Calibrations Correct for All Load Match Artifacts
- Simplifies the Complexity of Multi-Port Measurements with Easy-to-Use Software
- Transmission Accuracy of Less Than 0.1 dB
- Scalable Solutions Possible for Modules with more than 9-Ports

Versatility to Characterize Any Module up to 9-Ports

The multi-port test set employs a full interconnect fabric to ensure maximum flexibility in connecting to your modules, both present and future. In other words, this switch fabric allows any single port of the MS462xD to connect with any of the DUT ports so you can connect your module to this measurement solution with a single connection regardless of your module's paths. In addition, multi-port measurements are now nearly effortless to perform using Navigator. As an example, the following screen capture shows one setup for the main measurement screen within Navigator.

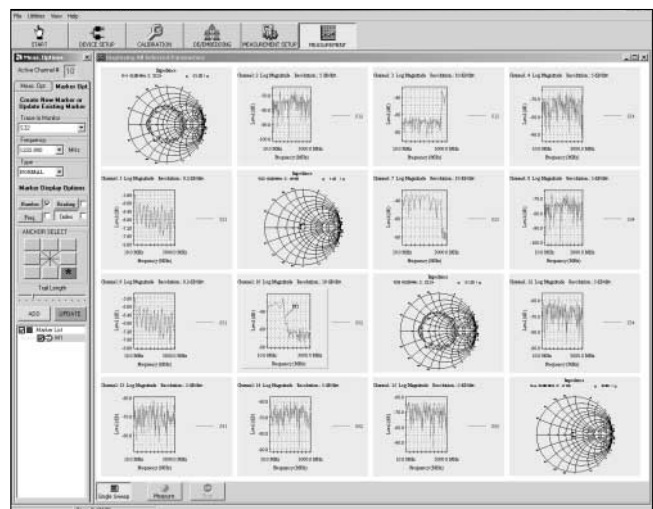
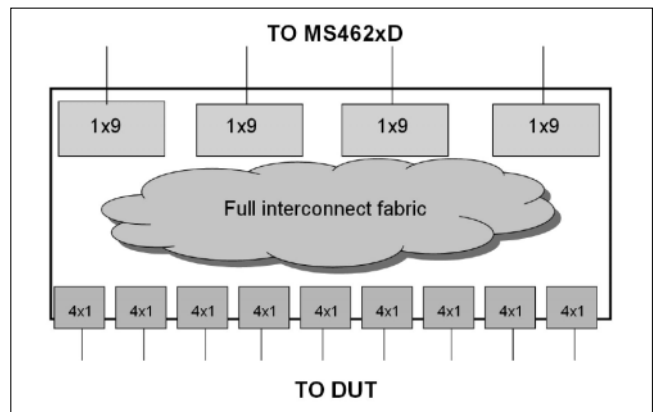

PIM-S SYSTEM (VNA AND PASSIVE INTERMODULATION TEST SYSTEM)
MS4622B Series



10 MHz to 3 GHz

Single Connection Swept Frequency PIM and S-Parameters.

NEW



The PIM-S System conducts passive intermodulation distortion (PIM) and S-parameter measurements with a single connection. This innovative system consists of the MS4622B Scorpion® Vector Network Measurement System (VNMS), SM612x PIM Power Amplifier Unit, SM612x PIM Filter Unit, and SM6130 PIM-S Software (external personal computer is required, but not included). The following table shows the optimized PIM Filter Units and PIM Power Amplifier Units that are configured together for deployment with the VNA in the desired PIM frequency range. Each PIM frequency range requires the corresponding PIM Filter Unit and PIM Power Amplifier Unit in the system configuration. Our PIM testing approach conforms to industry recommendations and IEC 62037.

PIM Frequency Range (Base Station Transmit)	PIM Filter Unit	PIM Power Amplifier Unit
2110 - 2170 MHz	SM6121	SM6122
1930 -1990 MHz	SM6123	SM6124
1805-1880 MHz	SM6125	SM6126
925-960 MHz	SM6127	SM6128

Key Benefits

- Single Connection for Swept Frequency S-parameter and PIM measurements
- Measured PIM products: Third, fifth and seventh order
- +46 dBm Maximum Output Power (each of two tones)
- -125 dBm PIM Residual Level for both reflected and transmitted (typical)
- -135 dBm PIM Residual Level for reflected PIM measurements at the switch bypass port (typical)
- S-parameters between 10 MHz and 3 GHz (standard)

PIM-S Block Diagram

The following block diagram shows the architecture of the standard PIM-S Solution.

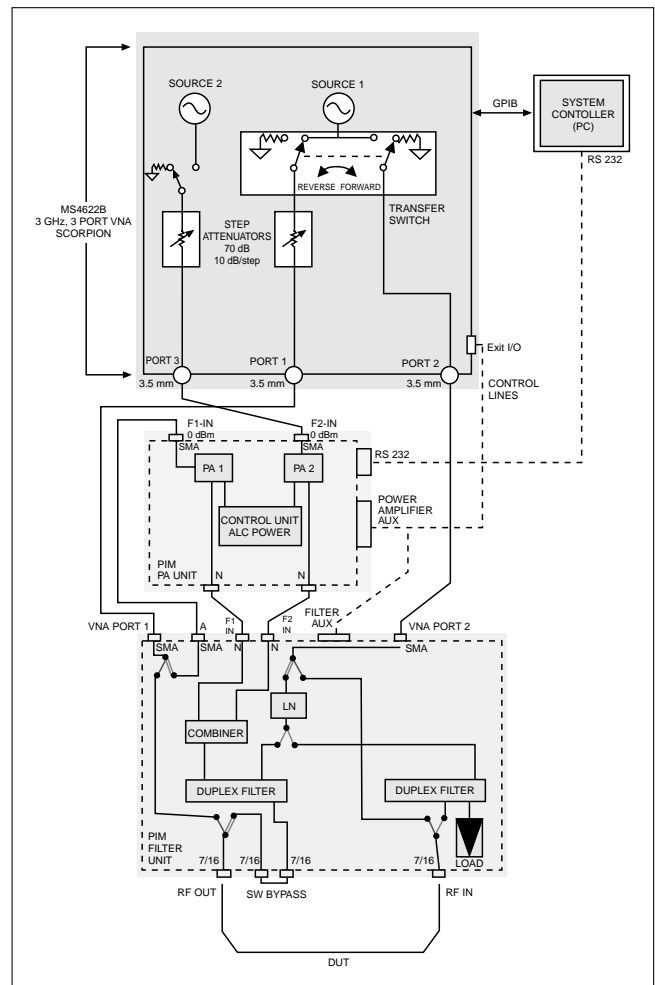

PIM-S Software Results

The PIM-S Solution can conduct both PIM and S-parameter measurements. A screen capture from the software shows the user interface and results for testing the 3rd, 5th and 7th order lower PIM

products. The software provides an intuitive way to perform setup, calibration, measurements and results in production environments. In a similar way, the S-parameter results can be viewed without changing connections.

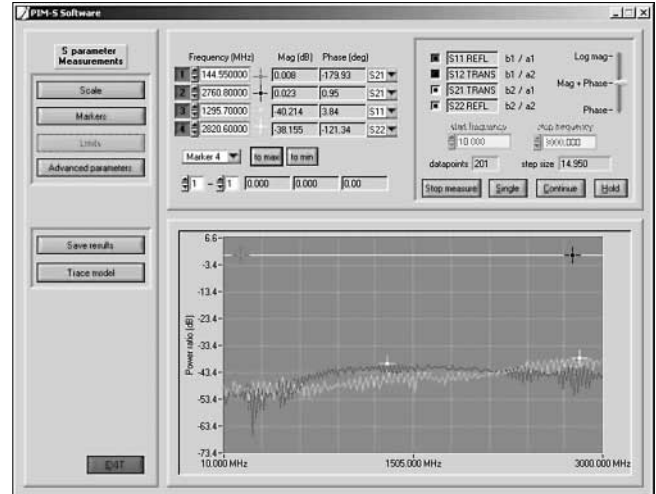
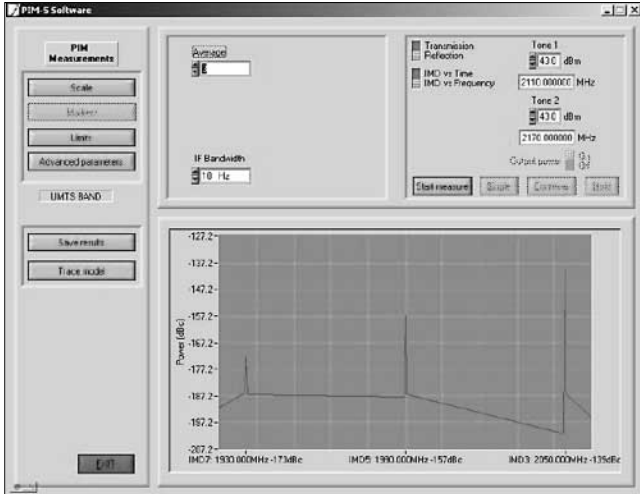

NETWORK ANALYZER
MS4630B
10 Hz to 300 MHz



For Fast Evaluation of IF Filters and Resonators



The MS4630B is suitable for electronics production lines demanding fast and accurate device measurements. It is particularly well suited to accurate, high-speed evaluation of IF filter resonance and group delay characteristics, as well as evaluating the impedance characteristics of resonators in AV equipment and personal computers. A fast sweep speed of 150 μ s/measurement point is achieved using a high-speed synthesizer and digital signal processing (DSP) technologies. The post-processing data analysis functions have been strengthened with improved data-processing macros that have greatly increased the total production throughput. In comparison to the earlier MS3401A/B and MS3606B network analyzers, the sweep speed is three times faster and the group delay measurement accuracy and stability have been improved by more than 10 times. In addition, the dynamic range has been improved to 120 dB (RBW: 1 kHz) while the weight of the analyzer has been dramatically reduced. The GPIB and PTA processing speed are 30 to 50% faster than the MS4630A. In addition, the sweep conditions can be set more easily by the addition of the list sweep function.

Features

- High-speed evaluation of IF filters, resonators, etc.
- Greatly increased production/inspection capacity

Performance and functions

• High dynamic range

The high dynamic range of 120 dB (RBW: 1 kHz) permits fast and accurate out-of-band measurement of filter.

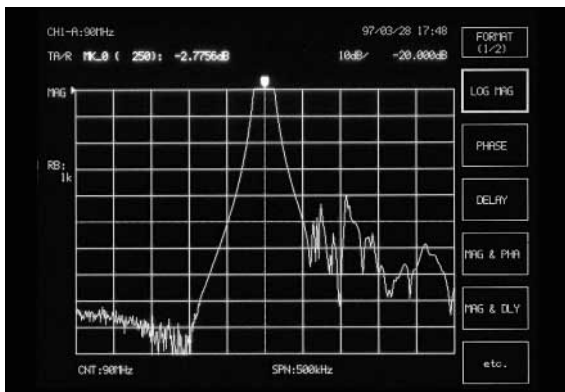

Filter out-of-band attenuation measurement

• Multi-marker function

Up to 10 markers can be set independently for each channel. The marker list function can be used to display all tabular data and waveform information simultaneously at each marker.

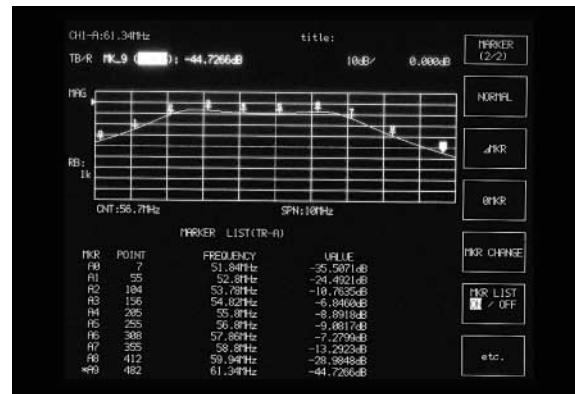

Multi-markers

• High-accuracy group delay measurement

The group delay characteristics can be measured with a high degree of accuracy at a resolution of 1/10,000 of the measurement range.

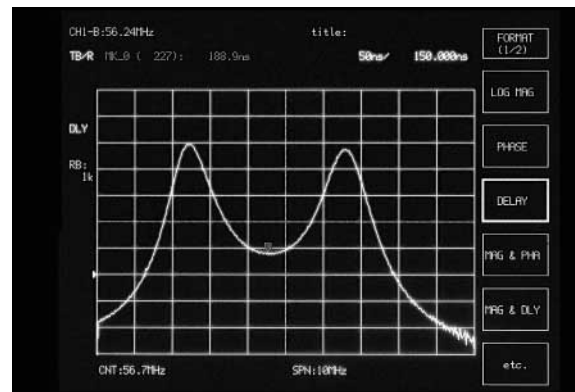

Group delay characteristics

• Limit test function

Device pass/fail evaluation can be performed in real-time using the single and segmented limit test functions.

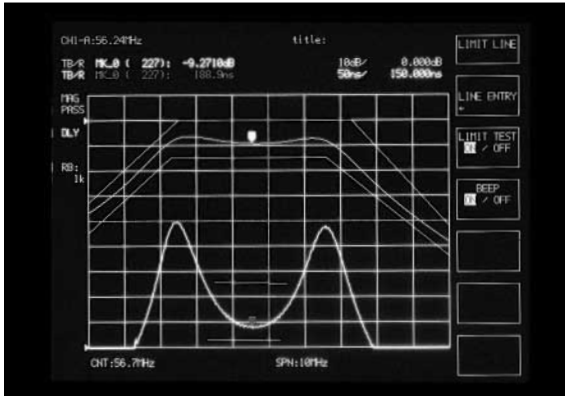

Filter pass/fail evaluation using limit test

• Filter measurement

Filter analysis functions

Filter characteristics such as 3 dB bandwidth, center frequency (fo), in-band ripple, out-of-band attenuation, etc., are digitally processed and analyzed at high speed. User can easily enter or change default values using filter set up menu.

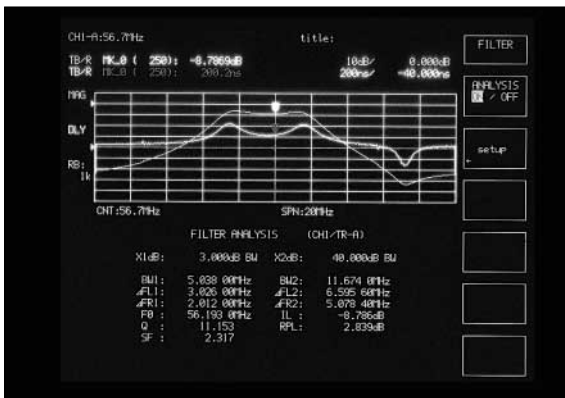

Measurement using filter functions

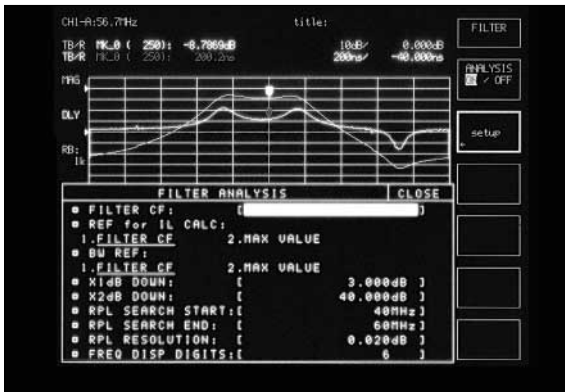

Set up menu for filter functions

Simultaneous in-band and spurious response data display

Previously, spurious detection and passband measurement required switching of the measurement setup. The MS4630B alternate sweeping function permits simultaneous display of the measured passband and spurious band data. The very short switching time greatly improves the measurement efficiency.

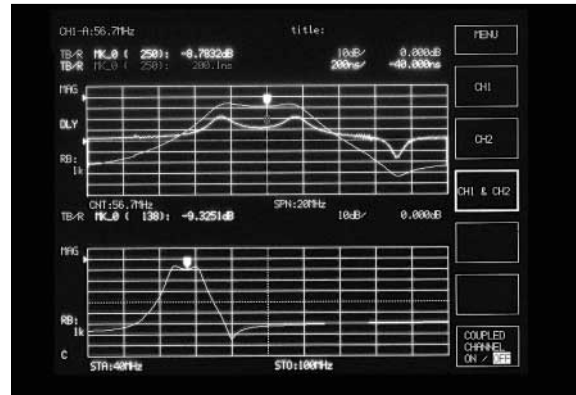

Spurious measurement using alternate sweeping

• Resonator measurement

High-speed measurement of resonator characteristics

The MS4630B has a number of dedicated waveform analysis functions to improve the evaluation efficiency of resonators. Resonator 1 analyzes the resonance frequency (Fr) and the resonance impedance (Zr). Resonator 2 is able to measure resonator equivalence in addition to the parameters for Resonator 1.

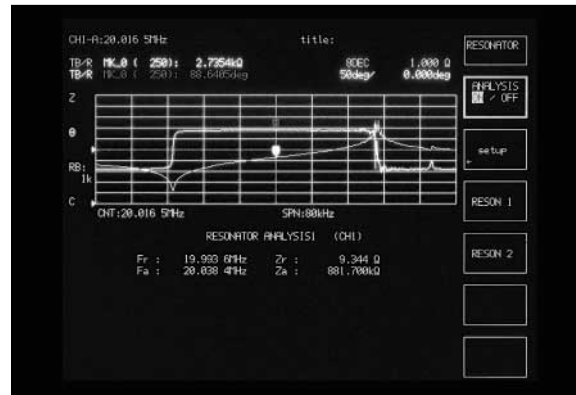

Resonator 1 measurement

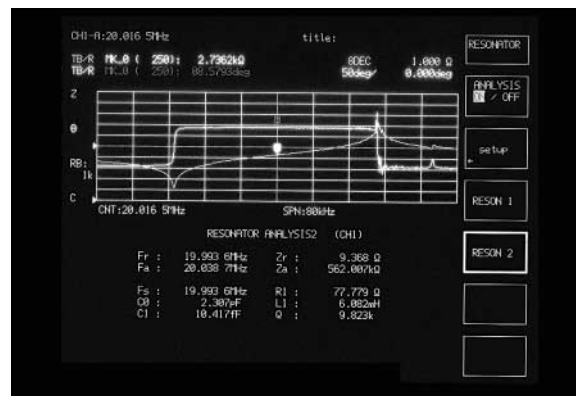

Resonator 2 measurement

4 PORT VECTOR NETWORK ANALYZER AUTOMATIC CALIBRATOR

36584 Series

10 MHz to 9 GHz



Automatic, High-Reliability, and High-Quality Calibrators for Multi-port Coaxial Device Measurements



The 36584 series AutoCal® modules are automatic calibrators that provide fast, repeatable, and high-quality coaxial calibrations for 2, 3, and 4-Port S-parameter requirements up to 9 GHz. These modules contain precisely characterized calibration standards that aid in the removal of normal systematic errors when using the MS46XXA/B/C/D series Vector Network Measurement System (VNMS). The 4-Port AutoCal is available in two models: 10 MHz to 9 GHz, with N (f) connectors and 10 MHz to 9 GHz, with K (f) connectors. 4-Port AutoCal modules come with a data file characterizing each standard in the calibrator module. Each module is guaranteed to perform to its specifications for six months without re-characterization. Following this period, re-characterization can be performed by the customer, or by sending the module to the nearest service center. The 4-Port AutoCal has a direct serial interface to the MS462x series of Anritsu Vector Network Measurement Systems. The control software is built-in to the VNMS.

Features

- **Calibration types**

1-port S_{11} and S_{22} calibration, and full 2-port, 12-term OSLT, 3-port, 24-term OSLT, and 4-port, 40-term OSLT calibrations can be performed with the 4-Port 36584 series AutoCal.

- **Fast**

Significantly reduces calibration time making it ideal for the manufacturing environment.

- **Reliable**

Eliminates unreliable measurements due to inaccurate manual calibrations.

- **Accurate**

Accuracy that exceeds OSLT calibration, with broadband loads. Characterized modules are traceable to NIST.

- **True thru**

Inherently, the internal calibrator thru is not as accurate as an external direct thru connection. The true thru mode offers the choice of manually removing the AutoCal module for a true thru calibration.

- **Isolation cal**

Isolation cal is offered as part of a full 2, 3, or 4-port calibration. The user is given the option of skipping isolation, using the default averaging factor during isolation, or entering a custom averaging factor.

- **Thru update**

Due to cable movements and aging, periodically updating the thru portion of a calibration is recommended. Thru update mode offers the choice of simply performing a direct manual thru step to update a current calibration. This is easily performed without having to invoke the AutoCal module.

- **Manual control**

Manual control offers the ability to connect any of the internal standards to the test ports of the VNA. This feature could be used to manually verify a calibration.

- **Adapter removal**

VNA calibration for testing non-insertable devices requires phase equal insertables. If this is not possible, or is undesirable, adapter removal calibration is the solution. Adapter removal requires two full 12-term calibrations, moving an adapter from one test port cable to the other between calibrations (a job AutoCal makes quick and easy). Internal software mathematically subtracts the effect of the adapter, yielding the desired adapter-less measurement.

VECTOR NETWORK ANALYZER AUTOMATIC CALIBRATOR

3658 Series

10 MHz to 40 GHz

Automatic, High-Reliability, and High-Quality Calibrators for Coaxial Device Measurements

The 3658 series AutoCal[®] modules are automatic calibrators that provide fast, repeatable, and high-quality coaxial calibrations up to 40 GHz. These modules contain precisely characterized calibration standards that aid in the removal of normal systematic errors when using vector network analyzers (VNAs). AutoCal is available in four models: 0.04 to 18 GHz, with N (m) to N (f) connectors, 0.01 to 9 GHz and 0.04 to 20 GHz, with K (m) to K (f) connectors, and 0.04 to 40 GHz, with K (m) to K (f) connectors.

AutoCal modules come with a data file characterizing each standard in the calibrator module. Each module is guaranteed to perform to its specifications for six months without re-characterization. Following this period, re-characterization can be performed by the customer, or by sending the module to the nearest service center.

Test port cable converter sets aid the user in calibrating a VNA for testing non-insertable devices and devices with SMA or 3.5 mm connectors. Test port converter sets are available for K Connector, SMA, and 3.5 mm connectors. Adapter removal calibration is required for N type non-insertable device testing.

AutoCal has a direct serial interface to the 37xxx and MS462x series of Anritsu vector network analyzers. The control software is built-in to the VNA. For operation with the 360B and/or older generation 37xxx models, an external PC running Microsoft Windows[®] with a National Instruments IEEE488.2 GPIB interface card is required.

Features

- **Calibration types**

1-port S_{11} and S_{22} calibration, and full 2-port, 12-term OSLT calibrations can be performed with AutoCal.

- **True thru**

Inherently, the internal calibrator thru is not as accurate as an external direct thru connection. The true thru mode offers the choice of manually removing the AutoCal module for a true thru calibration.

- **Isolation cal**

Isolation cal is offered as part of a full 2-port calibration. The user is given the option of skipping isolation, using the default averaging factor during isolation, or entering a custom averaging factor.

- **Switch averaging**

The mechanical module uses an electromechanical switch to select the calibration standards. Switch averaging is offered to reduce the effects of the electromechanical switch's non-repeatability. A 6 dB reduction of non-repeatability can be achieved by increasing switch averaging by a factor of four, at the expense of the overall calibration time.

- **Thru update**

Due to cable movements and aging, periodically updating the thru portion of a full 12-term calibration is recommended. Thru update mode offers the choice of simply performing a direct manual thru step to update a current calibration. This is easily performed without having to invoke the AutoCal module.

- **Manual control**

Manual control offers the ability to connect any of the internal standards to the test ports of the VNA. This feature could be used to manually verify a calibration.

- **Adapter removal**

VNA calibration for testing non-insertable devices, requires phase equal insertables. If this is not possible or is undesirable, adapter removal calibration is the solution. Adapter removal requires two full 12-term calibrations, moving an adapter from one test port cable to the other between calibrations (a job AutoCal makes quick and easy). Internal software mathematically subtracts the effect of the adapter, yielding the desired adapter-less measurement.

O/E CALIBRATION MODULE

MN4765A

40 MHz to 65 GHz



For Highly Accurate and Stable Optoelectronic Measurements



The MN4765A is a characterized, unamplified photodiode module. It is used as an optical receiver with the 37000D series VNAs to perform highly accurate and stable optoelectronic measurements of both modulators (E/O) and photoreceivers (O/E) to 65 GHz. The MN4765A consists of an InGaAs photodiode that converts modulated optical signals to electrical signals, and includes additional circuitry for temperature and bias stability. The photodiode has exceptional bandwidth response to 65 GHz and a typical responsivity of 0.7A/W. The MN4765A is characterized for 1550 nm in both magnitude and phase using a NIST derived calibration standard.

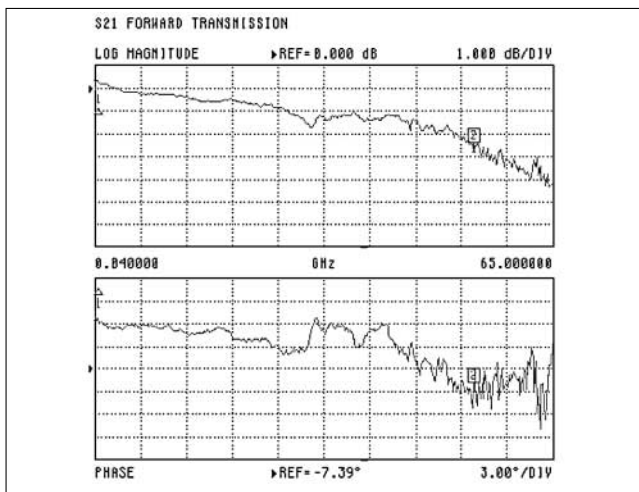

Frequency response of the MN4765A

Features

- **Fast and accurate optoelectronic measurements**

The 37000D series VNAs, when calibrated using the MN4765A module, enable error-corrected Transfer Function, Group Delay and Return Loss measurements of E/O and O/E components and subsystems.

- **NIST derived characterization to 65 GHz**

Magnitude and phase characterization is obtained using a primary standard characterized by NIST and held in the Anritsu Calibration Lab. The magnitude and phase data is provided on a diskette with the module.

- **Temperature Stable**

The MN4765A is thermally stabilized to eliminate drift in photodiode performance over temperature.

- **Internal Biasing**

Accurate bias voltage to the photodiode is maintained internally. An external, multi-country, AC adapter is included for easy operation.

- **High Linearity**

Linear operating range to +6 dBm for transfer function measurement uncertainties of < 0.5 dB at 50 GHz and < 1 dB at 65 GHz.*

- **High Responsivity**

0.7 A/W (typical)

VNA AND VNMS Calibration Kits

For Performing Precise Calibrations of Vector Network Analyzers



3753R



3656

The Anritsu Calibration Kits contain all the precision components and tools required to calibrate your VNA or VNMS for error-corrected measurements in the connector style of your choice. Components are included for calibrating male and female test ports as required. The kits support calibration with opens, shorts, and broadband loads. Option 1 adds sliding terminations and a pin depth gauge where required.

Each calibration kit is individually serialized and characterized to ensure precise calibrations. A calibration coefficients diskette is included in the kit that is directly readable into the instrument.

The following kits are for use with 37XXX Lightning VNAs.

3650 SMA/3.5 mm Calibration Kit consisting of:

- 34ASF50-2 Female Adapter (2)
- 33FSF50 Female-Female Adapter (2)*
- 33SS50 Male-Male Adapter*
- 28S50-2 B Male Termination (2)
- 28SF50-2 Broadband Female Termination (2)
- 33SSF50-Male-Female Adapter (2)*
- 24S50 Male Open
- 23SF50 Female Open
- 23S50 Male Short
- 23SF50 Female Short
- 34AS50-2 Male Adapter (2)
- Connector Thumb Wheel (4)
- 01-201 Torque Wrench
- 01-210 Reference Flat
- 01-222 Pin Depth Gauge
- 01-223 Pin Depth Gauge
- Calibration coefficients diskette

Option 1

Adds the following:

- 01-212 Female Flush Short
- 01-211 Male Flush Short
- 17SF50 Female Sliding Termination
- 17S50 Male Sliding Termination

3651 GPC-7 Calibration Kit consisting of:

- 28A50-2 Broadband Termination (2)
- 24A50 Open
- 23A50 Short
- 01-200 Torque Wrench
- 01-221 Collet Extractor Tool and 4 Collets
- Calibration coefficients diskette

Option 1

Adds the following:

- 17A50 Sliding Termination
- 01-210 Reference Flat
- 01-220 Pin Depth Gauge

3652 K Connector® Calibration Kit consisting of:

- 34AKF50-2 Female Adapter (2)
- 33FKF50 Female-Female Adapter (2)*
- 33KK50 Male-Male Adapter*
- 28K50-2 Male Termination (2)
- 28KF50-2 broadband Female termination (2)
- 33KKF50-Male-Female Adapter (2)*
- 24K50 Male Open
- 23KF50 Female Open
- 23K50 Male Short
- 23KF50 Female Short
- 34AK50-2 Male Adapter (2)
- 01-201 Torque Wrench
- 01-210 Reference Flat
- 01-222 Pin Depth Gauge
- 01-223 Pin Depth Gauge
- Calibration coefficients diskette
- Connector thumb wheel (4)

Option 1

Adds the following:

- 17KF50 Female Sliding Termination
- 17K50 Male Sliding Termination
- 01-212 Female Flush Short
- 01-211 Male Flush Short

* Phase Equal Adapters

3653 Type N Calibration Kit consisting of:

- 23NF50 Female Short
- 23N50 Male Short
- 24NF50 Female Open
- 24N50 Male Open
- 28N50-2 Broadband Male Termination (2)
- 28NF50-2B Broadband Female Termination (2)
- 34AN50-2 Male Adapter (2)
- 34ANF50-2 Female Adapter (2)
- 01-213 Reference Gauge
- 01-224 Pin Depth Gauge
- Calibration coefficients diskette

3654B V Connector® Calibration Kit consisting of:

- 23V50B-5.1 Male Short 5.1mm
- 23VF50B-5.1 Female Short 5.1mm
- 24V50B Male Open
- 24VF50B Female Open
- 28V50B Male Broadband Termination (2)
- 28VF50B Female Broadband Termination (2)
- 17VF50B Female Sliding Termination
- 17V50B Male Sliding Termination
- 33VV50 Male-Male Adapter*
- 33VVF50 Female-Female Adapter (2)¹
- 33VVF50 Male-Female Adapter (2)¹
- Calibration coefficients diskette
- Connector thumb wheel (4)
- 01-201 Torque Wrench
- 01-210 Reference Flat
- 01-322 Pin Depth Gauge
- 01-323 Female Adapter for pin gauge
- 01-204 Adapter Wrench
- 01-312 Male Flush Short
- 01-311 Female Flush Short

3655 Waveguide Calibration Kit

The 3655 Calibration Kit contains all of the precision components and tools required to calibrate your VNA for 12-term error-corrected measurements of test devices with the appropriate waveguide designation. Components are included for calibrating both module ports. The kit supports calibration with offset shorts and broadband loads. Option 1 adds a sliding termination.

Consisting of:

- Short, Flush (2)
- Offsets, 1/8 and 3/8 Wavelength
- Terminations, Fixed (2)
- Test Port Sections (2)

Option 1**Adds the following:**

- Sliding Termination

3656 W1 (1.0 mm) Connector Calibration Kit and Verification Kit

The W1 calibration kit consists of precision components to calibrate the VNA to 110 GHz. The kit supports SOLT calibrations with opens, shorts and loads to 65 GHz, and Triple Offset short calibrations from 65 to 110 GHz. The kit also includes verification devices for determining system accuracy of the VNA. A diskette containing factory measured test data is supplied for comparison with customer measured data.

Consisting of:

- 23W50-1, Male Offset Short 2.02 mm
- 23WF50-1, Female Offset Short 2.02 mm
- 23W50-2, Male Offset Short 2.65 mm
- 23WF50-2, Female Offset Short 2.65 mm
- 23W50-3, Male Offset Short 3.180 mm
- 23WF50-3, Female Offset Short 3.180 mm
- 24W50, Male Open 1.510 mm
- 24WF50, Female Open 1.930 mm
- 28W50, Male Broadband Termination
- 28WF50, Female Broadband Termination
- 33WW50, Male-Male Adapter (1)
- 33WWF50, Male-Female Adapter (1)
- 33WFWF50, Female-Female Adapter (1)

- 01-401, Interchangeable Adapter Fixed Female²
- 01-402, Interchangeable Adapter Fixed Male²
- 18WWF50-1, 50 Ω Matched ThruLine (Verification Device)
- 18WWF50-1B, Stepped Impedance ThruLine (Verification Device)
- 01-504, Torque Wrench
- 01-505, End Wrench
- Calibration coefficients diskette
- Verification kit diskette

The following kits are for use with MS462XX Scorpion® VNMS.**3750R SMA/3.5 mm 9 GHz Calibration Kit consisting of:**

- 23LF50 Female Short
- 23L50 Male Short
- 24LF50 Female Open
- 24L50 Male Open
- 28L50LF Male Termination (2)
- 28LF50LF Female Termination (2)
- Calibration coefficients diskette

Option 1**Adds the following:**

- Set of five Phase Equal Insertables (PEIs)

Option 3**Adds the following:**

- Additional 3.5 mm (female) and 3.5 mm (male) terminations required for four port calibrations

3751R GPC-7 9 GHz Calibration Kit consisting of:

- 23A50 Short
- 24A50 Open
- 28A50LF Termination (2)
- Calibration coefficients diskette

Option 2**Adds the following:**

- Third GPC-7 termination required for three port calibrations

Option 3**Adds the following:**

- Two additional GPC-7 terminations required for four port calibrations

3753R Type N 9 GHz Calibration Kit consisting of:

- 23NF50 Female Short
- 24NF50 Female Open
- 24N50 Male Open
- 28NF50LF Female Termination (2)
- 28N50LF Male Termination (2)
- 23N50 Male Short
- Calibration coefficients diskette

Option 1**Adds the following:**

- Set of five Phase Equal Insertables (PEIs)

Option 3**Adds the following:**

- Additional N (female) and N (male) terminations required for four port calibrations

3753-75R Type N (75 Ω) Calibration Kit:

- Specified to 3 GHz

Option 3**Adds the following:**

- Additional N (75 Ω female) and N (75 Ω male) terminations required for four port calibrations

¹ Phase Equal Adapters

² Interchangeable adapters have one fixed end and one interchangeable end. The interchangeable end can be switched between a male and female. This preserves the calibration reference plane for non-insertable device measurements.

VNA AND VNMS Verification Kits

*For Confirming Accuracy of Vector
Network Analyzers*



3669B

The Anritsu Verification Kits contain precision components with characteristics that are traceable to NIST. Used primarily by the metrology laboratory, these components provide the most dependable means of determining the system accuracy of your VNA. A disk containing factory measured test data for all components is supplied for comparison with customer-measured data.

The following kits are for use with 37XXX Lightning VNAs.

3663 Type N Verification Kit consisting of:

- 42N-50, 50 dB Attenuator
- 18N50-10, 10 cm Airline
- 42N20, 20 dB Attenuator
- 18N50-10B, 10 cm Stepped Impedance Airline (Beatty standard)
- Verification kit disks

3665 Waveguide Verification Kit consisting of:

- Straight section
- Pin set
- Mismatch section
- Ball driver
- 50 dB Attenuator
- 20 dB Attenuator
- Verification kit disks

3666 SMA/3.5 mm Verification Kit consisting of:

- 19S50-7, 7.5 cm Airline
- 19SF50-7B, 7.5 cm Stepped Impedance Airline (Beatty standard)
- 42S-50, 50 dB Attenuator
- 42S-20, 20 dB Attenuator
- Verification kit disks

3667 GPC-7 Verification Kit consisting of:

- 42A-50, 50 dB Attenuator
- 18A50-10, 10 cm Air line
- 42A-20, 20 dB Attenuator
- 18A50-10B, 10 cm Stepped Impedance Airline (Beatty standard)
- Verification kit disks

3668 K Connector® Verification Kit consisting of:

- 19K50-7, 7.5 cm Airline
- 42K-50, 50 dB Attenuator
- 42K-20, 20 dB Attenuator
- 18K50-7B, 7.5 cm Stepped Impedance Airline (Beatty standard)
- Verification kit disks

3669B V Connector® Verification Kit consisting of:

- 42V-40, 40 dB Attenuator
- 42V-20, 20 dB Attenuator
- 19V50-5, 5 cm Airline
- 18V50-5B, 5 cm Stepped Impedance Airline (Beatty standard)
- Verification kit disks

W1 (1.0 mm) Verification Components are included in W1 Calibration kit and Verification Kit (3656). See previous section for details.

The following kits are for use with MS462XX Scorpion VNMS.

3663R Type N 9 GHz Verification Kit consisting of:

- 42N-50, 50 dB Attenuator
- 42N20, 20 dB Attenuator
- 42NOP-20 N Mismatch attenuator
- Verification kit disks

3666R SMA/3.5 mm 9 GHz Verification Kit consisting of:

- 42L-50, 50 dB Attenuator
- 42L-20, 20 dB Attenuator
- 42LOP-20 SMA/3.5 mm Mismatch Attenuator
- Verification kit disks

3667R GPC-7 9 GHz Verification Kit consisting of:

- 42A-50, 50 dB Attenuator
- 42A-20, 20 dB Attenuator
- 42AOP-20 GPC-7 Mismatch Attenuator
- Verification kit disks

MICROWAVE FREQUENCY COUNTER

MF2400B Series

10 Hz to 20/27/40 GHz



For Measuring CW Frequency and Pulse Width of Burst Signals



The MF2400B series consists of three frequency counters: the MF2412B (20 GHz), the MF2413B (27 GHz), and the MF2414B (40 GHz). They are ideal for evaluating mobile radio communications devices and circuits, with the ability to measure the carrier frequency and pulse width of burst signals. In addition to displaying measurement results on a 12-digit LCD, the frequency values can be read using the analog display function, which is ideal for monitoring evaluation and especially for frequency adjustment, etc., as in the case of various types of oscillators.

Furthermore, the template function is useful for assessing quickly whether or not the measurement results fall within the upper and lower frequency limit specifications; the evaluation result is output from the AUX connector on the rear panel as a Go/No-go signal. An easy-to-use automatic measurement system can be configured using the GPIB function.

Features

- Measures carrier frequency and pulse width of burst signals
- Analog frequency display
- Pass/Fail evaluation for frequency range specified by template function
- Measurement of any burst section using gating function

Functions

• Wide band measurement

The three counters, with upper frequency limits of 20, 27 and 40 GHz, meet every usage requirement. In addition, a high-frequency fuse holder and fuse element protects the input circuit from excessively powerful signals, and a variety of adapters are available for coupling each connector.

• High-accuracy burst measurement

The carrier frequency, burst width, and burst repetition rate of a 100 ns to 0.1 s burst signal input from INPUT 1 can be measured quickly with high accuracy.

• Save and recall functions added

Up to a maximum of 10 setups can be stored in the internal memory, and these can be freely recalled. Storing complex setups in advance, such as burst triggers and gate settings, makes it possible to recall them immediately when needed for measurement, which makes it possible to reduce the measurement setup time and to prevent malfunctions from setup mistakes.

• Analog display function

Using this function, the entire LCD becomes an analog meter and the measured values are indicated by the position of the meter needle. In addition to measuring changes in the frequency, this permits faster frequency adjustment and Go/No-go judgement of oscillators, which had to be read many digits of measured data before. This analog meter also solves problems associated with misreading frequency values.



Moves left/right and indicates frequency value

• Template function

After the upper and lower frequency limits have been preset, if the measured frequency is within the preset range, Go is displayed; if it is out of range, No-go is displayed. In addition, the Go/No-go signal can be output from the AUX connector on the back panel as a TTL signal. This is very useful for configuring an automatic device Pass/Fail evaluation system (using analog display).

• High-speed transient measurement

Frequency counters have an interval when measurement is not performed (sample rate), so that sudden frequency changes during this period cannot be measured. However, the MF2400B series overcomes this problem by capturing frequency changes at speeds of up to 10 μ s and saving a maximum of 2000 sampling points. When it is combined with a host computer, frequency changes can be displayed graphically. This is very effective for measuring VCO start-up characteristics and PLL lock times.

• Gating function

With burst signal measurements, the carrier frequency may be different at the start, middle, and end of the burst. In the MF2400B series, the carrier signal frequency at any position of the signal (delay time from trigger signal leading edge) and at any specified time (gate time) can be measured using a combination of the gating and trigger delay functions.

CALIBRATION RECEIVER
ML2530A
 100 kHz to 3 GHz



Measuring Level while Observing Signals under Test



The ML2530A is a receiver for calibrating the output power level of such devices as signal generators and attenuators, covering the range of 100 kHz to 3 GHz. It is suitable for use as a reference level meter for the RF communications bands used by the world's mobile communications markets. High linearity is achieved by using a level detector that uses DSP technology. The level can be measured while observing the signal waveform to be measured by using the spectrum monitor function.

Features

- Wide dynamic range of -140 to +20 dBm and high linearity
- Provides measurement bandwidth of 1 Hz to 100 kHz, so that even signals with large residual FM can be measured using the 1 Hz bandwidth.
- Supports level units

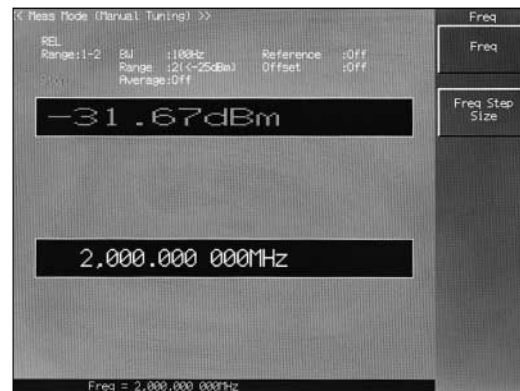

Manual tuning mode

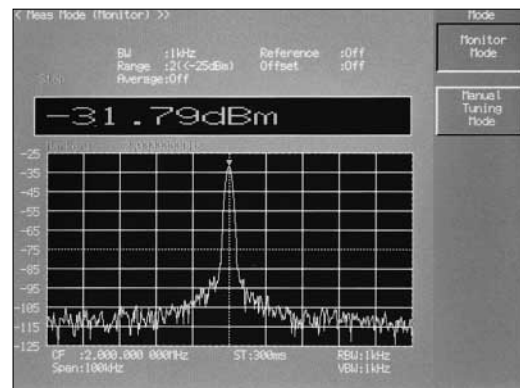

Monitor mode

SCALAR NETWORK ANALYZER
54100A Series
 1 MHz to 110 GHz

GPIB

Fast and Accurate Scalar Network Measurements, with Built-in Source

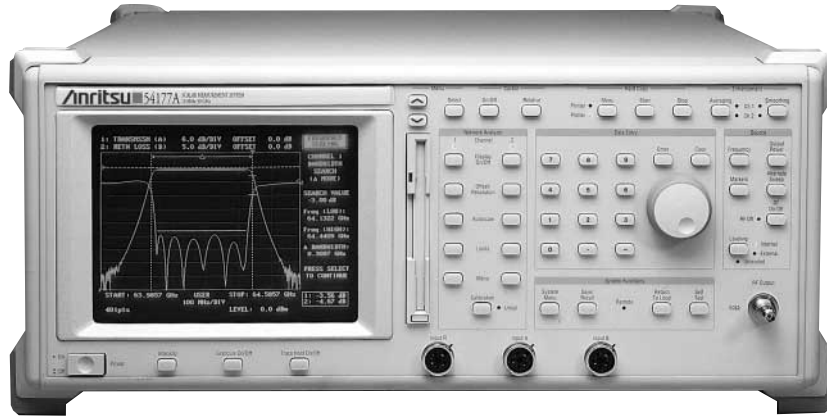

54100A series Scalar Network Analyzers provide characterization of devices such as amplifiers, antennas, attenuators, adapters, RF bridges, duplexers, couplers, attenuators, cables, waveguide transmission lines, isolators, circulators, mixers, receivers, transceivers, up/down converters, multiplexers, power dividers, VCOs, switches, and filters. Advanced hardware and software features speed productivity and improve accuracy. Speed tuning processes with automated bandwidth search functions. Fast recall mode quickly steps through test procedures and sophisticated limit line controls quickly identify conformance to specifications. Low source harmonics and high directivity SWR autotesters assure accuracy.

Features

- Fast, accurate measurement of transmission, return loss, precision return loss, SWR, group delay, absolute power, and distance-to-fault
- Crystal-based source for exceptional stability and accuracy
- Built-in automation features including distance-to-fault
- Built-in floppy disk drive
- Rugged, reliable chassis
- **Transmission gain (loss), group delay and power measurements**
 The basic configuration requires a single detector. For very low transmission loss devices (<0.25 dB), a second detector should be used to monitor any source power variations.

• Transmission and return loss (or SWR)

Return loss or standing wave ratio (SWR) measurements require a high directivity SWR autotester to separate the incident signal from the RF sweep source and reflected signal from the device under test. The configuration below will simultaneously display transmission and return loss characteristics.

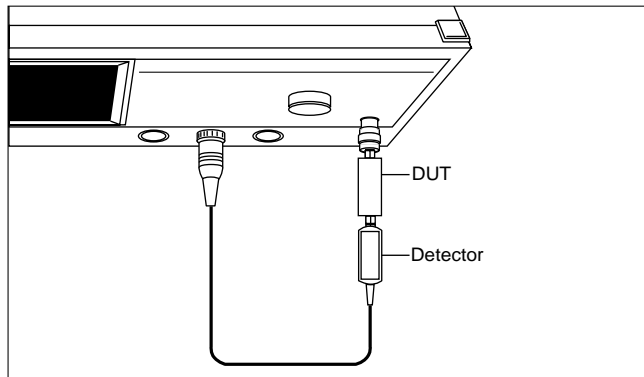
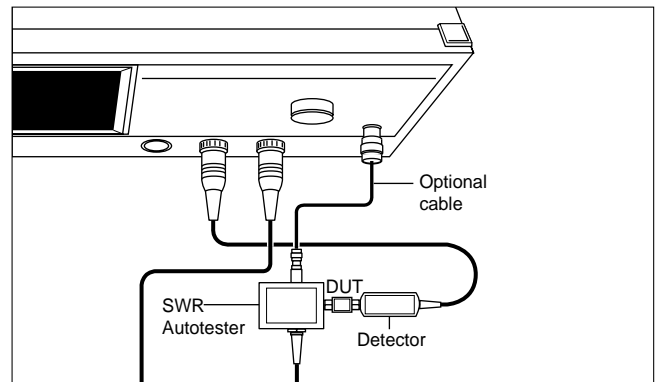

• Adapters, attenuators, terminations, couplers, RF bridges

The 54100A series precision return loss mode measures high return loss devices accurately traceable to NIST. The measurement system uses an offset SWR autotester and a precision airline — a physical impedance standard. Additionally, by exchanging the offset SWR autotester with a 20 dB offset termination, the directivity of couplers and RF bridges is displayed directly on the 54100A.

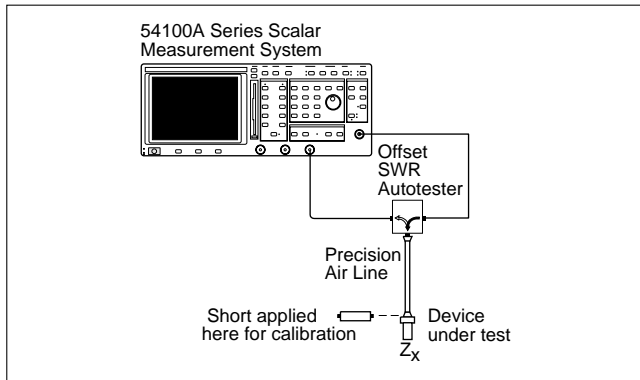

Distance-to-fault

The 54100A's optional distance-to-fault software accurately verifies transmission line and antenna system performance during installation, link/site commissioning, and at regular maintenance intervals. Transmission lines are typically the most common failure point in an antenna system. Finding the problem connectors, cables, and antennas before a complete failure occurs saves down-time and expense. Faulty antenna systems and transmission lines are easily diagnosed. A wide variety of coaxial and waveguide types are supported with standard catalog components.

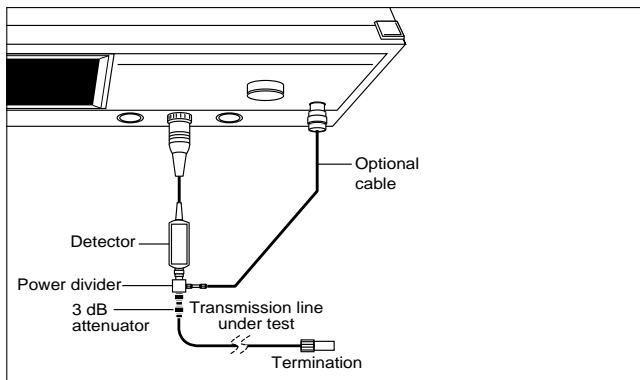

Common causes of antenna feed problems

- **Cable and waveguide problems**
 - Cable discontinuities
 - Moisture
 - Braid wire ground shield fault (appears as a notch filter)
 - Damaged/cut ground shields
 - Dielectric fault or narrowed dielectric diameter
 - Fasteners pinch cables
- **Connector problems**
 - Corroded connectors
 - Low quality connectors
 - Connector pin offset (poor mating contact)
- **Antenna problems**
 - Antenna out of specification
 - Antenna storm/shipping damage

Performance

• Preventing “ghost” faults

The 54100A uses a low harmonic source and high performance anti-aliasing software to prevent the display of false or “ghost” transmission line faults. This is a common problem when the end of the DUT is unterminated or damaged. Anritsu's precision components and low harmonic sources prevent “ghost” faults, assuring accurate, repeatable results.

• High dynamic range

The 54100A distance-to-fault software optimizes sensitivity and accuracy. For example, a precision termination is used during calibration to achieve industry leading dynamic range. If the termination is not of high quality, it will reflect some of the source energy rather than absorb it—causing errors in the measurement process. The use of a specialized discrete fourier transform rather than a more common fast fourier transform also improves low level sensitivity. Low source harmonics also ensure that fault indications are actual transmission line and not re-reflections of source harmonic energy.

Relative group delay

Optional relative group delay software identifies signal distortion caused by bandpass devices such as filters, receivers, power amplifiers, and up/down converters. Group delay is a key cause of high bit error rate (BER). Group delay is important for (1) CDMA and spread spectrum communications, (2) phase array radars, (3) high capacity satellite and terrestrial microwave links, and (4) PAL and HDTV television components and other RF systems sensitive to phase distortion. The 54100A saves time and expense by eliminating several pieces of expensive test equipment – combining the capabilities into a single, low cost test station. Manufacturing processes save re-test/re-tuning time by utilizing a single 54100A instead of two separate tuning stations – one for scalar transmission and return loss and the other for relative phase group delay. Furthermore, the 54100A can accurately test frequency conversion devices without the wideband reference converters required with vector network analyzers or microwave system analyzers.

Convertible SWR autotester

Convertible SWR autotesters reduce capital equipment and maintenance costs. A single convertible SWR autotester accurately measures the return loss or SWR of devices with SMA, 3.5 mm, or K connectors. Six interchangeable test port heads (male and female for each connector standard) are precision tuned to the convertible SWR autotester's internal bridge circuit.

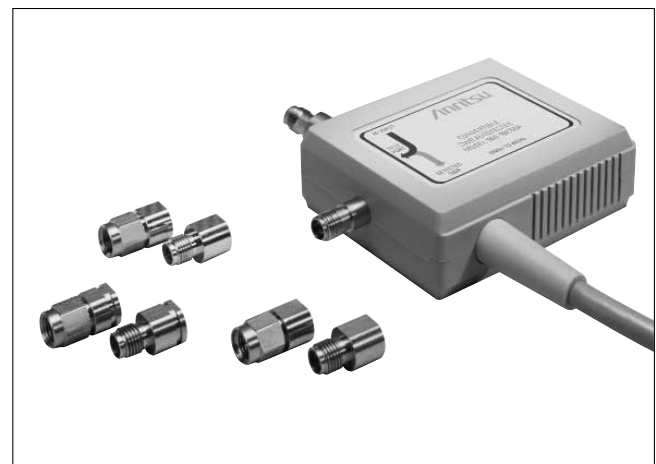

The 560-98C50 Convertible SWR Autotester improves test accuracy and reduces maintenance cost without using error prone test port adapters or connector savers.

The inexpensive test port heads save repair and calibration costs because they are interchangeable.

Measurement accuracy

• Transmission loss or gain measurement accuracy

Uncertainties from the frequency response of components are automatically subtracted from test data during the path calibration procedure. Overall accuracy is then:

$$\begin{aligned} &\text{Channel accuracy} \\ &+ \text{Mismatch uncertainty} \\ &+ \text{Distortion from source harmonics} \\ &\text{Transmission measurement accuracy} \end{aligned}$$

Effects of source, test device, SWR autotester, and detector mismatch can be significant. This mismatch uncertainty is minimized by the exceptionally low reflection characteristics of Wiltron's detectors, sources, and SWR autotesters. Anritsu's ultra low source harmonics maximize the accuracy.

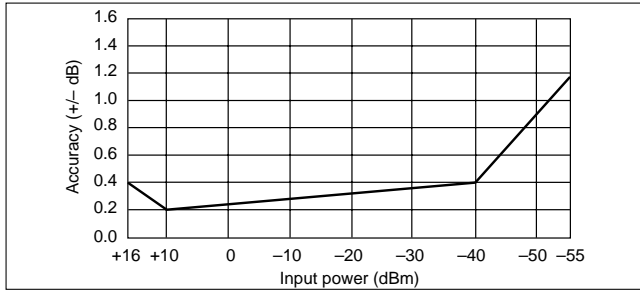

Channel accuracy (25°C)

• Distortion from source harmonics

Poor source harmonics cause large measurement errors. If the sweep range is set wide enough, at some point during the sweep, the harmonic will pass through the filter's pass band. Since the transmission detector is a broadband diode, the harmonic's signal power is measured. Thus, the analyzer displays the response of the harmonic in addition to the fundamental sweep frequency.

• Bandpass filter, distortion from source harmonics

If the source has a -30 dBc second harmonic and a -35 dBc third harmonic, at the beginning of the sweep, the harmonics pass through the filter's passband.

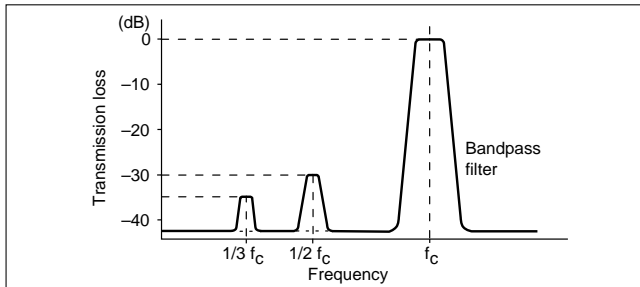

• Highpass filter, distortion from source harmonics

A highpass (or wide bandpass) filter responds similarly to the bandpass filter, except the presence of the harmonic in the filter's pass band limits the useful dynamic range of the analyzer.

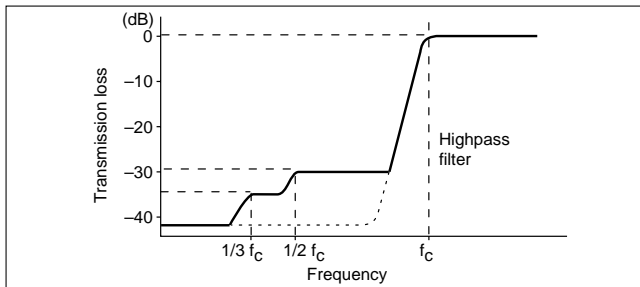

Return loss measurement accuracy

Uncertainties resulting from SWR autotester and source frequency response and from system open and short characteristics are subtracted automatically from test data. Overall accuracy is then:

$$\begin{aligned} &\text{Channel accuracy} \\ &+ \text{Autotester accuracy} \\ &+ \text{Distortion from source harmonics} \\ &\text{Return loss measurement accuracy} \end{aligned}$$

Autotester accuracy is composed of error due to directivity and error due to test port match. Unless the DUT has very poor return loss (high SWR), test port match will be negligible. When an adapter is used at the test port, use effective directivity to determine possible errors.

• Return loss accuracy due to directivity

Improved directivity decreases SWR (or return loss) measurement errors. The chart below identifies maximum error due to directivity.

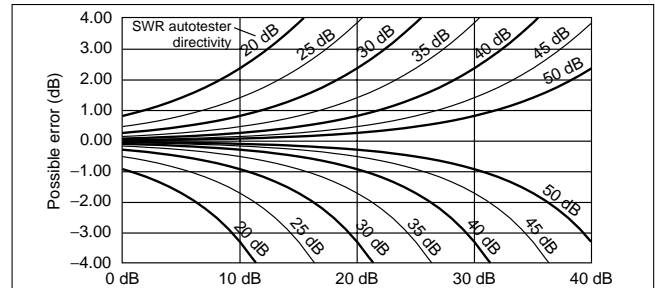

• Return loss accuracy due to effective directivity

Effective directivity is the reduction to directivity due to a test port adapter's SWR performance. Adapters severely degrade measurement directivity. The chart below shows the maximum degradation to a 40 dB directivity SWR autotester caused by test port adapters of varying quality.

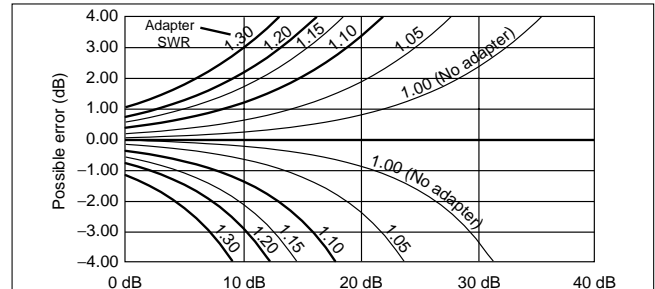

• Return loss accuracy due to source harmonics

Source harmonics are a significant source of return loss measurement uncertainty when testing banded devices such as filters, receivers, transmitters, power amplifiers, and antennas. In many cases, the harmonic errors are larger than uncertainty due to directivity, which is typically assumed to be the largest uncertainty factor.

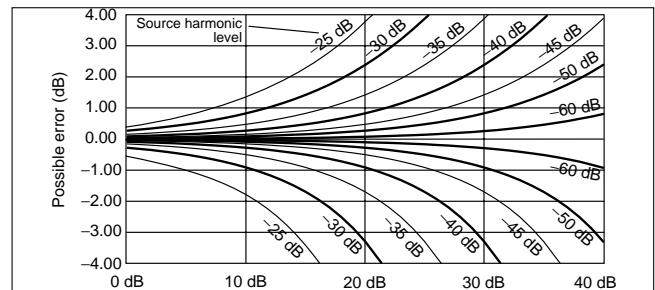

This chart assumes full reflections of a single source harmonic at the DUT input. Multiple harmonics can cause additional measurement uncertainty.

SCALAR NETWORK ANALYZER

56100A

10 MHz to 110 GHz

For Scalar Analysis



GPIB

The 56100A Scalar Network Analyzer measures insertion loss, insertion gain, or RF power with 76 dB dynamic range. Measure device match as return loss in dB or as SWR. Separate detectors can be used on all four inputs for multiple transmission measurements on duplexers or matched amplifiers.

Transmission and reflection measurements can be viewed simultaneously. Both traces can be scaled independently in dB, dBm, or SWR. Measurement of the ratio of two detector inputs may be applied to either channel for enhancing accuracy or for viewing differences. Built-in calibration allows subtraction of the unwanted transmission frequency response or the average of open/short reflections from either trace. A Volt Mode is available for displaying voltage (with volt mode adapter cable). A 0 to 10 volt sweep ramp output mode is also available.

Features

- Compatible with Anritsu 68 series, 69 series and MG3690 series signal generators
- 10 MHz to 110 GHz
- Four input channels
- Extensive cursor, markers, and limit lines
- Applications functions for improved productivity

SYNTHESIZED LEVEL GENERATOR

MG442A

10 Hz to 20 MHz

Compact and Lightweight



The MG442A is a compactly designed level generator with excellent stability and accuracy in frequency and output level. Because it is a synthesized level generator, its output frequency is highly stable. It has an excellent output level accuracy and a superb frequency response unrivaled by similar level generators.

The MG442A can be used for many applications as a measurement signal source where high frequency stability and level accuracy are required. The MG442A is best suited for use as a signal source for measuring baseband circuits from audio to video and various types of communications systems.

With its ease of operation and excellent portability, it can be utilized for many purposes as a fundamental measuring instrument in laboratories and manufacturing plants.

Features

- Universal output impedance
- Excellent operation: Digital frequency setting with 4 digits and output level with 3 digits
- Compact and lightweight

SYNTHESIZER/LEVEL GENERATOR

MG443B

10 Hz to 30 MHz

For Frequency Tracking with ML422C



GPIB

The MG443B is carefully designed. Its output level is highly stable, so it can be used for applications within the telecommunications industry without the need for a separate standard level meter.

Features

- Wide frequency range with 1 Hz resolution
- As many as 20 panel settings can be memorized; memory sweep capability
- High output level characteristics
Flatness: ± 0.07 dB (0° to $+50^\circ\text{C}$)
Level accuracy: ± 0.15 dB (0° to $+50^\circ\text{C}$)
- High precision output level setting of 0.01 dB
- Continuous output level variable within approximately 4.5 dB
- Variety of output impedances
Unbalanced: 50, 75 Ω
Balanced: 75, 135, 150, 600 Ω

SIGNAL GENERATOR

MG724E1/G1

6.3 to 7.8 GHz (MG724E1), 12 to 13 GHz (MG724G1)

For Maintaining and Adjusting Microwave Links



Custom-made product

The MG724E1/G1 are a compact lightweight microwave signal generator, designed for medium – and small – capacity microwave line repeater maintenance or adjustment. The instrument is best suited to measure AGC characteristics, squelch function, and signal-to-noise ratio. Its high signal purity and frequency stability also enable it to be used as a general-purpose signal source for microwave receiver adjustment on a production line.

Features

- High signal purity
- High frequency stability
- Wide output level range
- Low price
- Small and lightweight

PROGRAMMABLE ATTENUATOR

MN63A, MN65A, MN72A, MN64B

DC to 2 GHz DC to 6 GHz DC to 18 GHz DC to 1 GHz

For Configuring Automated Measurement Systems



MN63A

GPIB

The MN63A/65A/72A/64B provide GPIB as a standard feature and are suitable for automatic measuring system components used in R&D, inspection, or production. The 50 Ω models are available in three different frequency ranges, which can be selected to match the application for maximum economy. The attenuation calibration value is stored in the internal memory and can be uploaded to the system controller for checking against measured values, permitting a significant increase in system accuracy. A relative setting function is also provided, which allows measurement to be referenced to any arbitrary level. Rotary encoders are standard, allowing simple, smooth setting under manual control.

Features

- Wide frequency range
- High accuracy
- Long operating life
- High-speed switching
- Readout of attenuation calibration via GPIB
- Relative attenuation display function
- Rotary encoders for smooth manual setting

ISO9001/14000

IP Network, Wireless and Precision products contained in this catalogue are manufactured under a quality system and environment management system in conformance to the ISO international standard.

Factory name	Conformed standard	Qualification number	Qualified date	Qualification organization
Atsugi factory	ISO9001	JQA-0316	Nov. 15, 1993	Japan Quality Assurance Organization (JQA)
	ISO14001	JQA-EM0210	Aug. 28, 1998	
Tohoku Anritsu	ISO9001	JQA-0737	Dec. 28, 1994	
	ISO14001	JQA-EM0560	Oct. 22, 1999	
England factory	ISO9001	FS22679	May 24, 1999	BSI Quality Assurance
	ISO14001	EMS54120	Mar. 15, 2000	
U.S.A factory	ISO9001:2000	6495	Apr. 27, 1995	The Seal of National Quality Assurance Limited Registered to A2LA
	ISO/IEC 17025	2160.01	Mar. 18, 2004	

Quality and Reliability Assurance for Products

• Planning stage

Management resources are focused on measuring instruments related to growing fields such as mobile Internet, WDM and digital broadcasting, System solutions, precision measurement business and device businesses. New products are planned to provide solutions whenever required by users.

• Design stage

To realize a design with high-safety and high-reliability, several levels of design assessments are performed. Power consumption is reduced from the viewpoint of environment considerations, starting with evaluation of specifications, legal regulations and parts used. Evaluations are also implemented for improving the recycling ratio, and the design quality is improved.

Anritsu utilizes a design process that targets customer satisfaction.

• Evaluation stage

In addition to safety, reliability and environment considerations of test models for new products, functions and performance are verified by an operating environmental conditions test and operability, uncertainty, maintainability and flexibility of design are evaluated fully. After passing these tests, the products can be commercialized.

• Manufacturing and inspection stages

Based on our policy, "post-processing is the customer," the product is manufactured by experienced employees according to the workmanship standards. In the adjustment and inspection stage, automatic measurement is promoted. An expert will be in charge of the adjustment if high-skilled adjustment is required.

• After sold

In each service department, traceability assurance by calibrations based on high-technical capabilities, as well as rapid repair and preventive maintenance are performed.

Parts standardization and improving activities for quality and reliability

For parts generally used in each measuring instrument, quality improvement and standardization are actively promoted. All field data is analyzed, arranged and completely made known to each department while required actions are taken for reliability improvement. In addition, failure rate, MTBF observation and parts failure rate are calculated based on this information.

Traceability assurance

As defined in the International Vocabulary of Basic and General Terms in Metrology (VIM; 1993), traceability is defined as "the property of the result of a measurement or the value of a standard whereby it can be related to stated references, usually national or international standards, through an unbroken chain of comparisons." Anritsu's system to ensure traceability is shown below. Measurements made by Anritsu's laboratory's are traceable to national, international, or intrinsic standards, where such standards are available.

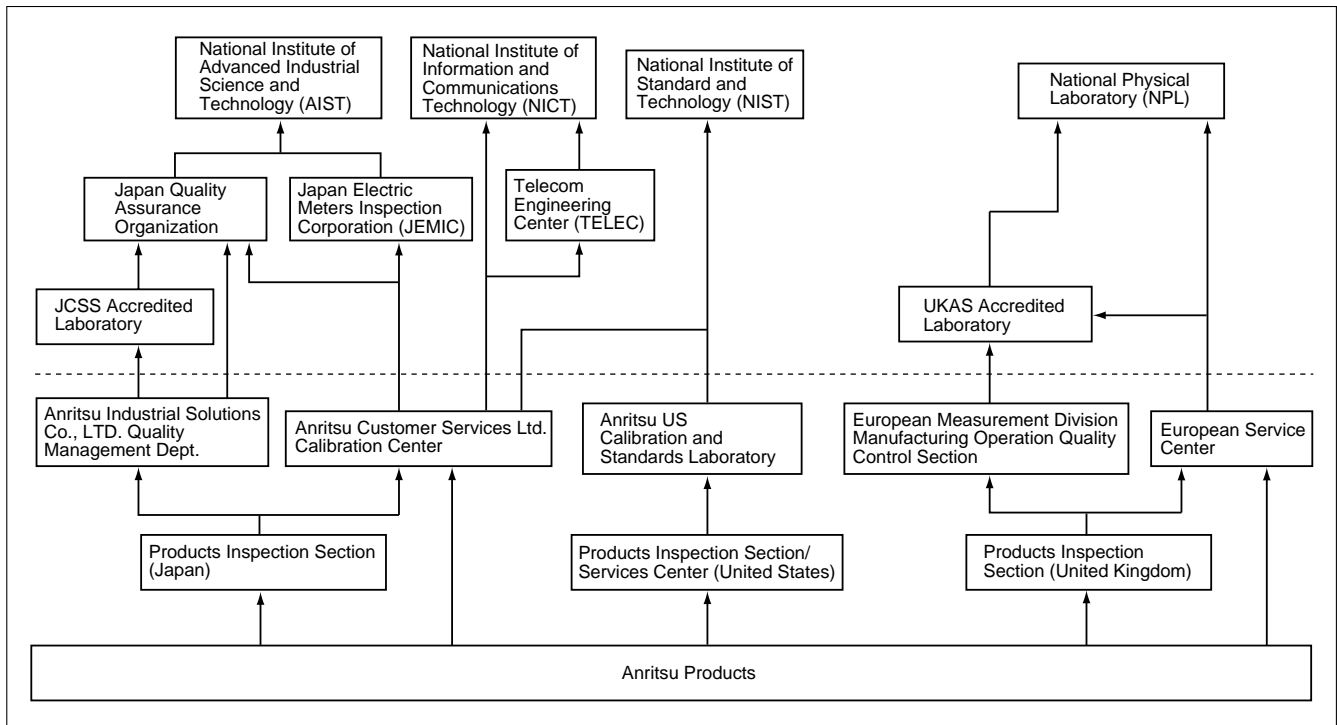

ANRITSU CORPORATION