

Bausch & Lomb

StereoZoom

Microscopes



Bausch & Lomb Incorporated

Rochester 2, N.Y., U.S.A.

Bausch & Lomb Stereomicroscopes with STEREOZOOM[®]

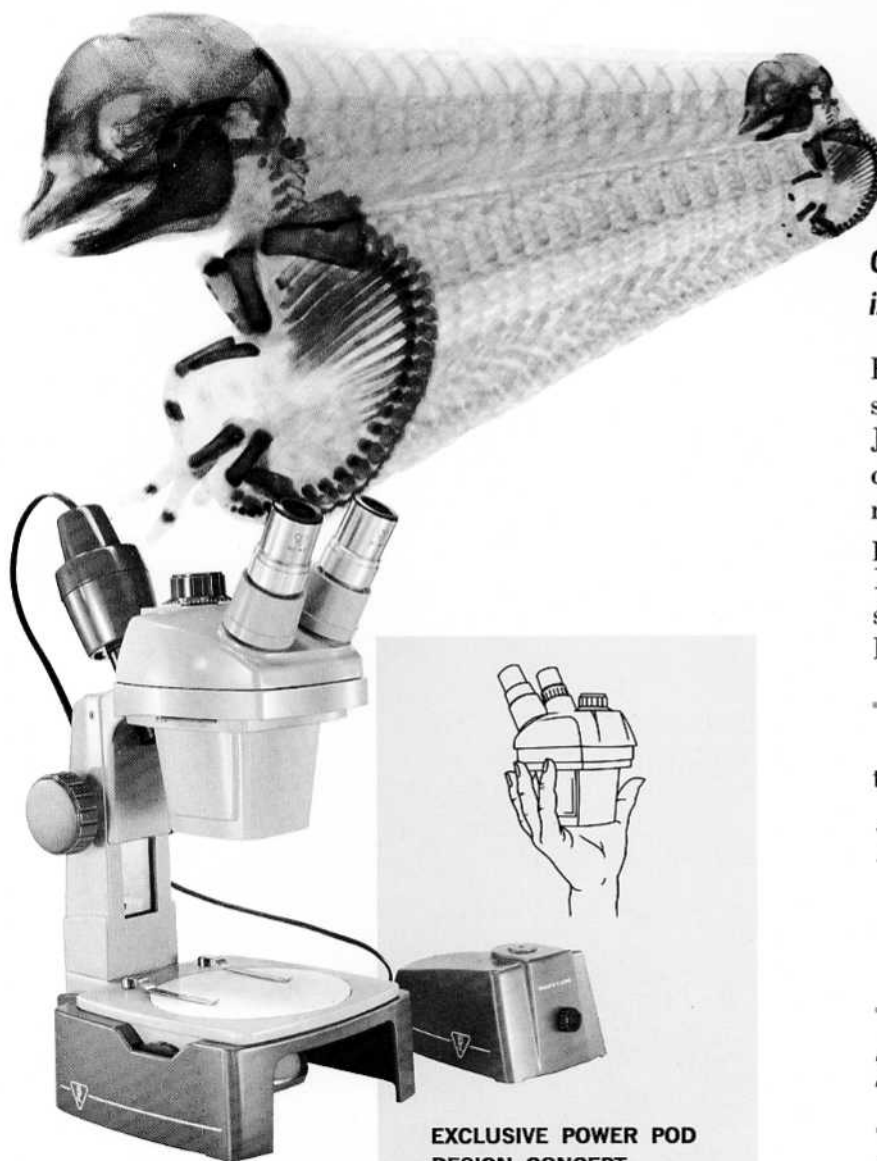

Continuously Variable Magnification Optics in sealed Power Pod

Here's a completely new optical concept to speed and simplify work requiring 3D views. Just turn the magnification knob and watch the crisp stereo image zoom to the *exact* size you need. Not just a few fixed powers, but *any* power within the wide stereo ranges (3.5 \times -120 \times). The newest advance in three dimensional microscope design... exclusive with Bausch & Lomb.

The range of magnification attainable is determined by choice of:

1	a. Power Pods—Four Models Two StereoZoom continuously variable models are available.	1 \times thru 2 \times 0.7 \times thru 3 \times
	b. Two fixed models are available.	1 \times 2 \times
2	Wide Field Eyepieces Three Magnifications	10 \times 15 \times 20 \times
3	Supplementary Lenses Two Magnifications	0.5 \times 2 \times

EXCLUSIVE POWER POD DESIGN CONCEPT

- Sealed to prevent dust and foreign matter from entering optical system!
- No nosepiece!
- No objectives to change!
- No image jump!
- No image blackout!

Since TOTAL MAGNIFICATION equals POWER POD times EYEPIECES times SUPPLEMENTARY LENS, when used, the extended range of magnification possible is easily determined. The limits are 3.5 \times thru 120 \times .

©StereoZoom, Registered, Bausch & Lomb

Beginning a New Tradition in Microscope Design

The optical design of these new instruments is a complete departure from the conventional methods used to achieve magnified, three-dimensional images. All optical elements are completely enclosed in a unitized Power Pod, sealed against dust and all other foreign material. Images are always crisp, and brilliant. The finest details in the object being viewed are quickly and easily resolved, assuring continuous, accurate, speedy work flow.

Dual mirrors erect and relay the enlarged images formed by dual magnifying lenses, eliminating prisms and the attendant possibility of prism shift. These first-surface mirrors have an enhanced aluminum coating that increases light reflection and maintains its polished brilliance.

The enclosure containing the optical elements and heretofore often referred to as a "body" or "Optical Head" is so entirely different in concept that these terms no longer apply. Hence, the name "Power Pod"—to signify a complete, self-sufficient unit that is, in essence, the microscope. All Power Pods fit all stands, and are instantly interchangeable from one type of stand to another, can be reversed and in some cases rotated. Such complete versatility keeps the user constantly prepared to meet all needs quickly without heavy investment in additional instruments.

Optics are completely enclosed within the Power Pod on a smoothly functioning, long-wearing cam arrangement in the StereoZoom continuously variable magnification models—permanently fixed in the constant magnification models. There are no objectives to misplace, scratch or break—no sliding, revolving, or rotating drum nosepieces to get out of order or to cause "image blackout" when changing from one magnification to another.

This "phantom" illustration of the 0.7× thru 3× continuously variable Power Pod, shows many optical-mechanical components within the sealed body. While every part in the system is of ample size to assure long life with no maintenance problems, the entire assembly is a marvel of compactness. Turning the StereoZoom Dial actuates shafts and gears which determine spacing of lenses to provide continuously variable magnification.

The StereoZoom Dial on both the 0.7× thru 3× and 1× thru 2× continuously Variable Power models is graduated in magnification increments.

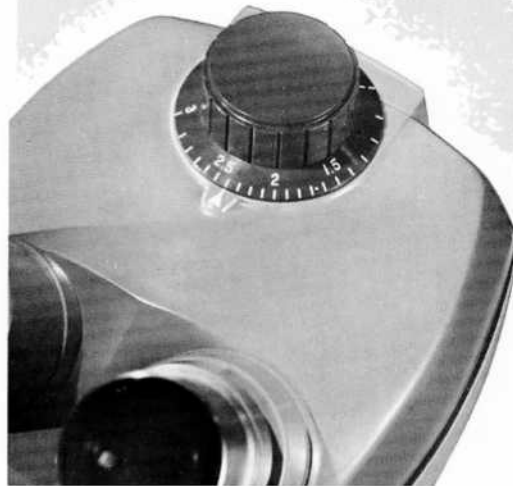



0.5× and 2× Lens Attachments are available. A Clear Glass Shield is furnished on Fixed Power models and optional at extra cost on Variable Power models.

Flat Fields — No Loss of Depth

Because the optical arrangement consists of two complete microscope systems, edge-to-edge flatness of field is assured. There is none of the annoying curvature of field that destroys the 3-D effect and results in inaccurate work and costly rejects. True stereopsis is maintained at all magnifications. No refocusing is necessary when changing from one to another.

Working distance is a constant 4 inches except when lens attachments are used. The 2× attachment shortens working distance to 1½ inches, the 0.5× attachment extends it to 7 inches. Obviously, the 0.5× attachment can be used only with those models that permit 7 inches of working distance — models in the S, SK, K, and KT series.

In addition to long working distance and flat fields, these instruments also provide wide fields of view enabling users to manipulate tools or dissecting instruments with speed and precision. See pages 26 and 27 for a table of magnifications and field sizes.

Longer Eye-Relief Eyepieces

In keeping with the many other accuracy, time-saving and comfort features of these new instruments, the entirely new, wide-field eyepieces provide a margin of eye-relief that assures comfortable, efficient viewing. They provide wide fields with the sharpest possible focus from center to outside edge, without the “peep-hole gazing” effect of less modern instruments. They can be supplied in 10×, 15× or 20×. The 10× eyepieces with exceptionally long eye-relief are ideal for those who wear eyeglasses. Simplicity of mechanical design permits quick insertion of standard, or special

Long Eye Relief Wide Field Eyepieces come in 10×, 15× and 20× magnifications and permit comfortable viewing even when wearing glasses.



micrometer scales for precise measuring work.

To eliminate bothersome stray light, eyeguards are regularly supplied for use with these eyepieces without extra cost. For those who do not wear eyeglasses, these eyeguards serve to quickly position the eyes at the correct distance from the eyepieces.

Sharpest Possible Images

Whenever the requirements call for the very finest optical elements science can provide, Bausch & Lomb optics are specified. And in this new line of StereoZoom Microscopes, these optics assure sharpest rendition of detail in the most complex material. To insure elimination of internal reflections and flare, thus providing more light, better contrast and definition, all optical elements are anti-reflection coated with Bausch & Lomb BALCOTE.

Inclined Eyepiece Tubes for Comfort and Efficiency

All Power Pods are supplied with eyepiece tubes inclined at a convenient angle. The operator works comfortably and efficiently, fatigue-free for long periods of observation.

Synchronized Eye-Spacing Adjustment

Eyepiece tubes are easily adjusted to conform to individual eye-spacing from 50mm to 80mm. They are synchronized with a large, smoothly acting linkage completely enclosed within the Power Pod—movement of one moves the other the same degree, maintaining the same horizontal axis. Spacing remains as set until purposely changed. This adjustment will not affect focus nor will it destroy calibration during measuring applications.

Inclined Eyepieces make for relaxed, most efficient viewing. Here shown with eyeguards, regularly supplied with all wide field eyepieces at no extra cost.



Acuity Equalizer

One eyepiece can be independently focused to compensate for the difference in visual acuity between the eyes. A fine screw thread permits precise equalization of focus between the left and right eyes.

Instantly Reversible Power Pods

All Power Pods are quickly reversible in any type stand simply by opening two spring clips, lifting the Pod out, and replacing it, so that the eyepieces are facing in the opposite direction. Optics are mounted to withstand everyday use — and abuse.

A rotary arm permitting 360° rotation is available for models in the S, K and KT series and regularly supplied in the SK series. This is especially useful when examining objects too heavy or bulky to be conveniently handled.

Modern Functional Stands

The simple, rigidly-strong, and well-balanced stands of these instruments assure vibration-free support for the Power Pods. They can be used on the production line alongside machinery without resultant image flutter.

There is an immediate and complete response without sign of lag or drag when focusing B&L StereoZoom Microscopes. The focusing rack and pinion gears are chrome-plated steel, making them extremely hard and corrosion-resistant, thus adding considerably to their long-wearing qualities. The rack is extra wide, providing a greater bearing surface and thus assuring more positive focusing. Vibrations cannot cause the stereomicroscope to creep or drift out of focus.

Focusing knobs are also extra large for positive handling, ease of manipulation and critical focusing. These instruments will always



Power Pods are instantly reversible to allow for specific requirements of work to be done.

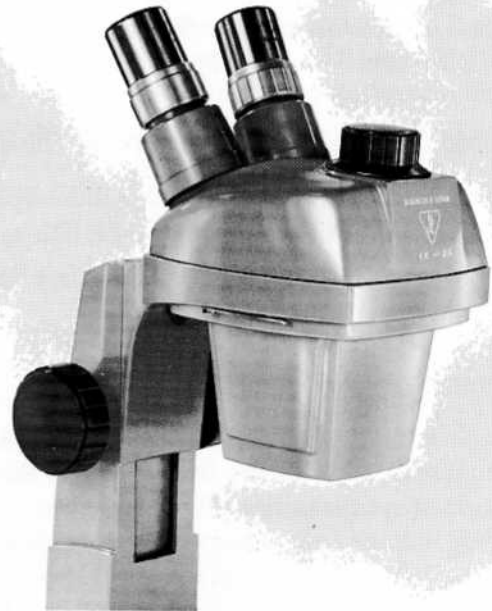

focus as easily and precisely as the day they passed Bausch & Lomb rigid inspection standards. Tension of the focusing knob can be quickly adjusted to suit the user.

Wide stages accommodate even the larger parts or specimens to provide an extended range of usefulness for these instruments.

Models Exactly Fitted to Your Job

Choosing a model that is custom tailored to your present application and which can be quickly adapted to future requirements is simplicity itself. Six basic stands are available which will accept any one of the 4 Power Pods, to make up 24 different models.

These are divided into 6 series — A, B, K, KT, S and SK — each series consisting of 4 models made up from a basic stand and one of the 4 Power Pods.

Series A

For examination of opaque specimens. Stand has a port at the top of the microscope arm for insertion of the B&L Nicholas Illuminator. Supplied with newly designed, scratch and reagent resistant contrast plate — black on one side, white on the other.

Series B

Same stand as in Series A with the addition of a locked-on, removable base for transmitted light work. Supplied with a clear glass stage plate. Contrast plate can be furnished at slight added cost for optimum efficiency when doing opaque work.

In the base is a concave mirror with a diffusing reflector on the reverse side, rotatable by either of two dials recessed in the base for best possible reflection of the light source. The mir-



The Series A. Here fitted with Reflector Illuminator.

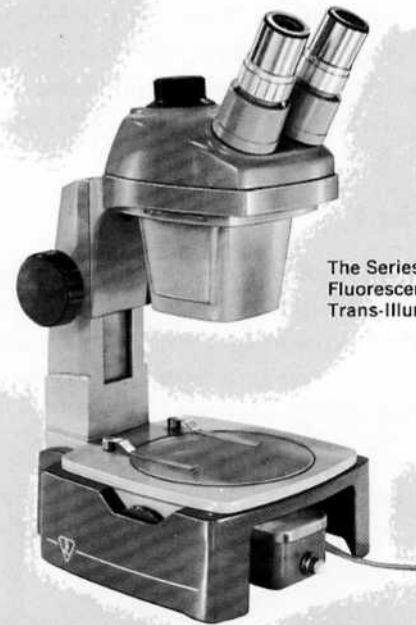

The Series B. Showing Fluorescent Illuminator in Trans-Illumination Base.

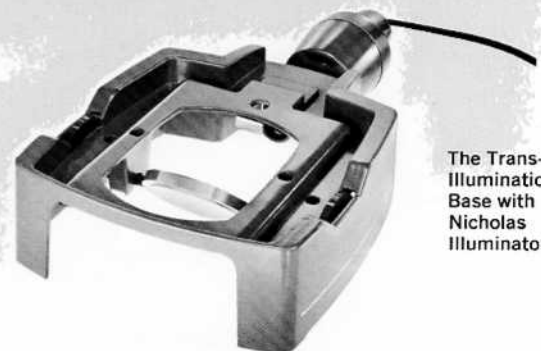

The Trans-Illumination Base with Nicholas Illuminator.



The Series K



The Series KT

ror is easily removable for substitution of the B&L Fluorescent Illuminator which clips into the base in automatic centration. Or if preferred, a port at the rear of the base permits insertion of the Nicholas Illuminator for use in conjunction with the mirror, to provide greater intensity of illumination when working with dense material.

Series K

Heavy, recessed cast base, an inclinable joint and two continuously adjustable slides providing extra long working range, make instruments in this series particularly well suited to industrial applications.

Series KT

A 12" x 16" Composition Baseboard, plus an inclinable joint and the extra vertical travel provided by the additional slide feature on K models. For examination of large, opaque objects.

Series S

For use in applications requiring greater flexibility of movement during opaque examinations than provided by instruments in the A, B, K or KT series.

Massive cast base assures rigid stability even with horizontal arm supporting Power Pod, fully extended. Horizontal arm, adjust-

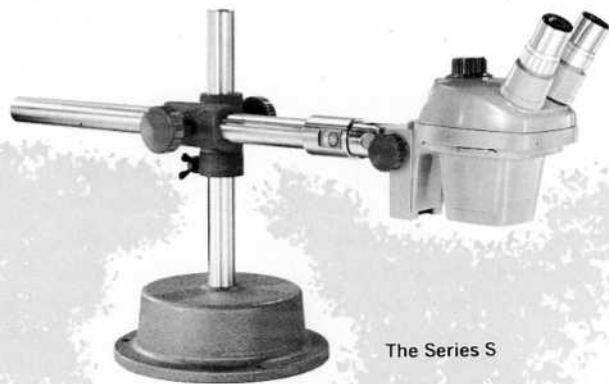

The Series S

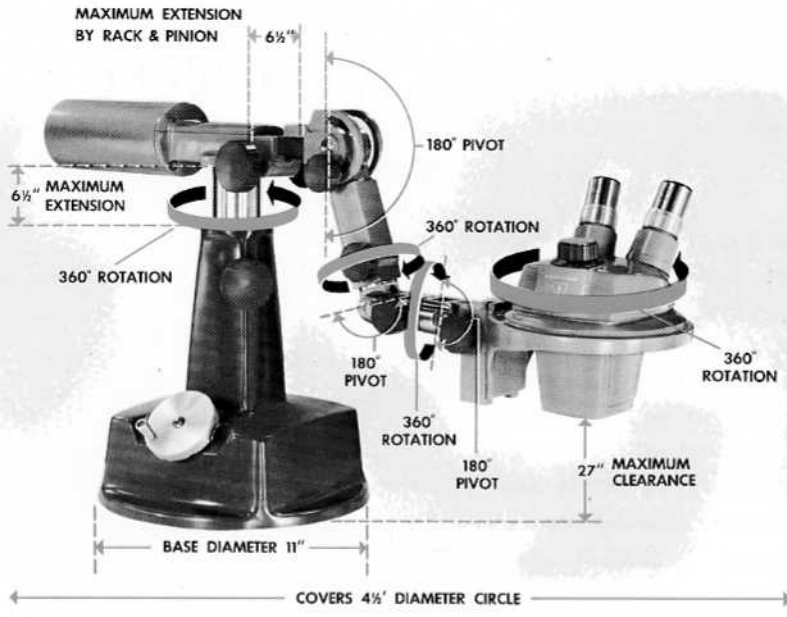

The Series SK has 7 pivoting or rotating actions.

able up or down on heavy steel shaft, can be turned through a complete circle. Tilting pivot joint secures the arm to the rack and pinion focusing mechanism to permit convenient examination of sloping surfaces.

Series SK

Providing complete flexibility for examining opaque objects in *any plane*. 360° rotatable ring for support of the Power Pod. Balanced, horizontal rotatable arm with rack and pinion radial adjustment; fitted with 5 tension joints and provided with 3 pivoting, 4 rotating and 3 linear actions for universal adjustment in any plane. Heavy cast base with vertical column adjustable in height by ball-bearing nut mechanism actuated by handle and brake.

Special Depth-Measuring Model

This instrument makes use of the observer's sense of depth perception to make accurate measurements of surface details without physically touching the object. Two identical stereo reticles cause image fusion at a definite plane in space. Depth is measured with a dial indicator which reads the travel of the focusing mechanism. Dial range is 1" with least reading of 0.001". Repeatability is to within $\pm .0004$ ".

The Better for You to See With

Given the finest microscope in the world, its efficiency is considerably reduced by inadequate or improper illumination. The quality of images provided by this new line of stereomicroscopes can be fully realized only by using illuminators developed especially for them. There are three of these and they are pictured and described on pages 24-26.

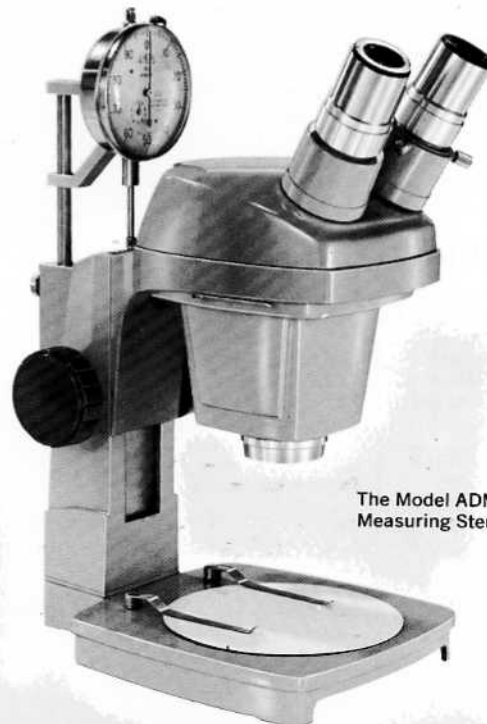

The Model ADM Depth Measuring Stereomicroscope.

THE SERIES

A

STEREOZOOM MICROSCOPE

For opaque objects

Bausch & Lomb StereoZoom Microscope, Balcoted; sealed Power Pod with inclined eyepieces, reversible, synchronized interpupillary distance adjustment, acuity equalizer; continuous positive focus by extra wide rack and pinion; constant 4" working distance; 4 locations for integral illumination; large stage with clips and reversible black and white contrast plate; 10× paired wide field eyepieces with eyeguards; plastic dust cover; reference and maintenance manual; corrugated carton; specific models as listed below:

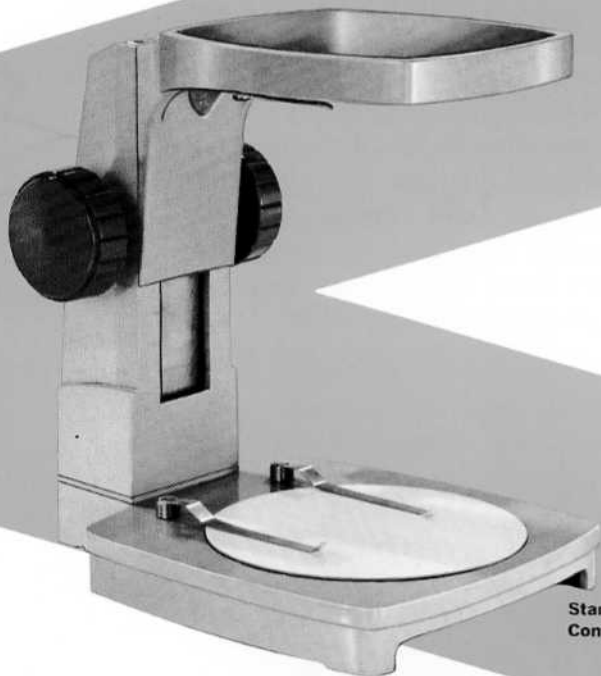

Stand—31-26-88 with
Contrast Plate—31-26-87



1× Fixed Power Pod—31-26-91
2× Fixed Power Pod—31-26-92



0.7× thru 3× StereoZoom Power Pod—31-26-94
1× thru 2× StereoZoom Power Pod—31-26-93

OPTICAL SPECIFICATIONS

Total magnifications as shown can be changed by using other eyepieces or lens attachments. See pages 26-27.

Cat. No.	Model	Description
31-26-29-01	Model AFB-1	1× Fixed Power Pod (total magnification 10×)
31-26-29-02	Model AFB-2	2× Fixed Power Pod (total magnification 20×)
31-26-29-12	Model AVB-12	1× thru 2× StereoZoom Variable Power Pod (total magnification 10× thru 20×)
31-26-29-73	Model AVB-73	0.7× thru 3× StereoZoom Variable Power Pod (total magnification 7× thru 30×)

Bausch & Lomb Series A

StereoZoom Microscopes



Model AFB-1. 1 \times —31-26-29-01
 Model AFB-2. 2 \times —31-26-29-02

ILLUMINATORS—Harmonizing Design

Cat. No.	Description
31-33-53	Nicholas with adjustable transformer
31-33-56	Nicholas with fixed transformer
31-33-36	Fluorescent
31-33-24-01	Reflector
31-34-83	Vertical



Model AVB-73. 0.7 \times thru 3 \times —31-26-29-73
 Model AVB-12. 1 \times thru 2 \times —31-26-29-12

See pages 24-26 for complete descriptions of illuminators.

THE SERIES **B** STEREOZOOM MICROSCOPE

For opaque and transparent objects

Bausch & Lomb StereoZoom Microscope, Balcoted; sealed Power Pod with inclined eyepieces, reversible, synchronized interpupillary distance adjustment, acuity equalizer; continuous positive focus by extra wide matched rack and pinion; constant 4" working distance; 5 locations for integral illumination; large stage with clips and clear glass plate; locked on removable base with substage illuminator port, concave mirror with angle adjustment controls; 10× paired wide field eyepieces with eyeguards; plastic dust cover; reference and maintenance manual; corrugated carton; specific models as listed below:

1× Fixed Power Pod—31-26-91
2× Fixed Power Pod—31-26-92

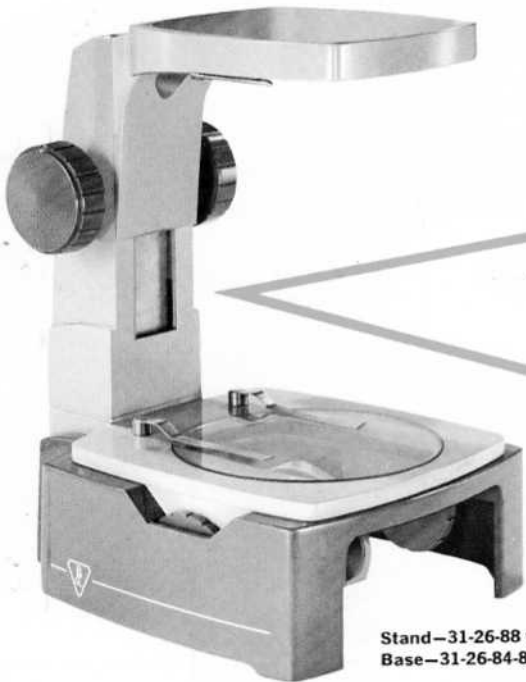

Stand—31-26-88 with
Base—31-26-84-86



0.7× thru 3× StereoZoom Power Pod—31-26-94
1× thru 2× StereoZoom Power Pod—31-26-93

OPTICAL SPECIFICATIONS

Total magnifications as shown can be changed by using other eyepieces or lens attachments. See pages 26-27.

Cat. No.	Model	Description
31-26-30-01	Model BFB-1	1× Fixed Power Pod (total magnification 10×)
31-26-30-02	Model BFB-2	2× Fixed Power Pod (total magnification 20×)
31-26-30-12	Model BVB-12	1× thru 2× StereoZoom Variable Power Pod (total magnification 10× thru 20×)
31-26-30-73	Model BVB-73	0.7× thru 3× StereoZoom Variable Power Pod (total magnification 7× thru 30×)



Model BFB-1. 1 \times -31-26-30-01
Model BFB-2. 2 \times -31-26-30-02



Model BVB-73. 0.7 \times thru 3 \times -31-26-30-73
Model BVB-12. 1 \times thru 2 \times -31-26-30-12

ILLUMINATORS—Harmonizing Design

Cat. No.	Description
31-33-53	Nicholas with adjustable transformer
31-33-56	Nicholas with fixed transformer
31-33-36	Fluorescent
31-33-24-01	Reflector
31-34-83	Vertical

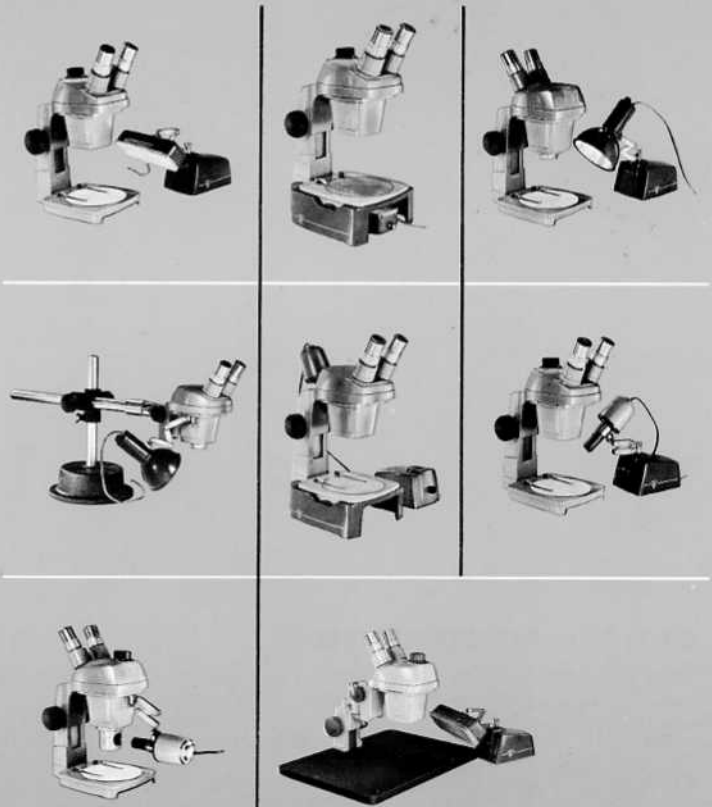

See pages 24-26 for complete descriptions of illuminators.

THE SERIES

K

STEREOZOOM MICROSCOPE

For opaque objects

Bausch & Lomb StereoZoom Microscope, Balcoted; sealed Power Pod with inclined eyepieces, reversible, synchronized interpupillary distance adjustment, acuity equalizer; continuous positive focus by extra wide matched rack and pinion; supplementary rack and pinion focus on continuously adjustable slide, inclinable and rotatable for greater working range; heavy recessed cast base; constant 4" working distance; 4 locations for integral illumination; 10× paired wide field eyepieces with eyeguards; plastic dust cover; reference and maintenance manual; corrugated carton; specific models as listed below:



1× Fixed Power Pod—31-26-91
2× Fixed Power Pod—31-26-92

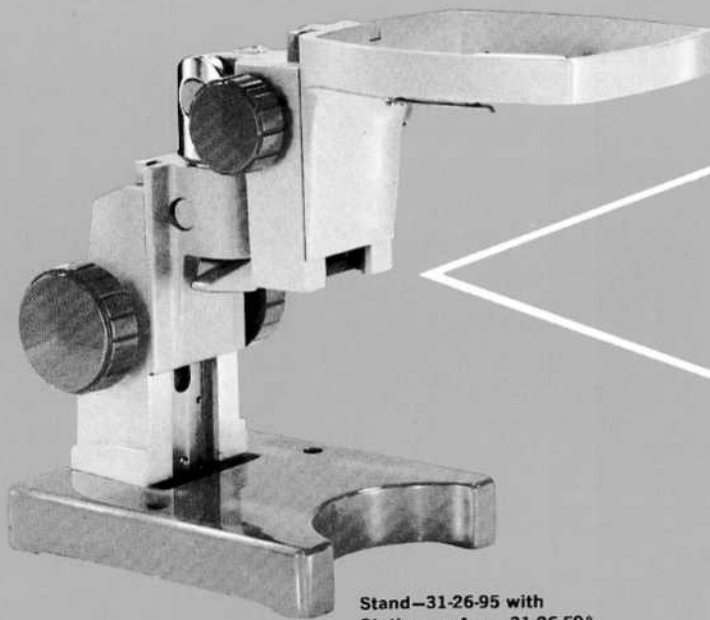

Stand—31-26-95 with
Stationary Arm—31-26-59*



0.7× thru 3× StereoZoom Power Pod—31-26-94
1× thru 2× StereoZoom Power Pod—31-26-93

OPTICAL SPECIFICATIONS

Total magnifications as shown can be changed by using other eyepieces or lens attachments. See pages 26-27.

Cat. No.	Model	Description
31-26-39-01	Model KFB-1	1× Fixed Power Pod (total magnification 10×)
31-26-39-02	Model KFB-2	2× Fixed Power Pod (total magnification 20×)
31-26-39-12	Model KVB-12	1× thru 2× StereoZoom Variable Power Pod (total magnification 10× thru 20×)
31-26-39-73	Model KVB-73	0.7× thru 3× StereoZoom Variable Power Pod (total magnification 7× thru 30×)

*31-26-90 Rotatable Arm in place of 31-26-59 Stationary Arm available at additional cost.



Model KFB-1. 1 \times -31-26-39-01
Model KFB-2. 2 \times -31-26-39-02

ILLUMINATORS—Harmonizing Design

Cat. No.	Description
31-33-53	Nicholas with adjustable transformer
31-33-56	Nicholas with fixed transformer
31-33-36	Fluorescent
31-33-24-01	Reflector
31-34-83	Vertical



Model KVB-73. 0.7 \times thru 3 \times -31-26-39-73
Model KVB-12. 1 \times thru 2 \times -31-26-39-12

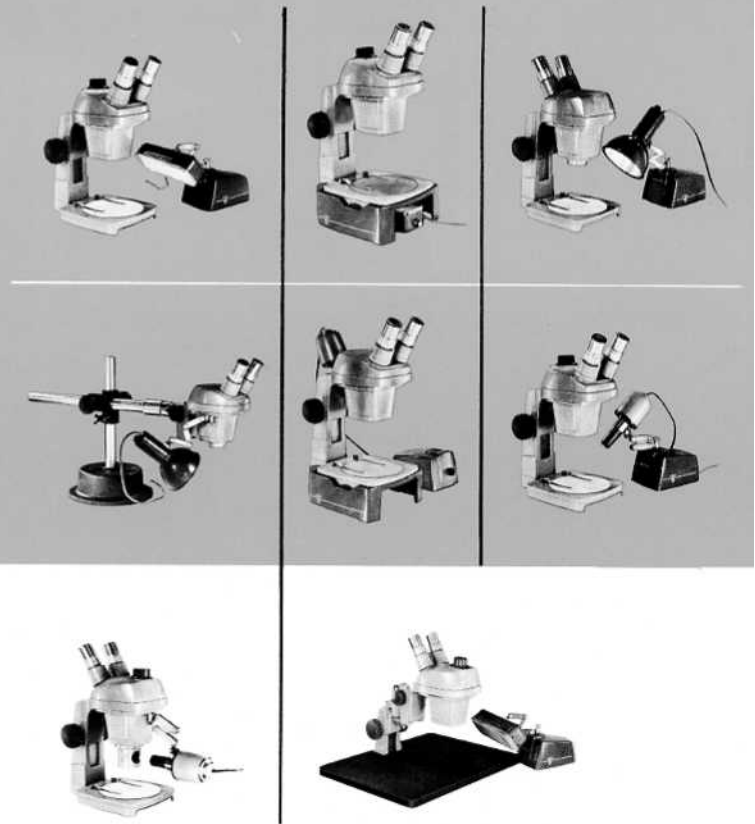

See pages 24-26 for complete descriptions of illuminators.

THE SERIES **KT** STEREOZOOM MICROSCOPE

For examination of opaque objects in any plane

Bausch & Lomb StereoZoom Microscope, Balcoted; sealed Power Pod with inclined eyepieces, reversible, synchronized interpupillary distance adjustment, acuity equalizer; continuous positive focus by extra wide matched rack and pinion; supplementary rack and pinion focus on continuously adjustable slide, inclinable and rotatable for greater working range; 12" x 16" fibre composition baseboard; constant 4" working distance; 4 locations for integral illumination; 10 \times paired wide field eyepieces with eyeguards; plastic dust cover; reference and maintenance manual; corrugated carton; specific models as listed below:



1 \times Fixed Power Pod – 31-26-91
2 \times Fixed Power Pod – 31-26-92

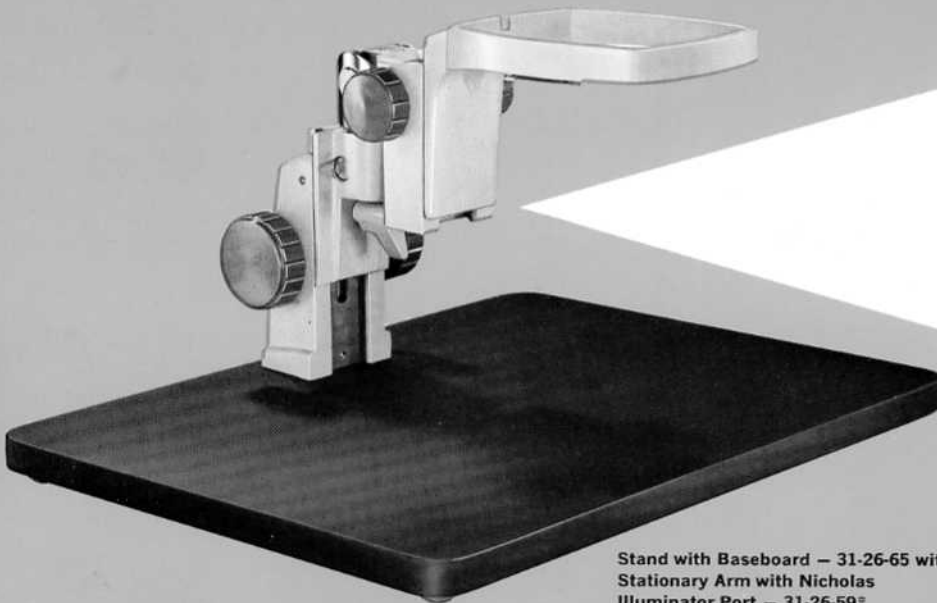

Stand with Baseboard – 31-26-65 with
Stationary Arm with Nicholas
Illuminator Port – 31-26-59*



0.7 \times thru 3 \times StereoZoom Power Pod – 31-26-94
1 \times thru 2 \times StereoZoom Power Pod – 31-26-93

OPTICAL SPECIFICATIONS

Total magnifications as shown can be changed by using other eyepieces or lens attachments. See pages 26-27.

Cat. No.	Model	Description
31-26-37-01	Model KTFB-1	1 \times Fixed Power Pod (total magnification 10 \times)
31-26-37-02	Model KTFB-2	2 \times Fixed Power Pod (total magnification 20 \times)
31-26-37-12	Model KTVB-12	1 \times thru 2 \times StereoZoom Variable Power Pod (total magnification 10 \times thru 20 \times)
31-26-37-73	Model KTVB-73	0.7 \times thru 3 \times StereoZoom Variable Power Pod (total magnification 7 \times thru 30 \times)

*31-26-90 Rotatable Arm in place of 31-26-59 Stationary Arm available at additional cost.

Bausch & Lomb Series **KT**
StereoZoom Microscopes

Model KTFB-1. 1X - 31-26-37-01
Model KTFB-2. 2X - 31-26-37-02

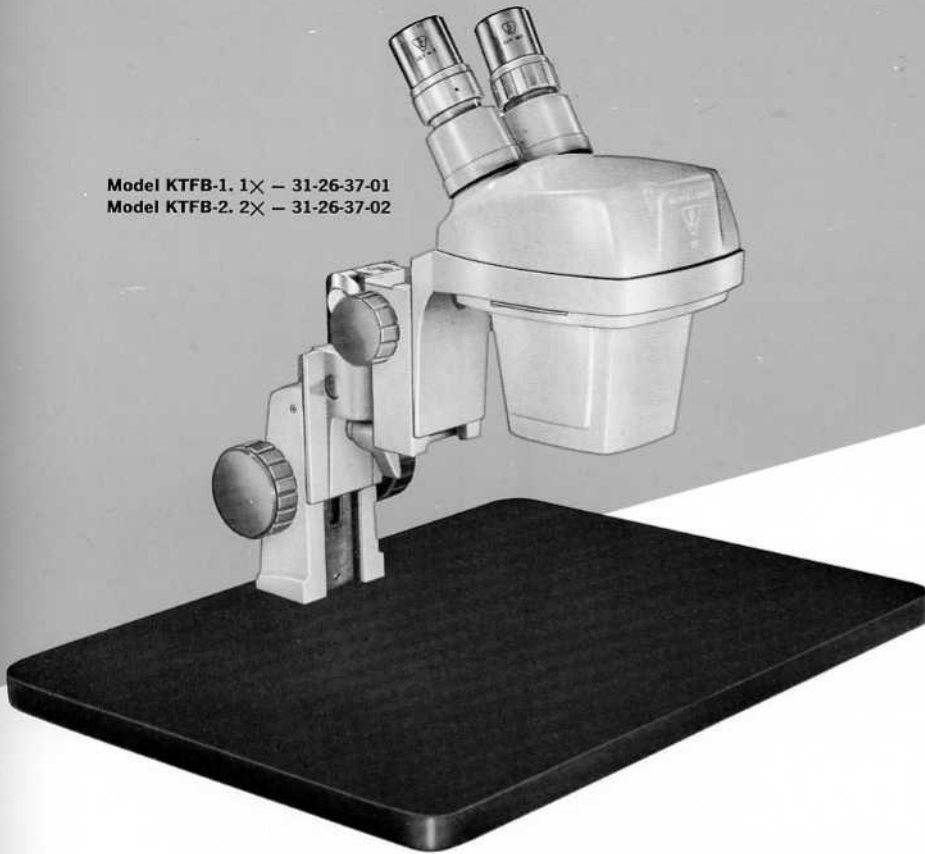

ILLUMINATORS—Harmonizing Design

Cat. No.	Description
31-33-53	Nicholas with adjustable transformer
31-33-56	Nicholas with fixed transformer
31-33-36	Fluorescent
31-33-24-01	Reflector
31-34-83	Vertical



Model KTVB-73.
0.7X thru 3X - 31-26-37-73
Model KTVB-12.
1X thru 2X - 31-26-37-12

See pages 24-26 for complete descriptions of illuminators.

THE SERIES S STEREOZOOM MICROSCOPE

For opaque objects

Bausch & Lomb StereoZoom Microscope, Balcoted; sealed Power Pod with inclined eyepieces, reversible, synchronized interpupillary distance adjustment, acuity equalizer; continuous positive focus by extra wide matched rack and pinion arm insertable in either of two positions on rotating horizontal tube with tilting pivot joint; height adjustment by safety ring clamp and locking knob on vertical post; heavy cast iron base; constant 4" working distance; 4 locations for integral illumination; 10× paired wide field eyepieces with eyeguards; plastic dust cover; reference and maintenance manual; corrugated carton; specific models as listed below:

1× Fixed Power Pod—31-26-91
2× Fixed Power Pod—31-26-92

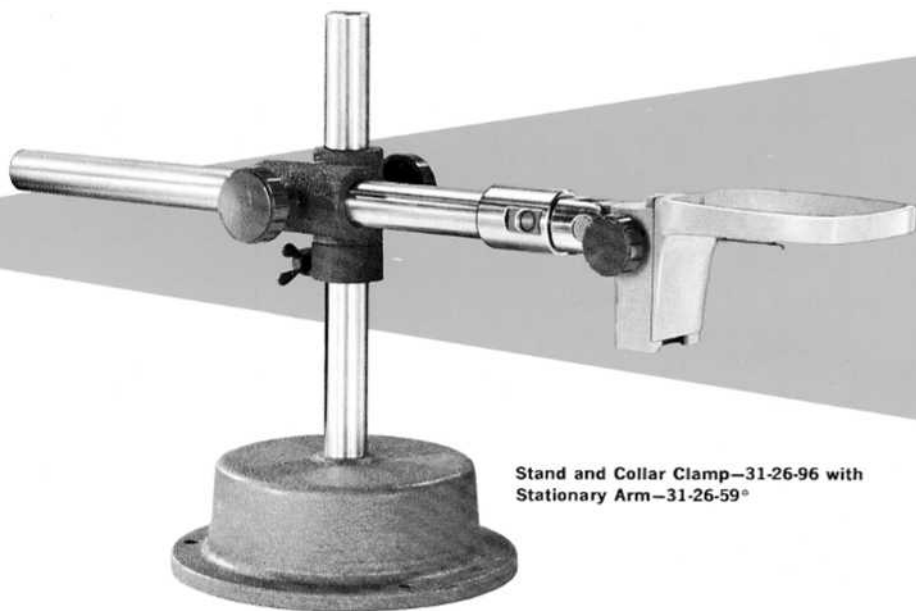

Stand and Collar Clamp—31-26-96 with Stationary Arm—31-26-59*



0.7× thru 3× StereoZoom Power Pod—31-26-94
1× thru 2× StereoZoom Power Pod—31-26-93

OPTICAL SPECIFICATIONS

Total magnifications as shown can be changed by using other eyepieces or lens attachments. See pages 26-27.

Cat. No.	Model	Description
31-26-40-01	Model SFB-1	1× Fixed Power Pod (total magnification 10×)
31-26-40-02	Model SFB-2	2× Fixed Power Pod (total magnification 20×)
31-26-40-12	Model SVB-12	1× thru 2× StereoZoom Variable Power Pod (total magnification 10× thru 20×)
31-26-40-73	Model SVB-73	0.7× thru 3× StereoZoom Variable Power Pod (total magnification 7× thru 30×)

*31-26-90 Rotatable Arm in place of 31-26-59 Stationary Arm available at additional cost.

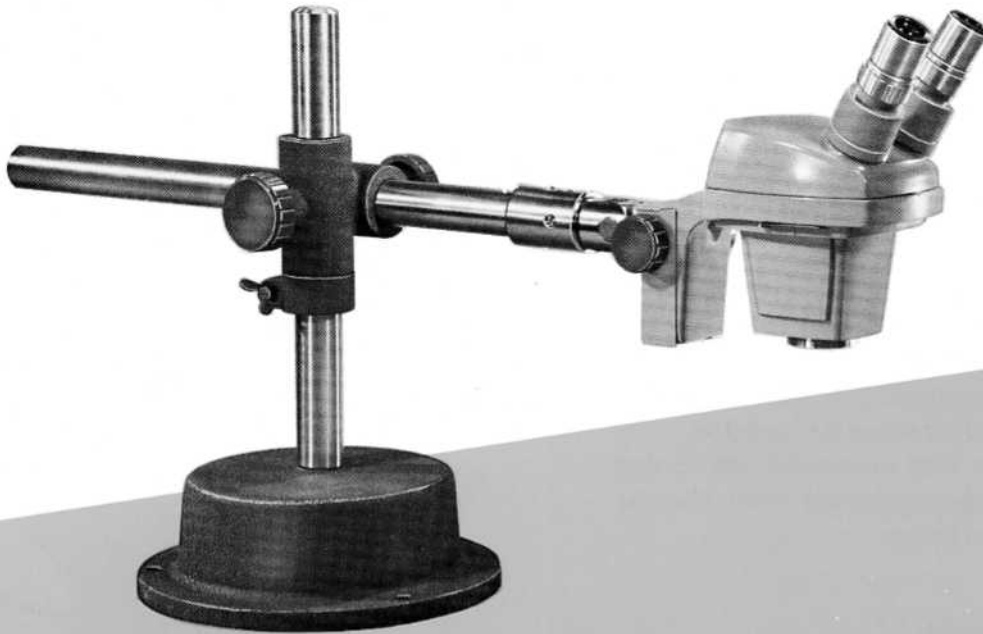

Model SFB-1. 1X-31-26-40-01
Model SFB-2. 2X-31-26-40-02



ILLUMINATORS—Harmonizing Design

Cat. No.	Description
31-33-53	Nicholas with adjustable transformer
31-33-56	Nicholas with fixed transformer
31-33-36	Fluorescent
31-33-24-01	Reflector
31-34-83	Vertical

Model SVB-73. 0.7X thru 3X-31-26-40-73
Model SVB-12. 1X thru 2X-31-26-40-12



See pages 24-26 for complete descriptions of illuminators.

THE SERIES

SK

STEREOZOOM MICROSCOPE

For examination of opaque objects in any plane

Bausch & Lomb StereoZoom Microscope, Balcoted; sealed Power Pod rotatable thru 360°, inclined eyepieces, reversible, synchronized interpupillary distance adjustment, acuity equalizer; continuous positive focus by extra wide matched rack and pinion on counter-balanced, rotatable horizontal arm with rack and pinion radial adjustment, with five joints permitting three pivoting and four rotating movements for universal adjustment in any plane; heavy cast iron base with vertical adjustment by ball bearing nut mechanism actuated by handle and brake; constant 4" working distance; 3 locations for integral illumination; 10× paired wide field eyepieces with eyeguards; plastic dust cover; reference and maintenance manual; corrugated carton; specific models as listed below:



Stand—31-26-97 with
Rotatable Arm—31-26-90*



1× Fixed Power Pod—31-26-91
2× Fixed Power Pod—31-26-92



0.7× thru 3× StereoZoom Power Pod—31-26-94
1× thru 2× StereoZoom Power Pod—31-26-93

OPTICAL SPECIFICATIONS

Total magnifications as shown can be changed by using other eyepieces or lens attachments. See pages 26-27.

Cat. No.	Model	Description
31-26-41-01	Model SKFB-1	1× Fixed Power Pod (total magnification 10×)
31-26-41-02	Model SKFB-2	2× Fixed Power Pod (total magnification 20×)
31-26-41-12	Model SKVB-12	1× thru 2× StereoZoom Variable Power Pod (total magnification 10× thru 20×)
31-26-41-73	Model SKVB-73	0.7× thru 3× StereoZoom Variable Power Pod (total magnification 7× thru 30×)

*31-26-59 Stationary Army in place of 31-26-90 Rotatable Arm available at correspondingly lower cost.



Model SKFB-1. 1X-31-26-41-01
Model SKFB-2. 2X-31-26-41-02

ILLUMINATORS—Harmonizing Design

Cat. No.	Description
31-33-53	Nicholas with adjustable transformer
31-33-56	Nicholas with fixed transformer
31-33-36	Fluorescent
31-33-24-01	Reflector
31-34-83	Vertical

Model SKVB-73. 0.7X thru 3X-31-26-41-73
Model SKVB-12. 1X thru 2X-31-26-41-12

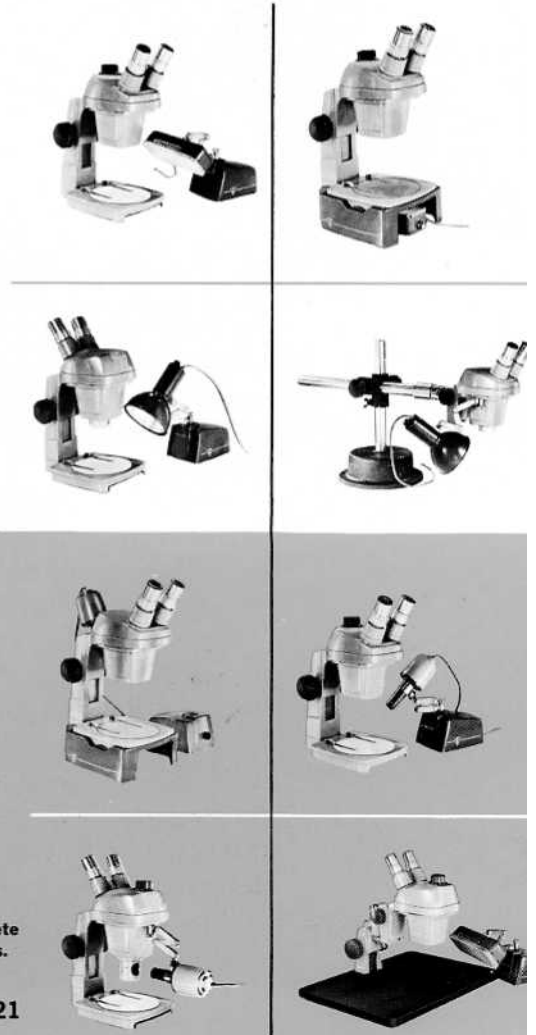
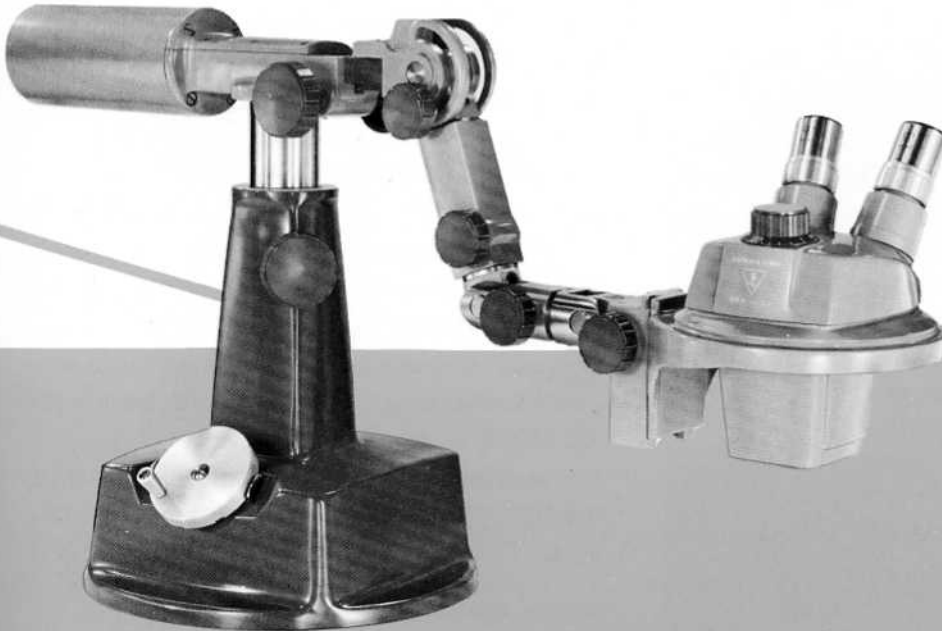

See pages 24-26 for complete descriptions of illuminators.

Depth Measuring Stereomicroscope

For opaque objects



Easier, Speedier Depth Measurements

This new Depth Measuring Stereomicroscope provides a fast, accurate method of making depth measurements, with the advantage of requiring no actual physical contact with the material being measured. Making use of the observer's sense of depth perception, it provides an answer to many depth-measuring problems that perhaps would be impossible to solve with other measuring instruments.

Since this instrument measures without actual physical contact, it is especially useful in depth measuring applications with materials that are too soft or resilient to provide an accurate reference point when even the lightest spindle pressure is applied. A repeatability of $\pm 0.0004''$ can be achieved with the B&L Depth Measuring Stereomicroscope.

How it Works

The instrument is a specially designed Stereomicroscope supplied with a 2 \times Power Pod, special 10 \times Wide Field eyepieces with target scales to assure focus at a definite plane in space and a dial micrometer gage. Total magnification is 20 \times . The dial micrometer is mounted on the microscope arm, with the spindle bearing on the focusing slide. The dial records minute changes in the slide's travel over a total range of 1". Least reading is to .001".

In use, the observer focuses sharply, twice, on the detail being measured for depth — first on one surface, then on the other. The dial records the linear travel of the focusing slide in going from one focus to the other. The difference between these two readings is your depth measurement.

SPECIFICATIONS

Bausch & Lomb Depth Measuring Stereomicroscope, Balcoted, sealed Power Pod with inclined eyepieces; synchronized interpupillary distance adjustment, acuity equalizer; continuous positive focus by extra wide matched rack and pinion; constant 4" working distance; 3 locations for integral illumination; large stage with clips and reversible black and white contrast plate; 10 \times paired wide field eyepieces with dot reticles; right eyepiece reticle centering adjustment; depth measuring gage, 1" range with least reading of 0.001"; engraved alignment slide 1" x 3"; plastic dust cover; reference and maintenance manual; corrugated carton; one model as follows:

MODEL ADM-2

31-26-44-02 Depth Measuring Stereomicroscope, 2 \times Fixed Power Pod, (total magnification 20 \times).

StereoZoom Training Microscope

As the name implies, this arrangement, through its ability to provide viewing of a single object by two people, fills a long felt need for a simple yet efficient means for employee training in the use of the 3D microscope. What is not demonstrated in the name is the feature-fact that the components are regular items in the Bausch & Lomb StereoZoom line. When not being used together for dual viewing they fulfill their pur-

pose for individual use.

The long working distance permits the instructor to point out detail in the object being examined and, if necessary, to manipulate the specimen for most thorough instruction of the trainee. Just the right magnification is achieved by the use of the Zoom knob and the clear, bright three-dimensional image requires no translation by either viewer.

Specifications

Catalog No.	Description
StereoZoom Training Microscope set-up for OPAQUE OBJECTS ONLY (Fixed power, 5 \times), consisting of:	
1 No. 31-26-39-02	Model KFB-2 StereoZoom Microscope
1 No. 31-26-29-01	Model AFB-1 StereoZoom Microscope
1 No. 31-26-18	0.5 \times Lens Attachment
1 No. 31-34-83	Vertical Illuminator

For both Transparent and Opaque objects substitute Model BFB-1, No. 31-26-30-01, for the Model AFB-1. See price list for additional cost.

StereoZoom Training Microscope set-up for OPAQUE OBJECTS ONLY (Variable Power, 10 \times through 20 \times), consisting of:	
1 No. 31-26-39-12	Model KVB-12 StereoZoom Microscope
1 No. 31-26-29-12	Model AVB-12 StereoZoom Microscope
1 No. 31-26-18	0.5 \times Lens Attachment
1 No. 31-34-83	Vertical Illuminator

For both Transparent and Opaque objects substitute Model BVB-12, No. 31-26-30-12, for the Model AVB-12. See price list for additional cost.

StereoZoom Training Microscope set-up for OPAQUE OBJECTS ONLY (Variable Power, 7 \times through 30 \times), consisting of:	
1 No. 31-26-39-73	Model KVB-73 StereoZoom Microscope
1 No. 31-26-29-73	Model AVB-73 StereoZoom Microscope
1 No. 31-36-18	0.5 \times Lens Attachment
1 No. 31-34-83	Vertical Illuminator

For both Transparent and Opaque objects substitute Model BVB-73, No. 31-26-30-73, for the Model AVB-73. See price list for additional cost.

StereoZoom Training Microscope set-up with No. 31-26-30-73 Model BVB-73, with No. 31-26-18 Supplementary Lens Attachment (left); No. 31-26-39-73, Model KVB-73, with No. 31-34-83 Vertical Illuminator (right); No. 31-33-53 Nicholas Illuminator (attached to Model BVB-73).



Newly Designed Illuminators

give just the right amount
and type of light for
best viewing.

Next to optical quality, the sharpness and clarity of an image seen through the microscope depend on the abundance and type of lighting used. And what may be exactly the right lighting for one application will not necessarily be efficient in another. The complexity and particular makeup of the material to be viewed, and the fineness of detail one wishes to observe should be determining factors in selecting a microscope illuminator. For these reasons, B&L offers a complete line of illuminators to meet all demands.

The B&L illuminators pictured and described on these pages were developed especially for use with this newest line of stereomicroscopes. These light sources may be used integrally attached to the microscope or separately mounted on their own bases. They will insure your getting the *right* kind of illumination *where* you need it, so that you can take full advantage of the optical and mechanical precision built into B&L Stereomicroscopes.

All four types of Power Pods come equipped with 3 illuminator stations for integral illumination. In addition, models in the A series have a port at the top of the Power Pod support for insertion of the Nicholas Illuminator. Models in the B series have two ports for attachment of the Nicholas Illuminator—one at the top of the Power Pod support and another in the rear of the microscope base. The Stationary Arm, 31-26-59, optional on Series SK, and standard equipment on Series KT, K, and S also has the port for insertion of the Nicholas. The under-stage mirror of the B series is instantly removed and replaced by the Fluorescent Illuminator to provide a built-in light source.



Fluorescent
Illuminator—
31-33-36



Reflector
Illuminator—
31-33-24-01



Nicholas
Illuminator.
Variable Intensity
model as shown—
31-33-53.
Fixed Intensity
model—31-33-56

Nicholas Illuminator

Newly designed to provide much cooler operation, this illuminator is recommended for examination of both surface and internal details under all magnifications — low, medium and high. It is indispensable for lighting small or deep apertures such as cracks, crevices, holes, etc., particularly when used in conjunction with the Vertical Illuminator.

A highly corrected condenser concentrates brilliant intense light on a small area to assure that no detail will be overlooked no matter how complex the material being examined.

Two models of this illuminator can be supplied—one having an adjustable transformer base to give a choice of light intensity, the other with a fixed voltage transformer base for those applications which do not require varied intensities of light.

Illuminator and three-link adjustable arm may be quickly removed from the transformer base for attachment directly in the illuminator stations provided in the Power Pod. In addition, the arm is also easily removable when it is desirable to use this illuminator in the port of arms so designed.

Fluorescent Illuminator

Two 4 watt daylight tubes in this illuminator flood the object or specimen with cool, diffused light. It is suited for observation of surface details at low magnification and as a substage illuminator with B series models for transmitted light applications at low and high power. In the latter application, it replaces the mirror and automatically locks in a centered position.

When attached to any one of the 3 illuminator stations found in all Power Pods, it auto-

matically provides ideal illumination without adjustment, no matter how thickness varies in the material viewed. A plastic opalescent diffuser snaps over the fluorescent tubes to assure greater diffusion and to eliminate bright bars of light.

The illuminator is supported by an arm fashioned of three sets of double links with friction-spring pressure control so that it will stay in position despite vibration or jarring.

Heavy cast base provides ample support when used as a separate light source. Removal of arm and lamp for attachment to the microscope requires only a few seconds—and no tools.

Reflector Illuminator

Providing a large area of light for the larger fields of view obtained with low and medium power magnifications, this illuminator is recommended for examination of both surface and internal details. It supplies diffuse light of greater intensity than the Fluorescent Illuminator. The Reflector Illuminator has the same sturdy base and three link arm as the Fluorescent. It is recommended for use with the Vertical Illuminator when examining highly reflective surfaces.

Easily removed from its base without tools, it can be attached to any one of the illuminator stations provided in the microscope.

Vertical Illuminator

Used with the Nicholas or Reflector Illuminator, this illuminator is particularly useful for examining interior surfaces of castings or machined parts, cracks, holes, crevices, etc. For the examination of heavy textiles, paper, semi-translucent plastic, etc., adjustment of the mir-

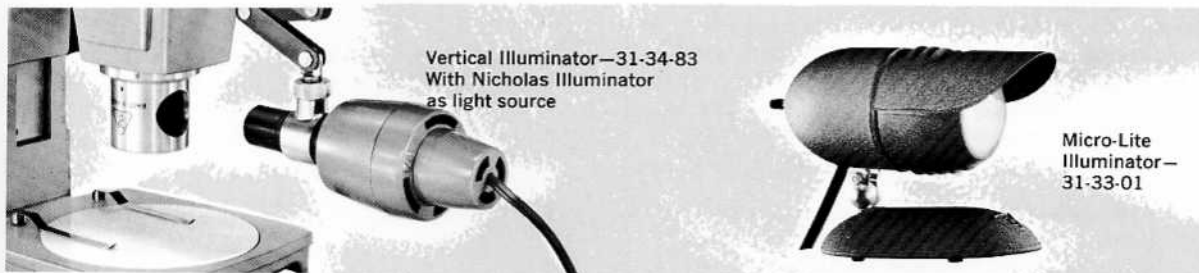

Vertical Illuminator—31-34-83
With Nicholas Illuminator
as light source

Micro-Lite
Illuminator—
31-33-01

ror in the base of the Model B series stereomicroscopes, will provide a combination of vertical and transmitted illumination. Where added intensity of transmitted illumination is necessary, the Fluorescent Illuminator may be substituted for the mirror.

The Vertical Illuminator Mount threads into the underside of the Power Pod and the 0.5× Supplementary Lens Attachment. The reflector aperture can be turned 360° to permit precise alignment with the light supplied. A locking collar keeps it accurately positioned.

Micro-Lite Illuminator

This low-cost illuminator is suitable for simple routine applications particularly on models in the B series. It is compact and light-weight. Pressure controlled ball and socket joint permits directing the light in any direction. Light source is a household type 60 watt lamp. Bull's-eye type condensing lens with one surface ground provides evenly diffused illumination. Blue filter behind the condenser produces light approximating daylight quality.

Specifications

ILLUMINATORS

- 31-33-53 Nicholas Illuminator with 6.5-v., 2.75-amp. pre-focus lamp, lamp housing, fixed focus condenser in friction ring clamp on adjustable link arm removable from base by knurled screw; adjustable intensity transformer base; for 115-v., 60 cycle A.C.
- 31-33-56 Nicholas Illuminator, same as No. 31-33-53 except with fixed intensity transformer base.
- 31-33-36 Fluorescent Illuminator with two 4 watt daylight tubes, opalescent diffusor and switch; adjustable link arm detachable from illuminator housing or base by knurled screws; with base; for 115-v., 60 cycle A.C.
- 31-33-24-01 Reflector Illuminator with 30-w., 120-v. lamp, reflector, and adjustable link arm detachable from base by knurled screw; with base; for 115-v.
- 31-34-83 Vertical Illuminator with reflector and locking device for orientation; in threaded mount to attach to stereomicroscope Power Pod; without light source.
- 31-33-01 Micro-Lite with 60-w., 120-v. lamp, condenser and blue filter; ball and socket joint for inclination adjustment; with base; for 115-v., 60 cycle A.C.

How to Determine the Best Optical Combination for Your Application

Your choice of optical combination — Eyepieces, Power Pod and perhaps Lens Attachment — will be governed by several factors, including the field size you need, the range of magnification and routine application to which you will apply your stereomicroscope. Field size (the area that you wish to view) is a function of magnification. The lower the magnification, the larger the field size and vice-versa. Choice of magnification depends on the size of the material you will be viewing. In general, you will need higher magnification for very small objects and lower power for larger objects. If you encounter a variety of object sizes in your everyday use, the StereoZoom variable

Power Pod, Fixed, and StereoZoom Continuously Variable Magnification, with and without Lens Attachments

1× Fixed Magnification Power Pod	Total Mag. Field Size	
2× Fixed Magnification Power Pod	Total Mag. Field Size	
0.7×-3× StereoZoom Power Pod	Total Mag. Field Size	
1×-2× StereoZoom Power Pod	Total Mag. Field Size	
	Working Distance	

power models will give you the greatest versatility. Where your microscope will be routinely used on the same size and type of material, generally at the same magnification, a fixed power model will probably be your choice.

If your choice of Stereomicroscope is a StereoZoom model because you need a variety of powers, selection of the proper magnification is a simple matter. Knowing in which broad range of magnification you will work, you need only select a combination of eyepieces, Power Pod and lens attachment that will put you in the desired range. You choose your *exact* magnification by turning the StereoZoom dial and watching the image grow or reduce to the size you need. If you prefer a fixed power model, you will want to weigh magnification against field size, as shown in the chart below, and select eyepieces and lens attachments that best meet your requirements.

Normally another important consideration is working distance, the space between the lower lenses of the Power Pod and the material being viewed. However, with these new B&L Stereomicroscopes, working distance is a con-

stant 4 inches at all magnifications when lens attachments are not used. It is only necessary to remember that the 2× attachment changes working distance to 1½ inches; the 0.5× attachment increases it to 7 inches. The 0.5× attachment lens, because of the increased working distance, is made for use on models in the K, KT, S and SK series where this additional vertical height can be achieved. Of course, your immediate choice of a particular magnification—whether Fixed Power Pod 1× or 2×, or StereoZoom Variable Power Pod 1× thru 2× or 0.7× thru 3×—does not limit your Stereomicroscope for some future application where other magnifications may be needed. The exclusive self-contained, interchangeable design of the Power Pod always allows you, at some future date, to purchase an additional Pod of different power. You don't have to buy a complete new microscope stand, just a new range of magnification. Changing to another power of wide field eyepiece or adding the 0.5× or 2× lens attachment will still further increase the variety of magnifications you can achieve with your B&L Stereomicroscope.

MAGNIFYING POWERS AND FIELD SIZES

In those columns headed "With . . . Lens Attachment" two sets of figures are given— one set indicates magnification, field size, and working distance with the lens attachment on the microscope—the other, with the lens attachment removed.

WITH 10× WIDE FIELD EYEPIECES

WITH 15× WIDE FIELD EYEPIECES

WITH 20× WIDE FIELD EYEPIECES

Without Lens Attach.	With 0.5× Lens Attach.	With 2× Lens Attach.	Without Lens Attach.	With 0.5× Lens Attach.	With 2× Lens Attach.	Without Lens Attach.	With 0.5× Lens Attach.	With 2× Lens Attach.
10× .787"	5× and 10× 1.574" and .787"	10× and 20× .787" and .394"	15× .681"	7.5× and 15× 1.362" and .681"	15× and 30× .681" and .341"	20× .480"	10× and 20× .960" and .480"	20× and 40× .480" and .240"
20× .394"	10× and 20× .787" and .394"	20× and 40× .394" and .197"	30× .341"	15× and 30× .681" and .341"	30× and 60× .341" and .171"	40× .240"	20× and 40× .480" and .240"	40× and 80× .240" and .120"
7× thru 30× 1.124" thru .262"	3.5× thru 30× 2.248" thru .262"	7× thru 60× 1.124" thru .131"	10.5× thru 45× .973" thru .227"	5.25× thru 45× 1.946" thru .227"	10.5× thru 90× .973" thru .114"	14× thru 60× .686" thru .160"	7× thru 60× 1.372" thru .160"	14× thru 120× .686" thru .080"
10× thru 20× .787" thru .394"	5× thru 20× 1.574" thru .394"	10× thru 40× .787" thru .197"	15× thru 30× .681" thru .341"	7.5× thru 30× 1.362" thru .341"	15× thru 60× .681" thru .171"	20× thru 40× .480" thru .240"	10× thru 40× .960" thru .240"	20× thru 80× .480" thru .120"
4"	7" (a) 4"	4" 1½"	4"	7" (a) 4"	4" 1½"	4"	7" (a) 4"	4" 1½"

(a) Used on Series K, KT, S and SK Models

Accessories and Interchangeable Parts

Interchangeable Power Pods

The user of a new B&L Stereomicroscope is prepared to easily satisfy changed requirements in magnification ranges. He need only purchase the new Power Pod that provides the magnification or magnifications required. All Power Pods can be purchased separately.

Long Eye-Relief Wide Field Eyepieces

These completely new eyepieces provide a comfortable eye-relief. The 10 \times , which have especially long eye-relief, are ideally suited for the eyeglass wearer, allowing him to concentrate on his work or examination without the annoyance of having his glasses brush against the lens of the eyepieces. They are fully corrected for color and distortion, assure sharpest focus and flat, wide usable fields. Anti-reflection Balcote increases their light transmission to the highest possible level. B&L Wide Field Eyepieces can be supplied in 10 \times , 15 \times , or 20 \times magnifications. All quickly accept standard or special micrometer discs for precise measuring work.

Eyeguards

Eyeguards are standard equipment on all models. Their primary function is to prevent strong

stray light from reflecting on the eyepieces and causing bothersome glare. They also serve to quickly position the eyes at the correct distance from the eyepieces. Eyeguards are not designed for use with eyeglasses.

Supplementary Lens Attachments

It is often convenient to quickly extend the range of magnification for certain applications. This is easily accomplished by the use of a Lens Attachment that simply screws to the bottom of the Power Pod. Two types are available—0.5 \times which reduces magnification by one-half and changes working distance from 4 inches to 7 inches—and 2 \times , which doubles magnification and changes working distance to 1 $\frac{1}{2}$ inches. The 0.5 \times Lens Attachment is for use on models in the K, KT, S, and SK series where additional vertical focus is available. It is threaded to take the Vertical Illuminator.

Clear Glass Shield

This provides added insurance against damage to optical elements from flying metal chips, oil or chemical splashes, etc. The shield screws to the bottom of the Power Pod — cannot be used when either of the Lens Attachments is in

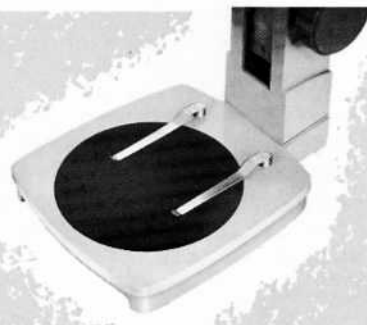

Opaque Contrast Plate—
31-26-87



Clear Glass Stage Plate—
31-26-86



Trans-Illumination Base—
(supplied with clear glass plate)
31-26-84-86

place on the microscope, but these provide the same protection. Fixed Power Pods are regularly supplied with this shield.

Trans-Illumination Base

This base is available as an accessory to convert Series A models for transmitted illumination work. It is the same base supplied on the Series B models. It has a concave mirror with a diffusing reflector on the reverse side, and clear glass stage plate. Mirror controls in the sides permit positioning the mirror for optimum illumination. To provide the advantages of integral illumination, a port at the rear of the base will accept the B&L Nicholas Illuminator. The Fluorescent Illuminator may be inserted in the Trans-Illumination Base by removing the mirror.

Arms

Illustrations below show two Arms interchangeable on Series K, KT, S and SK.

The 31-26-59 Arm is supplied on Series K, KT, and S. In this arm the Power Pod can face either to the front or rear. Three stations are provided for attaching illuminators to the Power Pod and it has a port for the Nicholas Illuminator.

Standard Arm for the SK series is 31-26-90. With it the Power Pod can be rotated through 360° to allow observations from any position. Illuminators can be attached to any of the three holes in the Power Pod. A nominal extra charge is made when this arm is substituted on K, KT, or S series StereoZoom Microscopes.

Stage Plates

The heavy Clear Glass Stage Plate is free of bubbles or striations that could interfere with image quality. All Stereomicroscopes in the Series B models are regularly supplied with this plate.

The Opaque Contrast Plate provides high contrast for work with opaque materials. It is black on one side, white on the other. Material is a rigid metal that is highly resistant to scratches and chemical stains.

Storage and Carrying Case

Extremely handsome in appearance, this horizontal case is covered in two-tone gray leatherette. It has brackets for the stage plate and a pair of eyepieces, and comes equipped with handle, lock and key. For use with Series A and Series B models only.



Stationary Arm with Port
31-26-59



Rotatable Arm
31-26-90



Clear Glass Shield—
31-26-21

Supplementary Lens Attachments—
0.5X—31-26-18
2.0X—31-26-19



Eyeguards
regularly supplied with Wide Field Eyepieces—
10×—31-50-68
15× and 20×—31-50-64



Wide Field Eyepieces—
10×—31-05-61-02
15×—31-05-62-02
20×—31-05-63-02

Specifications

INTERCHANGEABLE POWER PODS, WITH INCLINED EYEPIECE HOLDERS

- 31-26-91** 1× Fixed Power Pod.
31-26-92 2× Fixed Power Pod.
31-26-93 1× thru 2× StereoZoom continuously variable Power Pod, dial graduated in 0.1× divisions.
31-26-94 0.7× thru 3× StereoZoom continuously variable Power Pod, dial graduated in 0.1× divisions.

LONG EYE-RELIEF EYEPIECES, PAIRED, BALCOTED

- 31-05-61-02** 10×, 0.870" (22.1mm) eye-relief, with eyeguards.
31-05-62-02 15×, 0.440" (11.2mm) eye-relief, with eyeguards.
31-05-63-02 20×, 0.401" (10.2mm) eye-relief, with eyeguards.

EYEGUARDS, PAIRED

- 31-50-68** For 10× Wide Field Eyepieces
31-50-64 For 15× and 20× Wide Field Eyepieces

SUPPLEMENTARY LENS ATTACHMENTS

- 31-26-18** 0.5×, for Series K, KT, S, and SK (changes Work. Dist. from 4" to 7").
31-26-19 2×, for all series (changes working distance from 4" to 1½").
31-26-21 Clear Glass Shield. Standard on fixed Power Pods. Protects lower lenses of Power Pod against corrosive and wet materials or flying particles.

TRANS-ILLUMINATION BASE

- 31-26-84-86** Attachable Base for transmitted illumination of transparent or translucent objects on Series A; (standard on Series B) with illuminator port, concave mirror, flat diffusing reflector, mirror controls, optional clear glass plate.

STANDS

- 31-26-88** Stand, with arm, as supplied on Series A and B.
31-26-95 Stand only, without arm, as supplied on Series K.
31-26-96 Stand, with collar clamp, without arm, as supplied on Series S.
31-26-97 Stand, without arm, as supplied on Series SK.
31-26-65 Stand, without arm, with lower rack and pinion, with fibre composition baseboard, 12" x 16", for Series KT.

INTERCHANGEABLE ARMS

- 31-26-90** Rotatable Arm, for continuous 360° rotation of Power Pod. Standard on SK series, and interchangeable with stationary arm on K, KT, and S series.
31-26-59 Stationary Arm, for 180° reversal of Power Pod, upper rack and pinion and swivel joint; port for Nicholas Illuminator. Standard on Series KT, K, and S, interchangeable on Series SK.

STAGE PLATES

- 31-26-86** Clear Glass Stage Plate, for use on Series A and B models.
31-26-87 Opaque Contrast Plate, black on one side, white on reverse, for Series A and B.

STORAGE AND CARRYING CASE

- 31-40-11** Horizontal storage and carrying case, two tone gray leatherette, with brackets for stage plate and pair of eyepieces; with handle, lock and key for Series B models.
31-40-11-12 Storage Case, same as 31-40-11 above, except for Series A models.

Linear Measuring with the StereoZoom Microscope



MEASURE — Length, Diameters, Angles
CHECK — Contours, Parallelism
USE — As an efficient "Go—No-Go" Gage

There is a special B&L Depth Measurement Stereomicroscope for depth measurements but *any* B&L Stereomicroscope can be used for accurate linear measurements with B&L Micrometer Discs (scales or patterns). These are simply inserted in one of the Wide Field Eyepieces and appear superimposed on the object or part.

The most common micrometer eyepiece discs or scales for measurement are listed on this page. For others, write for Catalog D-184 which illustrates and describes the complete line of standard discs.

Special micrometer discs (scales or patterns) can be supplied for those applications not covered by one of the standard discs. Simply submit a print or sketch giving exact measurements, with tolerances, of the object or specimen seen in the field of view. Also indicate the desired magnification, if known. Our engineers will design a disc (scale or pattern) that will make *your* operation more efficient.

New Precalibrated Eyepiece Discs

Three new eyepiece discs were designed especially for use with this new line of B&L Stereomicroscopes. The 31-16-08 Disc is precalibrated to provide 0.001" values for each least interval on the scale at 3× Power Pod magnification; the 31-16-04 Disc measures 0.002" values at 2× Power Pod magnification; the 31-16-07 measures 0.005" values at 1× Power Pod magnification. To measure 0.001" comfortably, a total magnification of 30×-40× is recommended. For routine measuring, it is not necessary to calibrate these discs with a stage micrometer.

Where extreme accuracy is required, it is recommended that the discs be precisely cali-



Micrometer disc being used to measure extent of fracture in metal specimen



31-16-90 Stage Micrometer for precise calibration of eyepiece discs, 2.2 long, ruled to 0.1mm with 0.2mm ruled to 0.01mm



These are just 2 samples of scales we have made to order

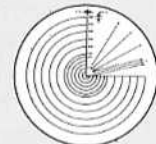

brated with one of the 3 stage micrometers listed below.

After the disc is inserted in the eyepiece it must be calibrated (except as noted in the paragraph under "New Precalibrated Eyepiece Discs") with Stage Micrometer 31-16-87, 31-16-89, or 31-16-90 to determine the exact value of its scale. Calibration instructions are given in the Reference Manual supplied with each Stereomicroscope. If desired, calibration can be done at the factory at slight extra cost.

Specifications

Eyepiece Discs, Stage micrometers

- 31-16-08** Disc, each least division value of 0.001" at 3× Power Pod magnification.
- 31-16-04** Disc, each least division value of 0.002" at 2× Power Pod magnification.
- 31-16-07** Disc, each least division value of 0.005" at 1× Power Pod magnification.
- 31-16-02** Disc, 10mm, ruled to 0.1mm.
- 31-16-05** Disc, 5mm, ruled to 0.1mm.
- 31-16-30** Cross Line Disc, 21mm dia.
- 31-16-87** Glass Stage Micrometer, ruled to 0.005" divisions.
- 31-16-89** Glass Stage Micrometer, ruled to 0.01" and 0.001" divisions.
- 31-16-90** Glass Stage Micrometer, ruled to 0.1mm and 0.01mm.

BAUSCH & LOMB

StereoZoom

Microscopes



Bausch & Lomb Incorporated

Rochester 2, N.Y., U.S.A.