

Black & Decker

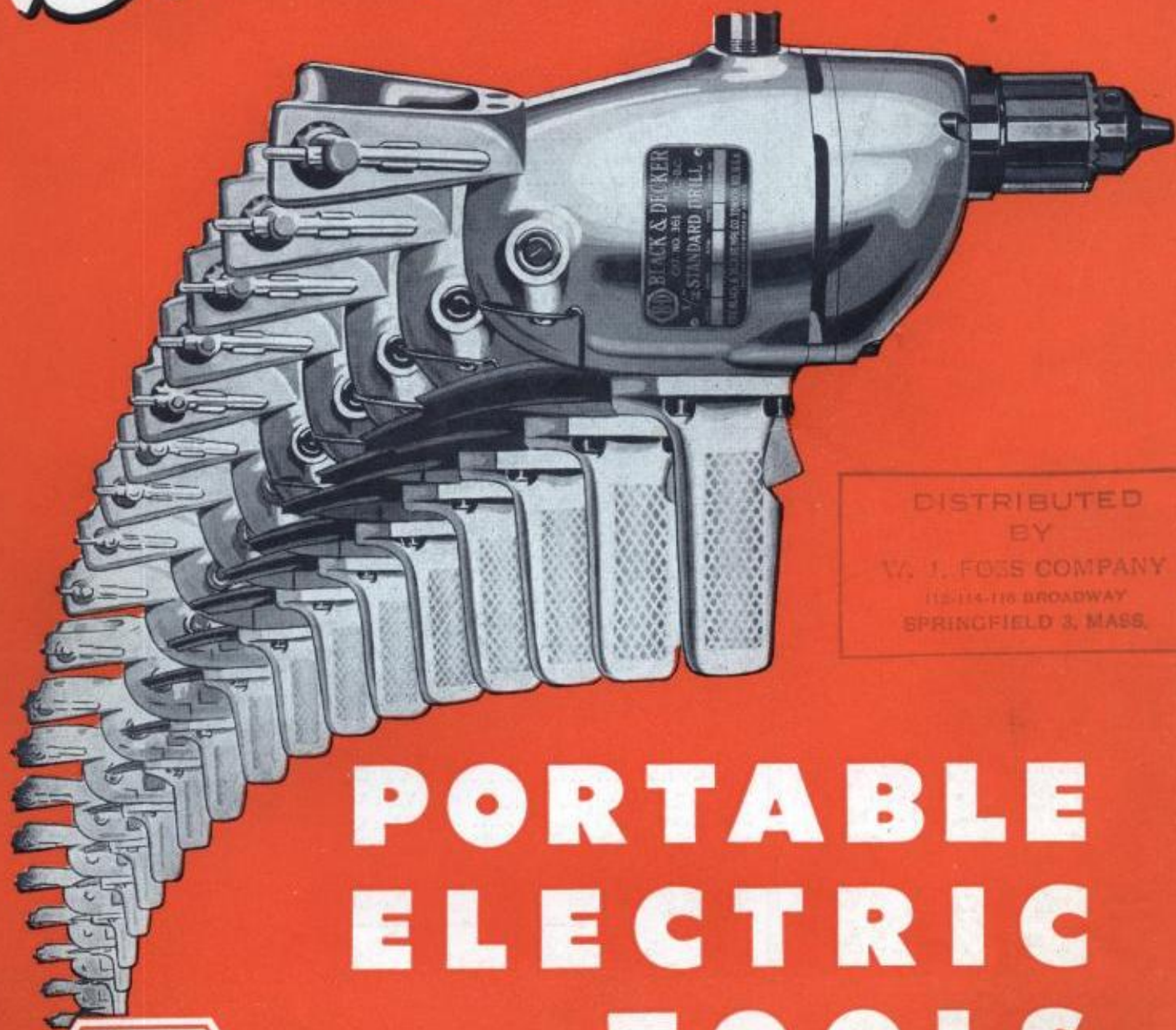

DISTRIBUTED
BY
W. J. FOSS COMPANY
112-114-116 BROADWAY
SPRINGFIELD 3, MASS.

PORTABLE ELECTRIC TOOLS



1 9 5 3



Black & Decker

ELECTRIC
TOOL
HEADQUARTERS

INDEX

ELECTRIC TOOLS ONLY

Drills	2-9
Glue Pot	22
Grinders	30-34
DIE - PORTABLE - BENCH	
Hammers	37-38
Polishers	23
Porto-Shears	42
Sanders	25-26
Screw Drivers	15-18
Tapgun	14
Vackar	43
Valve Shop	44-45
Valve Refacer	46-47
No. 6 Valve and Tool Grinder	50-51
Valve Seat Grinding Equipment	52-60

The Complete Line of Portable Electric TOOLS, ATTACHMENTS and SUPPLIES

Abrasive Discs	30	Pilots, Valve Seat Grinding	57
Balance Reel	22	Planer Heads	29
Bench Drill Stands	10	Polishers, Portable	23
Bench Grinders	32-34	Portable Grinders	30-31
Bits, Screw Drivers	19-21	PORTO SHEARS	42
Brushes, Wire	29, 36, 60	Radial Arm	9
Buffers, Portable	24	Reel, Balance	22
Buffing Supplies	27-29, 35	Refacers, Valve	44-51
Buffing Wheels	35	Refacer Attachments	48-49
Carbon Cleaning Tools	60	Right-angle Drill Attachment	13
Chucks, Drill (Replacement)	12	Right-angle Heads	20
Cleaner, Vacuum	43	Sanders, Portable	25
Coal Drills	9	Sander Attachments	27-29
Die Grinders	30	Saws, Hole	11
Dressers, Wheel	35	Screw Driver Bits	19-20
Dressing Stands, Valve Seat	56	Screw Drivers, Portable	15-18
DRILLS, Portable	2-9	SCRUGUNS	15-16
Drill Attachments	10-13	Shears, Portable	42
Drill Stands	9-10	Socket Wrenches	21
Feather Edging Attachment	26	Stones, Vibro-Centric	58-59
Feed Screws, for Drills	13	TAPGUN	14
Glue Pot	22	Tappers, Portable	14
Grease for Tool Gears	22	VACKAR	43
Grinders, Bench	32-34	Vacuum Cleaner	43
Grinders, Die	30	Valve Guide Cleaners	60
Grinders, Portable	31	Valve Refacers	44-51
Grinder, Valve & Tool, No. 6	50-51	Valve & Tool Grinder, No. 6	50-51
Grinder, Valve	44-51	Valve Seat Grinders	52-60
Grinding Wheels	29, 35	Valve Shop	44-45
Hammers, Portable	37-38	VIBRO-CENTRIC Grinders	52-54
Hammer Tools	39-41	Vibro-Centric Kits	53-55
Heaters, Glue	22	Vibro-Centric Supplies	56-60
Hole Saws	11	WHIRLWIND Brushes	29, 36, 60
HOLGUNS	3	Wire Wheel Brushes	36
Kits, Vibro-Centric	53-55	Wire Cup Brushes	29
Lubricants	22	Wrenches, Socket	21
Pedestals, for Grinders	33		
FACTORY SERVICE BRANCHES		Page 61	

ALL PRICES SHOWN IN THIS CATALOG ARE NET PRICES TO THE USER. PRICES ARE SUBJECT TO CHANGE WITHOUT NOTICE.

"BUY from your BLACK & DECKER Distributor"

For greater convenience and quicker service to users, Black & Decker Portable Electric Tools, Attachments and Supplies are sold through and carried in stock by leading automotive, hardware, electrical, industrial, plumbing, machinery and mill supply distributors throughout the world. Depend on your local distributor for expert help and advice on all tooling problems and as a convenient source for all equipment and supply needs.

LEADING DISTRIBUTORS EVERYWHERE SELL BLACK & DECKER





Black & Decker

ELECTRIC
TOOL
HEADQUARTERS

Motors and VOLTAGE SPECIFICATIONS

**1/4-INCH
HEAVY-DUTY
HOLGUN DRILL**



**1/4-INCH
HEAVY-DUTY
DRILL**



**3/8-INCH
HEAVY-DUTY
DRILL**



THE MOTOR is the "heart" of any electric tool. It must produce ample power to supply the necessary amount of torque, or turning effort, at the most efficient spindle speed. It must be held to definite weight and size limits, so that the tool it drives is not too bulky or heavy for production service.

All motors in Black & Decker Electric Tools (except Bench Grinders and No. 6 Universal Valve and Tool Grinders) are "universal" motors; i.e., they will operate on either direct current or single-phase alternating current of 25 to 60 cycles of the specified voltage. By designing and building our own motors, we can control the specifications to exact limits and you can depend on a reliable source of power that is neither too strong nor too weak; neither too large nor too small; neither too fast nor too slow for the job you want that tool to do. Note the three motors pictured above. The 1/4" Heavy-Duty HOLGUN has compactness as one of its prime features—so its motor is small and long. The 1/4" Heavy-Duty Drill does still heavier work, but compactness is not quite so vital; so the motor diameter is increased. The 3/8" Heavy-Duty Drill, because of its increased capacity, requires a longer motor of the same diameter. **Every Black & Decker Tool is powered by a Black & Decker motor designed and built for the specific tool it is intended to drive!**

VOLTAGE SPECIFICATIONS—It is important that you specify the voltage desired in every Black & Decker tool when you place your order. If voltage is not specified in your order, tools will be furnished with motors for operation on 115 volt current. We can also furnish tools with 220 volt motors from stock and with 125 volt or 240 volt motors on special order. A few tools are also available with 32 volt motors, from stock where indicated in individual specifications. Motors supplied for nominal voltages as shown will operate on voltage ranges as indicated in the following table.

32 Volt—No range		
115 Volt—Range 110 to 120 V	125 Volt—Range 120 to 130 V	
220 Volt—Range 210 to 230 V	240 Volt—Range 235 to 250 V	

When ordering Bench Grinders or No. 6 Universal Valve and Tool Grinders, it is necessary that we know the phase and cycle as well as the voltage of your current supply. Available current specifications are itemized in the listings for these tools and unless current specifications are given in your order, they will be furnished for 115 volt, single phase, 50-60 cycle current.



Black & Decker

ELECTRIC
TOOL
HEADQUARTERS

Black & Decker Drills are first in quality and performance the world over! Here are some of the important features that have given them this leadership—

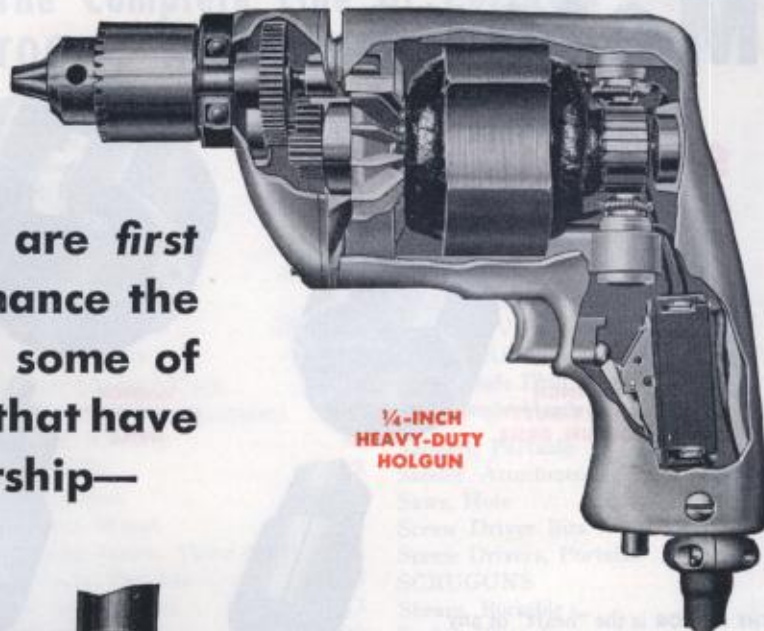

**1/4-INCH
HEAVY-DUTY
HOLGUN**

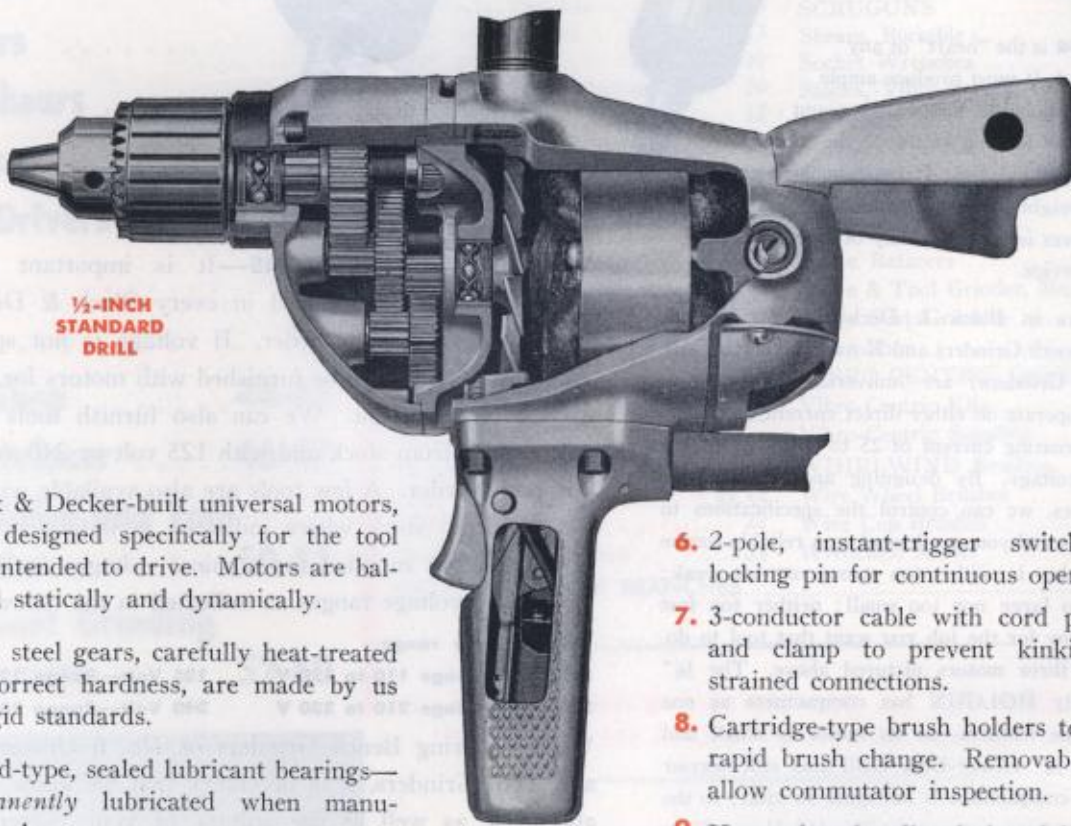

**1/2-INCH
STANDARD
DRILL**

1. Black & Decker-built universal motors, each designed specifically for the tool it is intended to drive. Motors are balanced statically and dynamically.
2. Alloy steel gears, carefully heat-treated for correct hardness, are made by us to rigid standards.
3. Closed-type, sealed lubricant bearings—permanently lubricated when manufactured.
4. Housings are cast of high grade aluminum—accurately machined for interchangeability.
5. Efficient fans and ample ventilating ports prevent clogging and maintain low operating temperatures.
6. 2-pole, instant-trigger switch, with locking pin for continuous operation.
7. 3-conductor cable with cord protector and clamp to prevent kinking and strained connections.
8. Cartridge-type brush holders to permit rapid brush change. Removable plates allow commutator inspection.
9. Heavy-duty handles designed for maximum tool control. Auxiliary spade and pipe handles furnished on heavier drills.
10. Engineered weight distribution for best operating balance, and the overall "Know-how" in building electric tools that comes from over 40 years' experience in the electric tool industry.



Black & Decker

ELECTRIC
TOOL
HEADQUARTERS

1/4" SHORTY* Ball-Bearing Drill

ABILITY to work "around corners" has popularized this drill in many small-unit production and assembly operations. Overall working (spindle) length is only 4 1/2". Small, round motor housing requires no extra handle. Ideal for aircraft, trim work, cabinet assembly and as a "kit" tool.

Specifications

Capacity: in Steel	up to 3/8"
in Hardwood	up to 1/2"
Speed: No-load (Standard)	2500 R.P.M.*
Full-load	1600 R.P.M.
*Optional No-load Speeds (at no extra cost)	13700 R.P.M.
Weight: Net	3 3/8 lbs.
Shipping	5 lbs.
Overall length:	4 1/2"
Direction of Chuck spindle	8 3/4"
Direction of motor	
Catalog No. (specify voltage)	287

Paddle
Switch

up to 3/8"
up to 1/2"
2500 R.P.M.*
1600 R.P.M.
13700 R.P.M.

3 3/8 lbs.

5 lbs.

4 1/2"

8 3/4"

287

Price, complete **\$62.00**

Standard Equipment—3-conductor cable and plug; geared threaded chuck and key; Universal motor; removable end cap to facilitate brush inspection.

Standard Voltages—115 or 220 (For other available voltages, see page 1).

Available on Special Order Only: 1/4" Shorty Drill with Toggle Switch in end cap Cat. No. 298 **\$62.00**

* Trade Mark Registered U. S. Pat. Off.

1/4" HEAVY-DUTY Ball-Bearing Drill

FOR CONSTANT production service. Die-cast aluminum housing with heavy-duty motor, gears and bearings. Plenty of power and long service built into this unit. For frequent bit changing use model with Keyless Chuck.

Specifications

Capacity: in Steel	Standard	Keyless Chuck
	Geared Chuck	
in Hardwood	up to 3/8"	up to 3/8"
Speed: No-load	up to 1/2"	up to 1/2"
Full-load	2000 R.P.M.	2000 R.P.M.
Weight: Net	1300 R.P.M.	1300 R.P.M.
Shipping	6 1/2 lbs.	6 1/2 lbs.
Overall Length	8 lbs.	8 lbs.
Catalog No. (specify voltage)	12"	12 1/4"
	32	386

Price, complete **\$52.50** **\$56.00**

Standard Equipment—3-conductor cable and plug; two-pole automatic-release switch; removable commutator cover; "universal" motor.

Standard Voltages—32, 115 or 220 (For other available voltages, see page 1).

Unit with Keyless Chuck has gear locking pin to hold spindle while hand-tightening the Chuck. See illustration of Keyless Chuck on next page.

5/16" HEAVY-DUTY Ball-Bearing Drill

FOR high-speed, production drilling. Heavy-Duty die-cast aluminum housings, heavy-duty motor and gears. Geared chuck and key are standard equipment. For frequent bit changing use the keyless chuck model which has a patented gear locking pin to hold spindle while hand-tightening the chuck.

Specifications

Capacity: in Steel	Standard	Keyless Chuck
	Geared Chuck	
in Hardwood	up to 5/16"	up to 5/16"
Speed: No-load (Standard)	up to 3/8"	up to 3/8"
Full-load	1400 R.P.M.	1400 R.P.M.
Weight: Net	925 R.P.M.	925 R.P.M.
Shipping	6 3/4 lbs.	6 3/4 lbs.
Overall Length	8 1/2 lbs.	8 1/2 lbs.
Catalog No. (specify voltage)	12 3/4"	12 3/4"
	360	387

Price, complete **\$55.00** **\$58.50**

Standard Equipment—3-conductor cable and plug; two-pole automatic-release switch and locking pin; removable commutator cover; "universal" motor.

Standard Voltages—115 or 220 (For other available voltages, see page 1).



Black & Decker

ELECTRIC
TOOL
HEADQUARTERS

3/8" Standard Ball-Bearing Drill

POPULAR general-purpose Drill with extra chuck capacity so often needed in "odd-job" work. Spindle speed suited to smaller Hole Saws, wood augers and twist drills. An excellent drill press in Bench Stand.

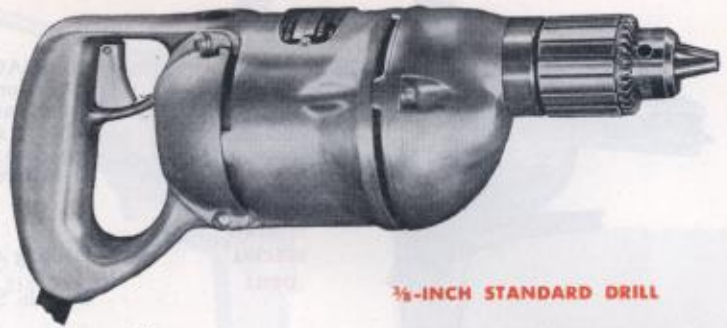

3/8-INCH STANDARD DRILL

Specifications

Capacity: in Steel	up to 3/8"
in Hardwood	up to 5/8"
Speed: No-load	900 R.P.M.*
Full-load	565 R.P.M.
Weight: Net	7 1/4 lbs.
Shipping	8 lbs.
Overall Length	12 1/2"

Catalog No. 490 (specify voltage)

Price, complete **\$55.00**

Standard Equipment—Automatic-release trigger switch with locking pin; 3-wire cable with plug; 3-jaw geared threaded chuck and key; "universal" motor.

*Optional no-load speeds (at no extra cost) 1400 or 2000 R.P.M.
Standard Voltages—115 or 220 (For other available voltages, see page 1).



KEYLESS
CHUCK

Keyless Chucks

These chucks need only hand pressure to be opened or tightened—saving time where bits are changed frequently. They can be furnished as standard equipment on 1/4" Heavy-Duty or 5/16" Heavy-Duty Drills with built-in gear-locking pins, when these Drills are ordered (see page 4) . . . or are available with a tightening collar as extra equipment for 1/4" Heavy-Duty, 5/16" Heavy-Duty or 3/8" Standard Drills without gear-locking pins.

COMPLETE LISTINGS of KEYLESS and OTHER REPLACEMENT CHUCKS are given on PAGE 12.

3/8" Heavy-Duty Drill

DESIGN and construction features same as the 1/2" Standard Drill. The spindle speed, weight and operating balance of this unit are ideal for production drilling of 3/8" holes at high speed.

Specifications

Capacity: in Steel.....	up to 3/8"	in Hardwood.....	up to 3/4"
Speed: No-load	900 R.P.M.	Full-load	700 R.P.M.
Weight: Net	9 1/2 lbs.	Shipping	12 1/4 lbs.
Overall Length	13 1/2"		

Standard Equipment—3-conductor cable and plug; 3-jaw geared threaded chuck and key; automatic-release trigger switch with locking pin; spade handle with key holder; detachable pipe handle; "universal" motor.

Standard Voltages—115 or 220 (For other available voltages, see page 1).

Catalog No. 362 (specify voltage)

Price, complete **\$60.00**



3/8-INCH
HEAVY-DUTY DRILL



Black & Decker

ELECTRIC
TOOL
HEADQUARTERS



**1/2-INCH
SPECIAL
DRILL**

**THE WORLD'S MOST POPULAR
GENERAL PURPOSE DRILL**

1/2" Special Drill

A PRACTICAL general purpose Drill with correct spindle speed for a wide variety of uses. Die-cast aluminum housings stand hard use, are light in weight. Ample power for intermittent service. 3-jaw geared chuck is threaded on spindle. Use this Drill to drive twist drills, wood augers, Hole Saws, in maintenance of machinery, equipment and appliances.

Specifications

Drilling Capacity: in Steel up to 1/2"
in Hardwood up to 1"
Spindle Speed: No-load 375 R.P.M.
Full-load 260 R.P.M.
Weight: Net 9 3/4 lbs.
Shipping 12 lbs.
Overall Length 13 1/2"
Standard Equipment—3-wire cable and plug; 3-jaw geared threaded chuck and key; automatic-release trigger switch with locking pin; spade handle with chuck-key holder; detachable pipe handle; "universal" motor.
Standard Voltages—115 or 220 (For other available voltages see page 1).

Catalog No. 38 (specify voltage) **\$47.50**
Price, complete

1/2" Standard Drill

THE MOST popular general purpose Electric Drill with perfect operating balance, close coupled construction, minimum spindle offset and horizontal spade handle. Spindle speed is ideal for driving all types of twist drills, Hole Saws and wood augers. Deep groove ball bearing chuck spindle with inner and outer races locked in place. Spline-mounted spindle gear increases strength, minimizes friction and wear.

Specifications

Capacity: in Steel up to 1/2"
in Hardwood up to 1"
Speed: No-load 400 R.P.M.
Full-load 300 R.P.M.
Weight: Net 9 3/4 lbs.
Shipping 13 lbs.
Overall Length 13 3/4"
Standard Equipment—3-conductor cable and plug; 3-jaw geared threaded chuck and key; automatic-release trigger switch with locking pin; spade handle with key holder; detachable pipe handle; "universal" motor.
Standard Voltages—115, 220 or 32 (For other available voltages, see page 1).

Catalog No. 361 (specify voltage) **\$60.00**
Price, complete

1/2" Heavy-Duty Ball-Bearing Drill

A CONSTANT-SERVICE production tool for heavy-duty drilling in metal, wood boring, driving Hole Saw and cylinder hones. Helical armature pinion and intermediate gear; alloy steel gears.

Specifications

Capacity: in Steel up to 1/2"; in Hardwood up to 1"
Speed: No-load (Standard) 500 R.P.M.*; Full-load . 330 R.P.M.
Weight: Net 17 lbs.; Shipping 19 1/2 lbs.
Overall Length 18 1/2"
Standard Equipment—3-conductor cable with plug; 3-jaw geared chuck, key and chain; automatic-release switch with locking pin; spade handle; detachable pipe handle; "universal" motor.
Optional—No. 2 Morse Taper Socket, instead of chuck, no extra charge.
Standard Voltages—115 or 220 (For other available voltages, see page 1).

Catalog No. 40 Standard Unit (specify voltage) **\$84.00**
Price, complete

Catalog No. 575 Reversing Switch Unit **\$94.00**
(specify voltage) **Price, complete**

*Special no-load speeds, 750 R.P.M. or 900 R.P.M. **\$.50 extra**



**1/2-INCH
STANDARD
DRILL**



**1/2-INCH
HEAVY-DUTY DRILL**



Black & Decker

ELECTRIC
TOOL
HEADQUARTERS

5/8" Standard Ball-Bearing Drill

MOTOR is mounted on ball bearings. Chuck spindle operates on Timken tapered roller bearings, insuring smooth power.

Specifications

Drilling Capacity:
in Steel 5/16" to 5/8"; in Hardwood 1 1/4"
Speed: No-load 300 R.P.M.; Full-load 200 R.P.M.
Weight: Net 17 lbs.; Shipping 21 3/4 lbs.
Overall Length 18"

Standard Equipment—3-wire cable and plug; 5/8" geared chuck, key and chain; automatic-release switch with locking pin; spade handle; detachable pipe handle; "universal" motor.

Optional—No. 2 Morse Taper Socket instead of chuck, no extra charge.

Standard Voltages—115 or 220 (For other available voltages, see page 1).

Catalog No. 238 (specify voltage)

Price, complete **\$79.00**

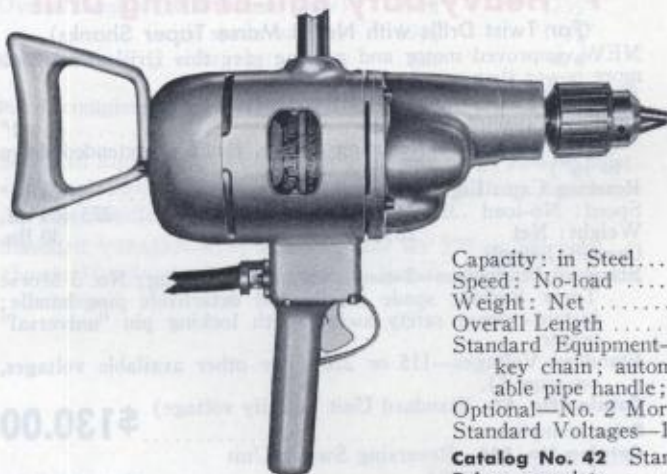
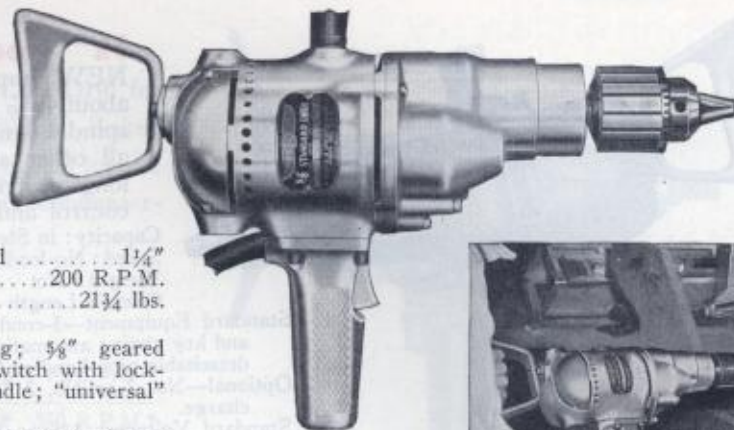

5/8" Heavy-Duty Ball-Bearing Drill

ROLLER-BEARING equipment on chuck spindle, to withstand severe side and end thrust; ball-bearing construction throughout. Amply powered and built for heavy-duty service.

Specifications

Capacity: in Steel 5/16" to 5/8"; in Hardwood up to 1 1/4"
Speed: No-load 450 R.P.M.; Full-load 320 R.P.M.
Weight: Net 21 1/4 lbs.; Shipping 27 3/4 lbs.
Overall Length 20"

Standard Equipment—3-conductor cable and plug; 3-jaw geared chuck, key and key chain; automatic-release switch with locking pin; spade handle; detachable pipe handle; "universal" motor.

Optional—No. 2 Morse Taper Socket, instead of chuck, no extra charge.

Standard Voltages—115 or 220 (For other available voltages, see page 1).

Catalog No. 42 Standard Unit (specify voltage) **\$105.00**

Price, complete

Catalog No. 576 Reversing Switch Unit (specify voltage) **\$115.00**

Price, complete

3/4" Standard Ball-Bearing Drill

A POWERFUL tool, with triple gear reduction for low spindle speed. Motor mounted on ball bearings, chuck spindle operates on Timken tapered roller bearings.

Specifications

Drilling Capacity:
in Steel 3/16" to 3/4"; in Hardwood 1 1/2"
Speed: No-load 250 R.P.M.; Full-load 175 R.P.M.
Weight: Net 19 1/4 lbs.; Shipping 25 1/2 lbs.
Overall Length 18 3/4"

Standard Equipment—3-wire cable and plug; 3/4" geared chuck, key and chain; automatic-release switch with locking pin; spade handle; detachable pipe handle; "universal" motor.

Optional—No. 2 or No. 3 Morse Taper Socket instead of chuck, no extra charge.

Standard Voltages—115 or 220 (For other available voltages, see page 1).

Catalog No. 239 (specify voltage)

Price, complete **\$88.00**

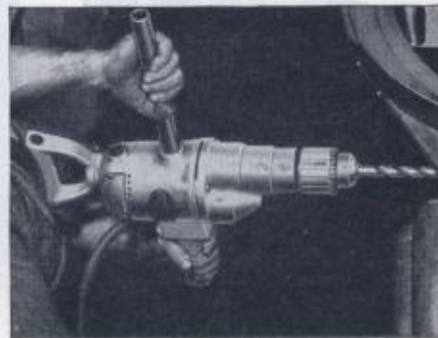



Black & Decker

ELECTRIC
TOOL
HEADQUARTERS



3/4" Heavy-Duty Ball-Bearing Drill

NEW, improved motor and gearing give this Drill about 40% more power than previous models. Chuck spindle equipped with Timken taper-roller bearings; all other shafts mounted on ball bearings. Extra long switch handle and pipe handle for complete control and balance.

Capacity: in Steel $\frac{3}{16}$ " to $\frac{3}{4}$ "; in Hardwood up to $1\frac{1}{2}$ "
Speed: No-load (Std.) 375 R.P.M.*; Full-load 280 R.P.M.
Weight: Net $27\frac{1}{4}$ lbs.; Shipping 34 lbs.
Overall Length 21"

Standard Equipment—3-conductor cable and plug; 3-jaw geared chuck, key and key chain; automatic-release switch with locking pin; spade handle; detachable pipe handle; "universal" motor.

Optional—No. 2 or No. 3 Morse Taper Socket instead of chuck, no extra charge.

Standard Voltages—115 or 220 (For other available voltages, see page 1).

Catalog No. 45 Standard Unit (specify voltage) **\$115.00**

Price, complete

Catalog No. 555 Reversing Switch Unit (specify voltage) **\$125.00**

Price, complete

*Special No-load Speeds; 275, 600, or 900 R.P.M. **\$5.00 extra**

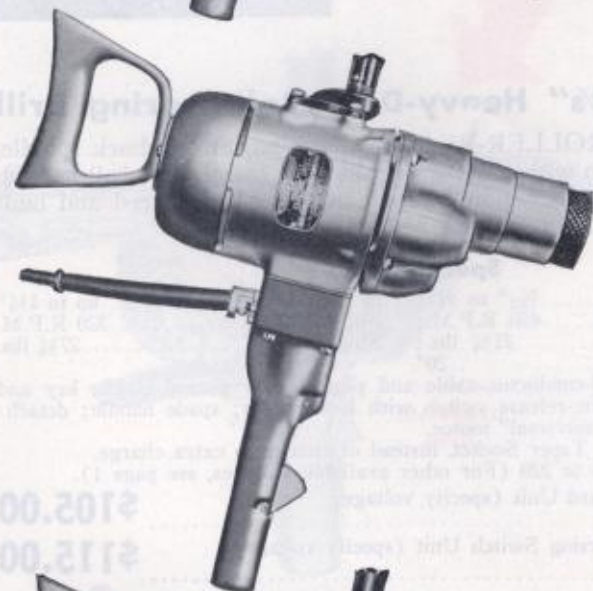

1" Heavy-Duty Ball-Bearing Drill

(For Twist Drills with No. 3 Morse Taper Shanks)

NEW, improved motor and gearing give this Drill about 25% more power than previous models.

Specifications

Drilling Capacity: in Steel 1"
(With 3-2 or 3-1 Reducing Sleeve, range is extended down to $\frac{1}{8}$ ")

Reaming Cap.: Light up to $\frac{3}{4}$ "; Heavy up to $\frac{5}{8}$ "

Speed: No-load 350 R.P.M.*; Full-load 275 R.P.M.

Weight: Net $28\frac{1}{2}$ lbs.; Shipping 30 lbs.

Overall Length 20"

Standard Equipment—3-conductor cable and plug; No. 3 Morse Taper Socket; spade handle and detachable pipe handle; instant-release safety switch with locking pin "universal" motor.

Standard Voltages—115 or 220 (For other available voltages, see page 1).

Catalog No. 47 Standard Unit (specify voltage) **\$130.00**

Price, complete

Catalog No. 556 Reversing Switch Unit

(specify voltage) **\$140.00**

Price, complete

*Special Speeds; 275, 600 or 900 R.P.M. **\$5.00 extra**



1 1/4" Heavy-Duty Ball-Bearing Drill

(For Twist Drills with No. 3 Morse Taper Shanks)

OUR LARGEST and most powerful Drill, with extra long safety switch and pipe handles. Motor housing is cast with adaptor pad to fit this Drill to No. 80 Drill Stand.

Specifications

Drilling Capacity: in steel up to $1\frac{1}{4}$ "
(With 3-2 or 3-1 Reducing Sleeve, range is extended down to $\frac{1}{8}$ ")

Reaming Cap.: Light up to 1"; Heavy up to $\frac{3}{4}$ "

Speed: No-load 250 R.P.M.*; Full-load 170 R.P.M.

Weight: Net 32 lbs.; Shipping 38 lbs.

Overall Length $20\frac{1}{2}$ "

Standard Equipment—3-conductor cable and plug; No. 3 Morse Taper Socket; spade handle and detachable pipe handle; instant-release safety switch with locking pin; "universal" motor.

Standard Voltages—115 or 220 (For other available voltages, see page 1).

Catalog No. 494 Std. Unit (specify voltage) **\$149.00**

Price, complete

Catalog No. 557 Reversing Switch Unit

(specify voltage) **\$159.00**

Price, complete

*Special No-load Speeds; 350, 600 or 900 R.P.M. **\$5.00 extra**



Black & Decker

ELECTRIC
TOOL
HEADQUARTERS

No. 225 Coal Drill

THE MOST popular size and capacity Coal Drill for constant service on regular shot-hole drilling. Suited to either one- or two-man use. Can be furnished for use on alternating current or with special condenser-equipped switches for direct current.

Specifications

	For Alternating Current	For Direct Current
Speed: No-load (Standard)	350 R.P.M.*	350 R.P.M.*
Full-load	200 R.P.M.	200 R.P.M.
*Optional Speed (no extra cost) ..	600 R.P.M.	600 R.P.M.
Weight: Net (with breast plate) ..	27½ lbs.	29 lbs.
Shipping	37 lbs.	38½ lbs.
Net (with spade handle) ..	26¼ lbs.	27¾ lbs.
Shipping	36 lbs.	32 lbs.
Overall length (with breast plate)	17½"	17½"
(with spade handle)	19¾"	19¾"
Cat. No. (specify voltage)	305	474

Price, complete **\$150.00 \$160.00**

Standard Equipment—3-conductor cable and plug; 20-amp. dust-proof switch, threaded spindle; breast plate†; detachable pipe handle.

Standard Voltages—115; also available for 220 or 240 volts.

†Spade Handle supplied in place of Breast Plate, at no extra charge.

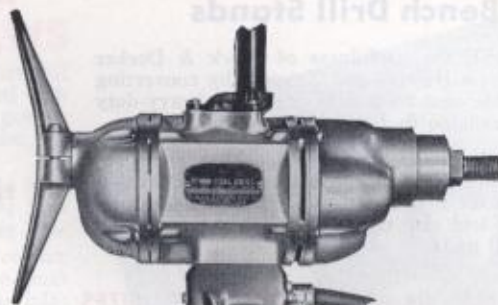

NO. 225 COAL DRILL WITH D.C. SWITCH HANDLE AND STANDARD BREAST PLATE.



NO. 225 COAL DRILL WITH A.C. SWITCH HANDLE AND OPTIONAL SPADE HANDLE.

Radial Arm

THIS Radial Arm is particularly adapted to chain production methods. Arm has vertical adjustment up and down column and can be swung to any desired position.

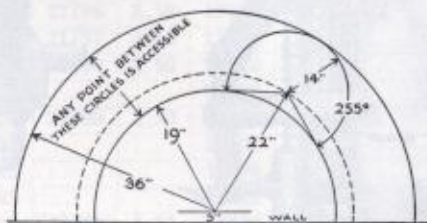

Travel of Arm on column	24"
Vertical travel of Bracket	4"
Angular adjustment, electrical tool bracket ..	255°
Angle of swing	180°
Distance, center of column to elbow	22"
Elbow to spindle electric tool	14"
Effective area of operation is within radii from 19" to 36" from column.	
Weight: Net	180 lbs.;
Shipping	221 lbs.

Catalog No. 20057 (type "C")

Price, complete **\$165.00**

In ordering be sure to specify type and size of Electric Tool to be used, so that the proper adapter will be supplied on the bracket.

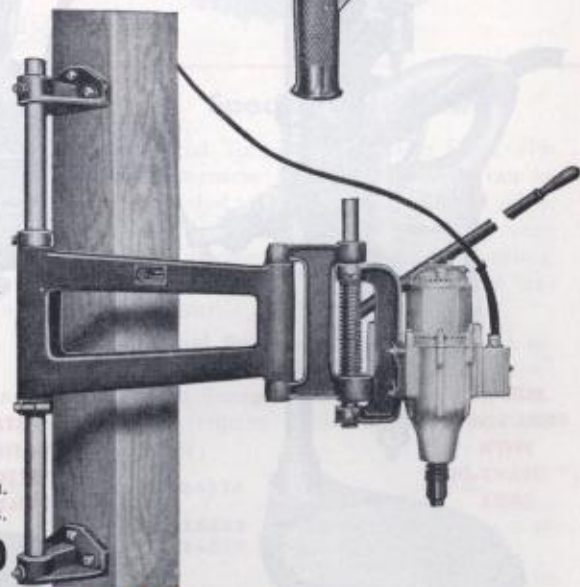

RADIAL ARM



Black & Decker

ELECTRIC
TOOL
HEADQUARTERS

Bench Drill Stands

INCREASE the usefulness of Black & Decker Drills, Screw Drivers and Tappers by converting the portable unit to a drill press for heavy-duty work. Available in Bench type for all sizes.

Handle leverage multiplies working pressure; feeds smoothly for accurate work. Tool bracket adjustable for height and radial position. Adjustments for tool size eliminate adapters; one stand fits several units.

AVAILABLE IN FOUR DIFFERENT SIZES TO ACCOMMODATE DRILL SIZES FROM 1/4-INCH TO 1 1/4-INCHES AND ALSO TAPPERS, SCRUGUNS AND SCREW DRIVERS.

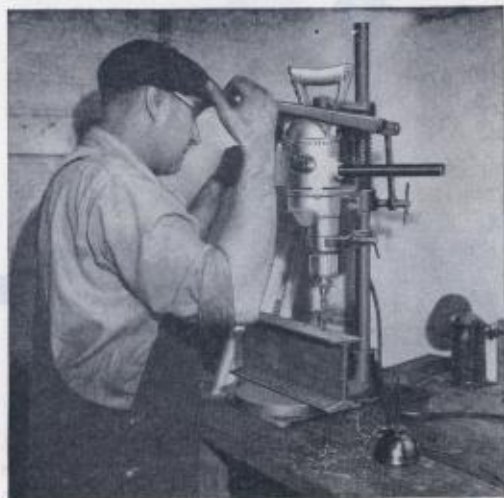

SIZE 20 DRILL STAND (TYPE C)—

Fits 1/4" Holgun, 1/4" Special, 1/4" Junior, 1/4" Standard, 1/4" Heavy-Duty, 3/16" Heavy-Duty, 3/8" Standard; the SCRUGUN, TAPGUN, No. 14 and No. 18 Screw-Drivers and 1/4" Tapper. Maximum feed is 2"; from C/L Bit to C/L Column is 5 1/4".

CAT. No. 22148

Net Weight 16 lbs.; shipping 19 1/2 lbs. Price.....\$22.00

SIZE 40 DRILL STAND (TYPE C)—

Fits 3/8" Heavy-Duty, 1/2" Special, 1/2" Junior, 1/2" Utility, 1/2" Standard Drills. Maximum feed is 4"; from C/L Bit to C/L Column is 6".

CAT. No. 22145

Net Weight 30 lbs.; shipping 37 lbs. Price.....\$29.00

SIZE 60 DRILL STAND (TYPE A)—

Fits all Black & Decker side-handle Drills from 1/2" Heavy-Duty to the 1" Heavy-Duty. Maximum feed is 4"; from C/L Bit to C/L Column is 8".

CAT. No. 13857

Net Weight 59 lbs.; shipping 69 lbs. Price.....\$49.00

SIZE 80 DRILL STAND (TYPE A)—

Fits the 1 1/4" Heavy-Duty Drill only. Maximum feed is 4"; from C/L Bit to C/L Column is 12".

CAT. No. 26607

Net Weight 73 lbs.; shipping 90 lbs. Price.....\$60.00



SIZE 20
DRILL STAND
WITH
1/4" HEAVY-DUTY
DRILL

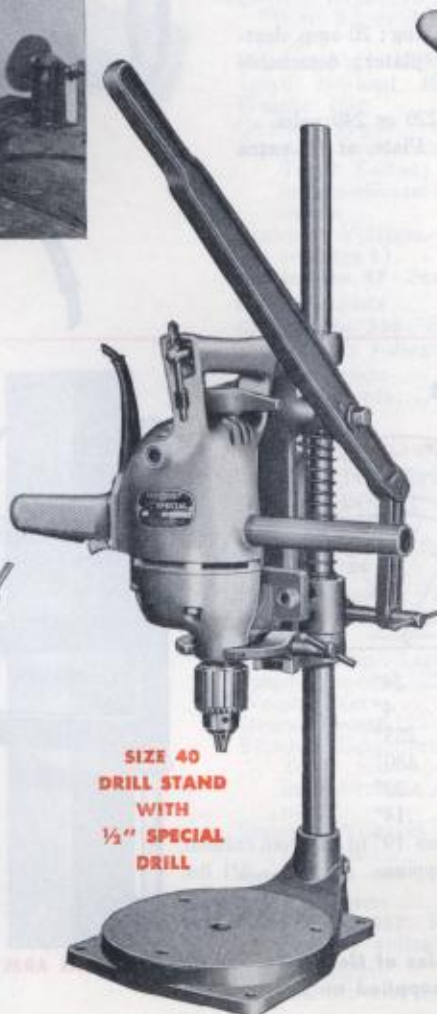

SIZE 40
DRILL STAND
WITH
1/2" SPECIAL
DRILL

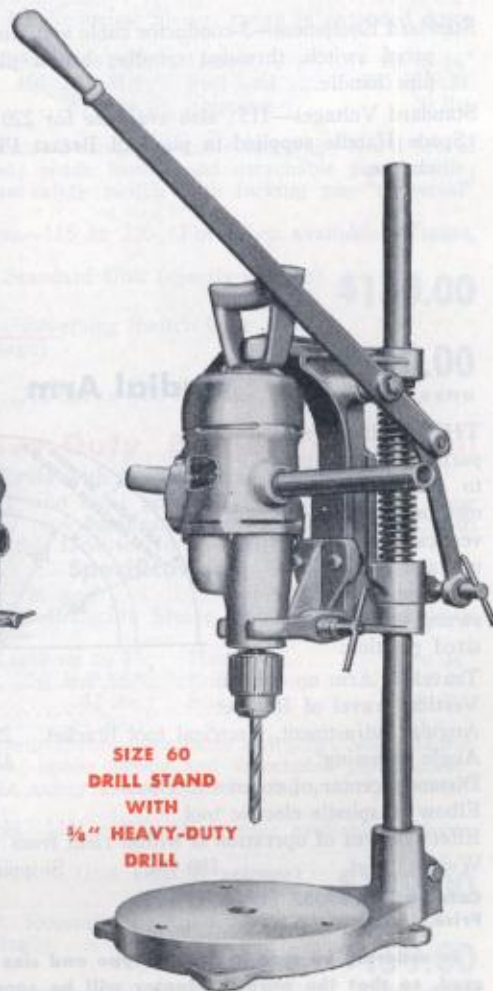

SIZE 60
DRILL STAND
WITH
3/4" HEAVY-DUTY
DRILL



Black & Decker

ELECTRIC
TOOL
HEADQUARTERS

A COMPLETE LINE OF HOLE SAWS

BLACK & DECKER Hole Saws will cut clean, round holes in any material a hacksaw will cut. They can be used with any Drill or spindle equipped with a correct chucking device, but the power and speed of the spindle will govern the size Hole Saw to be used and the results obtained. We suggest the following limits on Black & Decker Drills:

- On 1/4" low-speed HOLEGUN..... not larger than 1 1/4" Hole Saw
- On 3/8" Standard Drill..... not larger than 1 1/2" Hole Saw
- On 1/2" Special and 1/2" Standard..... not larger than 3 1/2" Hole Saw

Hole Saws are available in three types: *Coarse-tooth tungsten steel* for wood, fibre, bakelite, cast iron and all thick, coarse materials; *Fine-tooth tungsten steel* for sheet metal, steel, porcelain and all thin or sheet materials; *High-speed steel* for hard alloys and for longer service on production work. Hole Saws are interchangeable on Mandrels as indicated in the table below; each Mandrel includes a pilot drill which centers the Hole Saw and keeps the cutting concentric. Standard Hole Saws have approximately 3/4" depth-of-cut.

Saw Out- side Diam.	Tungsten Steel Saw			High Speed		Mandrels		For Con- duit Sizes	For Pipe Tap Sizes
	Fine Tooth Cat. No.	Coarse Tooth Cat. No.	Price Each Saw Only	Medium Tooth Cat. No.	Price Each Saw Only	For 3/8" or Larger Drills	For 1/4", 5/16" or 3/8" Drills		
5/8"	23051		\$1.80		\$.....	*	*
3/4"	16882	14906	.60	21747	1.40	14903	22181	3/8"
7/8"	16883	14908	.60	21748	1.40	14903	22181	1/2"
1 5/16"	21382		.60	21749	1.40	14903	22181	3/4"
1"	16884	14910	.60	21771	1.40	14903	22181
1 1/16"	21875	22953	.80	22809	1.40	14903	22181
1 1/8"	16885	14912	.80	21772	1.40	14903	22181	3/4"
1 3/16"	17678	17679	.80	21773	1.40	14903	22181	1"
1 1/4"	16886	14911	.80	21781	1.40	14904	22182
1 3/8"	16887	14913	.80	21782	1.40	14904	22182	1"
1 1/2"	16888	14914	.80	21783	1.40	14904	22182	1 1/4"
1 5/8"	16889	14915	.95	21784	1.40	14904
1 3/4"	16890	14916	.95	21785	1.85	14904	1 1/4"	1 1/2"
1 7/8"	16891	14917	.95	21786	1.85	14904
2"	16892	14918	1.10	21787	1.85	18028	1 1/2"
2 1/16"	16893	14919	1.10	21788	2.50	18028
2 1/8"	16894	14920	1.10	21789	2.50	18028
2 1/4"	16895	14922	1.30	21790	2.50	18028	2"
2 3/8"	16896	14921	1.30	21791	2.50	18028
2 1/2"	16897	14923	1.30	21792	2.50	18028	2"
2 5/8"	16898	14924	1.40	21793	2.50	18028
2 3/4"	16899	14925	1.40	21794	2.50	18028	2 1/2"
2 7/8"	16900	14927	1.40	21795	2.50	18028
3"	16901	14926	1.55	21796	2.50	18028	2 1/2"
3 1/8"	16902	14930	1.55	21797	2.50	18028
3 1/4"	16903	14929	1.55	21798	2.50	18028	3"
3 3/8"	24172	1.55	18028
3 1/2"	16904	14928	1.55	21799	2.50	18028	3"
3 5/8"	24173	1.85	18028
3 3/4"	24174	1.85	18028
3 7/8"	24175	1.85	18028
4"	16905	14932	1.85	21800	4.25	18028	3 1/2"

Mandrels for 1/4", 5/16" and 3/8" Drills

- No. 22181 Mandrel with Pilot Drill (to fit 3/4" to 1-3/16" Hole Saws)..... \$1.80
- No. 22182 Mandrel with Pilot Drill (to fit 1 1/4" to 1 1/2" Hole Saws)..... 1.85
- No. 22192 Pilot Drill only, for above Mandrels..... .45
- No. 23050 3/16" Pilot Drill for the No. 23051 Hole Saw only..... .35

* The No. 23051 Hole Saw has a built-in Mandrel; no separate Mandrel supplied.

Mandrels for 1/2" and Larger Drills

- No. 14903 Mandrel with Pilot Drill (to fit 3/4" to 1-3/16" Hole Saws)..... \$1.80
- No. 14904 Mandrel with Pilot Drill (to fit 1 1/4" to 1 1/2" Hole Saws)..... 1.85
- No. 18028 Mandrel with Pilot Drill (to fit 2" to 4" Hole Saws)..... 2.35
- No. 14935 Pilot Drill only, for above Mandrels..... .45



MANDREL

HOLE-SAW



Special Hole Saws

Special Tungsten Steel Hole Saws, with extra-coarse tooth arrangement, can be furnished at 50c more than standard prices in diameter up to 1 7/8"; at \$1.00 more than standard prices in 2" to 4" diameters. Give Hole Saw diameter and specify "extra-coarse" when ordering.

Special Depth Hole Saws—for home insulation and other special uses; coarse-tooth Tungsten Steel with 1 3/4" depth-of-cut; require special mandrels as listed below:

- No. 24576 2 1/2" Special Depth Hole Saw..... \$3.10
- No. 18635 3" Special Depth Hole Saw..... 3.10
- No. 24578 Special Mandrel with Pilot Drill to be used with above Hole Saws..... 2.35
- No. 24577 Pilot Drill for No. 24578 Mandrel..... .45



Black & Decker

ELECTRIC
TOOL
HEADQUARTERS

Jacobs Drill Chucks and Keys

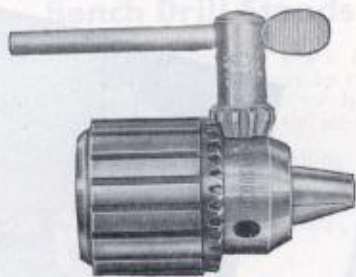

**DRILL CHUCK
AND KEY**

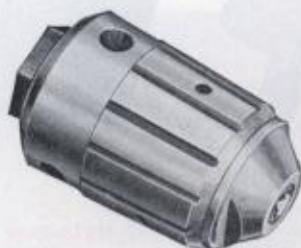

KEYLESS CHUCK

Chuck Size	Chuck and Key			Key Only*			Used on These Units
	Cat. No.	Mfgs. No.	Price	Cat. No.	Mfgs. No.	Price	
5/16" Threaded	23224	1-B8	\$ 6.00	3030-T	1	\$0.40	3/8" Hornet (type A) Shorty Drills (all types); 1/4" Ho- gun (A); 3/8" Junior (B); 3/4" Special (C)
3/8" Threaded	23226	1-B	5.50	3030-T	1	.40	
1/4" Tapered	3030	1-A	5.50	3030-T	1	.40	3/4" Special (A) (B); 3/4" Junior (A)
3/8" Threaded	34467	1-B	5.75	3030-T	1	.40	1/4" Special (C)
3/8" Tapered	7705	7	5.50	7705-L	7	.40	3/4" Heavy-Duty (A to G)
3/8" Threaded	23227	7-B	5.50	7705-L	7	.40	3/8" Heavy-Duty (H to M) 3/4" Standard (B, C, CP, CSP, D)
1/4" Threaded	23762	7-B 1/2-20 Tap 3/8-24 Tap	5.50	7705-L	7	.40	3/4" Holgun (B); H-D. Holgun
5/16" Threaded	23228	30-B	6.00	6133-L	30	.50	3/8" Utility; 5/16" H.-D. (L to T) Sanders, Polishers
3/8" Thread	34272	7 BTY 5/8-11 Tap	6.00	7705.L	7	.40	
5/16" Tapered	32376	421-01	11.00	16682		.10	3/8" (No. 8) Tappan, 3/4" Tappan
3/8" Threaded	23229	32-B	6.50	4794-L	32	.50	3/8" Standard (all types); 3/4" Utility (M to U); 5/8" H.-D. (N to T)
3/8" Tapered	7244	32-Drill	6.50	4794-L	32	.50	3/4" Utility (K, L)
3/8" Tapered	4794	32-Tap	6.50	4794-L	32	.50	3/4" (No. 22) & No. 2 Tappers (Std.)
3/8" Tapered	32377	441-02	12.50	20530		.10	3/4" (No. 22) & No. 2 Tappers (Spl.)
1/2" Threaded	23230	33-B	7.50	4794-L	32	.50	1/2" Junior (B); 3/8" Standard (B); 1/2" Utility (E, F); 3/4" Special (E)
1/2" Tapered	15839	33	7.50	4794-L	32	.50	1/2" Junior (A)
1/2" Tapered	9480	34	8.00	1534-L	3	.65	1/2" H.-D. (A to E); 1/2" Spl. (C, D)
5/8" Tapered	11329	3-A	9.50	1534-L	3	.65	5/8" Standard (D); 5/8" Utility (A); 5/8" Heavy Duty (A to D)
3/4" Tapered	9522	36	12.00	9522-L	4	.95	3/4" Standard (E); 3/4" Utility (A); 3/4" Heavy-Duty (all)

* "T" indicates T-shaped key; "L" indicates L-shaped key.

Keyless Chucks

Available as replacement equipment as follows. Either of the two catalog numbers listed below will fit 1/4" Heavy-Duty or 5/16" Heavy-Duty with gear locking pin.

- No. **34043A** Jacobs Keyless Chuck—0" to 3/4" capacity—Threaded \$ 9.50
 No. **36097A** Jacobs Keyless Chuck—0" to 5/16" capacity—Threaded 11.50

See listings under 1/4" Heavy-Duty and 5/16" Heavy-Duty Drills only for prices as original equipment with gear locking pin.

Rubber-Flex Chuck Key Holder

Attaches to electric cable by slipping its "noose" over cable plug. Chuck key handle must be wet with water for insertion into holder. Top quality rubber holds key firmly and gives plenty of flexibility for tightening chuck.

- No. **34518** (Jacobs size A) for Key nos. 0, 1, 7 and K61 \$.30
 No. **34519** (Jacobs size B) for Key nos. 2, 30, 32 and K6430
 No. **34520** (Jacobs size C) for Key no. 330



**RUBBER-FLEX
CHUCK KEY HOLDER**

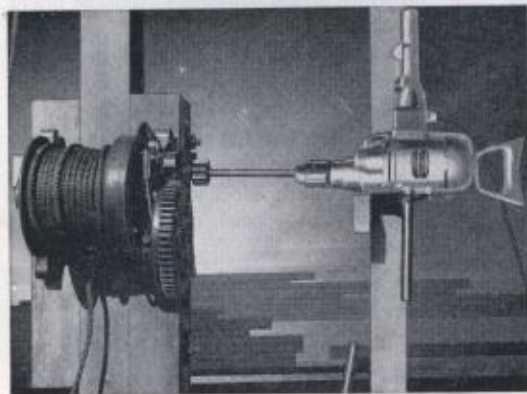

Unusual Tool Applications

All Black & Decker Tools are designed and built to perform a specific operation such as drilling, driving fasteners, shearing sheet metal, etc. However, ingenious production men have often adapted electric tools for use as an emergency source of power. An interesting example of this is shown at left.

A contractor, faced with an emergency need for hoisting equipment, rushed one of his Black & Decker 3/4" Heavy-Duty Drills into service to supply the power. The hoist driving gear was welded to a long shank held in the Drill chuck, and a "dog" held the gear engaged during the lift. The hoist has a lifting capacity of 1,000 pounds!

Horizontal Drill Stands

With this stand, Drills can be used for stationary drilling, reaming, light buffing, grinding and wire brushing. The stand is screwed or clamped to the bench and holds the Drill rigidly by means of an adjustable chain.

- No. **23046** Drill stand for $\frac{1}{4}$ " Std.; $\frac{1}{4}$ " Heavy-Duty;
 $\frac{5}{16}$ " Heavy-Duty; $\frac{3}{8}$ " Std. **\$4.75**
 Weight: Net..... $3\frac{3}{4}$ lbs.; Shipping..... 4 lbs.

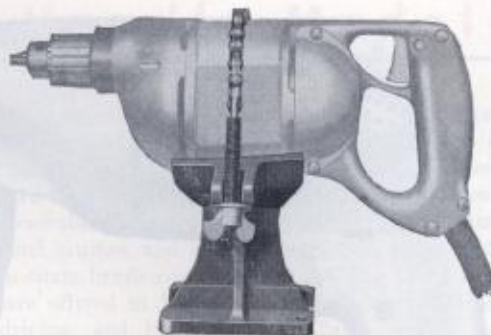

HORIZONTAL DRILL STAND

Right Angle Drilling Attachment (type "B")

To reach out-of-the-way places in work on joists, etc. Equipped with 3-Jaw Geared Chuck, $\frac{1}{2}$ " capacity.

- No. **17819** Right Angle Attachment for $\frac{1}{2}$ " Utility, and $\frac{1}{2}$ " Standard **\$42.00**
 No. **17820** Right Angle Attachment for $\frac{1}{2}$ " H.-D. (A to E); $\frac{5}{8}$ " Standard, and $\frac{5}{8}$ " Utility **42.00**
 No. **23574** Right Angle Attachment for $\frac{1}{2}$ " Junior, $\frac{1}{2}$ " Special..... **42.00**

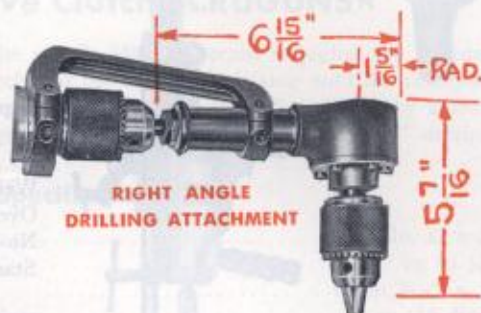

RIGHT ANGLE DRILLING ATTACHMENT

Feed Screw Attachment

Use for constant, steady feeding pressure. Mount in place of spade handle.

- No. **22555** For $\frac{1}{2}$ " Heavy-Duty (types B to E) **\$10.00**
 No. **19930** For $\frac{3}{8}$ ", $\frac{3}{4}$ " and $\frac{7}{8}$ " Utility; $\frac{5}{8}$ " Std. (D); $\frac{3}{4}$ " Std. (E) **10.00**
 No. **19960** For $\frac{1}{4}$ " H.-D. (type E to H); $\frac{3}{8}$ " H.-D. (types B to H); 1" H.-D. (types B to F); $\frac{1}{4}$ " H.-D. **10.00**



FEED SCREW

Wheel Arbors

Adapt $\frac{1}{4}$ " and $\frac{1}{2}$ " Drills to light grinding and wire brushing, by holding wheels in chuck of drill. Body of arbor is $\frac{1}{2}$ " diameter and will take 3" and 4" wheels.

- No. **3071** $\frac{1}{4}$ " Drill Arbor ($\frac{1}{2}$ " diam.; $\frac{1}{4}$ " shank) **\$.95**
 No. **8449** $\frac{1}{2}$ " Drill Arbor ($\frac{1}{2}$ " diam.; $\frac{1}{2}$ " shank) **1.95**

Sanding Pad Arbor

- No. **23041** Arbor for 5" Sanding Pad; fits $\frac{1}{4}$ ", $\frac{5}{16}$ ", $\frac{3}{8}$ " and $\frac{1}{2}$ " Drills ($\frac{5}{8}$ "-11 thr., $\frac{1}{4}$ " shank) **\$.85**

Gear Grease

A gear lubricant, best suited to portable electric tool use. Recommended for most electric tools, except Saws.

- No. **23638** 1 lb. Container of Standard Gear Grease **\$.90**
 No. **23639** 2 lb. Container of Standard Gear Grease **1.70**
 No. **32907** 5 lb. Container of Standard Gear Grease **3.85**

50 Ft. Extension Cable

To reach power outlets at a distance this cable will carry current without too great a drop in voltage. Consists of 14 gage, 3-wire, rubber covered cable complete with plugs.

- No. **11949** 50 ft. Extension Cable **\$15.50**

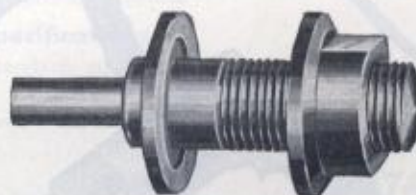

WHEEL ARBOR

CARBON REMOVING BRUSHES FOR DRILLS SHOWN ON PAGE 60



Black & Decker

ELECTRIC
TOOL
HEADQUARTERS

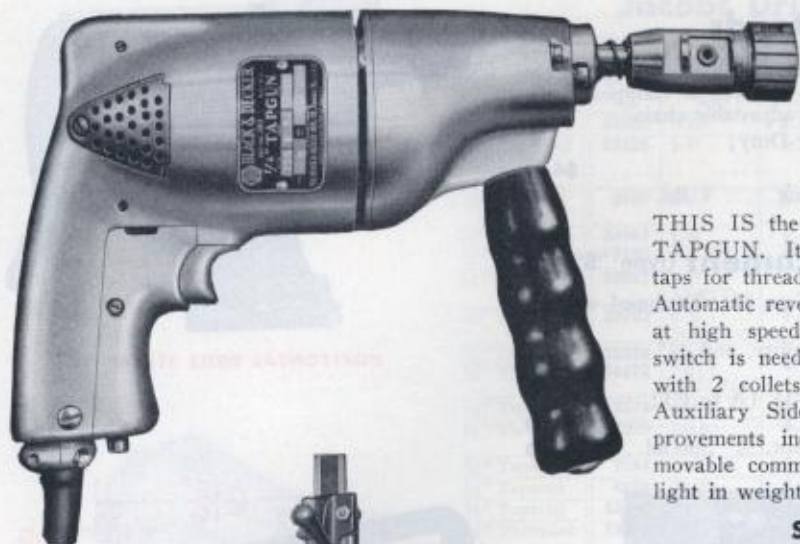

NEW

1/4-inch TAPGUN*

(Type C)

THIS IS the latest, improved version of the popular B&D TAPGUN. Its increased power is now ample to drive 1/4" taps for threading holes in steel, cast iron, brass or aluminum. Automatic reversing mechanism backs tap out of threaded hole at high speed when operator pulls backward—no reversing switch is needed. New Tapping Chuck (Jacobs No. 421-01) with 2 collets (0" to 3/4") (1/4" to .381") and Removable Auxiliary Side Handle are standard equipment! Other improvements include a more comfortable end handle and removable commutator and brush inspection plates. Tapgun is light in weight and very easy to handle.

Specifications

Tapping Capacity: In mild steel	1/4"
In cast iron	5/16"
In brass or aluminum	1/2"
Weight: Net	4 3/4 lbs.
Shipping	6 1/2 lbs.
Overall Length: 10 3/4" (including tap chuck)	
No-load spindle speed: Tapping	400 RPM
Reversing	525 RPM

Standard Equipment—Jacobs tap chuck with two collets (0" to 3/4" and 1/4" to .381"), 3-conductor cable and plug, 2-pole automatic release trigger switch with locking pin, detachable side handle, "universal" motor.

Standard Voltages—115 or 220 (For other available voltages see page 1).

Catalog No. 586 (specify voltage)

Price, complete **\$105.00**

No. 22148 Bench Stand (fits 1/4" Tapgun, 1/4" Holgun or No. 12 Scrugun) .. **\$22.00**

★ Trade Mark Reg. U. S. Pat. Off.



HOLGUN - TAPGUN - SCRUGUN

IDEAL FOR ASSEMBLY LINES, the Black & Decker matched production "Triplets" offer the following big advantages—

- (1) Light, balanced weight that reduces operator fatigue to a minimum.
- (2) Famous "Pistol Grip and Trigger Switch" plus small, compact housings make all three tools easy to handle and results in more accurate work.
- (3) Mechanical features include heavy-duty motors, complete ball-bearing equipment, heat-treated gears and splined shafts . . . they're built throughout for *continuous production service*.

For complete specifications—

See page 3 for the 1/4" HOLGUN Drill.

See above for the 1/4" TAPGUN.

See next page for the No. 12 SCRUGUN.

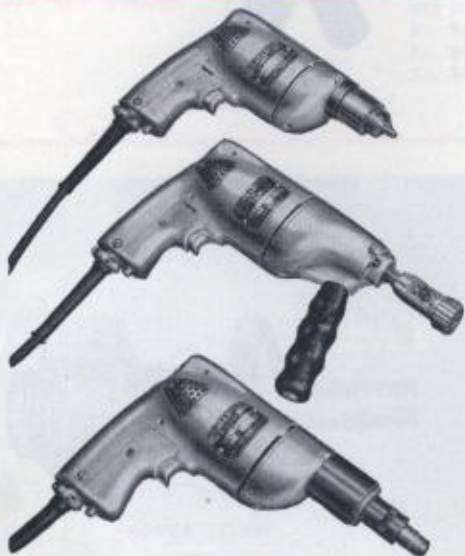



Black & Decker

ELECTRIC
TOOL
HEADQUARTERS

No. 12 SCRUGUNS - End Handle Models



**No. 12
POSITIVE CLUTCH
SCRUGUN**

Boasting a superlative record for speeding up all types of fastener assembly work, these late model Black & Decker SCRUGUNS have been given—(1) Increased motor power, (2) A handle shaped for more finger room, (3) A removable cover for convenient inspection of commutator and brushes, and (4) Cartridge-type brush holders to facilitate brush replacement. The No. 12 SCRUGUNS are offered in Positive Clutch models for "free-hand" driving, and in Adjustable Clutch models for driving each fastener automatically to a predetermined tightness.

No. 12 Positive Clutch SCRUGUNS★

In Positive Clutch Scruguns the spindle idles to permit engaging the fastener. Operating pressure closes the clutch and the tool keeps driving until the resistance of the fastener overcomes hand pressure . . . operator controls tightness by amount of pressure applied. This arrangement is ideal for portable "free-hand" driving.

Specifications

Capacity: Wood Screws up to No. 12 x 2"
Self-Tapping Screws up to 3/4"
Lag Screws up to 3/16" x 2"
Machine Screws and Nuts up to 1/4" diam.

No-load Standard Speed 600 R.P.M.*

Net Weight 3 3/4 lbs.; Shipping 5 lbs.

Overall Length (including bit) 9"

Standard Equipment—3-wire cable and plug; No. 15475 bit with protector, centering and spring sleeves; "universal" motor.

Standard Voltage—115 or 220. On special order 125 or 240 volts.

Cat. No. 402 Standard Unit (illustrated), Price (Specify Voltage) **\$59.50**

Cat. No. 572 Reversing Switch Unit, Price (Specify Voltage) **\$67.00**

*Optional speed (no extra charge)—1000 R.P.M.



No. 12 Adjustable Clutch SCRUGUN★

Adjustable Clutch Scruguns are the same as Positive Clutch models listed above except for the addition of a secondary clutch. On jobs where uniform tightness of fasteners is desirable (to meet specifications or prevent damage by driving fasteners too tight), the secondary clutch will disengage when the resistance of the fastener overcomes its pre-set spring load. Thus, automatically, each fastener is driven to a pre-determined, uniform tightness regardless of pressure applied.

Specifications

Capacity, Speeds, voltage and standard equipment same as No. 12 Positive Clutch Scrugun.

Net Weight 4 lbs.; Shipping 5 1/2 lbs.

Overall Length (including bit) 10 3/4"

Cat. No. 350 Standard Unit (illustrated), Price (Specify Voltage) **\$76.00**

Cat. No. 573 Reversing Switch Unit, Price (Specify Voltage) **\$83.50**



**No. 12
ADJUSTABLE
CLUTCH
SCRUGUN**

★Trade Mark Registered
U. S. Pat. Off.



Black & Decker

ELECTRIC
TOOL
HEADQUARTERS

NEW No. 8 SCRUGUN*

THIS HIGH-POWERED Center-drive Scrugun is the lightest and most compact tool we have ever built for driving up to No. 8 sized screws. Its clutch is controlled by two springs which permits automatically driving varying sized screws to a uniform degree of tightness. Paddle switch model operates conveniently in a horizontal or suspended position—turns "ON" as operator grasps tool and "OFF" as tool is released. Toggle switch is convenient for continuous operation.

Quality-built for high production service, the No. 8 Scrugun is equipped with ball bearings, heat-treated gears and a "universal" motor built specifically for this tool.

Specifications

- Capacity: Machine Screws and Nuts up to No. 8
 - Self-Tapping Screws up to No. 8
 - Wood Screws up to No. 8 x 1 1/4"
 - No-load Spindle Speed 3000 R. P. M.
 - Weight: Net—2 3/4 lbs.; Shipping—5 1/4 lbs.
 - Standard Equipment—3-conductor cable and plug; No. 13207 bit with centering sleeve; spring sleeve and protector; "universal" motor.
 - Standard Voltages—115 or 220 (For other available voltages see page 1). Specify voltage when ordering.
- | | |
|--|---------|
| Cat. No. 578 (with paddle switch) | \$92.00 |
| Cat. No. 580 (with paddle switch and reversing switch) | 99.50 |
| Cat. No. 579 (with toggle switch in end cap) | 89.00 |
| Cat. No. 581 (with toggle switch and reversing switch) | 96.50 |



* Trade Mark Registered
U. S. Pat. Off.

No. 12 90°-Angle Adjustable Clutch SCRUGUN*

These units with 90°-angle heads are particularly adapted to jobs with very limited working clearances. Two different 90° Scruguns are available as follows:

- (1) WITH HEAD No. 105 which has a 1/4" square shank to fit Sockets—to drive nuts, bolts and cap screws.
- (2) WITH HEAD No. 157 for use with screw driver bits and finders. "Dead spindle" clutch permits a stationary bit while engaging the screw slot. Specify bit and finder desired from table on page 19.



Specifications

- Capacity and Voltages same as No. 12 Scrugun. No-load Speed: 500 R.P.M. (Optional Speed 750 R.P.M.)
- Weight: Net 4 3/4 lbs.; Shipping 6 1/4 lbs. Overall Length 11 1/4"
- Cat. No. 374 (Specify Voltage and Head Number. If No. 157 Head, specify also bit and finder)
- Price, complete—With No. 105 Head \$106.00
- With No. 157 Head 130.00

See page 20 for drawings and specifications of Right Angle Heads.

The ADJUSTABLE Clutch

AN ADJUSTABLE Clutch is built into various models of SCRUGUNS and SCREW DRIVERS as specified on pages 15 through 18. On jobs where uniform tightness of the fasteners is desired, it is necessary to employ this secondary clutch in addition to the primary or "dead spindle" clutch which is merely used to permit a stationary spindle while engaging the fastener. The Adjustable clutch is interposed between the dead spindle clutch and the driving spindle, and, with proper setting of the adjusting nut against the spring, will disengage when the driving resistance of the fastener overcomes the spring load. Where conditions are uniform this will permit uniform tightness of the fasteners. Under varying conditions such as wood screw driving, where densities vary, it will be necessary to permit the adjustable clutch to ratchet several times in order to "creep" the fastener to the desired tightness.

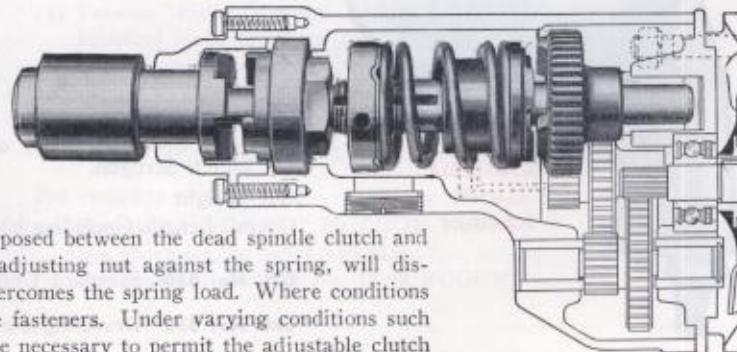

No. 14 Positive Clutch Screw Driver

(For Screw Driving and Nut Running)

POSITIVE PIN-TYPE clutch in the driving spindle idles until the bit "finds" the screw slot.

Specifications

Capacity: Wood screws up to No. 14 x 2½".
 Self-tapping screws up to 5/16" diam.
 Lag screws up to ¼" x 2".
 Machine screws and nuts up to 3/8" diam.
 Standard No-load speed 500 R.P.M.*
 Weight: Net 6¾ lbs.; Shipping 9 lbs.
 Overall length (not including bit) 13¼".
 Standard equipment—Quick-change chuck, with 7/16" hex. socket; 20° positive clutch; 3-conductor cable and attachment plug; and one each No. 5330 and No. 5344 Standard Bits with finders; automatic-release switch with locking pin; "universal" motor.

Catalog No. 53 Standard Unit, Price complete (specify voltage) **\$72.00**

Catalog No. 563 Reversing Switch Unit, Price complete (specify voltage) **\$79.50**

Standard Voltages—115 or 220 (For other available voltages, see page 1).

*Special Speeds—750, 1000, or 1600 R.P.M. **\$2.50 extra**

Special 13° or 30° clutch, instead of standard angle **2.50 extra**

No. 14 Adjustable Clutch Screw Driver

(For Screw Driving and Nut Running)

Specifications

Capacity: Same as above.
 Standard No-load speed 500 R.P.M.*
 Net Weight 8 lbs.; Shipping 12 lbs.
 Overall length (not including bit) 15½".
 Standard Equipment—3-conductor cable and plug; quick-change chuck with 7/16" hex. socket; adjustable clutch; one each No. 5330 and No. 5344 Standard Bits with finders; automatic-release switch with locking pin; "universal" motor.
 Standard Voltages—115 or 220 (For other available voltages, see page 1).

Catalog No. 169 Standard Unit, Price complete (specify voltage) **\$99.00**

Catalog No. 564 Reversing Switch Unit, Price complete (specify voltage) **\$106.50**

*Special speeds—750, 1000 or 1600 R.P.M. **\$2.50 extra**

No. 14 90°-Angle Adjustable Clutch Screw Driver

(For Screw Driving and Nut Running)

A NUMBER of right-angle heads adapt this tool to special assembly operations.

Specifications

Capacity: Same as above.
 Standard No-load speed 500 R.P.M.*; Overall length 18¼".
 Weight: Net 9½ lbs.; Shipping 13 lbs.
 Standard Equipment—3-conductor cable and plug; special geared end and one right-angle head; automatic-release switch; "universal" motor.

Available Right-Angle Heads and Catalog Numbers:

Head (Part No.)	Equipped with:	Catalog No. (Standard Unit)	Price Complete	Catalog No. (Reversing Switch Unit)	Price Complete
300	½" Square Shank	172-300	\$127.00	565-300	\$134.50
301	½" Hex. Socket	172-301	127.00	565-301	134.50
303	3/8" Square Shank	172-303	127.00	565-303	134.50
305	½" Square Shank	172-305	137.00	565-305	144.50
308	5/8" Hex. Socket	172-308	127.00	565-308	134.50
350	7/16" Hex. Chuck	172-350	127.00	565-350	134.50

Standard Voltages—115 or 220 (For other available voltages, see page 1).

*Special speeds—350 or 700 R.P.M. **\$2.50 extra**

Catalog No. 22148 Bench Stand for No. 14 and No. 18 Drivers **\$22.00**



No. 14
POSITIVE
CLUTCH
DRIVER

No. 14
ADJUSTABLE
CLUTCH
DRIVER

No. 14
90° ANGLE
DRIVER



Black & Decker

ELECTRIC
TOOL
HEADQUARTERS

No. 18 Positive Clutch Screw Driver

(For Screw Driving and Nut Running)

Specifications

Capacity: Wood screws up to No. 18 x 3½"
 Lag screws up to 5/16" x 3"
 Self-tapping screws up to 3/8" diameter.
 Machine screws and nuts up to 1/2" diameter.
 Standard No-load speed 500 R.P.M.*

Weight: Net 9 lbs.; Shipping 11¾ lbs.
 Overall Length (not including bit) 14¼"

Standard Equipment—Quick-change chuck, with 7/16" hex. socket; 20° positive clutch; 3-conductor cable and plug; and one each No. 5343 and No. 5329 Standard Bits with finders; automatic-release switch with locking pin; "universal" motor.

Standard Voltages—115 or 220 (For other available voltages, see page 1).

Catalog No. 54 Standard Unit, Price complete (specify voltage) **\$82.00**

Catalog No. 566 Reversing Switch Unit, Price complete (specify voltage) **\$89.50**

*Special speeds—750, 1000 or 1600 R.P.M. **\$2.50 extra**
 Special 13° or 30° Clutch, instead of standard angle **2.50 extra**

No. 18
POSITIVE
CLUTCH

No. 18 Adjustable Clutch Screw Driver

(For Screw Driving and Nut Running)

Specifications

Capacity: Same as above.
 Standard No-load speed 500 R.P.M.*
 Net Weight 10½ lbs.; Shipping 16 lbs.
 Overall Length (not including bit) 17¼"

Standard Equipment—3-conductor cable and plug; quick-change chuck with 7/16" hex. socket; adjustable clutch; one each No. 5343 and No. 5329 Standard Bits with finders; automatic-release switch with locking pin; "universal" motor.

Standard Voltages—115 or 220 (For other available voltages, see page 1).

Catalog No. 164 Standard Unit, Price complete (specify voltage) ... **\$108.00**

Catalog No. 567 Reversing Switch Unit, Price complete (specify voltage) **\$115.50**

*Special speeds—750, 1000 or 1600 R.P.M. **\$2.50 extra**

No. 18
ADJUSTABLE
CLUTCH

No. 18 90°-Angle Adjustable Clutch Screw Driver

(For Screw Driving and Nut Running)

Specifications

Capacity: Same as above.
 Standard No-load speed 500 R.P.M.*; Overall Length 19½"
 Weight: Net 12 lbs.; Shipping 18 lbs.

Standard Equipment—3-conductor cable and plug; special geared end and one right-angle head; automatic-release switch; "universal" motor.

Available Right-Angle Heads and Catalog Numbers.

Head (Part No.)	Equipped with:	Catalog No. (Standard Unit)	Price Complete	Catalog No. Reversing Switch Unit	Price Complete
300	1/2" Square Shank	167-300	\$136.00	568-300	\$143.50
301	1/2" Hex. Socket	167-301	136.00	568-301	143.50
303	3/8" Square Shank	167-303	136.00	568-303	143.50
305	1/2" Square Shank	167-305	146.00	568-305	153.50
308	3/8" Hex. Socket	167-308	136.00	568-308	143.50
350	7/16" Hex. Chuck	167-350	136.00	568-350	143.50

Standard Voltages—115 or 220 (For other available voltages, see page 1).

*Special Speeds—350 or 700 R.P.M. **\$2.50 extra**

Catalog No. 22148 Bench Stand for No. 14 and No. 18 Drivers **\$22.00**

No. 18
90° ANGLE
DRIVER



Black & Decker

ELECTRIC
TOOL
HEADQUARTERS

Standard Screw Driver Bits

With 1/4" Hex. Shanks—For Scruguns and Torsimeter



For use with these Screw Types and Sizes	Bit Length	Bit and Stan'd. Finder Assem. (B and C)	Price Each	Bit Only No. (A)	Price Each
Nos. 2, 3 Wood, No. 2 Machine (except Filister), No. 3 Machine, No. 2 Sheet Metal, No. 4 Filister.	1 1/4"			18051	\$0.60**
	2 3/4"			22396	.85**
Nos. 4, 5, 6 Wood, No. 4 Machine (except Filister), Nos. 5, 6 Machine, Nos. 4, 5 Sheet Metal, No. 6 Sheet Metal (except Stove).	1 1/4"			13208	.60**
	2 3/4"	17690	\$1.60**	17688	.85**
	5 1/4"	22111	2.15	22108	1.40
Nos. 7, 8 Wood, No. 6 Stove, Nos. 7, 8 Sheet Metal, No. 8 Machine, No. 10 Filister.	1 1/4"			13207	.60**
	2 3/4"	13356	1.60**	13353	.80**
	5 1/4"	13469	2.15	13470	1.40
Nos. 9, 10, 11 Wood, No. 10 Sheet Metal, No. 10 Machine (except Filister), No. 12 Filister.	1 1/4"			15475	.65**
	2 3/4"			23494	1.00**
	2 3/4"	18593	1.75**	18594	1.00**
No. 12 Wood, No. 12 Sheet Metal, No. 12 Machine (except Filister), 1/4" Filister	1 1/4"			16772	.85**
	2 3/4"	21731	1.80**	21730	1.05**

Standard Screw Driver Bits with 7/16" Hex. Shanks— for No. 14 and No. 18 Drivers

For use with these Screw Types and Sizes	Bit Length	Bit and Stan'd. Finder Assem. No. (E)	Price Each	Bit Only No. (D)	Price Each
Nos. 4, 5, 6 Wood, No. 4 Machine (except Filister), Nos. 5, 6 Machine, Nos. 4, 5 Sheet Metal, No. 6 Sheet Metal (except Stove).	2 1/2"	5345	\$1.55**	5104	\$0.75**
	6"	15086	2.50	15050	1.70
Nos. 7, 8 Wood, No. 6 Stove, Nos. 7, 8 Sheet Metal, No. 8 Machine, No. 10 Filister.	2 1/2"	5346	1.55**	5106	.75**
	6"	15090	2.50	15054	1.70
Nos. 9, 10, 11 Wood, No. 10 Sheet Metal, No. 10 Machine (except Filister), No. 12 Filister.	2 1/2"	5330	1.55**	5108	.75**
	6"	15094	2.50	15058	1.70
No. 12 Wood, No. 12 Sheet Metal, No. 12 Machine (except Filister), 1/4" Filister.	2 1/2"	5343	1.55**	5110	.75**
	6"	15098	2.50	15062	1.70
No. 14 Wood, No. 14 Sheet Metal, 1/4" Machine (except Filister).	2 1/2"	5344	1.55**	5112	.75**
	4"	15101	2.30	15065	1.55
	6"	15102	2.50	15066	1.70
No. 16 Wood, 5/16" Filister.	2 1/2"	5329	1.55**	5114	.75**
	6"	15106	2.50	15070	1.70
No. 18, 3/16" Sheet Metal.	2 5/8"	5364	1.95**	5116	.90**
	2 3/4"	5366	2.40	5118	1.20
5/16" Machine (except Filister), No. 20 Wood, 3/8" Filister.					
No. 24 Wood, 3/8" Machine (except Filister).	2 3/4"	5369	2.80	5120	1.45

* All lengths shown are the **projecting lengths**, from chuck to end of bit; they do **not** indicate overall lengths.

** **Quantity Prices**—Standard Bits and Bit-Finder Assemblies in this group are packed and stocked in boxes of six. We recommend ordering in standard packages or multiples thereof and offer special quantity prices in table at right, which apply on designated quantities, all of one size only.

One	In Box of Six, Each	1/2 Gross or More, Each
\$0.60	\$0.55	\$0.50
.65	.60	.55
.75	.70	.65
.80	.75	.70
.85	.80	.75
.90	.85	.80
1.00	.95	.90
1.05	1.00	.95
1.55	1.50	1.45
1.60	1.55	1.50
1.75	1.70	1.65
1.80	1.75	1.70
1.95	1.90	1.85



Black & Decker

ELECTRIC
TOOL
HEADQUARTERS

Screw Driver Bits for Phillips Head Screws



PHILLIPS HEAD BITS

A SPECIAL bit is required for driving the Phillips Head Screw, which has a cross form slot instead of the conventional slot and four different slot sizes designated as Nos. 1, 2, 3 and 4. Several screw sizes are covered by one slot size; see Table No. 1. Bits available for Black & Decker Screw Drivers are listed in Table No. 2.

Table No. 1

Type of Screw		Slot No. 1	Slot No. 2	Slot No. 3	Slot No. 4
Wood Screws	Flat and Oval Head	No. 4 and Smaller	No. 5 to No. 9	No. 10 to No. 16	No. 18 to No. 24
	Round Head	No. 4 and Smaller	No. 5 to No. 10	No. 11 to No. 16	No. 18 to No. 24
Stove Bolts	Flat, Oval and Oven Head	$\frac{3}{8}$ " and $\frac{1}{2}$ "	$\frac{3}{4}$ "	$\frac{1}{2}$ " to $\frac{3}{2}$ "
	Round Head	$\frac{3}{8}$ " and $\frac{1}{2}$ "	$\frac{3}{4}$ " and $\frac{5}{8}$ "	$\frac{3}{4}$ " and $\frac{1}{2}$ "
Machine Screws	Flat, Oval and Binding Head	No. 4 and Smaller	No. 5 to No. 10	No. 12 and $\frac{3}{4}$ "	$\frac{1}{2}$ " to $\frac{3}{2}$ "
	Round and Fillister Head	No. 4 and Smaller	No. 5 to No. 10	No. 12 to $\frac{1}{2}$ "	$\frac{3}{4}$ " and $\frac{1}{2}$ "
	Truss Head	No. 5 and Smaller	No. 6 to No. 10	No. 12 and $\frac{3}{4}$ "	$\frac{1}{2}$ " to $\frac{1}{2}$ "
Sheet Metal Screws	Flat, Round, Oval, Binding and Stove Head	No. 4 and Smaller	No. 5 to No. 10	No. 12 and No. 14

Table No. 2

Slot Size	Cat. No.	Unit Used With	Price Each	Price Each	
				Box of 6*	$\frac{1}{2}$ Gross Lots*
No. 1 ($\frac{3}{4}$ " hex. shank)	17922	Torsimeter and Scrugun	\$.70	\$.65	\$.55
No. 1 ($\frac{1}{2}$ " hex. shank)	18938	Nos. 14 and 18 S. D.	.90	.85	.75
No. 2 ($\frac{3}{4}$ " hex. shank)	17923	Torsimeter and Scrugun	.70	.65	.55
No. 2 ($\frac{1}{2}$ " hex. shank)	17924	Nos. 14 and 18 S. D.	.90	.85	.75
No. 3 ($\frac{1}{2}$ " hex. shank)	21366	Torsimeter and Scrugun	.70	.65	.55
No. 3 ($\frac{1}{8}$ " hex. shank)	17925	Nos. 14 and 18 S. D.	.90	.85	.75
No. 4 ($\frac{1}{8}$ " hex. shank)	17926	Nos. 14 and 18 S. D.	.90	.85	.75

$\frac{3}{4}$ " hex. shank bits have a projecting length (from chuck to bit end) of $1\frac{1}{4}$ ".
 $\frac{1}{2}$ " hex. shank bits have a projecting length (from chuck to bit end) of $2\frac{1}{4}$ ".
 *Quantity prices apply only on designated quantities of one size only.

Right-Angle Head Specifications

RIGHT ANGLE HEADS as detailed below are available for No. 12 Scruguns and Nos. 14 and 18 Screw Drivers which are listed on pages 16 through 18.

FOR NO. 12 SCRUGUNS

Head No. 105—Has $\frac{1}{4}$ " square shank to fit $\frac{1}{4}$ " drive opening in Sockets listed on next page.

Head No. 157—Has $\frac{1}{4}$ " hex chuck to take Bits and Finders listed on page 19. "Dead spindle" clutch permits a stationary bit while engaging the screw slot.

FOR NOS. 14 AND 18 SCREW DRIVERS

Head No. 300—Has $\frac{1}{2}$ " square shank to fit Sockets

Head No. 303—Has $\frac{3}{8}$ " square shank to fit Sockets

Head No. 305—Has $\frac{1}{2}$ " square shank to fit Sockets. "Dead spindle" clutch permits stationary spindle while engaging fastener.

Head No. 301—Has $\frac{1}{2}$ " hexagon socket for direct tightening of nuts, bolts and cap screws. Clearance hole for bolt shank in tightening nuts is $\frac{1}{2}$ " diameter x $\frac{7}{8}$ " deep.

Head No. 308—Has $\frac{3}{8}$ " hexagon socket. Clearance hole $\frac{1}{2}$ " diameter x 1" deep. Same usage as for Head No. 301.

Head No. 350—Has $\frac{1}{16}$ " hex chuck to take Bits and Finders listed on page 19.

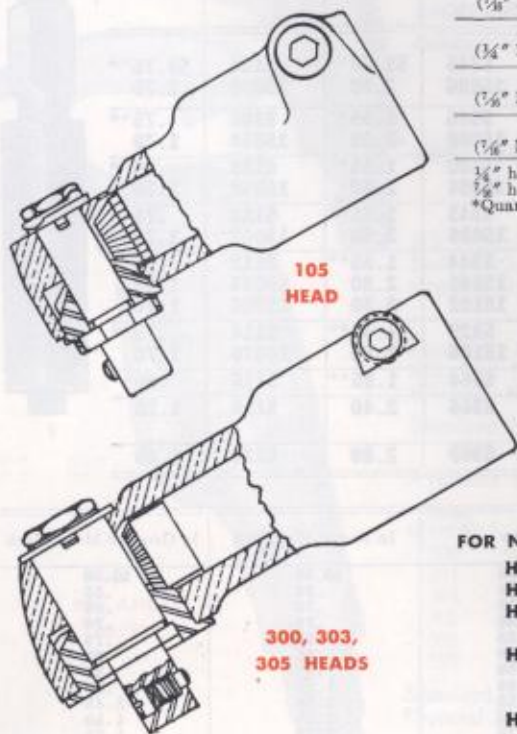

RIGHT-ANGLE HEADS



Black & Decker

**ELECTRIC
TOOL
HEADQUARTERS**

Special Hex. Drive Bits

for Hollow Head Cap Screws

This special type of screw has a driving recess consisting of a hexagon-shaped socket requiring a bit with a hexagon driving end. We can supply correct bits for driving these special screws in both the $\frac{1}{4}$ " hex. shank and $\frac{7}{16}$ " hex. shank size. Thus these bits are adapted to all Drivers from Scruguns to the No. 18.



Cat. No.	Diam. Across Flat on Driving End of Bit	Size Screws with which Bit is Used				Price Each
		Ex-tension of Bit	Cap Screws	Set Screws	Pipe Plugs	
Hex. Drive Bits with $\frac{1}{4}$ " Hex. Shanks						
18577	$\frac{1}{8}$ "	$1\frac{1}{4}$ "	#8	$\frac{1}{8}$ "	...	\$2.35*
18578	$\frac{1}{8}$ "	$1\frac{1}{2}$ "	#10 & #12	$\frac{1}{8}$ "	...	2.35*
18579	$\frac{1}{8}$ "	$1\frac{3}{4}$ "	$\frac{1}{8}$ "	$\frac{1}{8}$ "	$\frac{1}{8}$ "	2.35*
Hex. Drive Bits with $\frac{7}{16}$ " Hex. Shanks						
17892	$\frac{3}{16}$ "	2"	$\frac{1}{4}$ "	$\frac{3}{16}$ "	$\frac{1}{8}$ "	\$2.75†
19223	$\frac{1}{2}$ "	2"	$\frac{1}{4}$ "	$\frac{7}{16}$ "	...	2.75†
26842	$\frac{1}{2}$ "	2"	...	$\frac{3}{4}$ " Allen	$\frac{1}{4}$ "	2.75†
18977	$\frac{3}{8}$ "	2"	$\frac{3}{4}$ " & $\frac{7}{16}$ "	$\frac{3}{8}$ "	$\frac{3}{8}$ "	2.75†
23492	$\frac{3}{8}$ "	2"	$\frac{3}{4}$ " & $\frac{7}{16}$ "	$\frac{3}{4}$ "	$\frac{3}{4}$ "	2.75†

* In box of 6—each **\$2.30** † In box of 6—each **\$2.70**
 * $\frac{1}{2}$ gross lot—each **2.25** † $\frac{1}{2}$ gross lot—each **2.65**

Bit Extensions

Screw Driver Bit Extensions are available in 6" and 10" lengths, with $\frac{1}{4}$ " or $\frac{7}{16}$ " shank to fit Scrugun, Torsimeter or Screw Driver Chuck, and a chuck socket to take standard bits and socket wrenches. These Extensions greatly reduce bit replacement costs, where long bits are needed.

Cat. No.	Length	Shank Size	Price Each
22539	6"	$\frac{1}{4}$ "	\$2.00
22323	10"	$\frac{1}{4}$ "	2.10
14989	6"	$\frac{7}{16}$ "	2.00
5288	10"	$\frac{7}{16}$ "	2.40



Socket Wrenches

"Socket Size" indicates opening to fit nut or bolt to be driven; available in hexagon or double-square openings. "Drive Opening" in socket fits corresponding "drive square" on shank; match these sizes when ordering. $\frac{1}{4}$ " Shank Size fits all Scruguns and Torsimeter; $\frac{7}{16}$ " Shank Size fits Nos. 14 and 18 Drivers.

SOCKETS						SHANKS				
Socket Size	Drive Opening	Cat. No. Hexagon Socket	Price Each	Cat. No. Double-Square	Price Each	Shank Size	Drive Square Size	Overall Length	Cat. No.	Price Each
$\frac{1}{4}$ "	$\frac{1}{4}$ "	20512	\$0.75	20519	\$0.95	$\frac{1}{4}$ "	$\frac{1}{4}$ "	2"	20510	\$1.10
$\frac{5}{16}$ "	$\frac{1}{4}$ "	20513	.75	20520	.95					
$\frac{3}{8}$ "	$\frac{1}{4}$ "	20514	.75							
$\frac{7}{16}$ "	$\frac{1}{4}$ "	20515	.75							
$\frac{1}{2}$ "	$\frac{1}{4}$ "	20516	.75							
$\frac{5}{8}$ "	$\frac{1}{4}$ "	20517	.75							
$\frac{3}{4}$ "	$\frac{1}{4}$ "	20518	.80							
$\frac{1}{2}$ "	$\frac{3}{8}$ "	22762	.85	22763	1.10			$\frac{7}{16}$ "	$\frac{3}{8}$ "	2 $\frac{3}{4}$ "
$\frac{5}{8}$ "	$\frac{3}{8}$ "	22764	.85	22765	1.10					
$\frac{3}{8}$ "	$\frac{1}{2}$ "	22766	.85	22767	1.10	$\frac{7}{16}$ "	$\frac{1}{2}$ "	5"	22794	2.20
$\frac{1}{2}$ "	$\frac{1}{2}$ "	22768	.85	22769	1.10					
$\frac{5}{8}$ "	$\frac{1}{2}$ "	22770	.85	22771	1.10					
$\frac{3}{4}$ "	$\frac{1}{2}$ "	22772	.85	22773	1.10					
$\frac{7}{8}$ "	$\frac{1}{2}$ "	22774	.85	22775	1.10					
1"	$\frac{1}{2}$ "	22776	.85	22777	1.10					
$\frac{3}{8}$ "	$\frac{3}{4}$ "	22778	1.10	22779	1.45					
$\frac{1}{2}$ "	$\frac{3}{4}$ "	22780	1.10	22781	1.45					
$\frac{5}{8}$ "	$\frac{3}{4}$ "	22782	1.10	22783	1.65					
$\frac{3}{4}$ "	$\frac{3}{4}$ "	22784	1.40	22787	1.90					
1"	$\frac{3}{4}$ "	22786	1.50							

ADAPTORS Use to adapt larger size sockets to smaller size shanks. "Male" is drive-square to fit drive opening of socket; "Female" is drive opening to fit drive-square of shank.

No. **22802** $\frac{1}{2}$ " Male; $\frac{3}{8}$ " Female..... **\$2.90**
 No. **22803** $\frac{1}{2}$ " Male; $\frac{1}{4}$ " Female..... **2.90**





Black & Decker

ELECTRIC
TOOL
HEADQUARTERS



SIZE 10
BALANCE REEL



GLUE POT

Electric Tool Lubricants

Research in our Engineering Department has found the most efficient lubricants for our electric tools. These lubricants are available in convenient containers of various sizes with complete instructions for their use. Our Factory Service Branches will also be glad to assist you in any maintenance, inspection or lubrication problem for good "insurance." See page 61 for addresses.

For DRILLS, TAPPERS, SCREW DRIVERS, SANDERS, POLISHERS, PORTABLE GRINDERS and PORTO-SHEARS—

No. 23638	1 lb. Can of Standard Gear Grease	\$.90
No. 23639	2 lb. Can of Standard Gear Grease	1.70
No. 32907	5 lb. Can of Standard Gear Grease	3.85

For HAMMERS—

No. 22926	4 Oz. Can Lubricating Oil	\$.35
No. 22930	1 Pound Can Lubricating Oil	.70
No. 22931	2 Pound Can Lubricating Oil	1.35
No. 32906	5 Pound Can Lubricating Oil	3.00

For VALVE REFACE HYPOID GEARS—

No. 34976	Hypoid Gear Oil—9 oz., can	\$.65
-----------	----------------------------	--------

For VIBRO-CENTRIC VALVE SEAT GRINDERS—

No. 30129	1 Pint Container of Centric Grease	\$.55
No. 30130	1 Quart Container of Centric Grease	.90
No. 30131	1 Gallon Container of Centric Grease	2.85

Size 10 Balance Reel

Use over work benches or along assembly lines for counterbalancing portable tools or fixtures weighing from 0 to 10 pounds. Adjustable cable stop is rubber cushioned and keeps the tool within reach above the work. Speeds production by reducing fatigue and handling time—also improves tool control. Prevents accidental dropping and many tool abuses. Quality built for long life and trouble-free service.

Specifications

Maximum Extension (overall) 6 foot 6 inches.
 Net Weight: 6 lbs. 6 ozs. Shipping Weight: 7 lbs. 4 ozs.
 Diameter of Spring Housing—7¼ inches.
 Adjustment Range—0 to 10 lbs. inclusive.
 Cable Stop—Adjustable by means of two screws to hold tool at convenient operating height. Rubber cushion absorbs any recoil as tool is released by operator.
 Suspension—Pivoted hanger and off-center design aids in absorbing recoil by transferring shock into circular motion.

Catalog No. 33465 Complete as shown **\$24.50**

Electric Glue Pot

CATALOG Nos. 89 and 487

FOR CONTINUOUS use where maintenance of constant working temperature is important. Thermostatic control brings the glue up to 150° Fahrenheit rapidly (best working temperature), and maintains that temperature within 5°. Nichrome heating element sealed and protected against moisture and foreign substance. Cast iron glue pot is machined to fit in the water jacket, conserving heat and reducing current consumption. Equipped with convenient carrying handle and heavy iron brush wiper.

Specifications—Capacity of glue container. 2 quarts.
 Weight: Net. 14½ lbs. Shipping. 16 lbs.

Furnished complete with nichrome heating element, iron water pot, cast-iron glue pot, 3-wire cable and plug.

Supplied for either 115 volts or 220 volts, and for either direct or alternating current.

Catalog No. 89, for alternating current (specify voltage) complete **\$27.50**

Catalog No. 487, for direct current (specify voltage) complete **\$29.50**



Black & Decker

ELECTRIC
TOOL
HEADQUARTERS

Electric Polishers

The most efficient and most popular Electric Polishers in use today are engineered by Black & Decker. Correct speed, adequate power and long productive life are the results of highest quality construction.

7" Special Electric Polisher

A LIGHT-WEIGHT Polisher for intermittent service in small shops and garages. Very easy to handle and control. Has spindle locking pin to facilitate the changing of pads and bonnets. Gears are heat treated and grease-sealed ball bearings used throughout.

Specifications

Pad Diameter7"	Weight: Net8 lbs.
Spindle Diameter	5/8"-11 thread	Shipping12 lbs.
Speed: No-load	2000 R.P.M.	
Overall Length (not including pad)7 1/8"		

Standard Equipment—Spindle locking pin; 3-conductor cable and plug; trigger switch with locking pin; 7" molded rubber pad; 7" sponge rubber pad; lambswool buffing bonnet; clamp washer; reversible side handle; "universal" motor.

Standard Voltages—115 or 220 (For other available voltages, see page 1).

Catalog No. 547 (specify voltage) **\$56.00**
Price, complete

7" Standard Electric Polisher

THIS unit contains all the features of the Automatic Electric Polisher except that it does not have the automatic feed and reservoir for liquid. The power and torque factors make the Standard Electric Polisher an ideal unit for rubbing-down operations on new paint jobs, and for cleaning all types of metal surfaces.

Specifications

Pad Diameter7"	Weight: Net9 1/4 lbs.
Spindle Diameter	5/8"-11 thread	Shipping16 lbs.
Speed: No-load	1500 R.P.M.	
Overall Length (not inc. pad)15 1/2"		

Standard Equipment—Standard Electric Polisher complete; 3-conductor cable and plug; rocker-type switch; 7" rubber cushion pad; lambswool buffing bonnet; reversible side handle; strap metal stand; "universal" motor.

Standard Voltages—115 or 220 (For other available voltages, see page 1).

Catalog No. 96 (specify voltage) **\$75.00**
Price, complete

7" Automatic Electric Polisher

THE automatic-feed principle greatly speeds up the Vitri-Glaze operation by applying the liquid directly to the car surface. A metal reservoir at the handle end holds a supply of Vitri-Glaze, and is equipped with a plunger pump (operated with the thumb) which feeds the liquid by means of a tube, through the hollow spindle of the Polisher, directly to the car surface.

Specifications

Pad Diameter7"	Weight: Net10 1/4 lbs.
Spindle Diameter	5/8"-11 thread	Shipping17 lbs.
Speed: No-load	1500 R.P.M.	
Overall Length (not inc. pad)17 1/2"		

Standard Equipment—Automatic Electric Polisher complete with reservoir, plunger pump and tube; 3-conductor cable and plug; rocker-type switch; 7" rubber cushion pad; lambswool buffing bonnet; reversible side handle; "universal" motor.

Standard Voltages—115 or 220 (For other available voltages, see page 1).

Catalog No. 97 (specify voltage) **\$90.00**
Price, complete



SPECIAL
POLISHER

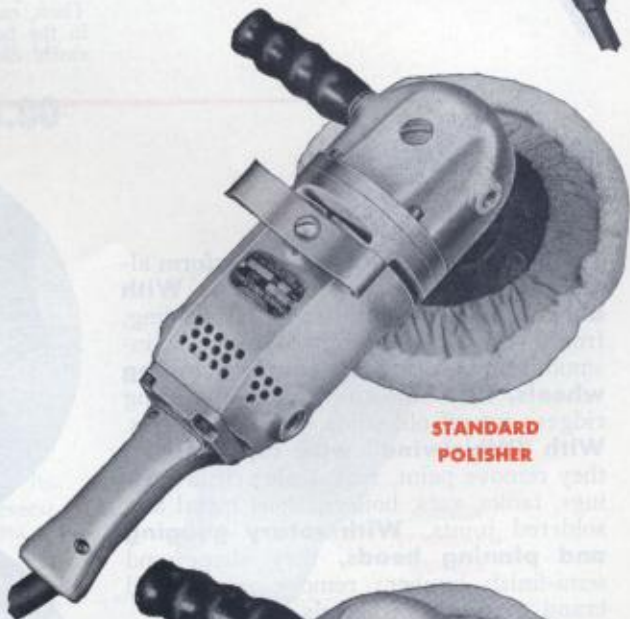

STANDARD
POLISHER



AUTOMATIC
POLISHER

See next page
for sectional drawing
of Automatic Polisher



Black & Decker

ELECTRIC
TOOL
HEADQUARTERS

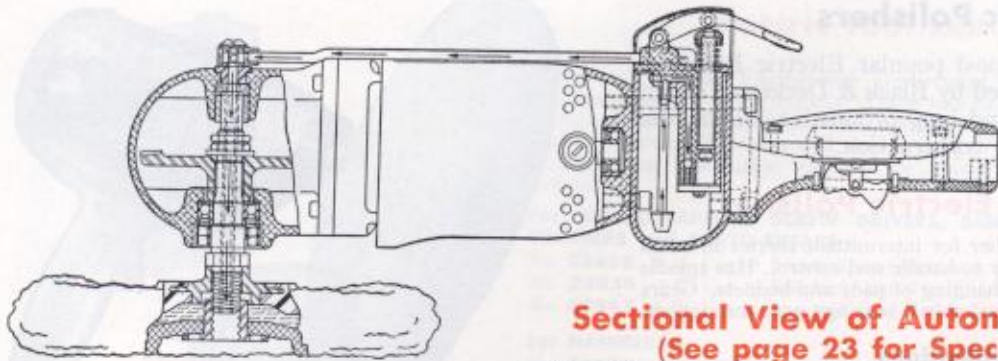

Sectional View of Automatic Polisher (See page 23 for Specifications)

After filling the reservoir with Vitri-Glaze the thumb lever is pressed to activate the pump. Several strokes are first required to fill up the pipe line. Then, each time the lever is pressed, liquid passes through the center hole in the bonnet and is sprayed directly on the work surface. Mechanism is easily cleaned by pumping clean water through the pipes.

SANDERS

Highly versatile, these tools perform almost every kind of surfacing job. **With abrasive discs,** they handle all sanding, from fast material removal to satin-smooth finishing. **With saucer grinding wheels,** they smooth welds and casting ridges; cut off old studs, bolts and rivets. **With "Whirlwind" wire cup brushes,** they remove paint, rust, scale; clean castings, tanks, vats, boilers, sheet metal and soldered joints. **With rotary gouging and planing heads,** they shape and semi-finish lumber; remove stencil and brand marks from barrels and boxes.

These Sanders are fully powered with B&D "universal" motors; perfectly balanced, with reversible side handles; and include top-quality construction features such as spiral bevel gears of heat-treated alloy and grease-sealed ball bearings.

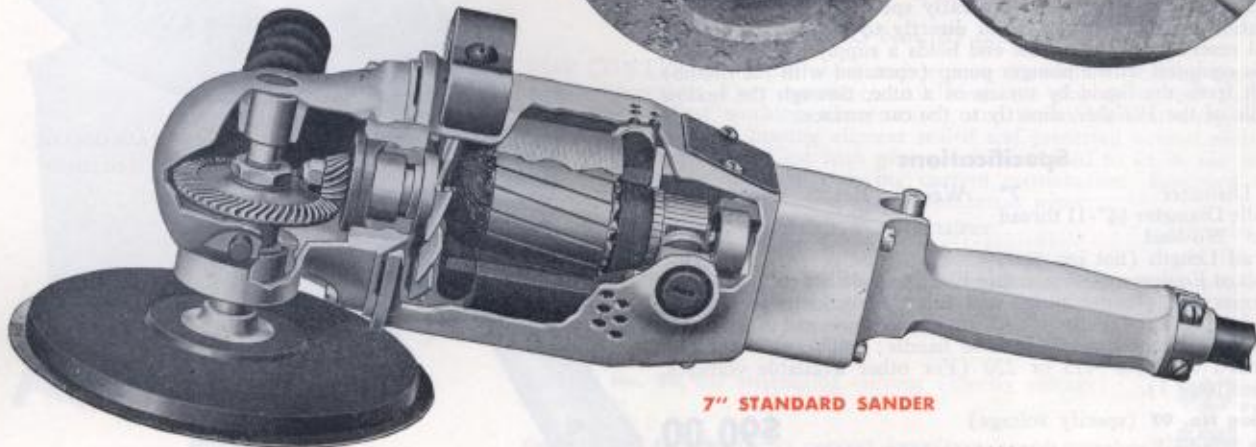
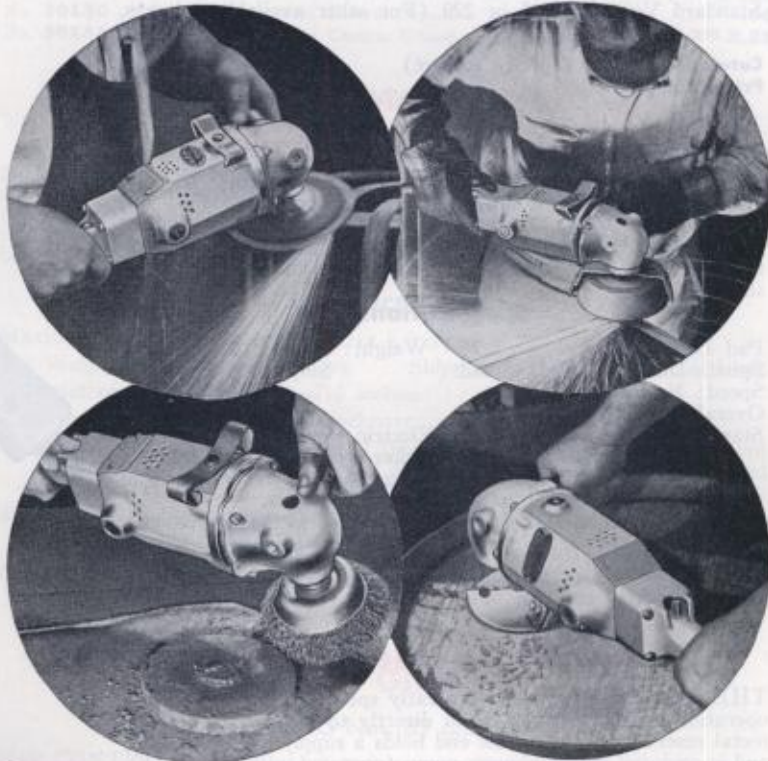

7" STANDARD SANDER



Black & Decker

ELECTRIC
TOOL
HEADQUARTERS

7" Special Ball-Bearing Sander

A LIGHT, well-balanced Sander for intermittent service on sanding, grinding, wire brushing and rubbing jobs. Switch and bearings are sealed against dust and dirt. Equipped with a spindle locking pin for changing sanding discs and other attachments. Has heat-treated gears and grease-sealed ball bearings throughout.

Specifications

Diam. of Sanding Disc 7"; Spindle, $\frac{5}{8}$ " diam.; 11 thread, right hand.
No-load Spindle Speed 3500 R.P.M.
Weight: Net 8 lbs.; Shipping 10 lbs.
Overall Length (not including pad) $7\frac{7}{8}$ "
Standard Equipment—Spindle lock; 3-conductor cable and plug; reversible side handle; 7" molded rubber pad; three 7" sanding discs (1 coarse, 1 medium, 1 fine); clamp washer; "universal" motor.
Standard Voltages—115 or 220 (For other available voltages, see page 1).

Catalog No. 91 (specify voltage)

Price, complete **\$53.00**



7-INCH
SPECIAL SANDER

7" Standard Ball-Bearing Sander

THE most popular general service unit for maintenance and production. Switch, commutator and bearings are sealed against dust and dirt. Equipped with quick-acting spindle lock for changing discs and other attachments.

Specifications

Diam. Sanding Pad, 7"; Spindle, $\frac{5}{8}$ " diam.; 11 thread, right hand.
No-load Speed . 4200 R.P.M. Overall Length (not including pad) . $17\frac{1}{2}$ "
Net Weight $12\frac{3}{4}$ lbs.; Shipping 17 lbs.
Standard Equipment—Spindle lock; 3-conductor cable and plug; reversible side handle; 7" molded rubber pad; three 7" sanding discs (1 coarse, 1 medium, 1 fine); strap metal stand; clamp washer; "universal" motor.
Standard Voltages—115 or 220 (For other available voltages, see page 1).

Catalog No. 92 (specify voltage)

Price, complete **\$73.00**

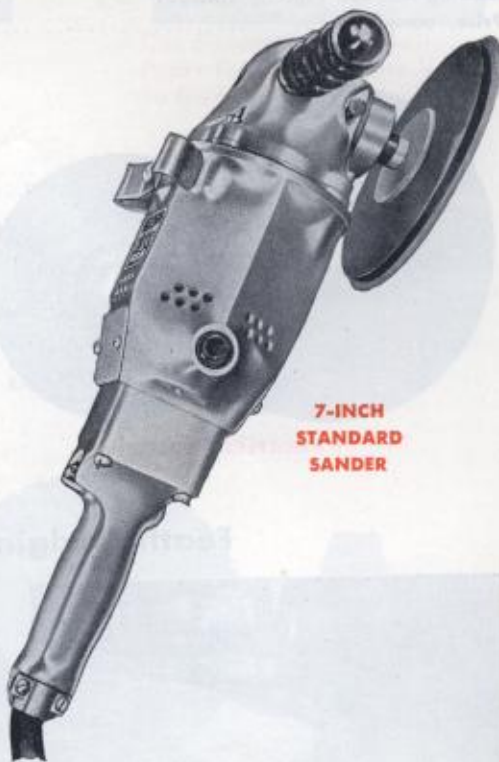

7-INCH
STANDARD
SANDER

7" Heavy-Duty Ball-Bearing Sander

EXTRA power for continuous high-speed production. All vital parts sealed against dust and dirt. Equipped with convenient spindle lock.

Diam. of Sanding Pad 7";
Spindle $\frac{5}{8}$ " diam.;
11 thread, right hand.
No-load Speed 4200 R.P.M.
Overall Length (not including
pad) 18".
Net Weight $14\frac{1}{4}$ lbs.;
Shipping 18 lbs.

Standard Equipment—Spindle lock; 3-conductor cable and plug; reversible side handle; 7" heavy duty molded rubber pad; three 7" sanding discs (1 coarse, 1 medium, 1 fine); strap metal stand; clamp washer; "universal" motor.

Standard Voltages—115 or 220 (For other available voltages, see page 1).

Catalog No. 93 (specify voltage)

Price, complete **\$82.00**



7-INCH
HEAVY-DUTY SANDER



Black & Decker

ELECTRIC
TOOL
HEADQUARTERS

9-inch Heavy-Duty Sander

(Also Perfect for Angle Grinding)

POWERED for heavy-duty production, faster schedules, more output per tool. Switch, commutator and bearings sealed against dust and dirt. Equipped with spindle-lock. Recommended for wire cup brushes, saucer wheels and planer heads.



Diam. of Sanding Pad 9"; Spindle 5/8" diam.; 11 thread, right hand.
No-load Spindle Speed 4000 R.P.M.*
Weight: Net 18 3/4 lbs.; Shipping 25 lbs.
Overall Length (not including pad) 19 1/2"
Standard Equipment—Spindle lock; 5" molded rubber pad; 6 3/4" Kooflex pad;
8 7/8" Kooflex pad; clamp washer; three 9 1/8" abrasive discs (1 coarse, 1 medium,
1 fine); reversible side handle; strap metal stand; suspension eye-bolt; 3-conductor cable and plug (3rd wire for grounding); "universal" motor.

Standard Voltages—115 or 220 (For other available voltages, see page 1).

*Optional speed of 5000 R.P.M. available at no extra cost.

Catalog No. 433 (specify voltage)

Price, complete

\$98.00

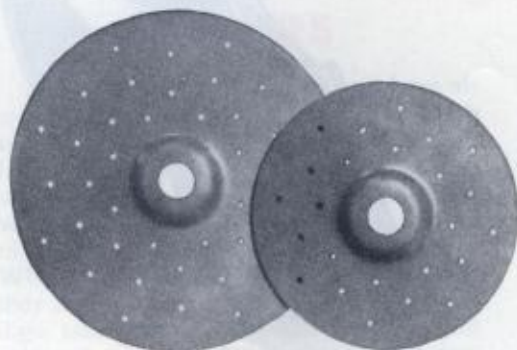

KOOFLEX PADS

"Kooflex" Backing Pads

These light-weight plastic-bonded backing discs provide greater flexibility and very cool operation on sanding applications. Use with No. 33489 5" Molded Rubber Pad as illustrated above on the 9" Heavy-Duty Sander which includes Kooflex Pads as standard equipment. For maximum flexibility use one Kooflex Pad with corresponding size Abrasive Disc (i.e. 6 3/4" Kooflex Pad with 7" Sanding Disc). For "feathering" finish use No. 31000 6 3/4" Kooflex Pad with 9 1/8" Abrasive Disc. For more rigid backing use both sizes of Kooflex Pads with 9 1/8" Abrasive Disc.

No. 31000 6 3/4" "Kooflex" Backing Pad **\$1.65**
No. 31001 8 7/8" "Kooflex" Backing Pad **2.25**

The No. 33257 Clamp Washer, now standard equipment on all sanders (also furnished with No. 33489 5" Molded Rubber Pad) will properly hold these Kooflex Pads in position. No special clamp washer is needed.

For former type 5" Rubber Backing Pads without threads in hub use inside threaded clamp washers as follows:

No. 31003 Special Clamp Washer for one Kooflex Pad **\$.50**
No. 31004 Clamp Washer to be used when both Kooflex Pads are used... **.55**

Feather Edging Attachment for 7" Sanders



The new modern way to feather-edge. Uses inexpensive and flexible, cloth-backed discs which are held by a quick-acting twist-lock plunger. This attachment cuts out practically all hand sanding and feather-edges old finishes in one-half to one-fifth the time of former methods. Sanding disc is driven by friction between itself and a felt pad. When pressure on the sanding disc becomes too great, a slipping action prevents deep scratch lines. A fibre pad backs up the felt pad to give correct degree of flexibility.

No. 33493 Feather-Edging Attachment as illustrated with two coarse, two medium and two fine Sanding Discs **\$7.50**

Replacement Items

No. 34342 "Twist-Lock" Plunger **\$1.10**
No. 33495 Pkg. of 6 Abrasive Discs* (coarse), 80 grit, open **1.45**
No. 33496 Pkg. of 6 Abrasive Discs† (medium), 150 grit, open **1.30**
No. 33497 Pkg. of 6 Abrasive Discs† (fine), 220 grit, open **1.30**
No. 33998 Felt Pad with Fibre Backing Pad **1.75**

* "D" back. † "C" back.



Black & Decker

ELECTRIC
TOOL
HEADQUARTERS

Sander and Polisher Attachments and Supplies

VITRI-GLAZE—For use with Power Polishers

VITRI-GLAZE is supplied in two grades—Standard-Duty and Heavy-Duty. "Standard-Duty" should be used always if the car is new or if the surface does not have an excessive coating of road scum. Under normal conditions Heavy-Duty Vitri-Glaze should not have to be used; but in some cases, however, the road film will be so thick that to remove it with "Standard-Duty" would take several applications. In these cases use Heavy-Duty Vitri-Glaze which contains stronger cleaning properties and will remove the foreign material with one application.

- | | |
|---|--------|
| No. 33363 Standard-Duty Vitri-Glaze | |
| 1-gallon container, per gallon | \$2.75 |
| Case of six 1-gallon containers, per gallon | 2.45 |
| No. 33364 Heavy-Duty Vitri-Glaze | |
| 1-gallon container, per gallon | \$2.75 |
| Case of six 1-gallon containers, per gallon | 2.45 |



Car Surface Before
Vitri-Glaze Applied



Car Surface During Vitri-
Glaze Process — Dead
Pigments Removed



Car Surface After Vitri-Glaze—
Peaks Folded Over Into Valleys
To Give Smooth, Glazed Surface

Polishing Bonnets and Pads

- | | |
|---|--------|
| No. 13087 Lambswool Bonnet with hood and drawstring
(Use with Molded Rubber Pad) | \$2.15 |
| No. 22176 Lambswool Bonnet with hood and drawstring
(Use with Cushion Pad alone, or with Molded Rubber Pad
and Sponge Rubber Pad) | 2.70 |
| No. 13086 Lambswool Pad | |
| Individually boxed, each | 1.55 |
| Packed in carton of six pads, each | 1.40 |
| No. 22174 7" Sponge Rubber Pad | 1.40 |

All of above items are used with Molded Rubber Pads and Clamp Washers.



LAMBSWOOL BONNET

Cushion Pad for Polishers

A superior cushioning pad for use with Lambswool Bonnets. Threads directly on Polisher spindle. Note serrations which give extra flexibility for getting in tight corners to do a complete polishing job. A Clamp Washer is supplied with each Cushion Pad.

- | | |
|---|--------|
| No. 33982 Cushion Pad with Clamp Washer | \$7.00 |
| No. 33257 Replacement Clamp Washer | .60 |



CUSHION PAD

Rubbing Pads

For rubbing down orange peel in lacquer finishes, etc. Attaches direct to flexible pad of Polisher or Sander.

- | | |
|---|--------|
| No. 20619 7" Pile Fabric Rubbing Pad | \$1.80 |
| No. 21207 9 1/4" Pile Fabric Rubbing Pad | 2.50 |
| No. 10661 Felt Rubbing Pad for 7" Polisher or 7" Sander | 1.95 |
| No. 10709 Felt Rubbing Pad for 9" Sander | 2.75 |

Power Wax

Although the Vitri-Glaze Method does not require the use of wax, we have wax available for those who insist that it be used. This Power-Wax is made for use with power polishers.

- | | |
|---|--------|
| No. 31463 1-quart can of Power-Wax, per quart | \$1.50 |
| Case of six 1-quart cans, per quart | 1.25 |

Power Rubbing Compound

For those cars that have been newly repainted. Power Rubbing Compound used with a power polisher equipped with a Pile Fabric Pad will quickly remove "orange peel" and spray pits. Rubbing Compound contains abrasives and should be used carefully to protect the surface.

- | | |
|---|--------|
| No. 31459 1-gallon container of Power Rubbing Compound,
per gallon | \$2.25 |
| Case of six 1-gallon containers, per gallon | 1.95 |

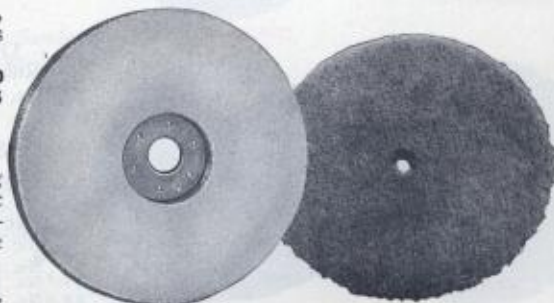

FELT

PILE FABRIC

RUBBING PADS



Black & Decker

ELECTRIC
TOOL
HEADQUARTERS

SANDER AND POLISHER ATTACHMENTS

Sanding Discs



SANDING
DISCS

Grade	7-Inch Sanding Discs		9 1/8-Inch Sanding Discs	
	Cat. No.	Price Each	Cat. No.	Price Each
16	17815	\$0.58	26458	\$0.77
24	9990	.45	10719	.60
36	9991	.44	10720	.59
50	9992	.42	12153	.55
60	18489	.40	18493	.53
80	10485	.38	10721	.50
100	12145	.38	12149	.50
120	12146	.38	12150	.50
150	12147	.38	12151	.50
180	12148	.38	12152	.50
Open Grain				
16	15134	.58	15137	.77
24	15135	.45	15138	.60
36	15136	.44	15139	.59
50	12011	.42	12131	.55
60	18491	.40	18495	.53
80	12012	.38	12132	.50
120	12013	.38	12133	.50

All discs packed 25 to a box.

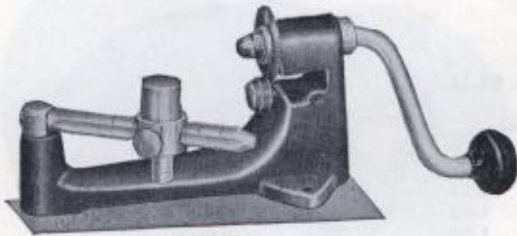

DISC TRIMMER

Abrasive Disc Trimmer

FOR complete use of abrasive discs, this Disc Trimmer cuts them down to smaller sizes as the outer edges are worn out. Adjustable center-hole pilot on calibrated swinging arm; cutting wheel mounted on one-piece spindle and crank; base casting is screwed to bench. Takes discs of 9 1/8" maximum diameter and either 7/8" or 1/2" center-hole; trims down to 3" diameter.

No. 21808 Abrasive Disc Trimmer, Type B, complete \$9.50
No. 21753 Replacement Cutter45

Improved Flexible Backing Pads

MOLDED Rubber Pads listed below have an inside-threaded hub which screws directly on the spindle of all Sanders and Polishers. This hub also has an additional larger inside thread to take an outside-thread clamp washer—one only being required to hold all kinds of discs, pads, bonnets, etc. This eliminates the variety of clamp washers which were formerly needed to handle pads of various thicknesses.

No. 33262 7" Standard Molded Rubber Pad with No. 33257 Clamp Washer \$3.25
No. 33488 7" Heavy-Duty Molded Rubber Pad with No. 33257 Clamp Washer 3.75
No. 33487 9" Molded Rubber Pad with No. 33257 Clamp Washer 6.00
No. 33489 5" Molded Rubber Pad with No. 33257 Clamp Washer 3.50

Replacement Clamp Washer

Outside-threaded, screws directly into new 5", 7" and 9" Molded Rubber Pads listed above.

No. 33257 Clamp Washer \$.60

Clamp Washers (Former Type, Inside-Threaded)

Screws directly onto spindle, through hub of former type Molded Rubber Pads (Nos. 17687, 18329, 18330 and 22489—no longer catalogued). Use these washers until pads become worn out and are replaced with the new, improved type listed above.

No. 10279 Clamp Washer for Sanding Discs, and Lambswool Bonnet \$.45
No. 22191 Clamp Washer for Lambswool Bonnet with Sponge Rubber Pad50
No. 31003 Clamp Washer for Sanding Disc and one Kooflex Pad50
No. 31004 Clamp Washer for Sanding Disc with both Kooflex Pads55



MOLDED RUBBER PAD



No. 33257
CLAMP WASHER

SANDER AND POLISHER ATTACHMENTS

Wire Cup Brushes

Made in our own plant, for use on all Portable Electric Sanders. Well built of finest quality wire to give long service on the toughest kinds of cleaning operations. Use these Wire Cup Brushes for removing rust and scale from all metal surfaces; for cleaning tanks and boat hulls; for taking off old paint; for cleaning castings and structural metal. The hub of the Wire Cup Brush is fitted with a $\frac{5}{8}$ "-11 thread bushing, which threads on the Sander spindle.

- No. 18056 4" Wire Cup Brush (.020"-crimped) for 7" Special and 7" Standard Sander... **\$2.90**
- No. 24353 5" Wire Cup Brush (.020"-crimped) for 7" Heavy-Duty Sander **3.50**
- No. 12398 6" Wire Cup Brush (.020"-crimped) for 9" Heavy-Duty Sander **4.05**

Saucer Grinding Wheel

For some metal grinding applications, the Sander equipped with a Saucer Grinding Wheel does smoother and faster work than a Portable Grinder. Saucer Wheels have $\frac{5}{8}$ "-11 thread bushing to fit spindle direct.

- No. 24050 4" Saucer Grinding Wheel (for 7" Standard Sander) ... **\$ 5.35**
- No. 23444 5" Saucer Grinding Wheel (for 7" Heavy-Duty Sander) **7.50**
- No. 18039 6" Saucer Grinding Wheel (for 9" Heavy-Duty Sander) **10.00**
- No. 17329 Skirt Wheel Guard (for Heavy-Duty Sanders) **7.25**

Cup Grinding Wheel

For smoothing welds and other metal surfaces. Use No. 10711 Spindle Extension to attach to Sander.

- No. 10663 4" Cup Grinding Wheel **\$2.30**
- No. 10711 Spindle Extension **3.15**

Rotary Planer Heads

Perform many wood surfacing and shaping operations formerly done with jack-plane and adz. Two types of planer head are supplied; one with rounded surface for deep gouging, the other with flat face for surfacing and semi-finishing. These heads are interchangeable on the spindle of the 7" Heavy-Duty and 9" Heavy-Duty Sanders.

- No. 14734 5" Gouging Planer Head, complete with blades **\$14.50**
- No. 14735 5" Surfacing Planer Head, complete with blades **14.50**
- No. 14733 Replacement Blade (same for either head), Set of 3.... **2.10**

Miscellaneous Attachments

- Suspension Eye-Bolt** for Standard and Heavy-Duty Sanders; and Standard Polishers. No. 2473, price each **\$.35**
- Strap-metal Stand**, to support Sanders and Polishers when not in use. Fits Standard and Heavy-Duty models. No. 22411, price **.35**
- Sander Spindle Adapter**—A bushing, threaded inside and outside to adapt Black & Decker Sander pads and attachments to Sanders with $\frac{3}{8}$ " diameter threaded Spindles. No. 30571, price **1.65**
- Spanner Wrench**—For use in tightening clamp washers on Sanders and Polishers. No. 22231 **.95**

$\frac{1}{4}$ " Chuck for Drilling with Sanders and Polishers

- Useful for intermittent drilling. Works best with the 7" Special Sander or Polisher as their design permits comfortable handling on drilling jobs.
- No. 34272 $\frac{1}{4}$ " Jacobs (7BTY) Chuck **\$6.00**

Lubricant for Sanders and Polishers

The spiral bevel gears in all Black & Decker Sanders and Polishers now require the same improved lubricant that is recommended for Drills and other portable Tools. This lubricant is available in convenient containers.

- No. 23638 1-lb. container of Standard Gear Grease **\$.90**
- No. 23639 2-lb. container of Standard Gear Grease **1.70**
- No. 32907 5-lb. container of Standard Gear Grease **3.85**

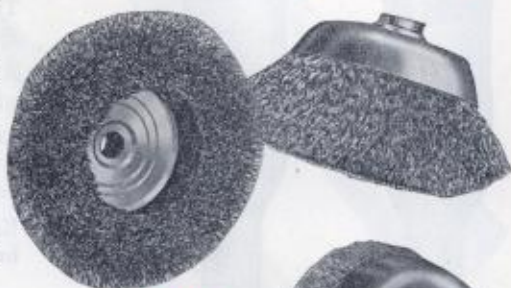

WIRE CUP BRUSHES



SKIRT GUARD



SAUCER WHEEL



CUP WHEEL



SPINDLE EXTENSION



ROTARY PLANER HEADS





Black & Decker

ELECTRIC
TOOL
HEADQUARTERS

NEW No. 8 Die Grinder



NO. 8 DIE GRINDER

Many years of engineering development are behind this completely new tool, which includes every necessary feature to contribute to precision, portable grinding. These important advantages include:

- (1) A new, powerful Black & Decker motor; the smallest in any B&D tool. This permits a net weight of only 2 $\frac{1}{8}$ lbs. and a main housing diameter of only 2 $\frac{1}{8}$ " for convenient and accurate handling.
- (2) A high no-load speed of 30,000 R.P.M. giving 9500 surface feet per minute with a 1 $\frac{1}{4}$ " high-speed bonded wheel.
- (3) Latest-design collet chuck takes mounted points and stones with $\frac{1}{4}$ " shanks. As extra equipment, a split sleeve permits reducing the collet opening to take $\frac{3}{8}$ " shanks.
- (4) Extended spindle housing permits gripping the tool close to the grinding stone for delicate and careful grinding.

Specifications

Maximum Wheel Diameter	1 $\frac{1}{4}$ "
No-load Spindle Speed	30,000 R.P.M.
Weight	Net 2 $\frac{1}{8}$ lbs.; Shipping
Overall Length	11 $\frac{1}{2}$ "
Standard Equipment—3-conductor cable and plug; $\frac{1}{4}$ " chuck; two double end wrenches; toggle switch and "universal" motor.	
Standard Voltages—115 or 220 (For other available voltages, see page 1).	

Catalog No. 577 (specify voltage)

\$85.00

Price, complete

No. 21955 Split Sleeve for reducing collet opening in No. 8 Die Grinder to $\frac{3}{8}$ "

\$1.40

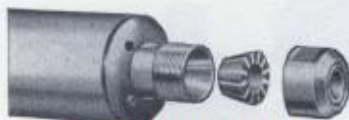

JACOBS RUBBER-FLEX
COLLET CHUCK

3-Inch Die Grinder



3-INCH
DIE GRINDER

Maximum Wheel Size*	3" x $\frac{1}{2}$ " x $\frac{3}{8}$ "
No-load Speed	16,000 R.P.M.
Weight: Net	7 lbs.; Shipping
Overall Length	17 $\frac{3}{4}$ "

Catalog No. 499 with extended switch handle

\$67.00

Price, complete (specify voltage)

Standard Equipment—3-wire cable and plug; No. 24187 $\frac{1}{4}$ " Chuck with No. 21955 Reducing Sleeve; two No. 20285 Wrenches; "universal" motor.

*No wheels are supplied with any Die Grinders. Caution: Use only with high-speed bonded wheels. Ask your jobber about wheels and burrs for use with these units.

Standard Voltages—115 or 220 (For other available voltages, see page 1). Replacement and Extra Equipment for 3" Die and 3" Portable Grinders.

No. 24317 3" High-speed bonded Grinding Wheel	\$1.75
No. 31457 3" Wheel Guard Assembly, complete	4.00
No. 31456 Clamp Nut85
No. 24187 $\frac{1}{4}$ " S. A. Chuck with $\frac{3}{8}$ " Reducing Sleeve	6.50
No. 21955 $\frac{3}{8}$ " Reducing Sleeve Only, for No. 24187 Chuck	1.40



Black & Decker

ELECTRIC
TOOL
HEADQUARTERS

Portable Electric Grinders

PORTABLE GRINDERS have splined gear mountings, steel inserts for bearings and welded steel wheel guards. Full size ball bearings, set at extreme ends of wheel spindle, absorb all side thrust and insure long life. Armature shaft also mounted on ball bearings.

Completely enclosed commutator and switch compartments protect these parts from abrasive dust.

Improved ventilating system forces air straight through ample slots, which prevent clogging and accumulation of dirt.

Shaped grips prevent tool turning in operator's hand. Adjustable wheel guards can be turned to any desired position.

Applications—Grinding, wire brushing, buffing and polishing all types of metal surfaces, where the grinder must be taken to the work. Removing rust, scale, paint, etc. Grinding or cutting off rivets, bolts, pins, studs, etc. Smoothing welded surfaces.

3" Portable Grinder

Wheel Size	3" x 1/2" x 3/8"
No-load Speed	16,000 R.P.M.
Weight: Net75 lbs.; Shipping.....
Overall Length	11 1/2 lbs. 16 3/4"

Catalog No. 395 with extended switch handle

Price, complete (specify voltage) **\$67.00**

Standard Equipment—3-wire cable and plug; No. 24317 3" high-speed wheel; No. 31456 Clamp Nut; No. 31457 Wheel Guard; two No. 20285 Wrenches; "universal" motor.

Standard Voltages—115 or 220 (For other available voltages, see page 1). Replacement and Extra Equipment for 3" Die and 3" Portable Grinders.

No. 24317	3" High-speed bonded Grinding Wheel	\$1.75
No. 31457	3" Wheel Guard Assembly, complete	4.00
No. 31456	Clamp Nut85
No. 24187	1/4" S. A. Chuck with 3/8" Reducing Sleeve	6.50
No. 21955	1/8" Reducing Sleeve Only, for No. 24187 Chuck	1.40

5" Portable Grinder

CATALOG No. 60

Wheel size	5" x 3/4" x 1/2"
No-load speed	4500 R.P.M.
Weight: Net	15 1/2 lbs.; Shipping.....
Overall Length	21 lbs. 23 1/8"

Standard Equipment—3-conductor cable and plug; plunger switch; grip end handle; adjustable steel wheel guard and one grinding wheel; "universal" motor.

Standard Voltages—115 or 220 (For other available voltages, see page 1).

Catalog No. 60 (specify voltage)

Price, complete **\$88.00**

6" Portable Grinder

CATALOG No. 61

Wheel size	6" x 1" x 5/8"
No-load speed	3800 R.P.M.
Weight: Net	20 lbs.; Shipping.....
Overall Length	26 lbs. 25"

Standard Equipment—3-conductor cable and plug; plunger switch; grip end handle; adjustable steel wheel guard and one grinding wheel; "universal" motor.

Catalog No. 61 (specify voltage)

Price, complete **\$100.00**

Standard Voltages—115 or 220 (For other available voltages, see page 1). Wheel Rotation—Counter-Clockwise, facing wheel-end.

See Pages 35 and 36 for Wheels and Wire Brushes.





Black & Decker

ELECTRIC
TOOL
HEADQUARTERS

NEW 6" Heavy-Duty Ball-Bearing Bench Grinder

THIS IS a full $\frac{1}{3}$ Horsepower Grinder—ball-bearing equipped and quality built for Heavy-Duty service in grinding, tool sharpening, wire brushing and buffing. Steel Wheel Guards are mounted on the motor housing and will accommodate a 2-section Wire Wheel Brush without removing the end covers. Tool Rests are locked in base grooves with wing nuts and are adjustable for wheel wear.

Spot several of these popular-price Grinders at strategic points in your shop. Keep them within easy reach of your workers to save steps and speed up dozens of Bench Grinder jobs.



Specifications

- Wheel size 6" diam. x $\frac{3}{4}$ " face x $\frac{1}{2}$ " hole.
- Motor—Not "universal." Supplied for all standard A.C. single-phase voltages and cycles only. Not available for Direct Current.
- Motor rating $\frac{1}{3}$ H.P. (except 25 cycles)
- Weight: Net 27 lbs.
- Shipping 30 lbs.
- Overall Spindle Length 12"
- Overall height $9\frac{3}{8}$ "
- Height to center-line of spindle $5\frac{3}{8}$ "
- Standard Equipment—3-conductor cable and plug; toggle switch in base; 4-rubber feet, 2 wheel guards, 2 tool rests, 2 grinding wheels (1 Medium, 1 Fine)

Current Specifications and Catalog Numbers

Phase	Cycles	R.P.M.	Cat. No.	Available Voltages*
1	60	3600	587	115 or 220
	50	3000	587	115 or 220
	25	1500	588	115 or 220

* On Special Order only; single phase; 50-60 cycle; 125 or 240 volts. Give complete current characteristics when ordering.

Price, complete (specify voltage, phase and cycle) **\$59.50**

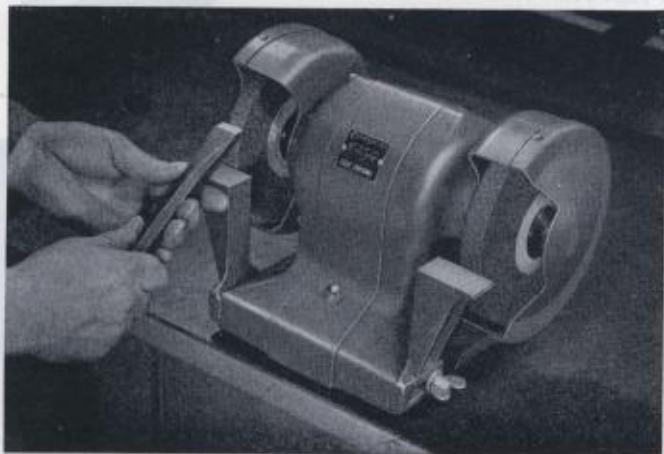

Bench Grinder Accessories

	Page
PEDESTALS	33
EYE SHIELDS - Not Illuminated	33
EYE SHIELDS - Illuminated	34
GRINDING WHEELS	35
WHEEL DRESSERS	35
COTTON BUFFS	35
LAMP - Adjustable "Goose-Neck"	35
WIRE WHEEL BRUSHES	36



Black & Decker

ELECTRIC
TOOL
HEADQUARTERS

8" Heavy-Duty Ball-Bearing Bench Grinder

This superbly engineered 8-Inch Heavy-Duty Bench Grinder is powered by a full 3/4-horsepower motor, built by Black & Decker for heavy duty bench grinder operation. Other important features of this unit are:

Aluminum die-cast housings for smooth streamlined finish and full grinding clearance.

2-pole push-button switch, recessed for protection but easily accessible.

Enclosed steel wheel guards meet all safety requirements.

U-shaped tool rests give full support, are adjusted for wheel wear and are perforated to prevent accumulation of dust and metal.

Wheel guards equipped with adjustable spark shields and will take standard 3-section wire wheel brush without changing guard.

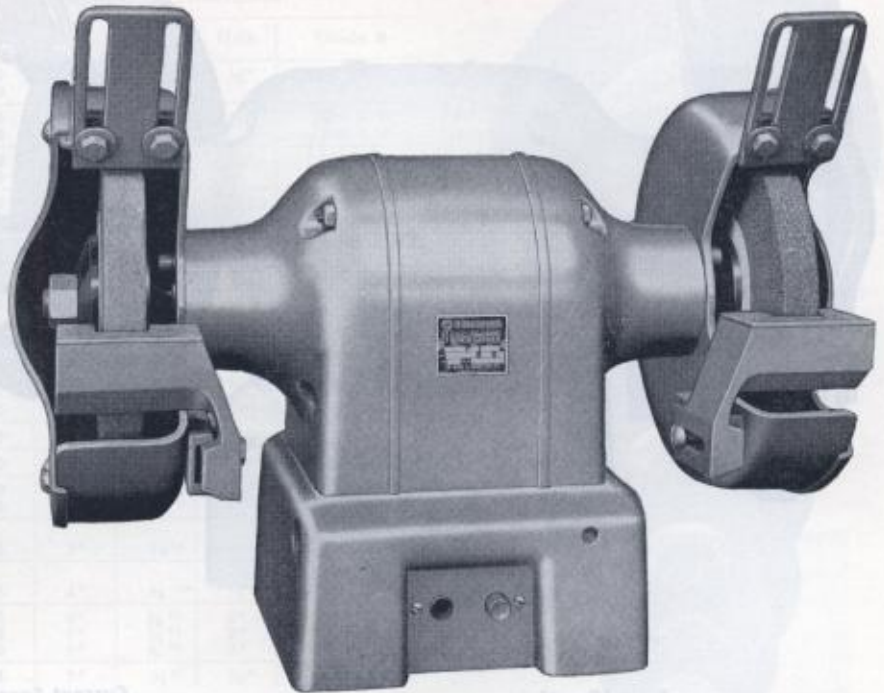

Specifications

- Wheel size: 8" diameter x 7/8" face x 5/8" hole.
- Motor: Not "universal," not available for direct current. See table of available currents at right.
- Motor Rating: 3/4 H.P.
- Weight: Net 71 lbs.
- Shipping 75 lbs.
- Overall Spindle Length 18 1/4"
- Height: Total 14"
- to center-line of spindle 7 13/16"
- Standard Equipment—Lead wires for permanent connection; push-button switch in base; rubber feet; two enclosed wheel guards with tool rests and spark shields; two 8" grinding wheels, one medium, one fine.

Current Specifications and Catalog Numbers

Phase	Cycles	R.P.M.	Cat. No.	Available Voltages
1	60	3600	74	115 or 220
	50	3000	74	115 or 220
3*	60	3600	76	220/440
	50	3000	76	220/440

* Three-phase voltages shown in combination are reconnectable for either voltage.

Give complete current characteristics of your power supply when ordering.

Price, complete for available currents.....\$105.00



PEDESTALS for 6", 8" and 10" Bench Grinders

Supports grinder at convenient operating height. Water pot is detachable.

No. 30700 Pedestal for 6" and 8" Bench Grinders \$31.00

No. 30835 Pedestal for 10" Bench Grinder \$40.00

Note: Bench Grinders have tapped holes in base for use in mounting them on pedestals. (6" and 8" Grinders—1/4"-28 tapped) (10" Grinder—5/16"-24 tapped)



Shatter-proof Eye-Shields

For 6", 8" and 10" BENCH GRINDERS. Shields are bolted to wheel guards through holes already positioned on Bench Grinders. Brackets are quickly adjustable to suit operator.

No. 34575 One 3 1/4" x 5 1/4" Eye-Shield, complete with glass, brackets and bolts \$3.00

No. 34576 One 3 1/4" x 5 1/4" Replacement Shatter-proof glass \$1.10

See Next Page for ILLUMINATED Eye Shields



Black & Decker

ELECTRIC
TOOL
HEADQUARTERS

10" Ball-Bearing Bench Grinder

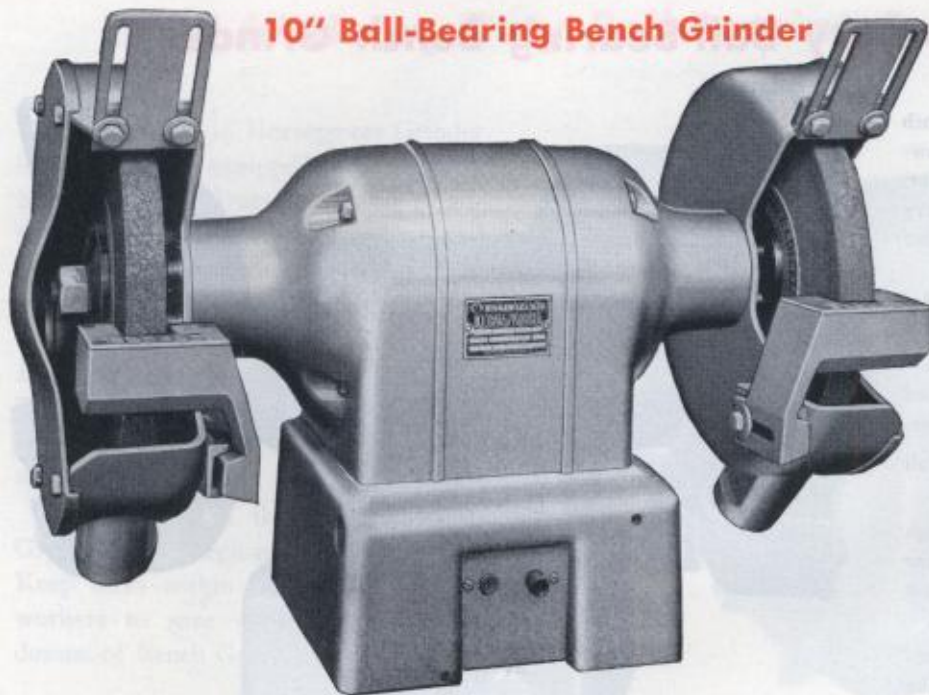

A FULL one-horsepower Bench Grinder powered by a heavy-duty Black & Decker constant-speed motor designed for finest tool dressing, grinding, wire brushing, burnishing and buffing. Die-cast aluminum housings are smooth, easy to clean and give maximum wheel clearance. Other important features:

Strong steel wheel guards, enclosed for full safety, with removable end plates.

Guards are wide enough for a 4-section wire wheel without changing guard.

Spark shields adjustable for wheel wear.

U-shaped tool rests, adjustable for wheel wear and perforated to prevent piling up of dust.

Guards equipped with exhaust outlets for connection to exhaust ducts or dust-collecting system.

2-pole push button protected switch, recessed for safety but easy to use.

Machined socket in base for accurate mounting of special attachments, such as twist drill dressing arm.

Specifications

Wheel size: 10" diam. x 1" face x 3/4" hole.
Motor: Not "universal," not available for direct current. See table at right for all available voltages, phases and cycles.
Motor Rating: 1 H.P. (except 25 cy. which is 3/4 H.P.)
Weight: Net 88 lbs.
Shipping 116 lbs.
Overall Spindle Length 22 3/4"
Height: Total 16 1/4"
To C/L Spindle 9 1/4"
Standard Equipment—Lead wires for permanent connection; push-button switch in base; two wheel guards; two grinding wheels, one coarse, one medium.

Current Specifications and Catalog Numbers

Phase	Cycle	R.P.M.	Cat. No.	Available Voltages
1	60	1800	83	115 or 220
	50	1500	83	115 or 220
	25	1500	78	115 or 220
3*	60	1800	85	220/440*
	50	1500	85	220/440*
Available only on special order:				
1	50/60	1500-1800	83	125, 240
3*	50/60	1500-1800	85	550
	25	1500	79	220/440*

* 3-phase voltages in combination are reconnectable for either voltage. Give complete characteristics of your current when ordering.

Price, complete for available currents..... **\$148.00**

Illuminated Eye Shields

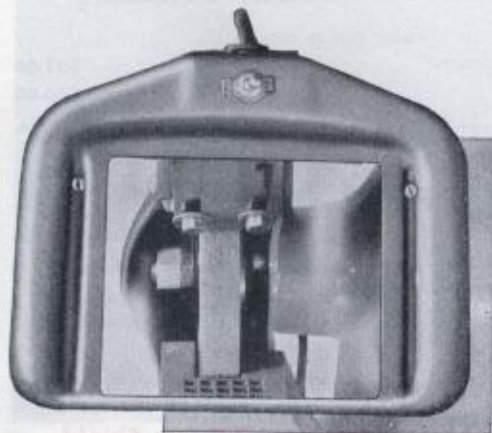

Illuminated Eye Shields have been developed for use with all 6", 8" and 10" Bench Grinders. Shields are furnished with adjustable brackets and bolts for attachment to the Wheel Guards. Glass is shatter proof and work is illuminated from both sides of the eye shield. If the grinder is of voltage other than 115, eye shields may be purchased with individual cords, plugs and switches for use in separate 115 volt receptacles.

- No. 30050 An Assembly of a pair of 115 volt illuminated Eye Shields, to be connected to and operated by the 115 volt Bench Grinder Switch **\$21.00**
- No. 30142 An Assembly of a pair of 115 volt illuminated Eye Shields, with cord, plug and switch, operated independently of the Bench Grinder switch **22.00**
- No. 30144 An Assembly of a single 115 volt illuminated Eye Shield, with cord, plug and switch, operated independently of the Bench Grinder switch **11.50**
- No. 23641 5" x 6" Replacement Shatter-proof Glass **1.10**



Black & Decker

ELECTRIC
TOOL
HEADQUARTERS

Grinding Wheels

Unit	Cat. No.	Price	Description			
			Diam.	Face	Hole	Grade #
6" Junior, 6" Standard Bench Grinder (A)	18124	\$2.60	6"	3/8"	3/8"	A60 N V
	18125	2.60				A36 R V
6" H.-D. Bench Grinder (H, K, L, and M)	15315	2.90	6"	3/4"	3/8"	A36 R V
	15314	2.90				A60 N V
8" Bench Grinder (Types F and G)	18061	5.50	8"	3/8"	3/8"	A36 N6V
	18062	5.50				A60 L6V
10" Bench Grinder (Types B, C and D)	10275	8.50	10"	1"	3/4"	A46 N6V
	10274	8.50				A23 Q6V
Portable Grinders and Die Grinders	20330	1.40	2"	1/2"	1/2"	A36 T B
	20329	1.50	2 1/2"	1/2"	1/2"	A30 S B
	24317	1.75	3"	1/2"	1/2"	A36 T B
4" Portable Grinder	6772	1.80	4"	3/4"	1/2"	A36 R V
5" Portable Grinder	3042	2.60	5"	3/4"	1/2"	A36 R V
6" Portable Grinder	3148	3.40	6"	1"	3/8"	A36 R V
7" Special Sander	10663	2.30	4"	3/4"***	3/8"	A36 Q V
7" Standard Sander	24050	5.35	4"	1"††	3/8"	A16 Q B
7" H.-D. Sander	23444	7.50	5"	1 1/4"††	3/8"	A15 Q B
9" H.-D. Sander	18039	10.00	6"	1 1/4"††	3/8"	A16 Q B
Super-Service Refacer (Types MW, NW, NWA, NWB)	19897†	3.30	4"	1 1/2"***	5/8"	C80 N5V
	33056	3.35	4"	3/2"***	3/8"	C80 N5V
Super-Service Refacer (Types P-PC-PCB)	34131	5.25	5"	3/2"***	3/8"	C80 L5V
Valve Stem and Rocker Arm Attachment	20939	2.65	4"	3/4"***	1/2"	A36 J4V
No. 6 Univ. Valve and Tool Grinder	32944	3.65	6"	3/4"†	2"	C60 N5V
	31429	3.65	6"	3/4"†	2"	A46 N5V
	32822	5.00	6"	3/4"†	2"	C80 N5V
3/4" Drill	21463	.95	3"	1/2"	1/2"	A46 M V

* Offset. † Recessed. ** Cup. †† Saucer—11 thread bushing. ‡ Beveled.
Based on Grinding Wheel Manufacturers' Association Nomenclature.



GRINDING WHEELS

Grinding Wheel Dressers

TWO TYPES of Wheel Dressers are available for truing and cleaning Bench Grinder Wheels. The cutter type dresses the wheel quickly for fast grinding; the diamond type produces a very accurate, smooth face for finish-grinding.

No. 19115	Cutter-type Dresser (with spare cutter set)	\$1.55
No. 19983	Replacement Cutter set for above	.20
No. 21961	Diamond Wheel Dresser, complete with diamond	6.75
No. 5574	Diamond and Nib for No. 21961 Dresser	3.85

Cotton Buffs

USED ON Portable or Bench Grinders for general purpose buffing, polishing, coloring, cutting and finishing. Mounted directly on wheel spindle. Available in full disc, loose type and in a harder, spiral stitched, pieced-type.

Full-disc. Loose Buffs—50-ply, Grade L.		
No. 26870	4" x 3/8" x 1/2"; Stitched 2 Rows	\$1.05
No. 26871	6 x 3/8" x 1/2"; Stitched 2 Rows	1.65
No. 26872	8" x 3/8" x 3/8"; Stitched 2 Rows	2.75
No. 26873	10" x 3/8" x 3/4"; Stitched 3 Rows	4.00
Pieced-type, Narrow Buffs, Grade SB.		
No. 26874	6" x 1/4" x 1/2"; 3/8" Spiral Stitched	.85
No. 26875	8" x 1/4" x 3/8"; 3/8" Spiral Stitched	1.25
No. 26876	10" x 1/4" x 3/4"; 3/8" Spiral Stitched	1.70

1/2" Chuck for 6" Bench Grinders

This Jacobs geared chuck threads on right hand spindle of 6" Bench Grinders (1/2"-13 thread). Holds drill bits, reamers, sanding pads, wheel arbors, etc.

No. 6405	1/2" Threaded Chuck (Right Hand)	\$8.00
----------	----------------------------------	--------

Adjustable Lamp

No. 22173	"Goose-Neck" Lamp with Socket, Switch, etc. . . . may be screwed or bolted at back of Bench Grinder	\$7.25
-----------	---	--------



CUTTER DRESSER

DIAMOND DRESSER



COTTON BUFFS



Black & Decker

**ELECTRIC
TOOL
HEADQUARTERS**



Available in—

- 3 WIRE SIZES.
- 1, 2, 3, 4 Section WIDTHS.
- 6 WHEEL DIAMETERS.

WHIRLWIND* Wire Wheel Brushes

MADE BY US, on our own special machines, Whirlwind Brushes give longer service on high-speed operations. Each tuft is locked independently; hence a more dense and even brushing surface and less danger of loose wire. The wire sizes, number of sections and brush diameters in the complete line adapt Whirlwind Brushes to most any wire brushing job and our arbor hole adaptor system fits them to nearly all grinding, buffing or cleaning machines.

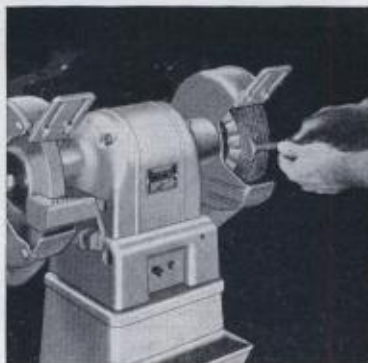

EACH TUFT IS LOCKED INDEPENDENTLY BY SPECIAL MACHINES OF OUR OWN DESIGN.

Arbor Hole Adaptors



Whirlwind Brushes are equipped with washer-type adaptors. Price of Brush includes one set of size shown in table at right. Other sizes, shown in tables below may be substituted if specified on order. Extra sets may also be ordered, in desired sizes, at prices shown.

FOR 6" BRUSHES: Built-in arbor hole plates have 1" hole. Extra adaptors available in sizes below. Same adaptors fit 1, 2 or 3 section Brushes. PRICE, per pair \$.06

Cat. No.	Hole Size	Cat. No.	Hole Size
14080	1/2"	14082	3/4"
14081	5/8"	14771	7/8"

FOR 7", 8", 10" and 12" BRUSHES: Built-in arbor hole plates have 2" hole. Extra adaptors available in sizes shown below. Same adaptors fit 1, 2, 3 or 4 section Brushes. PRICE, per pair \$.14

Cat. No.	Hole Size	Cat. No.	Hole Size
14069	3/4"	14074	1 1/4"
14070	3/4"	14075	1 3/4"
14071	7/8"	14076	1 1/2"
14072	1"	14077	1 3/4"
14073	1 1/8"		

.014" Diameter Wire Size (for rough general purpose cleaning)

Diameter of Brush	No. of Sections	Brush Width		Size Arbor Hole Adaptor	Catalog Number	Price Each
		Hub	Face			
4"	1	7/8"	3/4"	3/4"	23200	\$1.10
	2	1 1/8"	5/8"		23201	1.35
	3	1 3/8"	1 1/8"		21397	1.80
6"	1	7/8"	3/4"	3/4"	23202	1.30
	2	1 1/8"	5/8"		23203	1.90
	3	1 3/8"	1 1/8"		21401	2.55
7"	1	7/8"	3/4"	5/8"	23204	1.90
	2	1 1/8"	5/8"		23205	2.65
	3	1 3/8"	1 1/8"		21411	3.40
8"	1	7/8"	3/4"	5/8"	23206	1.95
	2	1 1/8"	5/8"		23207	3.05
	3	1 3/8"	1 1/8"		21405	4.10
10"	4	1 3/8"	1 1/8"	5/8"	21407	6.85
12"	4	1 3/8"	2 3/8"	1 3/4"	21409	8.00

.0118" Wire Diameter Size (for high-speed buffing operations)

Diameter of Brush	No. of Sections	Brush Width		Size Arbor Hole Adaptor	Catalog Number	Price Each
		Hub	Face			
4"	1	7/8"	3/4"	3/4"	27000	\$1.10
	2	1 1/8"	5/8"		27001	1.35
	3	1 3/8"	1 1/8"		27002	1.80
6"	1	7/8"	3/4"	3/4"	27003	1.30
	2	1 1/8"	5/8"		27004	1.90
	3	1 3/8"	1 1/8"		27005	2.55
8"	1	7/8"	3/4"	5/8"	27009	1.95
	2	1 1/8"	5/8"		27010	3.05
	3	1 3/8"	1 1/8"		27011	4.10
10"	4	1 3/8"	1 1/8"	5/8"	27012	6.85
12"	4	1 3/8"	2 3/8"	1 3/4"	27013	8.00

.005" Wire Diameter Size (for fine finishing and burnishing)

Diameter of Brush	No. of Sections	Brush Width		Size Arbor Hole Adaptor	Catalog Number	Price Each
		Hub	Face			
4"	1	7/8"	3/4"	3/4"	23208	\$1.60
	2	1 1/8"	5/8"		23209	2.25
	3	1 3/8"	1 1/8"		23210	3.15
6"	1	7/8"	3/4"	3/4"	23211	2.30
	2	1 1/8"	5/8"		23212	4.00
	3	1 3/8"	1 1/8"		23213	5.65
8"	1	7/8"	3/4"	5/8"	23217	3.05
	2	1 1/8"	5/8"		23218	5.00
	3	1 3/8"	1 1/8"		23219	7.10

* Trade-Mark Reg. U. S. Pat. Off.



Black & Decker

ELECTRIC
TOOL
HEADQUARTERS

Portable Electric Hammers

COMPLETELY self-contained, operated by "universal" motors, require no transformers or rectifiers. Positive motor drive, through reducing gears, develops hammer action by oscillating a weight and spring assembly. A definite "follow-through" stroke produces high efficiency.

Use to speed up any drilling or cutting operation requiring a hammer action; drill and channel in concrete, stone and brick; caulk joints and seams; remove scale and rust; tamp and vibrate concrete forms; gouge and chisel trees, timbers, etc.

**Specifications
on next page.**





Black & Decker

ELECTRIC
TOOL
HEADQUARTERS

CUTAWAY
1 1/8-INCH
HAMMER



2-inch Portable Electric Hammer (Type D)

Operating Range: Efficient... 1 1/4" to 2"; Extreme... 1 1/8" to 2".
Blows Per Minute 1950. Overall Length... 20 1/4".
Weight: Net 29 1/4 lbs.; Shipping 44 lbs.
Standard Equipment—One No. 33745 turning handle; one No. 33761 (1 1/2") star drill; 3-conductor cable and plug; trigger switch; tool retaining yoke mounted on barrel; carrying case and can of oil; "universal" motor.

Standard Voltage—115 or 220 (for other available voltages, see page 1).

Catalog No. 105 (specify voltage)

Price, complete **\$215.00**

1 1/8-inch Portable Electric Hammer

Operating Range: Efficient... 3/4" to 1 1/8"; Extreme... 1/4" to 2".
Blows Per Minute 2200. Overall Length... 18 1/8".
Weight: Net 19 1/4 lbs.; Shipping 31 lbs.
Standard Equipment—One No. 22754 chuck wrench; one dust shield; one No. 7096 (1") star drill; 3-conductor cable and plug; trigger switch; tool retaining spring; drift key; carrying case and can of oil; "universal" motor.

Standard Voltage—115 or 220 (for other available voltages, see page 1).

Catalog No. 104 (specify voltage)

Price, complete **\$168.00**

3/4-inch Portable Electric Hammer

Operating Range: Efficient... 1/4" to 3/4"; Extreme... 1/4" to 1 1/8".
Blows Per Minute 2300. Overall Length... 14 3/8".
Weight: Net 10 3/4 lbs.; Shipping 22 lbs.
Standard Equipment—One No. 22587 chuck wrench; one dust shield; one No. 7162 (5/8") star drill; 3-conductor cable and plug; trigger switch; tool retaining spring; drift key; carrying case and can of oil; "universal" motor.

Standard Voltage—115 or 220 (for other available voltages, see page 1).

Catalog No. 103 (specify voltage)

Price, complete **\$138.00**

1/2-inch Portable Electric Hammer

Operating Range: Efficient... 1/4" to 1/2"; Extreme... 1/4" to 1 1/8".
Blows Per Minute 2400. Overall Length... 12 3/8".
Weight: Net 5 3/4 lbs.; Shipping 15 lbs.
Standard Equipment—One No. 22587 chuck wrench; one dust shield; one No. 7161 (1/2") star drill; 3-conductor cable and plug; rocker-type switch; tool retaining spring; drift key; carrying case and can of oil; "universal" motor.

Standard Voltage—115 or 220 (for other available voltages, see page 1).

Catalog No. 102 (specify voltage)

Price, complete **\$105.00**

Operating Principle

• The Universal Motor drives the crank through a reduction gear train. The crank, through the connecting rod, powers the piston. Operating in a metal sleeve, the piston imparts its force to a ram that strikes the actual blow on the tool shank in the nose piece.

• Secret to success of this construction is that the piston does not actually strike the ram, although its energy is imparted to the ram. An air cushion, always between the ram and the piston, is the medium through which this energy is transferred. This air cushion serves alternately as vacuum and pressure.

• The vacuum created by the piston on its up-stroke will draw the ram after it and put the ram in a position to deliver its blow. On the impact stroke, the air cushion serves as pressure on the ram when the piston is thrown forward in the ram cylinder. This principle avoids direct hammering action within the unit itself, a condition which would waste energy, create heat and increase wear.

• The coil spring is important. When the ram strikes the tool shank its energy is not entirely expended in the impact. Rebound of the ram represents additional or unused energy. The working force stored in the rebound is captured by the coiled spring—and delivered back to the ram on its next impact stroke.

• While basically simple, many highly technical engineering principles are combined to accomplish a coordinated unit. Manufacture and assembly follow highest precision standards, with closely controlled quality materials. Net result, important to you, is an Electric Hammer with peak work-output.



1/2" HAMMER
Efficient,
1/4" to 1/2"
Extreme,
1/4"-1 1/4"

3/4" HAMMER
Efficient,
1/4" to 3/4"
Extreme,
1/4"-1 1/8"

1 1/8" HAMMER
Efficient,
3/4" to 1 1/8"
Extreme,
1/4"-2"

2" HAMMER
Efficient,
1 1/4" to 2"
Extreme,
1 1/16"-2"

Operating Range of B&D Portable Electric Hammers—

"Efficient Operating Range" (black circles) indicates maximum and minimum hole sizes in concrete, between which each Hammer does its most efficient work. "Extreme Operating Range" (orange circles) indicates the limits to which each Hammer can be used in emergency. If bits or drills below the Efficient Operating Range are used, there is danger of excessive bit breakage. If drills above the Efficient Operating Range are used, work will be noticeably slower and less satisfactory.

Hammer Tool Shanks and Tapers

With the specifications for each of the Hammer Tools listed on the next two pages, you will note that a definite shank or taper is specified. The Hammers with which each tool may be used are also specified. However, if you need more information on the shape and uses of these shanks and tapers, please refer to the data given below.

- Shank #1—Fits nose of 1/2" or 3/4" Hammers.
- Shank #2—Fits nose of 1 1/8" or 2" (former type C) Hammers. Tools with this shank may be rotated by using Turning Handle No. 21726.
- Shank #3—Fits nose of 1 1/8" or 2" (former type C) Hammers. These shanks will not rotate in the Hammer nose piece.
- Shank #4—Fits nose of 2" (latest type D) Hammer. Tools with this shank may be rotated by using Turning Handle No. 33745, standard equipment with this Hammer.
- Shank #5—Fits nose of 2" (latest type D) Hammer. These shanks will not rotate in the Hammer nose piece.
- Taper A—(1) Fits into Chuck Wrench No. 22587, standard equipment with 1/2" and 3/4" Hammers.
(2) Fits into Chuck Wrench No. 22749. This Chuck Wrench fits into nose of 1 1/8" or 2" (former type C) Hammer.
- Taper B—(1) Fits Chuck Wrench No. 22754, standard equipment with the 1 1/8" Hammer; extra equipment for the 2" (former type C) Hammer.
(2) Fits Chuck Wrench No. 23806, extra equipment for 1/2" or 3/4" Hammers.
(3) Fits Chuck Head No. 33747, extra equipment for the 2" (latest type D) Hammer.
(4) Fits Chuck Head No. 22510, extra equipment for 1 1/8" or 2" (former type C) Hammer.

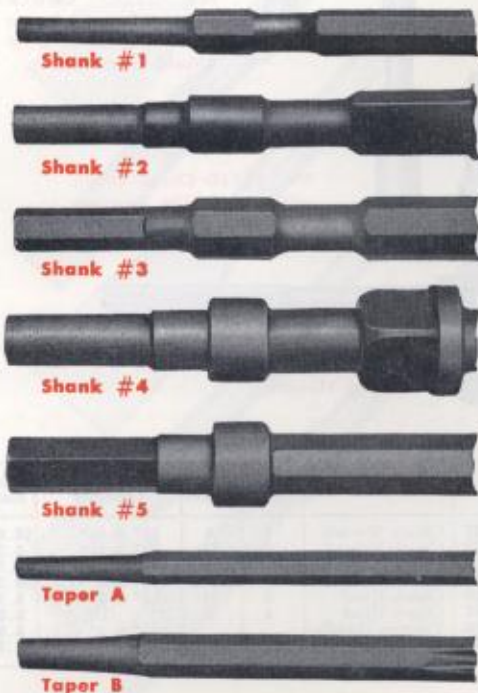



Black & Decker

ELECTRIC
TOOL
HEADQUARTERS



Star Drills

For 1/4" to 3/4" hole sizes—with Taper "A" shanks.

- For: (1) 1/2" Hammer. Point diameters *above* 1/2" are beyond *efficiency* range of this Hammer.
 (2) 3/4" Hammer.
 (3) 1 1/8" Hammer. Use Chuck Wrench No. 22749. Bit breakage may be excessive when using this group of bits with the 1 1/8" Hammer.

Cat. No.	Point Diam.	Overall Length	Quant. in box	Price Each	Cat. No.	Point Diam.	Overall Length	Quant. in box	Price Each
7167	3/8"	5"	6	\$0.85	7162	5/8"	9"	6	\$1.00
7168	1/2"	5"	6	.90	9372	5/8"	18"	1	1.75
7160	3/8"	5"	6	.90	7171	1 1/8"	9"	6	1.20
7169	1/2"	5"	6	.95	7163	3/4"	9"	6	1.25
7161	3/8"	9"	6	.95	9380	3/4"	18"	1	1.90
9364	5/8"	18"	1	1.55	9382	3/4"	24"	1	2.40
7170	5/8"	9"	6	1.00					

For 11/16" to 1 1/8" hole sizes—with Taper "B" shanks.

- For: (1) 3/4" Hammer. Use Chuck Wrench No. 23806. Point diameters *above* 3/4" are beyond *efficiency* range of this Hammer.
 (2) 1 1/8" Hammer.
 (3) 2" Hammer. Use Chuck Head No. 22510 with former TYPE "C" 2" Hammer. Use Chuck Head No. 33747 with latest TYPE "D" 2" Hammer. Bit breakage may be excessive when using this group of bits with 2" Hammers.

Cat. No.	Point Diam.	Overall Length	Quant. in box	Price Each	Cat. No.	Point Diam.	Overall Length	Quant. in box	Price Each
24673	1 1/8"	9"	6	\$1.20	9390	7/8"	24"	1	\$2.65
23081	3/4"	9"	6	1.25	7173	1 1/8"	9"	6	1.45
23082	3/4"	18"	1	1.95	7096	1 1/8"	9"	6	1.45
23083	3/4"	24"	1	2.40	9396	1"	18"	1	2.10
7172	1 1/8"	9"	6	1.25	9398	1"	24"	1	2.65
7097	3/8"	9"	6	1.25	10751	1 1/8"	12"	6	1.85
9388	3/8"	18"	1	2.10	10981	1 1/8"	24"	1	3.00

Chuck Wrenches and Turning Handles



No. 22587 Chuck Wrench — shown with No. 17746 Dust Shield attached.

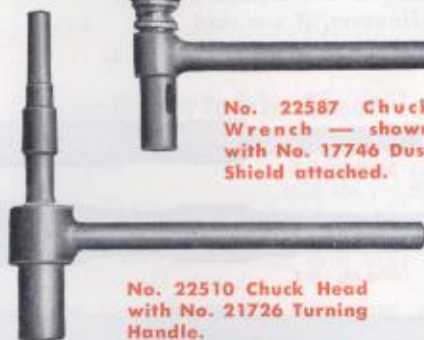

No. 22510 Chuck Head with No. 21726 Turning Handle.



No. 33747 Chuck Head with No. 33745 Turning Handle.

No.	Item	Shank No.	Takes Taper	Use With Hammer	Price Each
22587	Chuck Wrench	1	A	3/8" & 3/4"	\$5.00
23806	Chuck Wrench	1	B	1/2" & 3/4"	5.25
22749	Chuck Wrench	2	A	1 1/8" & 2" (C)	5.50
22754	Chuck Wrench	2	B	1 1/8" & 2" (C)	6.25
22510	Chuck Head	2	B	1 1/8" & 2" (C)	5.50
33747	Chuck Head	4	B	2" (D)	5.00
21726	Turning Handle	1 1/8" & 2" (C)	3.00
33745	Turning Handle	2" (D)	2.75

For 1 1/4" to 2" hole sizes—with No. 4 shanks.

For 2" Hammer, latest TYPE "D" only.

Cat. No.	Point Diam.	Overall Length	Quant. in box	Price Each	Cat. No.	Point Diam.	Overall Length	Quant. in box	Price Each
33757	1 1/4"	18"	1	\$4.20	33762	1 1/4"	30"	1	\$6.00
33758	1 1/4"	30"	1	5.10	33763	1 3/8"	18"	1	5.70
33759	1 3/8"	18"	1	4.75	33764	1 3/8"	30"	1	6.60
33760	1 3/8"	30"	1	5.60	33765	2"	18"	1	6.50
33761	1 1/2"	18"	1	5.10	33766	2"	30"	1	7.20

For 1 1/4" to 2" hole sizes—with No. 2 shanks.

For: (1) 1 1/8" Hammer. Use No. 21726 Turning Handle. All bits in this group are beyond the *efficiency* range of the 1 1/8" Hammer.

(2) 2" Hammer, former TYPE "C."

Cat. No.	Point Diam.	Overall Length	Quant. in box	Price Each	Cat. No.	Point Diam.	Overall Length	Quant. in box	Price Each
21942	1 1/4"	18"	1	\$3.10	21947	1 1/4"	30"	1	\$5.00
21943	1 3/4"	30"	1	3.95	21948	1 3/8"	18"	1	4.35
21944	1 3/8"	18"	1	3.50	21949	1 3/8"	30"	1	5.60
21945	1 3/8"	30"	1	4.65	21950	2"	18"	1	5.00
21946	1 1/2"	18"	1	3.80	21951	2"	30"	1	6.30



Black & Decker

ELECTRIC
TOOL
HEADQUARTERS

Hammer Tools

BULL-POINT (Fig. A)—For demolition drilling.

No. 23804	10" long; shank No. 1 (1/2" or 3/4" Hammer)	\$1.80
No. 23805	18" long; shank No. 1 (1/2" or 3/4" Hammer)	2.50
No. 9036	12" long; shank No. 3 (1 1/4" or 2" Hammer—Type C)	2.40
No. 9410	20" long; shank No. 3 (1 1/4" or 2" Hammer—Type C)	3.30
No. 33662	12" long; shank No. 5 (2" Hammer—Type D)	2.20
No. 33663	20" long; shank No. 5 (2" Hammer—Type D)	3.30

CONCRETE SLOTTING TOOL (Fig. B)—For slotting in concrete and breaking "web" between star drill holes to break large openings in walls, etc.

No. 32112	1 1/4" blade; 11 1/4" long; No. 1 shank (3/4" and 1 1/4" Hammers)	3.95
No. 32113	1 1/4" blade; 18" long; No. 3 shank (1 1/4" and 2" Hammers—Type C)	4.75
No. 33670	1 1/2" blade; 18" long; No. 5 shank (2" Hammer—Type D)	4.00

4-POINT SCALING TOOL (Fig. C)—For removing scale.

No. 17335	9" long; shank No. 1 (3/4" or 1 1/4" Hammer)	2.50
-----------	--	------

SCALING CHISELS (Fig. D)—For removing scale and weld spatter.

No. 12446	1 1/4" blade; 9" long; No. 1 shank (3/4" or 1 1/4" Hammer)	2.35
No. 17314	1 1/2" blade; 9" long; No. 1 shank (3/4" or 1 1/4" Hammer)	2.50
No. 17315	2" blade; 9" long; No. 1 shank (3/4" or 1 1/4" Hammer)	2.60
No. 12401	1 1/4" blade; 12" long; No. 3 shank (1 1/4" or 2" Hammer—Type C)	2.95
No. 22886	2" blade; 12" long; No. 3 shank (1 1/4" or 2" Hammer—Type C)	3.30
No. 22887	2 1/2" blade; 12" long; No. 3 shank (1 1/4" or 2" Hammer—Type C)	4.65
No. 34858	2 1/2" blade; 12" long; No. 5 shank (2" Hammer—Type D)	5.60

COLD CHISELS (Fig. E)—For chipping, edging, channeling.

No. 11108	3/4" blade; 8" long; No. 1 shank (3/4" or 1 1/4" Hammer)	1.65
No. 7095	7/8" blade; 9" long; No. 3 shank (1 1/4" or 2" Hammer—Type C)	1.90
No. 9405	3/4" blade; 20" long; No. 3 shank (1 1/4" or 2" Hammer—Type C)	3.30
No. 34857	7/8" blade; 12" long; No. 5 shank (2" Hammer—Type D)	2.60
No. 33659	7/8" blade; 20" long; No. 5 shank (2" Hammer—Type D)	3.50

FLAT WOOD CHISELS (Fig. F)—For wood gouging and shaping.

No. 9039	2" blade; 9" long; No. 3 shank (1 1/4" or 2" Hammer—Type C)	4.95
----------	---	------

BUSHING TOOL (Fig. G)—For surfacing concrete.

No. 11624	8" long; No. 1 shank (3/4" or 1 1/4" Hammer)	6.85
No. 9040	9" long; No. 3 shank (1 1/4" or 2" Hammer—Type C)	6.85
No. 10684	Bushing Head Only	5.25

SEAM TOOL (Fig. H)—For seaming, caulking and pointing.

No. 17232	9" long; No. 1 shank (3/4" or 1 1/4" Hammer)	2.50
No. 9035	9" long; No. 3 shank (1 1/4" or 2" Hammer—Type C)	2.60

TOOL BLANKS—Can be forged into any special shapes required for special applications.

No. 11107	10" long; No. 1 shank (3/4" or 1 1/4" Hammer)	1.40
No. 7267	12" long; No. 3 shank (1 1/4" or 2" Hammer—Type C)	1.70
No. 33666	12" long; No. 5 shank (2" Hammer—Type D)	2.00

Hammer Supplies

CARRYING CASES—Furnished as standard equipment with Electric Hammers and have ample space for Hammer, Wrenches and a full assortment of tools. Replacement prices are as follows:

No. 18296	Carrying Case for 1/2" Hammer	\$11.00
No. 18389	Carrying Case for 3/4" Hammer	13.50
No. 21003	Carrying Case for 1 1/4" Hammer	16.50
No. 18679	Carrying Case for 2" Hammer	18.50

SPECIAL HAMMER LUBRICATING OIL—

No. 22926	4 Oz. Container	.35
No. 22930	1 Pound Container	.70
No. 22931	2 Pound Container	1.35
No. 32906	5 Pound Container	3.00

DRIFT KEY—Used to remove taper shank bits from Chuck.

No. 7276	For all Chuck Wrenches	.50
----------	------------------------	-----

TOOL RETAINING SPRINGS—To hold straight-shank tool in nose-piece.

No. 10909	Tool Retaining Spring for 3/4" and 1 1/4" Hammer	.20
No. 21750	Tool Retaining Spring for 1 1/4" Hammers	.25

DUST SHIELD—Used in overhead drilling to keep dust out of Hammer nose and mechanism.

No. 17746	For Wrenches Nos. 22587, 23806, 22510	.50
No. 17747	For Wrenches Nos. 22749, 22754	.50





Black & Decker

ELECTRIC
TOOL
HEADQUARTERS

Porto-Shears★

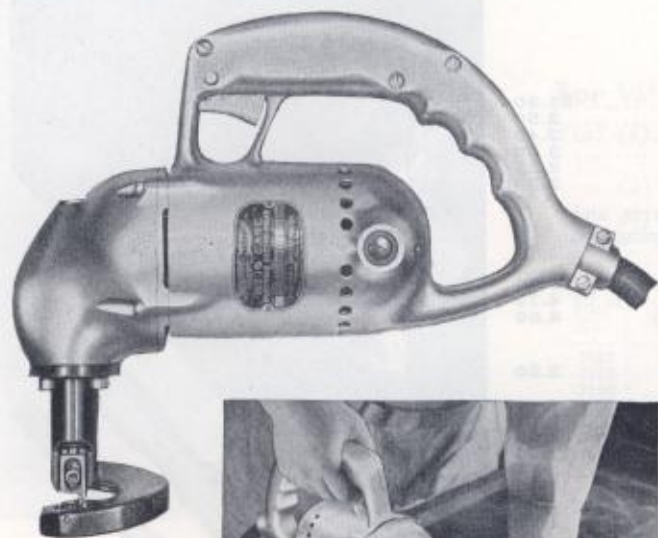

16 GAGE
PORTO-SHEAR

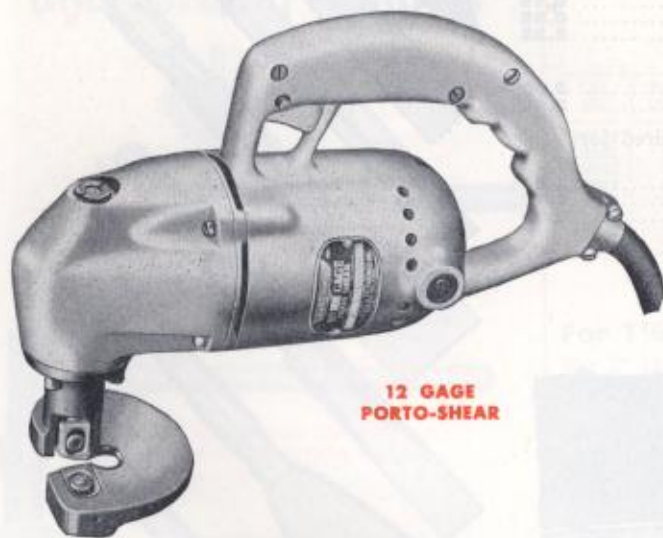

12 GAGE
PORTO-SHEAR

CUT ALL TYPES of sheet metal easily and accurately with these portable tools. A simple adjustment of the blade clearance adapts the Porto-Shear to any thickness up to its rated capacity in sheet steel and galvanized iron; 50% above rating in sheet copper, aluminum, lead and other non-ferrous metals. The 16 Gage unit cuts up to 17 gage and the 12 Gage unit cuts up to 14 gage in Monel and stainless. Sheet plastics and laminated wood in thin sections are also cut successfully with slight changes in blade contours.

A rapid reciprocating action of the vertical blade against the stationary horizontal blade makes a clean, smooth cut without burrs or ragged edges on either piece. Porto-Shears easily follow a straight line or irregular pattern laid out on the sheet, because **the cutting blade is always visible**. The patented shoe construction permits cutting to a small radius and the shoe contour indicates the correct cutting angle. The Porto-Shear feeds easily and only a light forward pressure is required to cut at a surprisingly rapid speed.

Porto-Shears are full ball-bearing equipped (except the eccentric, which operates in a phosphor-bronze block) and powered by "universal" motors which operate on either alternating or direct current.

Specifications

	No. 16 Gage Porto-Shear	No. 12 Gage Porto-Shear
Capacity in Steel—		
U. S. Standard	16 gage	12 gage
Strokes per minute —		
No-load	2500	2000
Full-load	1650	1400
Min. cutting radius	3/4"	1 1/2"
Weight: Net	8 1/2 lbs.	11 lbs.
Shipping	11 lbs.	13 1/2 lbs.
Overall Length	12 1/8"	12 15/16"
Catalog No.	259	507
(specify voltage)	\$90.00	\$135.00
Price, complete		

Standard Equipment—3-wire cable and plug; trigger switch with locking pin; one set of Porto-Shear blades; set-screw wrench; "universal" motor.

Standard Voltages—115 or 220 (For other available voltages, see page 1).

★ Trade Mark Reg. U. S. Pat. Off.

Shear Blade Sharpener

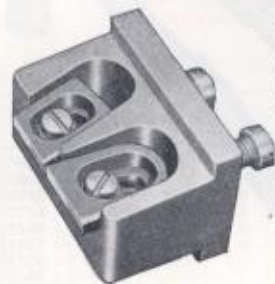

Catalog No. 33202\$3.25

SHARPEN the blades on all Porto-Shears quickly and accurately with this new device. Simple instructions are included which make it practically impossible to grind incorrect angles. Operates by sliding along Bench Grinder tool rest. Illustration shows pair of blades mounted in the Sharpener.

Replacement Blade Kits

For convenience in replacing the shearing blades in Porto-Shears, we have assembled in handy kits all the items necessary for quick and accurate installation of a new set of blades. Each kit includes:

- 1 Vertical Cutter Blade
 - 1 Horizontal Stationary Blade
 - 2 Socket Head Holding Screws
- Adjusting screws, nuts and wrenches for adjusting the blades to correct cutting clearance.

Catalog No. 32105 Replacement Blade Kit for 16 or 18 Porto-Shear, complete ... **\$4.35**

Catalog No. 33088 Replacement Blade Kit for 12 Gage Porto-Shear, complete ... **\$5.75**



Black & Decker

ELECTRIC
TOOL
HEADQUARTERS

No. 95 VACKAR*

Automotive and Industrial Electric Vacuum Cleaner

A SUPER-POWERED, compact, self-contained vacuum cleaner for both automotive and industrial use. With both inlet and outlet hose connections, it can be used as a vacuum cleaner or a blower. Ideal for cleaning floors, walls, ceilings and other parts of the plant. Recovers rivets, metal and similar material. Has hurricane blower action for cleaning motors, transformers, etc.

Baffle plates and filters adapt the No. 95 Vackar to wet cleaning and to removing excess moisture after scrubbing upholstery and carpets. The motor and mechanism are completely protected from moisture and unharmed under such use. Makes an ideal all-purpose cleaner for heavy-duty use in garages, super-service stations, wash-racks, etc.

No. 95 Vackar "tows by the hose" and rolls easily over rough floors on ball-bearing swivel casters. Its 15-foot flexible hose easily reaches out-of-the-way corners. The dirt compartment, with a capacity of 3.7 gallons, is quickly cleaned. Moves 60 cubic feet of air per minute at a speed of 2 miles per minute.

Specifications

Dimensions: Height 28"
Diam. Body 13 1/4"
Diam. Top 16 1/4"
Diam. Base 18 1/2"
Sealed vacuum pull 65"
Vacuum with 1" orifice 18"
Mechanism: "Universal" motor drives 3-stage centrifugal fan moving 60 cu. ft. of air per minute. Baffle plates prevent air slippage.
Weight: Net . 52 lbs.; Shipping . 67 lbs.
Standard Equipment—15 feet of 1 1/2" flexible hose with 2 swivel connections; 3-wire cable and plug; wide upholstery nozzle; detachable brush; flat tube nozzle; 3 ball-bearing swivel casters; brackets for coiling hose and cable; "universal" motor.
Standard Voltages—115 or 220 (For other available voltages, see page 1).

Catalog No. 95 (specify voltage)

Price, complete **\$176.00**

* Trade Mark Registered U. S. Patent Off.



No. 95 Vackar Replacement Attachments

No. 33058	15-foot Flexible Hose, Extra Flexible	\$17.50
No. 23891	Wide Upholstery Nozzle	3.15
No. 23903	Flat Tube Nozzle55
No. 18186	6 1/2" Upholstery Brush	1.25

Additional Industrial Attachments

TO EXPAND the use of the Vackar to industrial cleaning, a special group of attachments is listed below. The various nozzles fit the long rigid operator's handle, which is in two parts (Items A and B). This handle requires the Coupling Adaptor to fit the hose of the No. 95 Vackar. The Blower Tool also uses the Coupling Adaptor to fit the No. 95 Vackar hose.

No. 23902	15-foot Flexible Hose, Semi-Rigid	\$15.50
No. 24834	Operator's Handle—Straight Section* (A)	5.00
No. 24835	Operator's Handle—Curved Section* (B)	5.00
No. 24836	Coupling Adaptor for No. 95 Vackar (C)	1.45
No. 25913	Extension Coupling, to join 2 Hose Sections	1.55
No. 24833	14" Floor Nozzle** (E)	10.85
No. 26083	10" Floor Brush Tool** (D)	16.00
No. 26600	Replacement Nozzle for No. 26083	9.00
No. 26518	Replacement Brush for No. 26083	7.25

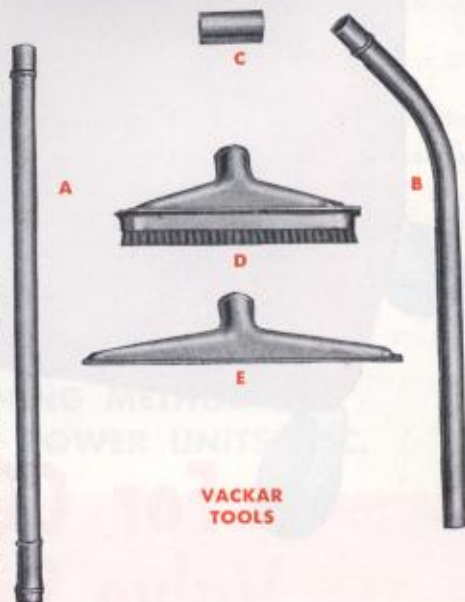

* Use with Adaptor No. 24836 for No. 95 Vackar.
** Fit on end of Operator's Handle; Nos. 24834-24835.



Black & Decker

**ELECTRIC
TOOL
HEADQUARTERS**

A Complete

VALVE SHOP

On Wheels

Includes

★
Adjustable Lamp

★
Super-Service
Wet Grinding
Valve Refacer

★
Stone Dressing Stand

★
Full assortment of
Vibro-Centric Stones,
Stone Sleeves, Pilots
in large fitted drawer
equipped with lock.

★
Storage space for
Vibro-Centric Driver,
and extra equip-
ment.

★
Handsome, Stream-
lined Steel Cabinet
painted brilliant red.

★
Ball-bearing, rubber
casters "roll to the
car."

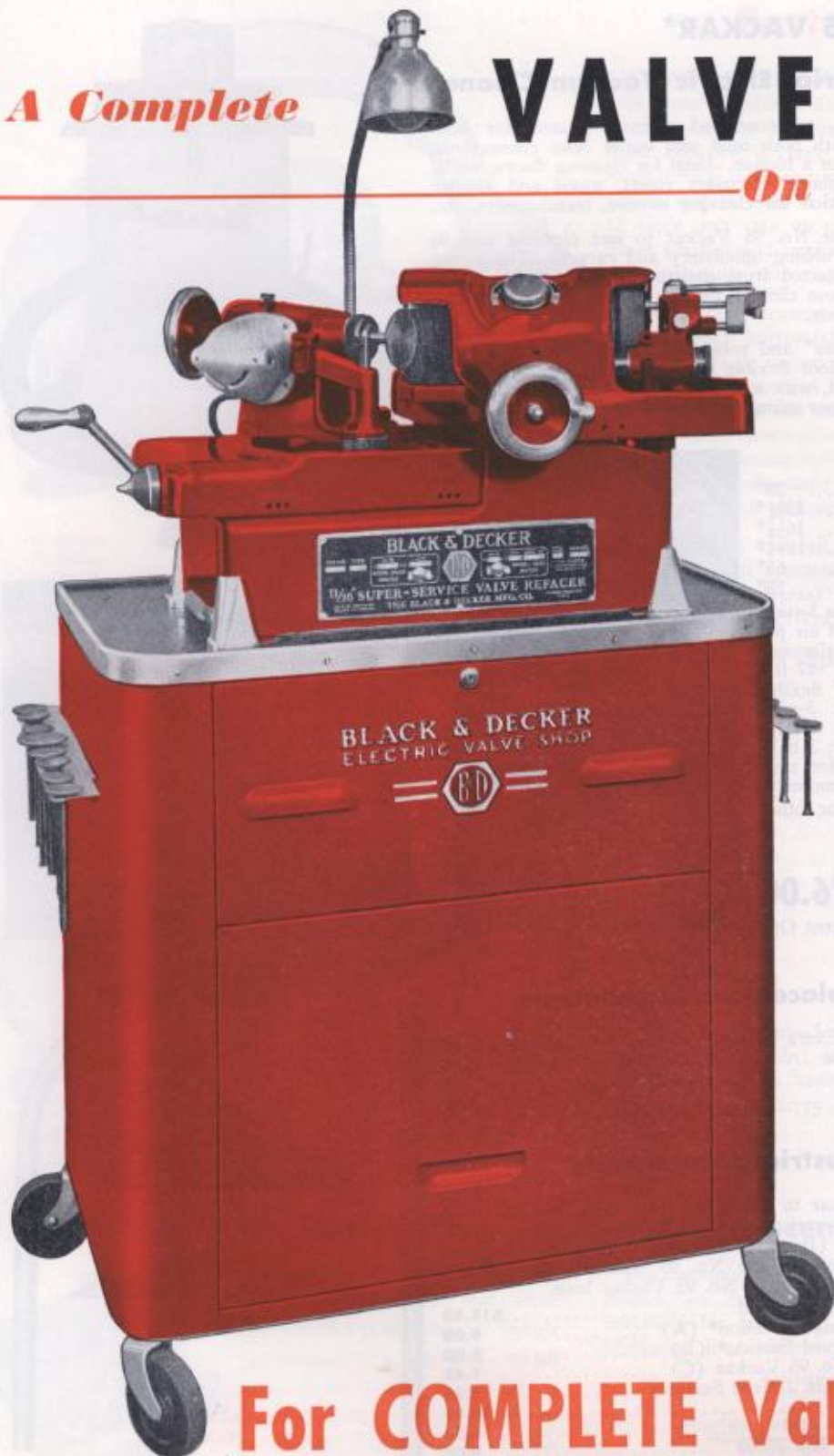

**For COMPLETE Valve and
Valve Seat RECONDITIONING.**



The Black & Decker Electric Valve Shop

THE BLACK & DECKER Electric Valve Shop is the most complete merchandising "package" of precision valve reconditioning equipment on the market. This one cabinet includes everything necessary for a complete precision valve job, and it carries the complete equipment right to the job, saving time and energy in the shop. The modern streamlined appearance of the Valve Shop has great merchandising value, since it can be shown to a prospective customer; inspires confidence in your equipment and ability and helps you to explain the need and method of valve and valve-seat grinding.

The Deluxe Super-Service Valve Refacer produces an absolutely smooth surface and true angle on valve faces. The Vibro-Centric Seat Grinder restores perfect accuracy and mirror finish to all types of valve seats, hard or soft. The complete Valve Shop is engineered to turn out perfectly matched gas-tight valve jobs quickly and profitably.

The cabinet's bench-top holds the Refacer at best working height. The large fitted drawer has trays for all seating stones, stone sleeves, self-centering pilots, carbon removing brushes and Refacer attachments with ample room for additional stones and pilots. The full size lower cabinet has storage space for the Vibro-Centric Driver, drills, gaskets and tools and other parts. Two removable valve trays on each side of the cabinet help to keep valves in correct order. The Valve Shop is equipped with an adjustable lamp; four electric outlets to plug in Refacer, Vibro-Driver, drill and hand lamp; extra long extension cord with third wire for grounding; and four large rubber-tired casters, which roll easily over rough floors.

The Electric Valve Shop is available in different combinations of equipment adapting it to the shop requirements and pocketbook of any shop doing valve work. This is modern precision equipment which you will be proud to own and proud to display to your customers.

Heavy-Duty Electric Valve Shop

- 1 Valve Shop Cabinet.
 - 1 No. 550 Deluxe Super-Service Refacer (Wet-Grinding)
 - 1 Leatherette Refacer Cover.
 - 1 Heavy-Duty 55° Driving Unit.
 - 3 Valve Guide Cleaners:
21441 ($\frac{5}{16}$ "); 21445 ($\frac{3}{8}$ "); 21449 ($\frac{7}{16}$ ").
 - 2 Carbon Cleaning Brushes:
21416 (Heavy-Duty); 21417 (Side Flare).
 - 1 Standard Stone Dressing Stand—No. 20153.
 - 2 Standard Stone Sleeves—No. 22100.
 - 5 Self-Centering Pilots
 - 2 Hard-Seat Stones
 - 7 Soft-Seat Stones
 - 1 Finishing Stone
- } As itemized in Heavy-Duty
} Universal Vibro-Centric Kit.
- Standard Voltages—115 or 220. On special order 125 or 240 volts.

Price, complete as above (specify voltage) . . . Ship. Wt. 293 lbs.

Catalog No. 552 Heavy-Duty Valve Shop \$574.00

Also available for those shops not requiring the *Deluxe* Refacer with provisions for Valve Stem, Tappet and Rocker Arm grinding operations:

Catalog No. 464 Heavy-Duty Valve Shop with No. 282 Refacer \$539.00

Heavy-Duty Deluxe Electric Valve Shop

- 1 Valve Shop Cabinet.
 - 1 No. 550 Deluxe Super-Service Refacer (Wet-Grinding)
 - 1 Leatherette Refacer Cover.
 - 3 Valve Guide Cleaners:
21441 ($\frac{5}{16}$ "); 21445 ($\frac{3}{8}$ "); 21449 ($\frac{7}{16}$ ").
 - 2 Carbon Cleaning Brushes:
21416 (Heavy-Duty); 21417 (Side Flare).
- Contents of Heavy-Duty Deluxe Universal Vibro-Centric Kit; including Heavy-Duty Driving Unit, Heavy-Duty Dressing Stand, 2 Ball Bearing Stone Sleeves, 8 Self-Centering Pilots, 6 Hard-Seat Stones, 7 Soft-Seat Stones, Pilot Turning Wrench.
- Standard Voltages—115 or 220. On special order 125 or 240 volts.

Price, complete as above (specify voltage) . . . Ship. Wt. 308 lbs.

Catalog No. 554 Heavy-Duty Deluxe Valve Shop . . \$647.00

Also available for those shops not requiring the *Deluxe* Refacer with provisions for Valve Stem, Tappet and Rocker Arm grinding operations:

Catalog No. 340 Heavy-Duty Deluxe Valve Shop with No. 282 Refacer \$612.00

Price, Valve Shop Cabinet only (Cat. No. 31363) . . . \$90.00
(Type "E" 35" high, 35" wide, 20" deep—Ship. wt. 130 lbs.)

A COMPLETE VALVE RECONDITIONING METHOD FOR CARS, TRUCKS, TRACTORS, DIESELS, POWER UNITS, ETC.





Black & Decker

ELECTRIC
TOOL
HEADQUARTERS

New DELUXE Super-Service VALVE REFACER

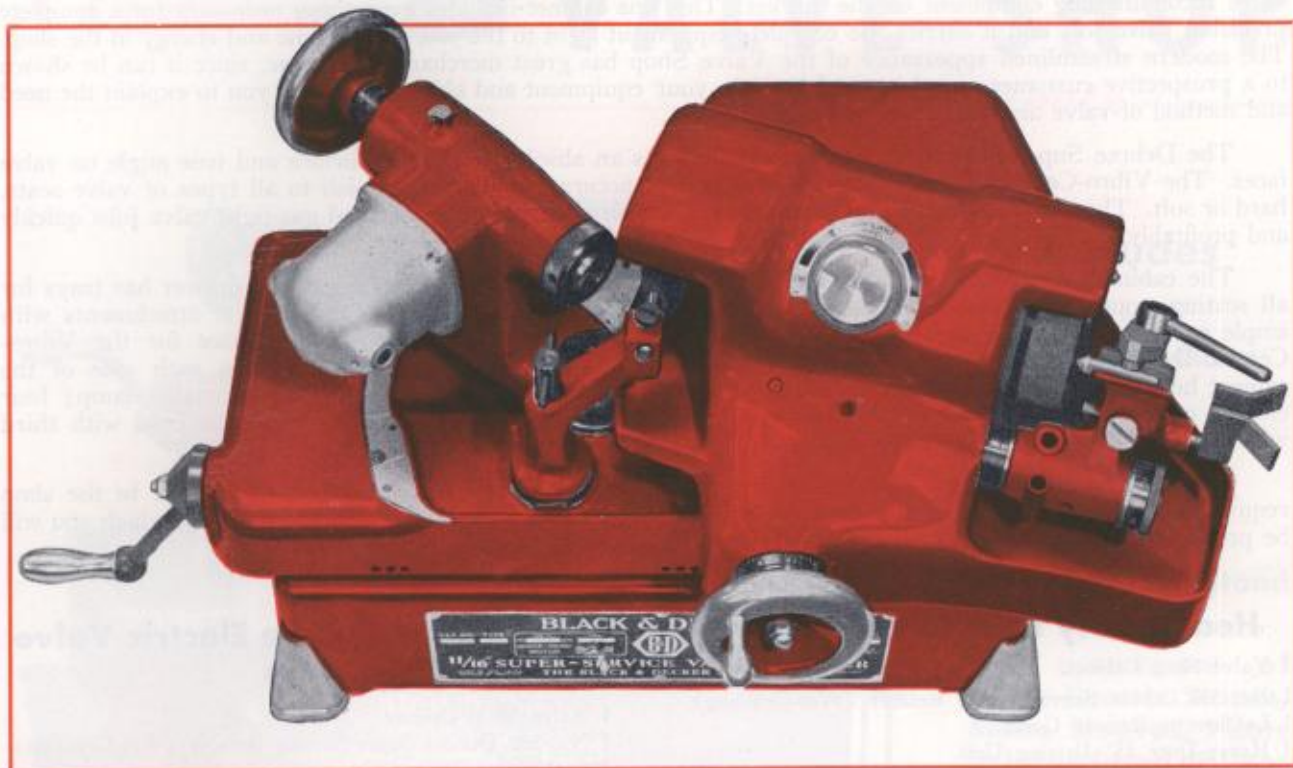

FEATURING

- 9/32" to 11/16" Valve Stem Capacity.
- 0° to 90° Valve Angle Adjustment—*traverse* grind at any *angle*.
- 4" Valve Head Capacity.
- Hypoid gears for smoothest grinding finish.
- Wet grinding at both valve and attachment wheels.
- Universal wheel dresser swivels aside when grinding valves.
- One valve to feed coolant to either grinding wheel.
- 1-gallon tank with baffle plates to clean coolant or grinding oil.
- 4-point bearing suspension on both work and wheel tables.
- Bearing adjustment on feed screws with automatic end play take-up.
- Quick acting collet clamp with double-lead thread.

With numerous improvements for 1953 this DELUXE, precision-built machine now offers ACCURACY, SPEED and OPERATING SMOOTHNESS that is better than ever. It grinds perfect, mirror finishes on valve faces like "clockwork."

Two Black & Decker "universal" motors independently drive the collet and wheel spindles for abundant, smooth power. Coolant pump is mounted on the wheel-head motor with one valve directing the coolant to either wheel.

Examine the many other exclusive features listed at left and shown on the facing page; and then, let this outstanding "buy" in quality valve grinding equipment increase your business and pay for itself out of savings.

Specifications

Valve Stem capacity $\frac{9}{32}$ " to $1\frac{1}{16}$ ". Equipped with 2 Collets, (1) $\frac{9}{32}$ " to $\frac{1}{16}$ "; (2) $\frac{1}{2}$ " to $1\frac{1}{16}$ ".

Valve Head Capacity..... up to 4" Weight: Net 109 lbs.
Angle Adjustment 0° to 90° Shipping 135 lbs.

Standard Equipment—2 "universal" motors (hypoid gear drive on work head, pulley and V-belt on wheel head), 1-gal. coolant tank, universal wheel dresser with diamond, 5" grinding wheel, 4" grinding wheel, attachment for grinding valve stems, tappets or rocker arms, coolant regulating valve with tubes, Allen wrench, grinding wheel coolant, hypoid oil, and leatherette cover to protect entire machine from dust.

Standard Voltage—115 or 220. On special order 125 or 240 volts.

Catalog No. 550 $1\frac{1}{16}$ " Deluxe Super-Service Valve Refacer.

Price, complete **\$360.00**



Black & Decker

ELECTRIC
TOOL
HEADQUARTERS

New DELUXE Super-Service VALVE REFACER

ALL POPULAR valve face angles are calibrated on the work table and the proper angle is set by swiveling the workhead to the correct marking. 15°, 90° (flat type), as well as normal angle valves can be traverse ground without difficulty . . . clearance is provided by a wheel head permanently set at 20° from the direction of work table travel.

Valves may be ground without removing the wheel dresser as this attachment swivels out of the way. Further simplifying operations, it is only necessary to dress the wheel at one angle—parallel to work table travel—for all valve face angles.

One coolant valve on top of wheel head feeds coolant to either grinding wheel . . . liquid flows only at the grinding wheel in use.

Wheel head feed screw is calibrated in thousandths and can be set at zero at any position of the wheel head. This permits controlling the amount of metal removed each time the grinding wheel is advanced. Both feed screws permit bearing adjustment and have automatic end play take-up for wear.

Overall design of this machine is exceptionally "clean" and free from complicated adjustments, structurally weak "gadgets," tubes or wires. Performance in general is unexcelled for valves with stems up to 1½" diameter and heads up to 4" diameter.

A NEW Combined MICROMETER VALVE STEM and ROCKER ARM GRINDING ATTACHMENT is Standard Equipment with the Deluxe Valve Refacer. This attachment is described fully on the next page, but first, examine the circular illustration at right and note the New **QUICK-CLAMP**. It is now only a matter of seconds to place the stem or tappet in the V-way and lock it firmly. Moving the handle to the left opens the device and about a 90° movement to the right closes it.

For shops not requiring a *complete* Valve Refacer—
Catalog No. 282 1½" Refacer. Specifications same as for Cat. No. 550 Deluxe Refacer except for elimination of Valve Stem, Tappet and Rocker Arm Grinding equipment.
Net Weight 98 lbs.; Shipping 124 lbs. **\$325.00**

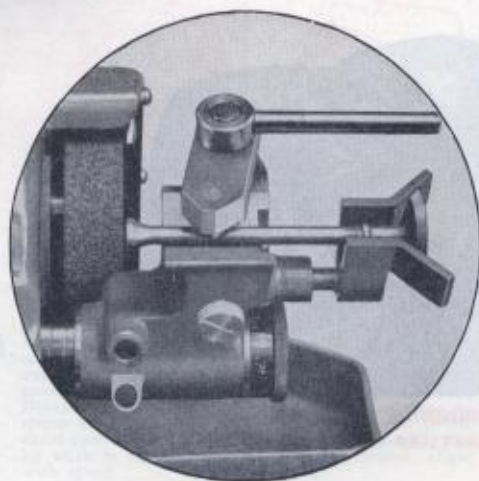
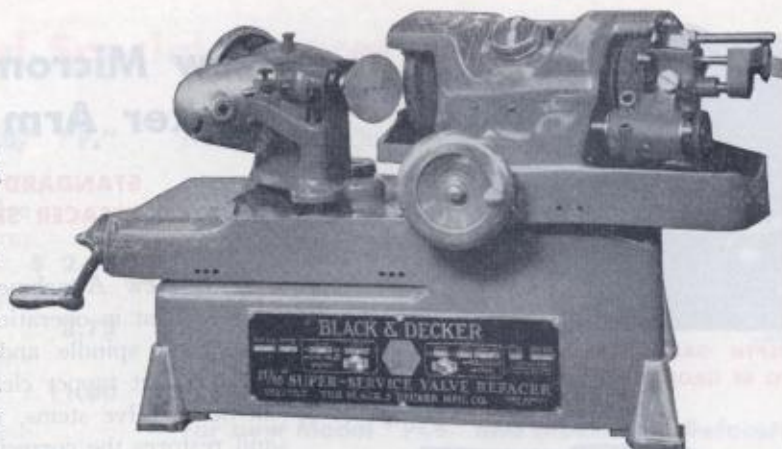



Black & Decker

ELECTRIC
TOOL
HEADQUARTERS

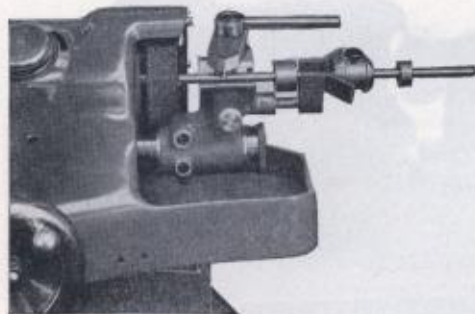

DEPTH GAGE MEASURES AMOUNT TO BE GROUND FROM FORD STEMS

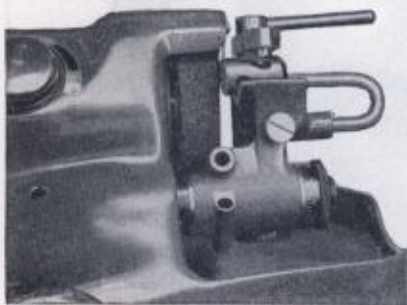

TAPPETS CAN BE GROUND ALL TO THE SAME LENGTH



GRINDING POSITION—
FORD ROCKER ARMS

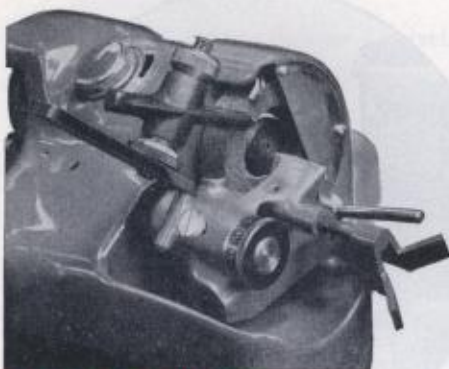

GRINDING POSITION —
CHRYSLER ROCKER ARMS

New Micrometer Valve Stem and Rocker Arm Grinding Attachment

STANDARD EQUIPMENT ON DELUXE REFAKER SHOWN ON PAGES 46, 47.

This New Attachment is extremely accurate and also quick and efficient in operation. It assembles to the outside end of the wheelhead spindle and permits: (1) grinding valve stems to obtain exact tappet clearance on Ford type valves, (2) squares all other valve stems, (3) grinds and trues tappets, (4) grinds and restores the correct radius to all automotive rocker arms.

The complete attachment consists of:

- (1) A sensitive micrometer feed, clearly calibrated in thousandths, mounted on a carefully machined bar, which fits in wheel spindle housing.
- (2) A 4" special recessed wheel, trued across the flat face.
- (3) Allen wrenches for mounting the attachment.

For Valve Stem and Tappet Grinding—

- (4) A "universal" V-block and QUICK-CLAMP, with adjustable V-stop, adapted to varying head sizes and stem lengths. The QUICK-CLAMP also holds tappets for grinding and truing, and holds the diamond point* for dressing the wheel. A U-shaped adjustable stop to permit grinding all tappets to the same length.
- (5) A "universal" depth gage with correct sizes of valve head and port bushings for all Ford V-8, six- and four-cylinder engines.

For Rocker Arm Grinding—

- (6) A double cone clamp, adjustable to the bore of the rocker arm to be ground, mounted on an adjustable arm which handles all automotive rocker arms. The upper cone is newly designed so that after it is placed in position against the rocker arm, less than one turn of the cone firmly clamps the rocker arm.

Catalog No. **34818** Complete Valve Stem and Rocker Arm Grinding Attachment **\$61.00**

* Use diamond point supplied with Refaker.

Hudson Valve-Lifter Grinding Attachment

Used with No. **34818** Attachment. Assembles to rocker arm grinding set-up in place of double cone clamp.

No. **34219** Hudson Grinding Attachment **\$5.00**

Replacement and Special Refacer Equipment

For all Valve Refacers (Models "PCB," "P," "MW," "NW," "NWA," "NWB"):

- No. **20939** 4" Recessed Wheel for Valve Stem, Tappet and Rocker Arm Grinding \$ **2.65**
- No. **18325** Standard Collet (9/32"-9/16" capacity) **8.75**
- No. **15200** Standard Collet (1/2" to 11/16" capacity) **11.00**
- No. **26060** Special Collet for short valve stems (1/4" to 7/16" capacity) **9.00**
- No. **17745** Special Collet for short valve stems (1/2"-11/16" capacity) .. **11.00**
- No. **32742** Cutter-type Wheel Dresser—for Valve Stem Grinding Attachment **4.15**
- No. **5574** Diamond and Nib for Wheel Dresser **3.85**
- No. **20380** 9-oz. Can Grinding Wheel Coolant **.55**
- No. **22946** Pint Can Grinding Wheel Coolant **.75**

- No. **22947** Quart Can Grinding Wheel Coolant **\$1.20**
- No. **22173** Adjustable, "goose-neck" lamp with Socket, Switch, etc. **7.25**
- No. **34253** Grinding Oil—1 gal. **1.75**
- No. **11462** Pin Wrench for tightening Refacer Workhead **.30**

For new Model "PCB" and Model "P" Refacers only

- No. **34131** Standard 5" Wheel for refacing valves **\$5.25**
- No. **34976** 9-oz. Can Hypoid Gear Oil ... **.65**
- No. **34135** V-Belt for wheel motor **1.25**
- No. **34395** Leatherette Refacer Cover **3.85**

For former Model "MW," "NW," "NWA," "NWB" Refacers only

- No. **33056** 4" Grinding Wheel for all valves and fine finishing **\$3.35**

5 simple steps - - The Black & Decker Method of Profitable Valve Reconditioning!

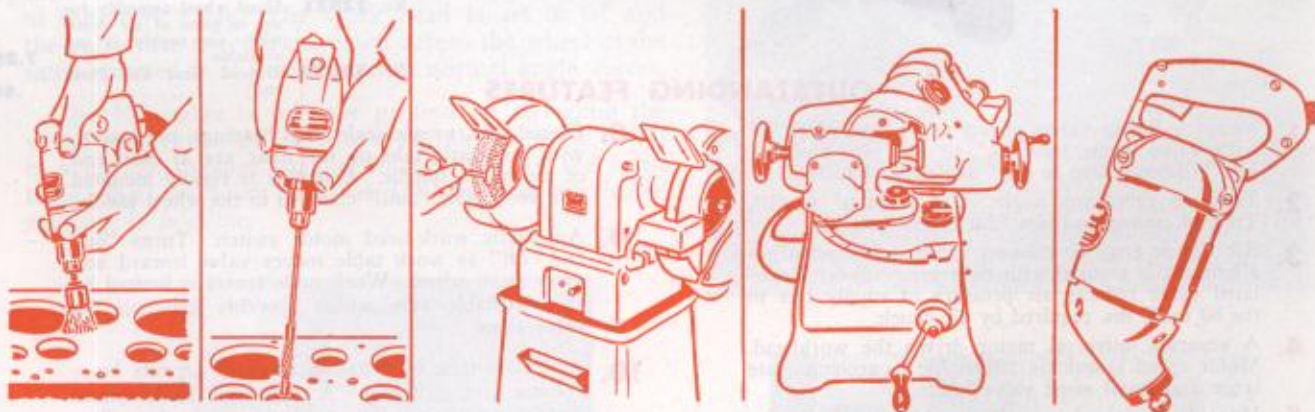

- 1. REMOVE CARBON** from block, pistons, cylinder walls, valve ports, etc. with B&D 1/4" Drill and Carbon Cleaning Brushes.
- 2. REMOVE CARBON** from valve guides with B&D 3/4" Drill and Valve Guide Cleaner. Carbon left in guide will cause inaccurate work.
- 3. REMOVE CARBON** from valves with B&D Bench Grinder and Wire Wheel Brush. Bright, clean valve head, face and stem mean more accurate grinding and a better valve job.
- 4. REFACE VALVES** to a factory-accurate angle and absolutely smooth surface with Deluxe Refacer. Grind stems and tappets for exact clearances. Quality work is turned out with speed.
- 5. GRIND SEATS** to a mirror finish with a Vibro-Centric Grinder. No complicated adjustments or rigging required . . . all grinding is concentric and insures correct alignment.



Black & Decker

ELECTRIC
TOOL
HEADQUARTERS

No. 6 Universal Valve and Tool Grinder

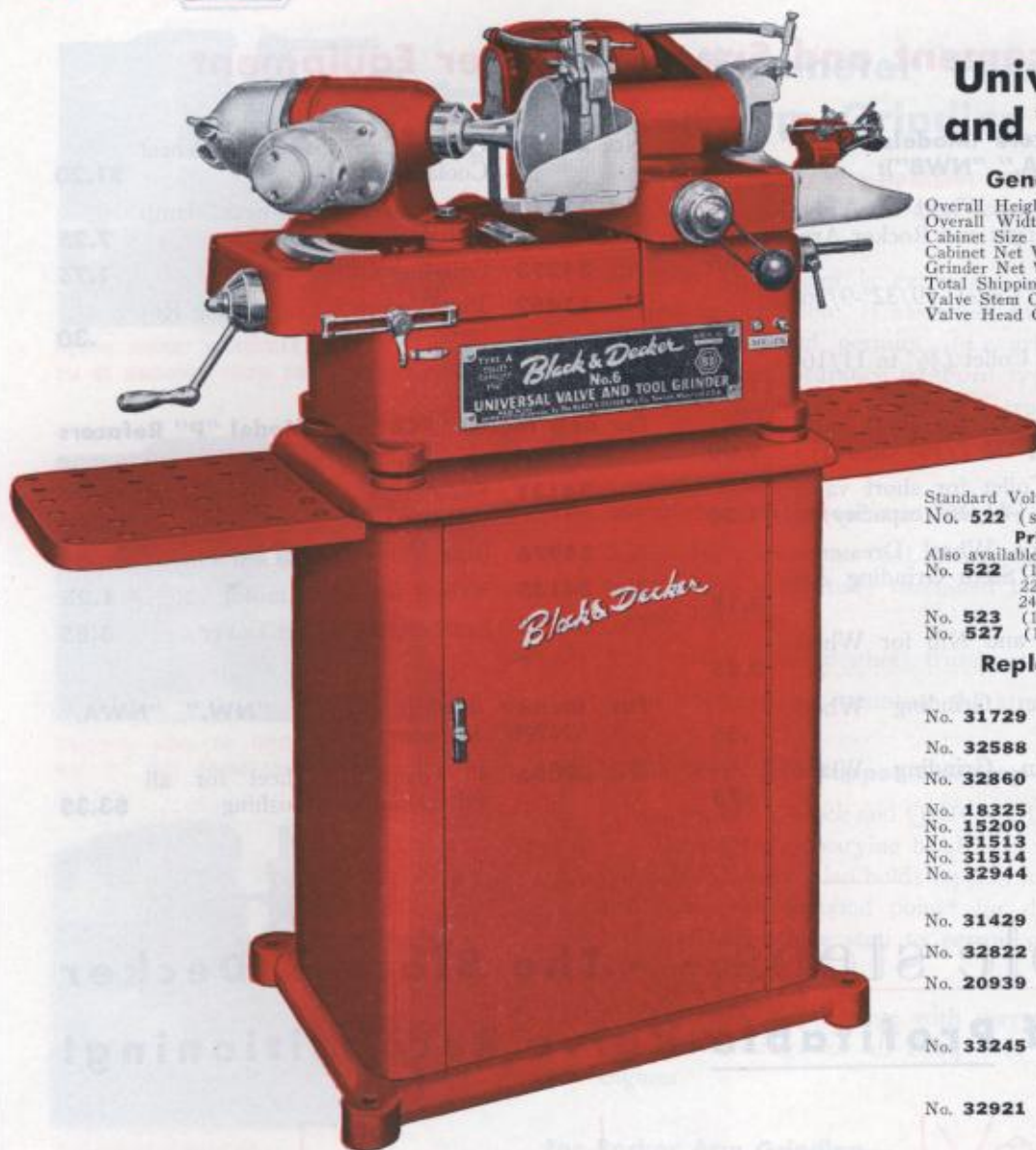

General Specifications

Overall Height	50"
Overall Width	50"
Cabinet Size	29 1/2" x 24" x 16"
Cabinet Net Weight	160 lbs.
Grinder Net Weight	290 lbs.
Total Shipping Weight	500 lbs.
Valve Stem Capacity	3/4" to 1 1/4"
Valve Head Capacity	up to 5 1/4"

Standard Equipment—5 twin-grip collets; 2 collet push rods; 2 nose pieces; Micrometer Valve Stem grinding attachment with Diamond Wheel Dresser; Rocker Arm grinding attachment with Cutter-type Wheel Dresser; Universal Depth Gage; 6" Grinding Wheel; 4" Recessed Grinding Wheel.

Standard Voltage—115V, 1 Ph., 50-60 cycle.

No. 522 (standard voltage) **\$950.00**

Price, complete

Also available on special order:	
No. 522 (125V, 1 Ph., 50-60 cycle; 220V, 1 Ph., 50-60 cycle; 240V, 1 Ph., 50-60 cycle)	\$950.00
No. 523 (115V, 1 Ph., 25 cycle)	950.00
No. 527 (115V, D.C.)	970.00

Replacement and Extra Equipment

No. 31729	V-Belt DC and 60 cycle wheel motor	\$.85
No. 32588	V-Belt 25 cycle wheel motor	1.25
No. 32860	3/4" to 7/16" Collet for short valve stems	9.00
No. 18325	9/32" to 9/16" Collet	8.75
No. 15200	1/2" to 11/16" Collet	11.00
No. 31513	9/16" to 7/8" Collet	13.25
No. 31514	7/8" to 1 1/4" Collet	13.25
No. 32944	6" x 3/4" x 2"—C60 N5V Recessed Grinding Wheel (Standard Equipment)	3.65
No. 31429	6" x 3/4" x 2"—A46 N5V Recessed Wheel	3.65
No. 32822	6" x 3/4" x 2"—C80 N5V Recessed Wheel	5.00
No. 20939	4" Recessed Grinding Wheel for Valve Stems and Rocker Arms (Standard Equipment)	2.65
No. 33245	6" x 3/8" x 2"—C60 N5V Recessed Grinding Wheel with 22° 30' Angle on Face	5.35
No. 32921	Hand wheel assembly for use in place of air chuck when air supply is not available	7.25
No. 34976	Hypoid Gear Oil (9-oz. can)	.65

OUTSTANDING FEATURES

1. Range:—Reface valves of any angle from 0° to 90° with valve stems from 1/4" to 1 1/4" in diameter. Head diameters up to 5 1/4" are easily handled.
2. Traverse grind any angle valve from 0° to 90°. This, of course, includes "flat type" valves.
3. Air Chuck grips or releases valve stem instantly—alignment is assured with twin grip collets. Regulated valve reduces air pressure of supply line to the 80 to 90 lbs. required by air chuck.
4. A separate universal motor drives the workhead. Motor speed is quickly adjustable to accommodate large and small sized valve heads.
5. Hypoid gearing drives the workhead spindle for the smoothest grinding finish.
6. Work table is mounted on slide bearings of simple, clean design. After long service an adjustment for wear can be made without any disassembling of the parts.
7. For abundant power the grinding wheels are driven by a separate 3/4 horsepower constant-speed motor.
8. Closed-type, grease-sealed ball bearings, pre-loaded, with automatic take-up for wear are at each end of the wheel spindle. Assembly is rigidly mounted in a removable "quill" clamped in the wheel saddle.
9. Automatic work-head motor switch. Turns "on" and "off" as work table moves valve toward and away from wheel. Work table travel is limited by an adjustable stop which prevents grinding the valve stem.
10. A drawer-tank of 2 gallon capacity permits large volume wet grinding. A series of baffle plates "settle" grinding sediment. Fluid nozzles have flow control valves and ball-socket joints.
11. Standard equipment includes attachments for grinding Valve Stems, Tappets and Rocker Arms.
12. Tool Grinding: The flexibility and adjustments possible on this machine suit it for many production jobs and machine shop tool grinding operations.



Black & Decker

ELECTRIC
TOOL
HEADQUARTERS

No. 6 Universal Valve and Tool Grinder

AN unequalled combination of engineering and operating features makes this new Heavy-Duty Production Grinder the outstanding leader in valve reconditioning performance. A wide variety of valve sizes can be refaced on a high-speed production basis and also the flexibility of the machine permits many tool grinding operations such as the sharpening of cutters and reamers. Attachments for grinding Valve Stems, Tappets and Rocker Arms are standard equipment. All controls and adjustments are designed for foolproof, rapid operation and performance in general is unexcelled in today's markets.

ALONG with modern heavy-duty, machine tool construction the No. 6 Grinder presents many design innovations for saving time in valve refacing. Among these are the Air Chuck, Automatic Work-Head Switch, Adjustable Work-Head Stop, Adjustable Speed Work-Head Motor, Swiveling Wheel-Head for traverse grinding 15° and 90° valves, and fast-acting, accurate Wheel Dressing Attachments.

All popular valve angles are clearly marked on the work table and the proper angle is set by swiveling the work head. Locking the valve true in its collet is merely a matter of turning the air chuck valve. The work head is driven by a hypoid gear and pinion and both the speed of the work head and the automatic switch on the work table are adjustable to suit the size of the valve being ground.

The traverse grinding of flat type valves is among the many new accomplishments of this machine. The wheel head is swiveled to its full clockwise travel and then the wheel is dressed parallel with the movement of the work table. The work head is set at 0° and the valve face may be traversed across the wheel in the same manner as it would be with normal angle valves.

The 15° valve is traverse ground by swiveling the wheel head to its full 22° travel and dressing the wheel in a normal manner parallel to the travel of the work table. Set the work head at 15° and traverse valve refacing is possible.

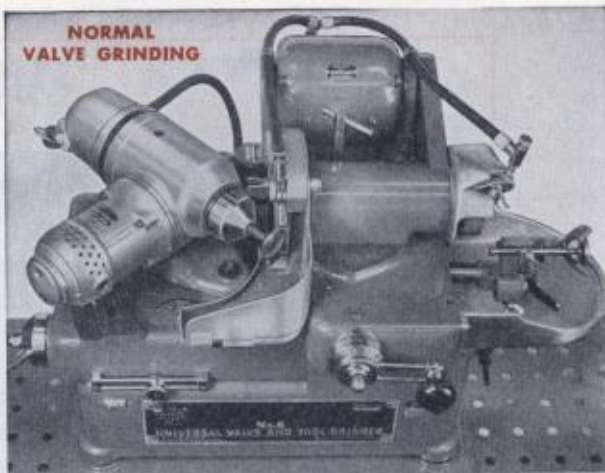

NORMAL
VALVE GRINDING

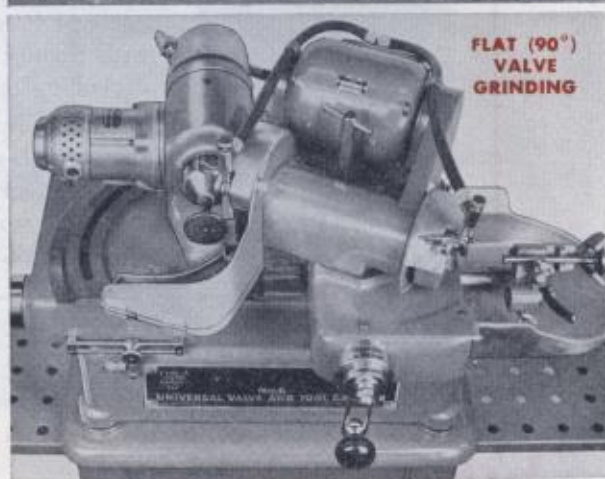

FLAT (90°)
VALVE
GRINDING

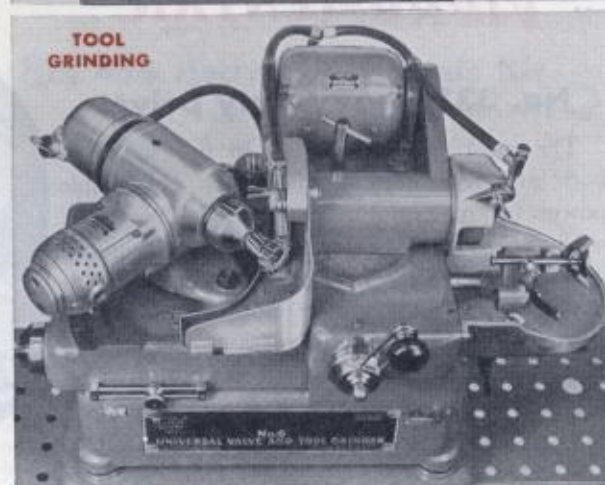

TOOL
GRINDING



ROCKER ARM GRINDING

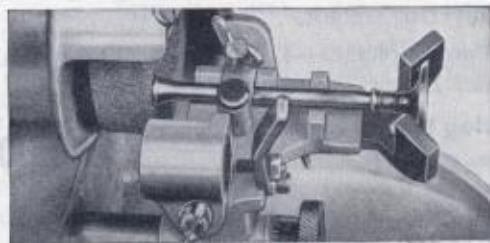

VALVE STEM GRINDING



Black & Decker

ELECTRIC
TOOL
HEADQUARTERS

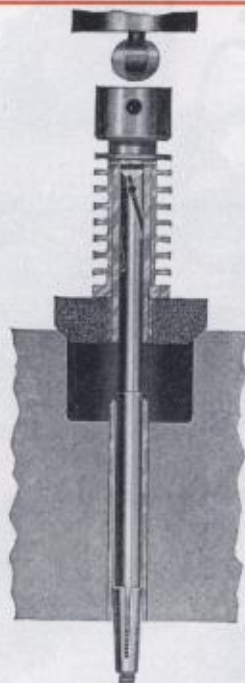

"VIBRO-CENTRIC" REG. U. S. PAT. OFF.

Automotive Valve Seat Grinding

IN ALL Vibro-Centric Drivers, the driving spindle incorporates a positive vibrating action, which lifts the grinding stone from the seat once each revolution. This prevents loading the stone, speeds up grinding and reduces stone wear. All grinding is concentric, cutting the entire circumference of the seat and insuring correct alignment. No complicated adjustment or "rigging" is required.

Only a few seconds are needed to recondition the average cast iron seat—steel inserts take only slightly longer, with Stellite seats requiring several minutes of grinding, depending on eccentricity and wear.

Vibro-Centric Drivers are engineered for years of service in high-speed dry grinding. Heavy-Duty Units maintain high grinding speed with the larger, heavier seat-grinding stones often required in tractor, truck and Diesel work.

"VIBRO-CENTRIC" REG. U. S. PAT. OFF.

No. 331 Heavy-Duty Driver

The most popular Driver in use today in both large and small volume shops. Has ample power for maintaining correct grinding speed with the larger, heavier stones often required in tractors, trucks and larger automobile engines. 55° Angle Drive improves working clearance where body obstructions interfere.

Spindle Speed 12,000 R.P.M.

Weight: Net .6¾ lbs.; Shipping .9¼ lbs.

Overall Length 11½"

Standard Equipment—3-conductor cable and plug; safety trigger switch; hex. ball spindle; "universal" motor.

Standard Voltages—115 or 220. On special order 125 or 240 volts.

Catalog No. 331 (specify voltage) **\$53.00**
Price, complete

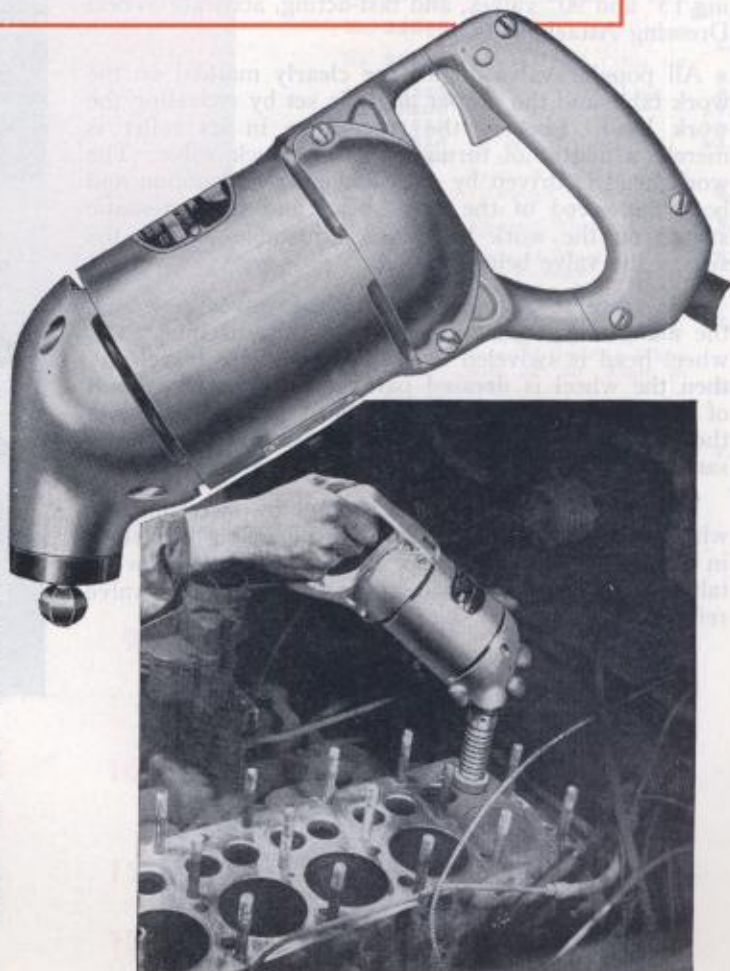

"VIBRO-CENTRIC" KITS



No. 447 HEAVY-DUTY UNIVERSAL KIT

Each Vibro-Centric Kit contains an assortment of precision valve seat grinding equipment ready for on-the-job use. They are designed for the general service shop or car dealer handling a variety of valve reconditioning work.

For large volume shops and shops specializing in valve work, the Deluxe Kits shown on the next page are more versatile and practical than the ones listed here.



All Vibro-Centric Kits are packed in a sturdy oak carrying cabinet. Drawers and fittings keep equipment in place with extra room for additional stones and pilots.

No. 456 Heavy-Duty Basic Kit

Basic equipment, with 55° Heavy-Duty Driver, especially adapted to working in confined space.

- 1 No. 331 Heavy-Duty 55° Driver.
- 1 No. 20153 Standard Stone Dressing Stand.
- 2 No. 22100 Standard Stone Sleeves.
- 1 No. 30776 Universal Kit Box.

Catalog No. 456 (specify voltage)

Price, complete **\$103.00**

No. 447 Heavy-Duty Universal Kit

- 1 No. 331 Heavy-Duty 55° Driver.
- 1 No. 20153 Standard Stone Dressing Stand.
- 2 No. 22100 Standard Stone Sleeves.
- 1 No. 30776 Universal Kit Box.
- 5 "Gruv-Top" Self-Centering Pilots:
 - 14425 ($\frac{5}{16}$ "); 14426 ($\frac{11}{32}$ "); 14427 ($\frac{3}{8}$ "); 14155 (Ford V-8); 23633 ($\frac{11}{32}$ " for Counter-bored Guide).
- 2 Hard Seat Stones: 14049 ($1\frac{3}{4}$ "-45°); 14100 ($1\frac{5}{8}$ "-45°).
- 7 Soft Seat Stones:
 - 14084 ($1\frac{1}{2}$ "-45°); 14063 ($1\frac{3}{8}$ "-45°); 14085 ($1\frac{1}{2}$ "-45°);
 - 14064 (2"-45°); 14198 ($1\frac{1}{2}$ "-30°); 14199 ($1\frac{5}{8}$ "-30°);
 - 14090 ($1\frac{3}{4}$ "-30°).
- 1 Finishing Stone: 14383 ($1\frac{5}{8}$ "-45°).

Catalog No. 447 (specify voltage)

Price, complete **\$140.00**

Catalog No. 30776 Universal Kit Box only **\$22.00**



Black & Decker



NO. 545 HEAVY-DUTY DELUXE UNIVERSAL KIT

No. 408 Heavy-Duty Deluxe Basic Kit

CONTAINS the Heavy-Duty Driver and basic equipment. Enables the large-volume valve shop to assemble stones and pilots to meet their particular or special requirements.

- 1 No. 331 Heavy-Duty 55° Driver
- 1 No. 31672 Heavy-Duty Stone Dressing Stand
- 2 No. 27200 Ball-Bearing Stone Sleeves
- 1 No. 30767 Heavy-Duty Kit Box

Catalog No. 408 (specify voltage)

Price, complete **\$154.00**

No. 6 Vibro-Centric Production Driver

A SUPERLATIVE tool for shops handling valve re-conditioning on a continuous production basis. Available in two separate models: (1) An 8500 RPM Unit for maximum production on valve seats requiring stones up to and including 4" in diameter. (2) A 6000 RPM Unit to handle the large stones often required in Diesel, truck and tractor work. Maintains correct grinding speed with stones up to 6" in diameter.

Specifications

Spindle Speed	8500 RPM	or	6000 RPM
Stone Capacity	0" to 4"	or	4 1/4" to 6"
Net Weight	7 1/2 lbs.	Shipping weight	9 1/2 lbs.
Overall Length	13 7/8"		

Standard Equipment—3-conductor cable and plug; safety trigger switch; hex. ball spindle; "universal" motor.

Standard Voltages—115 or 220 (125 or 240 volts on special order)

Catalog No. 546 (SPECIFY SPEED AND VOLTAGE)

Price, complete **\$70.00**

"VIBRO-CENTRIC" REG. U.S. PAT. OFF.

No. 545 Heavy-Duty Deluxe Universal Kit

THIS KIT contains complete valve seat grinding equipment for large volume shops. Carefully planned assortment of pilots and stones handle a wide range of passenger car, tractor and truck engine valve seats. Especially recommended for shops specializing in valve work.

- 1 No. 331 Heavy-Duty 55° Driver
- 1 No. 31672 Heavy-Duty Stone Dressing Stand
- 2 No. 27200 Ball-Bearing Stone Sleeves
- 1 No. 30767 Heavy-Duty Kit Box
- 1 No. 19829 Pilot Turning Wrench
- 8 Standard "Gruv-Top" Self-Centering Pilots:
14425 (5/16"); 21300 (5/16"); 18608 (5/16");
23633 (11/32"); 14426 (11/32"); 14427 (3/8");
14429 (7/16"); 14155 (Ford V-8)
- 5 Hard Seat 45° Vibro-Centric Stones:
14056 (1 1/2"); 14100 (1 3/8"); 14049 (1 3/4");
14101 (1 7/8"); 14103 (2 7/8")
- 6 Soft-Seat 45° Vibro-Centric Stones:
18541 (1 3/8"); 14084 (1 1/2"); 14063 (1 5/8");
14085 (1 3/4"); 14086 (1 7/8"); 14087 (2 3/8")
- 3 Soft-Seat 30° Vibro-Centric Stones: 14199
(1 5/8"); 14090 (1 3/4"); 14268 (1 7/8")

Catalog No. 545 (specify voltage)

Price, complete **\$217.00**

Catalog No. 30767 Heavy-Duty Kit box
only **\$26.50**



**NO. 6
VIBRO-CENTRIC
PRODUCTION DRIVER**



SPECIAL "VIBRO-CENTRIC" KITS

THESE KITS are for the convenience of tractor and farm implement dealers who sell and service the leading lines of agricultural and industrial tractors and power units. Each Kit has been checked with the tractor manufacturer's service department and contains the correct assortment of Vibro-Centric equipment to recondition current model engines. Each Kit also has room for additional stones and pilots, which can be added at small cost, to handle other makes.

No. 498 "Vibro-Centric" Kit (For Allis-Chalmers Farm Tractors)

Consists of No. 456 Basic Kit plus 2 Self-Centering Pilots, 2 Hard-Seat Stones, 1 Soft-Seat Stone and 3 Finishing Stones.
Catalog No. 498. Price, Complete\$120.00

No. 500 "Vibro-Centric" Kit (For McCormick-Deering-International Agricultural and Industrial Tractors)

Consists of No. 456 Basic Kit with Heavy-Duty Kit Box plus 5 Self-Centering Pilots, 16 Soft-Seat Stones and 4 Hard-Seat Stones.
Catalog No. 500. Price, Complete\$170.00

No. 504 "Vibro-Centric" Kit (For J. I. Case Farm Tractors)

Consists of No. 456 Basic Kit plus 5 Self-Centering Pilots, 6 Soft-Seat Stones and 2 Hard-Seat Stones.
Catalog No. 504. Price, Complete\$144.00

No. 505 "Vibro-Centric" Kit (For Oliver Farm Tractors)

Consists of No. 456 Basic Kit plus 5 Self-Centering Pilots and 8 Soft-Seat Stones.
Catalog No. 505. Price, Complete\$146.00

No. 506 "Vibro-Centric" Kit (For Caterpillar Equipment)

Consists of No. 456 Basic Kit with Heavy-Duty Kit Box plus 1 Pilot Wrench, 8 Self-Centering Expanding Pilots, 9 Soft-Seat Stones, 9 Narrowing Stones and Finishing Stones.
Catalog No. 506. Price, Complete\$239.00

No. 517 "Vibro-Centric" Kit (For Massey-Harris Farm Tractors)

Consists of No. 456 Basic Kit with Heavy-Duty Kit Box plus 1 Pilot Turning Wrench, 8 Self-Centering Pilots, 12 Soft-Seat Stones, and 3 Hard-Seat Stones.
Catalog No. 517. Price, Complete\$186.00



No. 536 KIT

No. 521 "Vibro-Centric" Kit (For John Deere Tractors)

Consists of 1 No. 331 Heavy-Duty Driver, 1 Standard Dressing Stand, 2 Ball Bearing Stone Sleeves, 1 Heavy-Duty Kit Box, 8 Self-Centering Pilots and 12 Soft-Seat Stones.
Catalog No. 521. Price, Complete Kit\$206.00

No. 524 "Vibro-Centric" Kit (For Onan Equipment)

Consists of No. 456 Basic Kit plus 5 Self-Centering Pilots, 1 Plug Pilot, 6 Soft-Seat Stones, 3 Hard-Seat Stones and 3 Finishing Stones.
Catalog No. 524. Kit, Complete as above\$156.00

No. 536 "Vibro-Centric" Kit (For International Trucks, All Current and Recent Models)

Consists of 1 No. 331 Heavy-Duty Driver, 1 Heavy-Duty Dressing Stand, 2 Ball-Bearing Stone Sleeves, 1 Dial Indicator, 1 Pilot Turning Wrench, 1 Heavy-Duty Kit Box, 6 Gruv-Top Self-Centering Pilots and 22 Stones.
Catalog No. 536. Price, Complete\$249.00

No. 584 "Vibro-Centric" Kit (For Briggs and Stratton Engines)

Consists of 1 No. 331 Heavy-Duty Driver, 1 Standard Dressing Stand, 1 Special Dressing Stand Mandrel, 2 Standard Stone Sleeves, 1 Kit Box, 2 Self-Centering Pilots, and 2 Soft-Seat Stones.
Catalog No. 584. Price, Complete\$121.00

No. 585 "Vibro-Centric" Kit (For Minneapolis-Moline Tractors and Portable Power Units)

Consists of No. 456 Basic Kit with Heavy-Duty Kit Box, 2 Self-Centering Pilots, 4 Soft-Seat Stones, 3 Hard-Seat Stones, 5 Narrowing Stones and 4 Finishing Stones.
Catalog No. 585. Price, Complete\$147.00



Black & Decker

ELECTRIC
TOOL
HEADQUARTERS



**HEAVY-DUTY
DRESSING STAND**

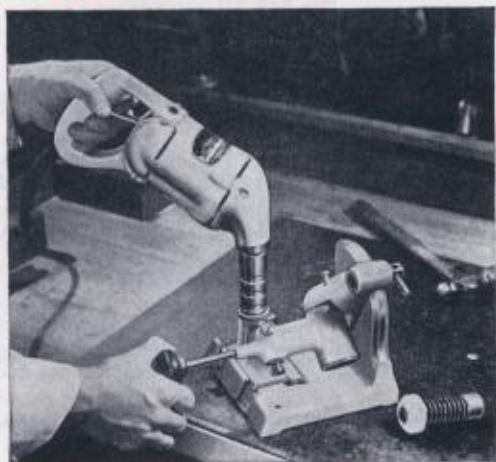

Heavy-Duty Stone Dressing Stand

CATALOG No. 31672

THIS Heavy-Duty Stand for dressing Vibro-Centric Valve Seat Grinding Stones is especially built for shops doing a large volume of valve reconditioning on a "production" basis and desiring a more accurate dresser, with precision features and trouble-free design. It can be used with both Automotive and Aircraft Stone Sleeves and has the following exclusive features:—

- 1—The rigid one-piece base-and-column casting provides a sturdy support on which the bracket for angle adjustment is clamped. The bracket carries the dressing arm. The calibrated segment is read from the top where all markings are accurately stamped into the column. The popular angles are clearly indicated for easy visibility.
- 2—The dressing arm is mounted on Timken tapered roller bearings, sealed against abrasive dust, with a take-up adjustment to remove any trace of play. The arm is spring-mounted to hold it in upward position when not in use; a locking pin holds it in central position for making approximate dressing adjustments.
- 3—The stone dressing mandrel is rigidly held in a sliding block and V-slide-way, clamped in position by screw-locking clamps. The length of the mandrel is quickly adjusted to obtain the correct setting for length of stone sleeve, and angle of stone. The block adjustment covers any diameter of stone and vertical or horizontal grinding.
- 4—The fine adjustment of the diamond feed is equipped with a lock-nut to produce a smooth, uniform finish on the stone.
- 5—Every moving and adjustable part has been carefully machined and fitted to produce absolute accuracy and eliminate play in any adjustment. Adjustments are quickly made with screw-locking clamps.
- 6—The complete Stand can be bolted to the bench.

Specifications (Type B)

Stone Size Capacity	up to 6"
Mandrel Diameter	3/8"
Angle Adjustment	0° to 90°
Weight: Net	15 lbs.
Shipping	17 lbs.

Standard Equipment—Diamond Point; Mandrel; Adjustable Arm with screw-feed diamond nib.

Cat. No. 31672 Heavy-Duty Dressing Stand, complete **\$54.00**

Standard Stone Dressing Stand

CATALOG No. 20153

A sturdy, die-cast Dressing Stand for trimming and cleaning all sizes and angles of Vibro-Centric Valve Seat Grinding Stones up to 3 1/2" diameter. Its accurate angle indicator is easy to set and insures accurate stone dressing. The micrometer diamond feed takes off just enough material to produce a new surface and reduces waste. A horizontal adjustment of the arm accommodates various stone sizes and permits horizontal or vertical cutting.

Specifications (Type B)

Stone Size Capacity	up to 3 1/2"	Angle Adjustment	0° to 90°
Mandrel Diameter	3/8"	Shipping	11 lbs.
Weight: Net	10 1/4 lbs.		

Standard Equipment—Diamond Point; Mandrel; Adjustable Feeding Arm with Micrometer Diamond Feed.

Catalog No. 20153 Standard Stone Dressing Stand, complete **\$22.00**

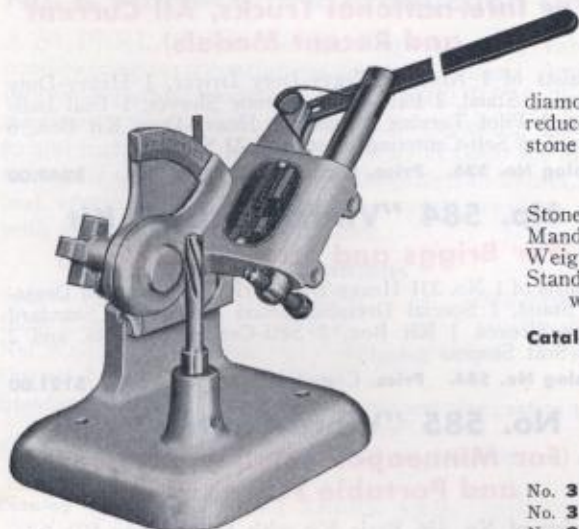

STANDARD DRESSING STAND

Replacement and Special Equipment for Stone Dressing Stands

No. 31662	Diamond Nib complete for No. 31672 Heavy-Duty Stand	\$4.50
No. 31670	Standard Mandrel for Heavy-Duty Dressing Stand	3.15
No. 20157	Diamond Nib for No. 20153 Standard Stand	4.25
No. 20148	Standard Mandrel for No. 20153 Stand	3.15
No. 31115	Special Mandrel for No. 20153 Stand to take extra long stones such as Nos. 27116, 27117, 27118, 27141, 27142	3.60



Black & Decker

ELECTRIC
TOOL
HEADQUARTERS

"GRUV-TOP"

Automotive Expanding Sleeve Self-Centering Pilots

"GRUV-TOP" Self-Centering Pilots provide an accurate, rigid axis for grinding with "Vibro-Centric" Stones. Two machined tapers—at the top of the shank, to fit the top of the valve guide, and at the bottom, to expand a split sleeve in the lower end of the guide. The expanding feature compensates for worn guides and eliminates a large stock of oversize pilots, as Self-Centering Pilots expand .020" to .030".

The patented "GRUV-TOP" feature locks the retainer ball in No. 27200 Ball-Bearing Stone Sleeve, holding the inner sleeve stationary and preventing friction and wear between sleeve and pilot stem. These Pilots also fit other Stone Sleeves listed on page 58.

Nominal Size	Range	Catalog No.	Dimensions		Price Complete	Sleeve No.	Price of Sleeve		
			A	B					
1/4"	.233"-.254"	14423	1 1/8"	2 1/2"	\$ 3.85	13908	\$0.85		
		25245	1 1/8"	3 1/4"	6.50	13908	.85		
5/16"	.277"-.303"	15792	1 1/2"	3 1/2"	6.50	15145	.85		
		14425	1 1/2"	3"	3.85	13902	.85		
3/8"	.308"-.330"	18608	1 1/2"	2 1/2"	6.50	13902	.85		
		16197	1 1/2"	4"	6.50	13902	.85		
		21300†	1 1/2"	3"	3.85	13902	.85		
		16213	1 1/2"	3"	6.50	13902	.85		
		19895	1 1/2"	4"	6.50	13902	.85		
		20970	2"	3 1/4"	10.00	13902	.85		
		23484	2"	2 1/2"	6.50	13902	.85		
		23633*	1 1/2"	2 1/2"	3.85	13904	.85		
		21302	1 1/2"	2 1/2"	3.85	13904	.85		
		11/16"	(for counter-bored guides)	16199*	1 1/2"	3 1/4"	3.85	13904	.85
14420	1 1/2"			3 1/4"	3.85	13904	.85		
24319	1 1/2"			4 1/8"	10.00	13904	.85		
26528	2 1/2"			3 7/8"	6.50	13904	.85		
24310	1 1/2"			2 1/4"	10.00	13904	.85		
26818	1 1/2"			3 1/16"	6.50	13904	.85		
21304	1 1/2"			3 1/2"	3.85	13903	.85		
3/8"	(for counter-bored guides)	14427	1 1/2"	3 1/2"	3.85	13903	.85		
		16201	1 1/2"	3 1/2"	7.50	13903	.85		
		17345	2 1/2"	3 23/32"	6.50	13903	.85		
		32061	1 1/2"	3 23/32"	7.50	13903	.85		
		16204	1 1/2"	4 1/8"	7.50	13903	.85		
		23937	2 1/2"	3 23/32"	6.50	13903	.85		
		20667	2 1/2"	2 21/32"	6.50	13903	.85		
		25206	2"	3 1/2"	10.00	14653	.85		
11/16"	.402"-.424"	14428	1 3/8"	3 1/2"	3.85	13909	.85		
		16826	1 3/8"	4 1/8"	6.50	13909	.85		
		17396	1 1/2"	3 1/2"	10.00	13909	.85		
7/8"	.433"-.455"	14429	2 1/4"	3 1/2"	3.85	13901	.85		
		24343	2 1/4"	3 1/2"	10.00	13901	.85		
		22989	2 1/4"	3 21/32"	6.50	13901	.85		
		15179	2 1/4"	4 1/8"	6.50	13901	.85		
		23971	3 1/8"	3 23/32"	6.50	13901	.85		
		15743	2 1/4"	5 7/8"	7.50	13901	.85		
		17903	3 1/8"	4 1/16"	6.50	13901	.85		
		16784	1 3/8"	3 1/2"	6.50	13901	.85		
		23337	1 1/8"	4 1/8"	6.50	13901	.85		
		25221	1 1/8"	3 21/32"	10.00	13901	.85		
		25219	2 1/4"	4"	10.00	13901	.85		
		1 1/8"	.464"-.495"	14430	2 1/2"	3 1/2"	6.50	13910	.85
				14431	2"	3 19/32"	3.85	13905	.85
16047	2"			4 1/8"	7.50	13905	.85		
23975	3 1/8"			3 19/32"	10.00	13905	.85		
23665	3"			3 1/2"	10.00	13905	.85		
26908	3"			4 1/8"	10.00	13905	.85		
19894	4"			3 19/32"	6.50	13905	.85		
22184	3 1/8"			4 5/8"	6.50	13905	.85		
17643	1 1/2"			3 1/2"	10.00	13905	.85		
25225	2 1/4"			4 5/8"	10.00	13905	.85		
1 1/8"	.5312"-.5625"	27108	2 1/2"	3 23/32"	10.00	24497	1.10		
		14432	2"	3 11/16"	6.50	13899	1.10		
		23522	3 1/8"	3 23/32"	7.50	13899	1.10		
		26864	3 1/8"	4 5/8"	10.00	13899	1.10		
1 1/8"	.558"-.598"	19203	4 1/8"	3 11/16"	10.00	13899	1.10		
		14435*	3 1/2"	3 5/8"	3.85	13899	1.10		
		14433	1 1/2"	3 11/16"	6.50	13906	1.10		
		23939	3 1/2"	2 1/2"	7.50	13906	1.10		
1 1/8"	.621"-.661"	23578	3"	4 7/8"	7.50	13906	1.10		
		26143	5 1/8"	4 3/8"	10.00	13906	1.10		
		15178	2"	3 19/32"	10.00	15046	1.65		
1 1/8"	.683"-.724"	26327	2 7/8"	3 23/32"	10.00	15046	1.65		
		27110	7 1/8"	3 1/2"	12.50	14149	1.65		

* For Chevrolet. # For Ford Model "A." † For counter-bored guides.

"Gruv-Top" Plug Type Automotive Pilots

Range	Catalog No.	Engine	Price Complete
.8458"-.8525"	18248	Ford "60"	\$3.85
1.0278"-.1.0330"	14155	Ford "V-8"	3.85

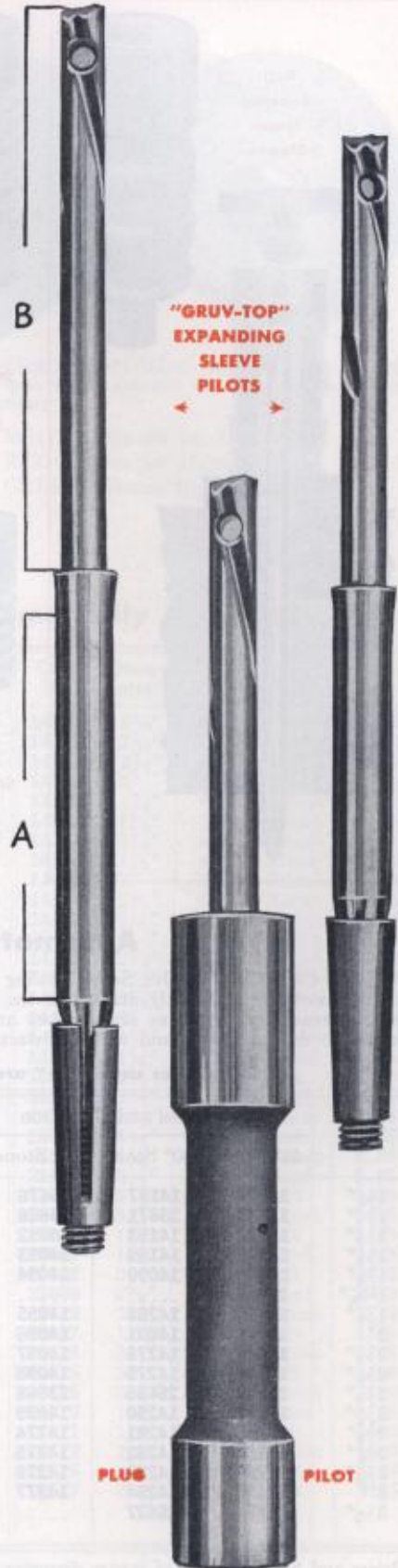



Black & Decker

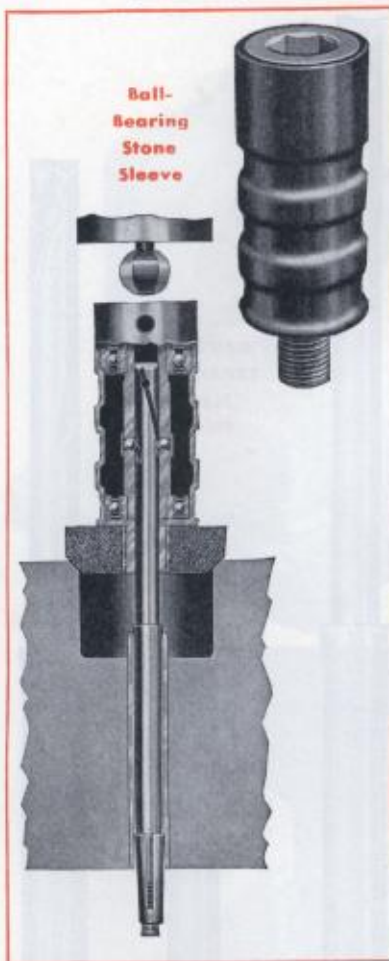

Ball-Bearing Stone Sleeve



Standard Stone Sleeve



Short Standard Stone Sleeve

Automotive Stone Sleeves

AUTOMOTIVE Seat-Grinding Stones have threaded bushings and are interchangeable on any of the following Automotive Sleeves which fit over Self-Centering Pilots and hold the stone in correct alignment with the pilot. Upper end of the sleeve is a hexagon socket which forms a universal joint with the Driver spindle.

Standard Automotive Stone Sleeve—Long bronze bushing accurately reamed to fit Pilot.
 No. 22100 Standard Vibro-Centric Stone Sleeve..... **\$3.85**

Short Standard Automotive Stone Sleeve—For increased clearance on hard-to-reach seats. Overall length, 2 3/4". Use with Stand 20153 with 25247 Mandrel; or 31672 H.D. Stand.
 No. 23652 Short Standard Vibro-Centric Stone Sleeve..... **\$3.85**

Ball-Bearing Automotive Stone Sleeve—Designed to minimize wear, to preserve accuracy and give longer service. Ball-bearings are between inner and outer sleeve.

No. 27200 Ball-Bearing Stone Sleeve with retainer ball for "Gruv-Top" Pilots **\$11.00**
 No. 19825 Ball-Bearing Stone Sleeve without retainer ball **11.00**

Pilot Turning Wrench

Pilot Turning Wrench, to prevent injury to user's hands while inserting or removing Self-Centering or other Pilots. Equipped with chuck which quickly grasps or releases Pilot shank.

No. 19829 Pilot Turning Wrench **\$5.00**



Valve Seat Indicator

FOR testing the concentricity of valve seats. Calibrated to 1/1000 of an inch. In operation the indicator is placed on the pilot, the top section being held firmly on the pilot while the lower section is rotated with adjustable arm in contact with the valve seat. Plus or minus variations in the seat are read on the dial during rotation.

No. 13725 Dial Indicator **\$20.00**



Automotive Valve Seat Grinding Stones

"VIBRO-CENTRIC" Valve Seat Grinding Stones are carefully formed and accurately dressed at the factory to grind smooth, true faces on valve seats. They are made in three grades to do the fastest and most satisfactory work on all

types of seats; one grade is for the average cast iron or soft steel seats found in most engines; another grade is for faster grinding of hard steel, stellite and other hard alloy inserts; a third grade is for a highly polished "finish grind" on all seats.

Stones under 2 1/2" are vitrified. 2 1/2" in diameter and over are resinoid bonded.

Size	For Soft Steel and Cast Iron			For Hard Steel and Stellite			Size	For Finish-Grinding		Price Each
	45° Stone	30° Stone	20° Stone	45° Stone	30° Stone	20° Stone		45° Stone	30° Stone	
1 1/4"	14216	14197	25676	14217	14218	1 1/4"	14414	14413	\$1.85
1 3/8"	18541	25671	23666	18540	25670	23667	1 3/8"	18542	25672	1.85
1 1/2"	14084	14198	14092	14056	14219	14107	1 1/2"	14382	14370	1.85
1 5/8"	14063	14199	14093	14100	14287	14108	1 5/8"	14383	14371	1.85
1 3/4"	14085	14090	14094	14049	14105	14109	1 3/4"	14384	14372	1.85
1 13/16"	23957	1 13/16"	1.85
1 7/8"	14086	14268	14095	14101	14288	14110	1 7/8"	14385	14373	1.85
2"	14064	14091	14096	14102	14106	14111	2"	14386	14374	1.85
2 1/8"	14087	14278	14097	14103	14289	14112	2 1/8"	14387	14375	2.30
2 1/4"	14088	14279	14098	14104	14290	14113	2 1/4"	14388	14376	2.30
2 3/8"	16929	25635	23668	16951	23669	2 3/8"	23670	25636	2.30
2 1/2"	14089	14280	14099	14050	14291	14114	2 1/2"	14389	14377	2.30
2 5/8"	14285	14281	14274	14239	14292	14270	2 5/8"	14390	14378	3.00
2 3/4"	14153	14282	14275	14200	14293	14271	2 3/4"	14391	14379	3.00
2 7/8"	14286	14283	14276	14295	14269	14272	2 7/8"	14392	14380	3.00
3"	14154	14284	14277	14243	14294	14273	3"	14393	14381	3.00
3 1/2"	21474	26527	21473	3 1/2"	21475	25634	3.85

Prices and Specifications of larger diameter stones can be secured on application.



Black & Decker

ELECTRIC
TOOL
HEADQUARTERS

"VIBRO-CENTRIC" REG. U. S. PAT. OFF.

Automotive Valve Seat Grinding Stones

Special and Multiple-Angle Stones:

No. 24494	1 1/2" x 12°30' (for Chevrolet)	\$2.35
No. 26284	1 3/8" x 90° x 30°	1.85
No. 24493	2 3/8" x 10°45' and 55° (for Chevrolet)	3.00
No. 26285	2-5/16" x 30° x 20°	3.10
No. 25632	2 3/8" x 15° (Soft Seat)	3.00
No. 25638	2 3/8" x 15° (Finishing)	3.00
No. 25669	2 3/8" x 15° (Hard Seat)	3.00
No. 26147	2-11/16" x 90° x 30°	3.00
No. 27116	1 3/4" x 45° extra deep, for Hard Seats	2.80
No. 27117	1 3/4" x 45° extra deep, for Soft Seats	2.80
No. 27118	1 3/4" x 45° extra deep, for Finishing	2.80
No. 27141	1 3/4" x 20° extra deep, for Hard Seats	2.80
No. 27142	1 3/4" x 20° extra deep, for Soft Seats	2.80
No. 23821	1-9/16" x 70° (Soft Seat)	1.85
No. 23822	2-1/16" x 70° (Soft Seat)	2.30
No. 23823	2 3/8" x 70° (Soft Seat)	2.30
No. 23824	2 3/8" x 70° (Soft Seat)	2.30

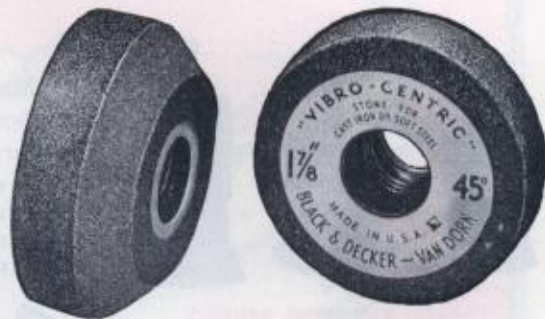

Vibro-Centric Stone labels are enameled surface blotters which are colored as follows for quick identification:

WHITE—Stones for Soft Seats
RED—Stones for Hard Seats
GREEN—Stones for Finishing

Standard Automotive Vibro-Centric Stones (Numerically Arranged)

Cat. No.	Diameter	Face Angle	Type	Price Each	Cat. No.	Diameter	Face Angle	Type	Price Each	Cat. No.	Diameter	Face Angle	Type	Price Each
14049	1 3/4"	45°	Hard	\$1.85	14216	1 1/4"	45°	Soft	\$1.85	14378	2 5/8"	30°	Finish	\$3.00
14050	2 1/2"	45°	Hard	2.30	14217	1 1/4"	45°	Hard	1.85	14379	2 3/4"	30°	Finish	3.00
14056	1 1/2"	45°	Hard	1.85	14218	1 3/4"	30°	Hard	1.85	14380	2 1/8"	30°	Finish	3.00
14063	1 5/8"	45°	Soft	1.85	14219	1 1/2"	30°	Hard	1.85	14381	3"	30°	Finish	3.00
14064	2"	45°	Soft	1.85	14239	2 3/8"	45°	Hard	3.00	14382	1 1/2"	45°	Finish	1.85
14084	1 1/2"	45°	Soft	1.85	14243	3"	45°	Hard	3.00	14383	1 5/8"	45°	Finish	1.85
14085	1 3/4"	45°	Soft	1.85	14268	1 7/8"	30°	Soft	1.85	14384	1 3/4"	45°	Finish	1.85
14086	1 7/8"	45°	Soft	1.85	14269	2 1/8"	30°	Hard	3.00	14385	1 7/8"	45°	Finish	1.85
14087	2 1/8"	45°	Soft	2.30	14270	2 5/8"	20°	Hard	3.00	14386	2"	45°	Finish	1.85
14088	2 1/4"	45°	Soft	2.30	14271	2 3/4"	20°	Hard	3.00	14387	2 1/4"	45°	Finish	2.30
14089	2 1/2"	45°	Soft	2.30	14272	2 7/8"	20°	Hard	3.00	14388	2 1/2"	45°	Finish	2.30
14090	1 3/4"	30°	Soft	1.85	14273	3"	20°	Hard	3.00	14389	2 3/2"	45°	Finish	2.30
14091	2"	30°	Soft	1.85	14274	2 3/4"	20°	Soft	3.00	14390	2 3/8"	45°	Finish	3.00
14092	1 1/2"	20°	Soft	1.85	14275	2 3/4"	20°	Soft	3.00	14391	2 3/4"	45°	Finish	3.00
14093	1 5/8"	20°	Soft	1.85	14276	2 7/8"	20°	Soft	3.00	14392	2 7/8"	45°	Finish	3.00
14094	1 3/4"	20°	Soft	1.85	14277	3"	20°	Soft	3.00	14393	3"	45°	Finish	3.00
14095	1 7/8"	20°	Soft	1.85	14278	2 1/8"	30°	Soft	2.30	14413	1 1/4"	30°	Finish	1.85
14096	2"	20°	Soft	1.85	14279	2 3/4"	30°	Soft	2.30	14414	1 3/4"	45°	Finish	1.85
14097	2 1/4"	20°	Soft	2.30	14280	2 1/2"	30°	Soft	2.30	16929	2 3/8"	45°	Soft	2.30
14098	2 1/4"	20°	Soft	2.30	14281	2 5/8"	30°	Soft	3.00	16951	2 3/8"	45°	Hard	2.30
14099	2 1/2"	20°	Soft	2.30	14282	2 3/4"	30°	Soft	3.00	18540	1 3/8"	45°	Hard	1.85
14100	1 5/8"	45°	Hard	1.85	14283	2 7/8"	30°	Soft	3.00	18541	1 3/8"	45°	Soft	1.85
14101	1 7/8"	45°	Hard	1.85	14284	3"	30°	Soft	3.00	18542	1 3/8"	45°	Finish	1.85
14102	2"	45°	Hard	1.85	14285	2 5/8"	45°	Soft	3.00	21473	3 1/2"	45°	Hard	3.85
14103	2 1/8"	45°	Hard	2.30	14286	2 7/8"	45°	Soft	3.00	21474	3 1/2"	45°	Soft	3.85
14104	2 1/4"	45°	Hard	2.30	14287	1 5/8"	30°	Hard	1.85	21475	3 1/2"	45°	Finish	3.85
14105	1 3/4"	30°	Hard	1.85	14288	1 7/8"	30°	Hard	1.85	23666	1 5/8"	20°	Soft	1.85
14106	2"	30°	Hard	1.85	14289	2 1/8"	30°	Hard	2.30	23667	1 3/8"	20°	Hard	1.85
14107	1 1/2"	20°	Hard	1.85	14290	2 1/4"	30°	Hard	2.30	23668	2 3/8"	20°	Soft	2.30
14108	1 5/8"	20°	Hard	1.85	14291	2 1/2"	30°	Hard	2.30	23669	2 3/8"	20°	Hard	2.30
14109	1 3/4"	20°	Hard	1.85	14292	2 5/8"	30°	Hard	3.00	23670	2 3/8"	45°	Finish	2.30
14110	1 7/8"	20°	Hard	1.85	14293	2 3/4"	30°	Hard	3.00	23957	1 13/16"	45°	Soft	1.85
14111	2"	20°	Hard	1.85	14294	3"	30°	Hard	3.00	25634	3 1/2"	30°	Finish	3.85
14112	2 1/8"	20°	Hard	2.30	14295	2 1/8"	45°	Hard	3.00	25635	2 3/8"	30°	Soft	2.30
14113	2 1/4"	20°	Hard	2.30	14370	1 1/2"	30°	Finish	1.85	25636	2 3/8"	30°	Finish	2.30
14114	2 1/2"	20°	Hard	2.30	14371	1 5/8"	30°	Finish	1.85	25670	1 5/8"	30°	Hard	1.85
14153	2 3/4"	45°	Soft	3.00	14372	1 3/4"	30°	Finish	1.85	25671	1 3/8"	30°	Soft	1.85
14154	3"	45°	Soft	3.00	14373	1 7/8"	30°	Finish	1.85	25672	1 3/8"	30°	Finish	1.85
14197	1 1/4"	30°	Soft	1.85	14374	2"	30°	Finish	1.85	25676	1 3/4"	20°	Soft	1.85
14198	1 1/2"	30°	Soft	1.85	14375	2 1/8"	30°	Finish	2.30	26527	3 1/2"	30°	Soft	3.85
14199	1 5/8"	30°	Soft	1.85	14376	2 1/4"	30°	Finish	2.30					
14200	2 3/4"	45°	Hard	3.00	14377	2 1/2"	30°	Finish	2.30					



Black & Decker

ELECTRIC
TOOL
HEADQUARTERS

Carbon Removing Accessories

Carbon Removing Brushes

Made of tempered steel wire; used with $\frac{1}{4}$ " Drills, quickly clean carbon from cylinder heads, top of pistons, valve ports, etc., leaving a burnished surface.



CARBON REMOVING BRUSHES

- No. 21416 Heavy-duty solid wire-filled brush (A) \$.95
- No. 21417 Side flare brush for close corner work (B) 1.40
- No. 21418 Small brush for cleaning valve-guide ports85
- No. 21419 Hollow core, flare bottom brush (C) 1.45

Valve Guide Cleaners

Made of spring wire set spirally about a stem and expanded to give heavy cleaning tension. A few strokes with this Cleaner driven by a $\frac{1}{4}$ " drill thoroughly cleans and polishes the Valve Guide.



VALVE GUIDE
CLEANER

Cat. No.	Minimum Size	Maximum Size	Price	Cat. No.	Minimum Size	Maximum Size	Price
21436	$\frac{1}{4}$ "	to $\frac{9}{32}$ "	\$1.20	21456	$\frac{9}{16}$ "	to $\frac{39}{64}$ "	\$1.75
21441	$\frac{5}{16}$ "	to $\frac{23}{64}$ "	1.20	21460	$\frac{3}{8}$ "	to $\frac{43}{64}$ "	1.90
22810	$1\frac{1}{32}$ "	to $2\frac{5}{64}$ "	1.35	17682	$\frac{3}{4}$ "	to $2\frac{5}{32}$ "	2.25
21445	$\frac{3}{8}$ "	to $2\frac{7}{64}$ "	1.35	15125	Ford V-85		2.25
21449	$\frac{7}{16}$ "	to $3\frac{3}{64}$ "	1.45	22375	Ford V-60		2.50
21453	$\frac{1}{2}$ "	to $3\frac{5}{64}$ "	1.60				



See complete listing of Wire Wheel
Brushes on page 36.

The Black & Decker Guarantee

Every Black & Decker product has been carefully inspected before shipment, and we guarantee to correct any defect caused by faulty material or workmanship. Our obligation assumed under this guarantee is limited to the replacing of any part or parts which prove to our satisfaction, upon examination, to have been defective, and which have not been misused or carelessly handled. The complete unit must be returned to one of our Factory Service Branches or to our Factory, transportation charges prepaid. We reserve the right to decline responsibility where repairs have been made or attempted by others. No other guarantee, written or verbal, on our products is authorized by us.



Black & Decker

ELECTRIC
TOOL
HEADQUARTERS

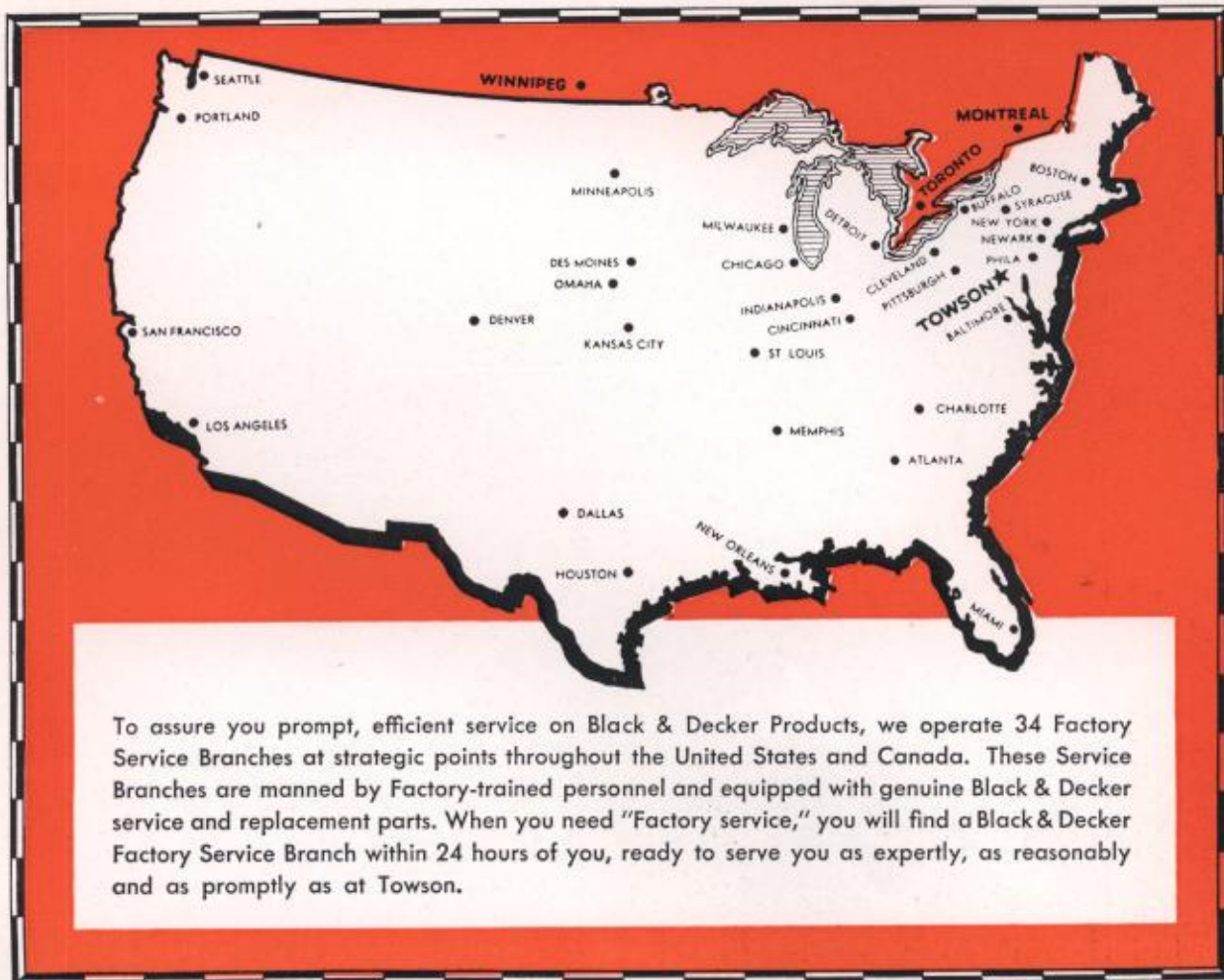

To assure you prompt, efficient service on Black & Decker Products, we operate 34 Factory Service Branches at strategic points throughout the United States and Canada. These Service Branches are manned by Factory-trained personnel and equipped with genuine Black & Decker service and replacement parts. When you need "Factory service," you will find a Black & Decker Factory Service Branch within 24 hours of you, ready to serve you as expertly, as reasonably and as promptly as at Towson.

FACTORY SALES and SERVICE BRANCHES

ATLANTA 3, GEORGIA	316 TECHWOOD DRIVE, N.W.	MEMPHIS 3, TENNESSEE	921 SOUTH THIRD STREET
BALTIMORE 11, MARYLAND	203 WEST 28th STREET	MIAMI 37, FLORIDA	3900 N.W. SEVENTH AVENUE
BOSTON 35, MASSACHUSETTS	12 MARKET STREET (BRIGHTON)	MILWAUKEE 13, WISCONSIN	6301 BLUE MOUND RD.
BUFFALO 9, NEW YORK	881 W. DELAVAN AVENUE	MINNEAPOLIS 8, MINNESOTA	2815 NICOLLET AVENUE
CHARLOTTE 6, NORTH CAROLINA	800 N. COLLEGE STREET	NEWARK 5, NEW JERSEY	611 McCARTER HIGHWAY
CHICAGO 7, ILLINOIS	1100 W. JACKSON BLVD.	NEW ORLEANS 12, LOUISIANA	639 DRYADES STREET
CINCINNATI 2, OHIO	1094 GILBERT AVENUE	NEW YORK 13, NEW YORK	55 VANDAM STREET
CLEVELAND 15, OHIO	2118 E. 21st STREET	OMAHA 2, NEBRASKA	2218 LEAVENWORTH STREET
DES MOINES 12, IOWA	2811 INGERSOLL AVENUE	PHILADELPHIA 3, PENNSYLVANIA	333 N. 20th STREET
DALLAS 12, TEXAS	1808 N. INDUSTRIAL BLVD.	PITTSBURGH 13, PENNSYLVANIA	4740 BAUM BOULEVARD
DENVER 4, COLORADO	1010 BANNOCK STREET	PORTLAND 9, OREGON	1640 N.W. JOHNSON STREET
DETROIT 2, MICHIGAN	302B EAST GRAND BOULEVARD	SAN FRANCISCO 3, CALIFORNIA	1090 BRYANT STREET (AT 9th)
HOUSTON 3, TEXAS	409 VELASCO STREET	SEATTLE 9, WASHINGTON	434 EIGHTH AVENUE, N.
INDIANAPOLIS 2, INDIANA	1125 WEST 16th STREET	ST. LOUIS 10, MISSOURI	615 S. VANDEVENTER STREET
KANSAS CITY 8, MISSOURI	1603 OAK STREET	SYRACUSE 3, N. Y.	2140 ERIE BLVD., E.
LOS ANGELES 7, CALIFORNIA	2432 S. BROADWAY		

BLACK & DECKER MFG. CO., Limited

80-86 Fleet St., Toronto 2, Ont., Canada

7865 St. Lawrence Blvd., Montreal 14, P. Q., Canada

955 Portage Ave., Winnipeg, Manitoba, Canada

BLACK & DECKER, Limited

Harmondsworth, Middlesex, England

BLACK & DECKER (A'asia), PTY., Ltd.

4 Bridge Road, Glebe, Sydney, Australia

BLACK & DECKER, S. A.

Claudio Bernard, 180-F, Mexico, D. F., Mexico

BLACK & DECKER, Inc.

Rua Oriente 768, Sao Paulo, Brazil

THE BLACK & DECKER MFG. CO. — TOWSON 4, MARYLAND, U. S. A.



PORTABLE ELECTRIC TOOLS

DRILLS • HOLE SAWS • DRILL STANDS
SCREW DRIVERS • NUT RUNNERS • TAPPERS
SHEARS • BENCH GRINDERS • DIE
GRINDERS • PORTABLE GRINDERS • SANDERS
BUFFERS • HAMMERS • SAWS • GLUE POTS
INDUSTRIAL VACUUM CLEANERS • VALVE REFACERS
WIRE WHEEL BRUSHES • VALVE SEAT GRINDERS
ATTACHMENTS & SUPPLIES

DISTRIBUTED
BY
W. J. FOSS COMPANY
112-114 THE BROADWAY
SPRINGFIELD 3, MASS.