

◆ PRECISION INSTRUMENTS FOR TEST AND MEASUREMENT ◆

# DE-5000

## Portable, Full-Featured LCR Meter

### User and Service Manual



**IET LABS, INC.**  
534 Main Street, Westbury, NY 11590

www.ietlabs.com  
TEL: (516) 334-5959 • (800) 899-8438 • FAX: (516) 334-5988



---

**IET LABS, INC.**

534 Main Street, Westbury, NY 11590

[www.ietlabs.com](http://www.ietlabs.com)

TEL: (516) 334-5959 • (800) 899-8438 • FAX: (516) 334-5988

◆ PRECISION INSTRUMENTS FOR TEST AND MEASUREMENT ◆

# DE-5000

## Portable, Full-Featured LCR Meter

### User and Service Manual



Copyright © 2011 IET Labs, Inc.  
Visit [www.ietlabs.com](http://www.ietlabs.com) for manual revision updates

DE-5000 im/October 2011



**IET LABS, INC.**

534 Main Street, Westbury, NY 11590

[www.ietlabs.com](http://www.ietlabs.com)  
TEL: (516) 334-5959 • (800) 899-8438 • FAX: (516) 334-5988

◆ PRECISION INSTRUMENTS FOR TEST AND MEASUREMENT ◆



**IET LABS, INC.**

534 Main Street, Westbury, NY 11590

[www.ietlabs.com](http://www.ietlabs.com)

TEL: (516) 334-5959 • (800) 899-8438 • FAX: (516) 334-5988

## **WARRANTY**

We warrant that this product is free from defects in material and workmanship and, when properly used, will perform in accordance with applicable IET specifications. If within one year after original shipment, it is found not to meet this standard, it will be repaired or, at the option of IET, replaced at no charge when returned to IET. Changes in this product not approved by IET or application of voltages or currents greater than those allowed by the specifications shall void this warranty. IET shall not be liable for any indirect, special, or consequential damages, even if notice has been given to the possibility of such damages.

THIS WARRANTY IS IN LIEU OF ALL OTHER WARRANTIES, EXPRESSED OR IMPLIED, INCLUDING BUT NOT LIMITED TO, ANY IMPLIED WARRANTY OF MERCHANTABILITY OR FITNESS FOR ANY PARTICULAR PURPOSE.



## **WARNING**



OBSERVE ALL SAFETY RULES  
WHEN WORKING WITH HIGH VOLTAGES OR LINE VOLTAGES.

**Dangerous voltages may be present inside this instrument. Do not open the case  
Refer servicing to qualified personnel**

### **HIGH VOLTAGES MAY BE PRESENT AT THE TERMINALS OF THIS INSTRUMENT**

WHENEVER HAZARDOUS VOLTAGES (> 45 V) ARE USED, TAKE ALL MEASURES TO  
AVOID ACCIDENTAL CONTACT WITH ANY LIVE COMPONENTS.

USE MAXIMUM INSULATION AND MINIMIZE THE USE OF BARE  
CONDUCTORS WHEN USING THIS INSTRUMENT.

**Use extreme caution when working with bare conductors or bus bars.**

WHEN WORKING WITH HIGH VOLTAGES, POST WARNING SIGNS AND  
KEEP UNREQUIRED PERSONNEL SAFELY AWAY.



## **CAUTION**



DO NOT APPLY ANY VOLTAGES OR CURRENTS TO THE TERMINALS OF THIS  
INSTRUMENT IN EXCESS OF THE MAXIMUM LIMITS INDICATED ON  
THE FRONT PANEL OR THE OPERATING GUIDE LABEL.

# Table of Contents

<b>Chapter 1: Introduction .....</b>	<b>1</b>
1.1. Overview .....	1
1.2. Introduction to measuring principles.....	2
1.2.1. What is impedance .....	2
1.2.2. Measuring impedance.....	4
1.3. Equivalent circuit .....	6
1.4. Instrument layout.....	7
1.5. LCD display layout .....	10
<b>Chapter 2: Operation.....</b>	<b>12</b>
2.1. How to obtain optimum precision .....	12
2.2. Default settings.....	12
2.3. Zeroing the meter .....	14
2.4. Attaching DUT's to the meter .....	17
2.5. Primary measurements and functions.....	19
2.5.1. Measuring inductance, capacitance, and resistance .....	19
2.5.2. Measuring dissipation, quality, ESR, and phase angle...22	
2.5.3. Sorting components.....	24
2.5.4. Making relative measurements.....	26
2.6. Additional settings.....	30
2.6.1. Selecting test frequency.....	30
2.6.2. Making measurements in series and parallel .....	32

2.7. Additional features .....	33
2.7.1. Connecting to a PC.....	33
2.7.2. Using the backlight.....	35
2.7.3. Holding a reading on the display .....	35
2.8. Replacing Batteries .....	36
<b>Chapter 3: Specifications.....</b>	<b>37</b>
3.1. General specifications .....	37
3.2. Accuracy specifications.....	39
3.3. Ordering information.....	42



# Chapter 1: Introduction

## 1.1. Overview

The DE-500 is a portable, high-performance LCR meter that is full-featured yet cost effective. It measures in true 4-wire Kelvin mode and rivals the capabilities and options of many of its bench counterparts. It measures:

- Ls/Lp** -- Series and parallel inductance
- Cs/Cp** -- Series and parallel capacitance
- Rs/Rp** -- Series and parallel resistance (ac)
- Rdc/Rp** -- Series and parallel resistance (dc)
- ESR/Rp** -- Series and parallel equivalent resistance
- D** -- Dissipation factor
- Q** -- Quality factor
- Θ** -- Phase angle

This LCR meter can transfer data to a PC via a standard, fully isolated, optical IR-USB interface. It also features a **Sorting** mode, allowing users to quickly sort components.

DE-5000 has automatic LCR selection. This allows the user to measure the **L/C/R** components in **Auto LCR** mode without having to select the type of measurement.

To accommodate various test requirements, the DE-5000 offers selectable test frequencies: 100 Hz / 120 Hz / 1 kHz / 10 kHz / 100 kHz.

The unit is powered by a standard 9V battery. For additional convenience, it may also use an optional ac adapter (DE-5000-AC).

To transfer data to a PC, the unit comes with a built-in IR interface. IET offers an optional Data Transfer Kit (DE-5000-DTK). This kit includes: IR-USB interface adapter, a USB cable, and a CD with software for the PC.

## **1.2. Introduction to measuring principles**

### **1.2.1. What is impedance**

Impedance (**Z**) consists of resistance (real part) and reactance (imaginary part). Series impedance (**Zs**) can be defined as a combination of series resistance (**Rs**) and series reactance (**Xs**). It can be represented mathematically as magnitude  $|Z| = \sqrt{(\mathbf{R}s^2 + \mathbf{X}s^2)}$  at a phase angle  $\Theta$ .

Imaginary axis (series mode)

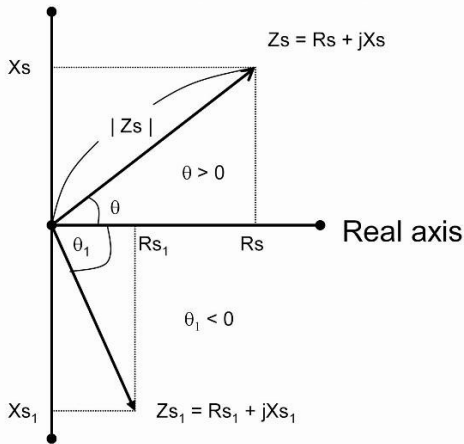

$$\mathbf{Z_s = R_s + jX_s \text{ or } |Z_s| \angle \Theta}$$

$$\mathbf{R_s = |Z_s| \cos \Theta}$$

$$\mathbf{X_s = |Z_s| \sin \Theta}$$

$$\mathbf{X_s/R_s = \tan \Theta}$$

$$\mathbf{\Theta = \tan^{-1}(X_s/R_s)}$$

There are two types of reactance. One is inductive reactance –  $\mathbf{X_L}$ , and the other is capacitive reactance –  $\mathbf{X_C}$ .

If  $\mathbf{\Theta > 0}$ , the reactance is inductive. If  $\mathbf{\Theta < 0}$ , the reactance is capacitive.

The inductive and capacitive reactances ( $\mathbf{X_L}$  and  $\mathbf{X_C}$ ) can be defined as:

$$\mathbf{X_L = 2\pi fL}$$

$$\mathbf{X_C = 1 \div (2\pi fC)}$$

Where:

$\mathbf{L}$  = Inductance

$\mathbf{C}$  = Capacitance

$f$  = signal frequency)

### 1.2.2. Measuring impedance

Impedance can be measured in series or in parallel. In parallel mode, impedance can be represented as reciprocal of admittance (**Y**). The admittance can be defined as  $\mathbf{Y} = \mathbf{G} + j\mathbf{B}$ , where:

**G** = Conductance

**B** = Susceptance

Series impedance

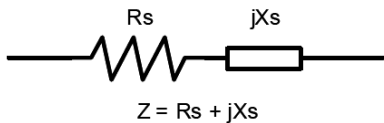

Parallel admittance

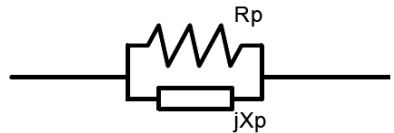

$$\mathbf{Y} = 1/\mathbf{Z} = 1/R_p + 1/jX_p = \mathbf{G} + j\mathbf{B}$$

**Rs** = Series resistance

**Xs** = Series reactance

**Cs** = Series capacitance

**Ls** = Series Inductance

**Rp** = Parallel resistance

**Xp** = Parallel reactance

**Cp** = Parallel capacitance

**Lp** = Parallel inductance

To understand the ratio of resistance and reactance, it is important to consider two factors: quality factor (**Q**) and dissipation factor (**D**). Usually **Q** is used when measuring inductance and **D** is used when measuring capacitance. **D** is defined as the reciprocal of **Q**.

$$\mathbf{Q} = 1/\mathbf{D} = \tan\Theta$$

$$\mathbf{Q} = \mathbf{X}_s/\mathbf{R}_s = 2\pi f \mathbf{L}_s/\mathbf{R}_s = 1/2\pi f \mathbf{C}_s \mathbf{R}_s$$

$$\mathbf{Q} = \mathbf{B}/\mathbf{G} = \mathbf{R}_p/|\mathbf{X}_p| = \mathbf{R}_p/2\pi f \mathbf{L}_p = 2\pi f \mathbf{C}_p \mathbf{R}_p$$

Both **Rs** and **Rp** are part of the equivalent circuit of capacitors and inductors. When measuring capacitance and inductance, it is best to use the settings as shown in the table below.

	<b>Value</b>	<b>Setting</b>
Capacitance	Low	Parallel
	High	Series
Inductance	Low	Series
	High	Parallel

### 1.3. Equivalent circuit

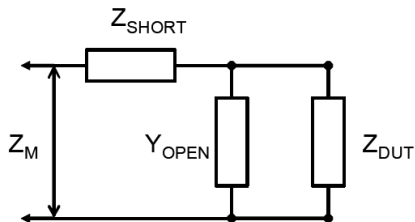

$$Z_{DUT} = \frac{Z_M - Z_{SHORT}}{1 - (Z_M - Z_{SHORT})Y_{OPEN}}$$

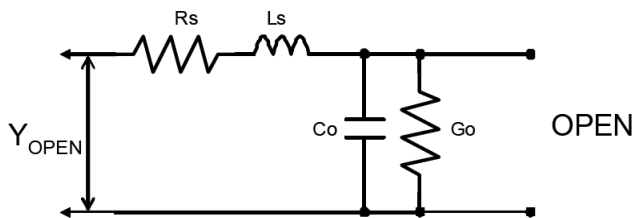

If  $R_s + j\omega L_s \ll 1 / (G_o + j\omega C_o)$   
 $Y_{OPEN} = G_o + j\omega C_o$

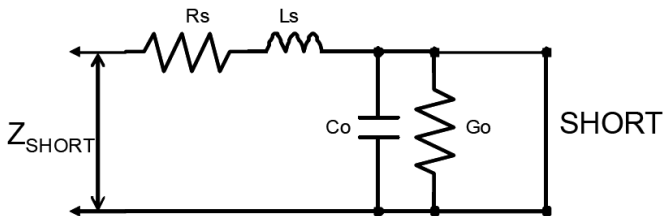

$$Z_{SHORT} = R_s + j\omega L_s$$

# 1.4. Instrument layout

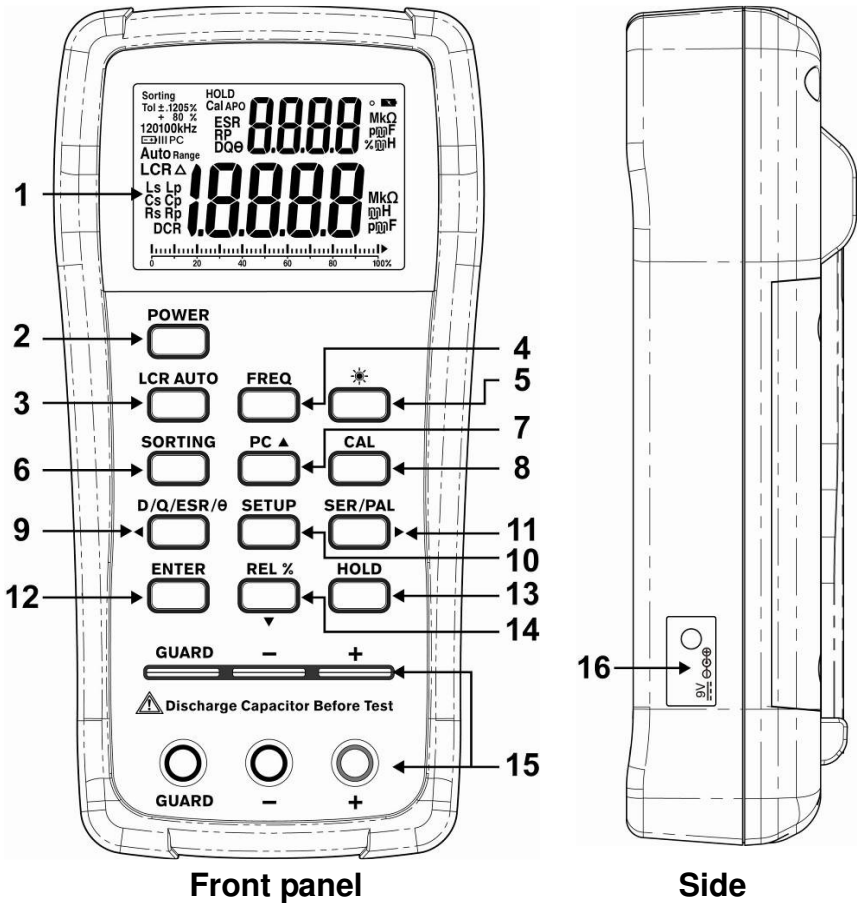

GUARD provides a shield to reduce noise for device under test (DUT), test leads, and other equipment.

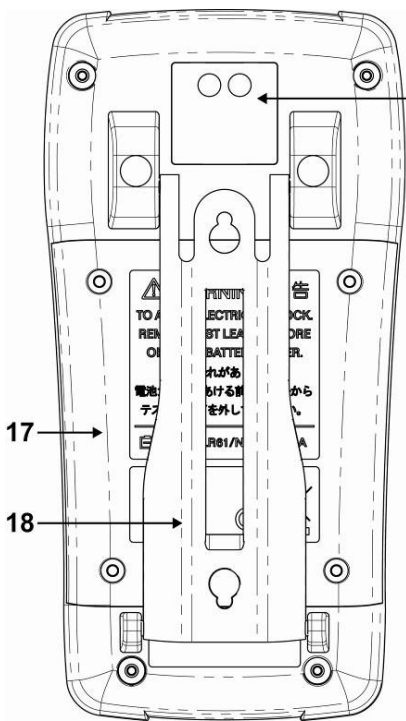

**Rear**

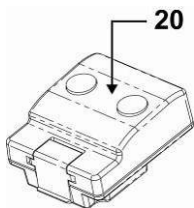

**IR- USB interface  
(optional)**

**21. TL-21**  
Alligator -lead test-lead adapter  
(4-wire joined at alligator clips)

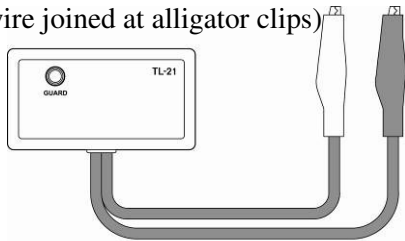

**22. TL-22**  
SMD tweezers, 4-wire  
(optional)

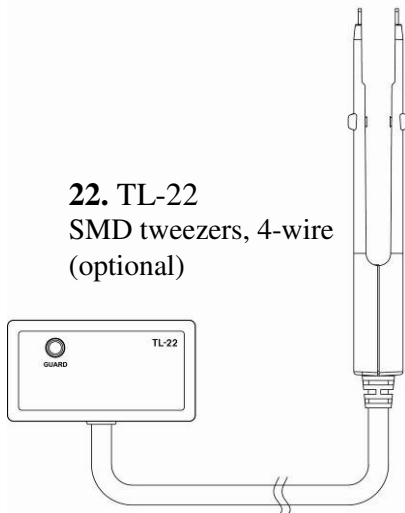

**23. TL-23**  
Guard Line

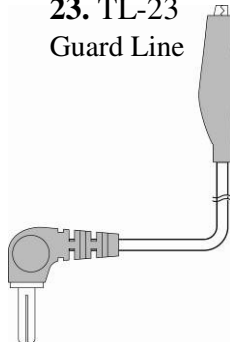



1.	<b>LCD display</b>	
2.	POWER	Turns the instrument on/off.
3.	LCR AUTO	<b>LCR auto</b> mode, Inductance, Capacitance, Resistance and DC resistance measurement selection
4.	FREQ	Testing frequency selection
5.	☼	Backlight display
6.	SORTING	Sorting mode control
7.	PC ▲	UART output control
8.	CAL	Open/Short calibration mode
9.	D/Q/ESR/Θ	<b>D/Q/ ESR/Θ</b> parameters selection
10.	SETUP	Setup menu control (in sorting mode )
11.	SER/PAL	Series and Parallel selection
12.	ENTER	Setup menu control (in sorting mode )
13.	REL%	Relative mode
14.	HOLD	Data hold
15.	Input sockets and Terminals (4-terminal)	
16.	AC adapter plug	
17.	Battery cover	
18.	Tilt-Stand	
19.	IR Slot	
20.	IR-USB adapter (optional)	
21.	TL-21 Alligator-clip test-lead adapter	
22.	TL-22 SMD tweezers (optional)	
23.	TL-23 Guard Line	

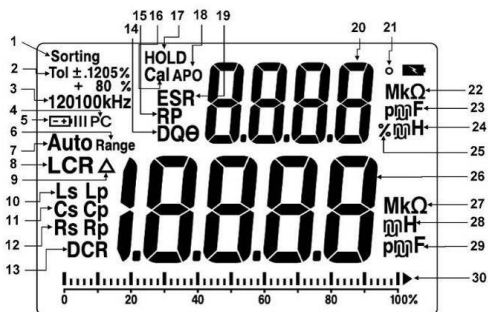

## 1.5. LCD display layout



1.	<b>Sorting</b>	Sorting function is enabled
2.	<b>Tol</b>	Tolerance indicator in sorting mode : $\pm 0.25\%$ , $\pm 0.5\%$ , $\pm 1\%$ , $\pm 2\%$ , $\pm 5\%$ , $\pm 10\%$ , $\pm 20\%$ , & $+80\%-20\%$
3.	<b>kHz</b>	Testing frequency indicator: 1kHz, 10kHz, 100kHz, 100Hz & 120Hz
4.	<b>PC</b>	PC connection is active
5.		Battery capacity indicator
6.	<b>Range</b>	Range selection is enabled on setup menu of sorting mode
7.	<b>Auto</b>	Auto range for <b>L</b> , <b>C</b> or <b>R</b> measurements
8.	<b>LCR</b>	Checking for <b>L/C/R</b> mode automatically
9.	<b>Δ</b>	Relative function is enabled
10.	<b>Ls/Lp</b>	Inductance in series or parallel mode is active
11.	<b>Cs/Cp</b>	Capacitance in series or parallel mode is active
12.	<b>Rs/Rp</b>	ac resistance in series or parallel mode is active
13.	<b>DCR</b>	dc resistance mode is selected

14.	D/Q/Θ	Dissipation factor, Quality factor or Phase angle is active for L/C measurement mode
15.	Rp	ac Resistance in parallel mode is active
16.	Cal	Open/Short calibration mode
17.	HOLD	Data Hold
18.	APO	Auto power off mode
19.	ESR	Series equivalent resistance mode
20.	8888	Secondary Display
21.	°	Phase angle
22.	MkΩ	Unit for Resistance ( Ω, kΩ and MΩ ) – on secondary display
23.	pμF	Unit for Capacitance ( pF, nF, μF and mF ) – on secondary display
24.	μH	Unit for Inductance ( μH, mH and H ) – on secondary display
25.	%	The percentage display in relative mode – on secondary display
26.	18888	Primary Display
27.	MkΩ	Unit for Resistance ( Ω, kΩ and MΩ ) – on primary display
28.	μH	Unit for Inductance ( μH, mH and H ) – on primary display
29.	pμF	Unit for Capacitance ( pF, nF, μF and mF ) – on primary display
30.		Bar-graph display

#### Special Indication Characters

	Indicates short calibration
	Indicates open calibration

## Chapter 2: Operation

### 2.1. How to obtain optimum precision

To access optimum precision for all **L**, **C**, and **R** measurements, especially at the highest and the lowest ranges, zero the instrument before use (pages 16-18).

To secure the specified accuracy, connect the device under test (DUT) to the measuring socket, or use either TL-21 (standard accessory) or TL-22 (optional accessory).

If you are using test leads other than the ones specified above, use 4-wire leads and avoid using long lead wires to reduce measurement errors.

### 2.2. Default settings

When the power is turned on, the monitor displays all symbols for 2 seconds as shown below.

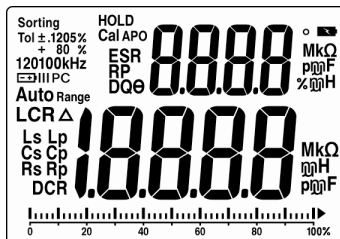



When the meter is powered by the battery, it is in an automatic-power-off mode. **APO** is shown on the display. In this mode, if the unit is inactive for 5 minutes, it shuts itself off. First, the buzzer beeps three times to remind the user, then **OFF** is displayed on the monitor as shown below while the unit powers down.

Note that when the unit is powered via an ac adapter, the automatic-power-off mode is inactive.



The default settings for the meter set LCR in auto mode and test frequency at 1 kHz.

The battery condition is continuously displayed.  means that the battery capacity is full.  means that battery power is low and the battery needs to be replaced.

The LCR meter uses beeps to indicate whether a particular key has a function in a given mode. If a functional key is pressed, there is a single beep. If a non-functional key is pressed, there is a dual beep.

### 2.3. Zeroing the meter

Zeroing the instrument gets better accuracy for impedance measurements. The purpose of this procedure is to reduce the parasitic effect of the test fixture.

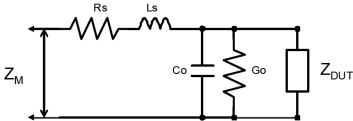

$Z_M$  is the total impedance measured on the device under test (DUT) by a test fixture which has some parasitic impedance.

$$Z_M = (R_s + j\omega L_s) + ((G_o + j\omega C_o)^{-1} \parallel Z_{DUT})$$

$Z_{DUT}$  is the target impedance user wants to measure. It is necessary to use the zeroing process to cancel the effect of  $R_s + j\omega L_s$  and  $G_o + j\omega C_o$ .

Ex. Operation for open and short calibration with TL-21

Ex. Operation for open and short calibration with .TL-22

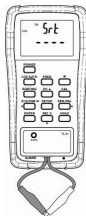

Open Cal.

Short Cal.

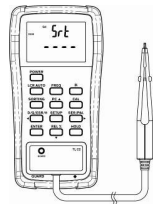
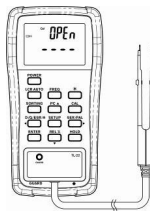

Open Cal.

Short Cal.

To zero the meter, proceed as follows:

1. Make sure the leads are completely disconnected.
2. Press the **CAL** key for 2 seconds.

The monitor should display **OPEn** as shown below.



3. Pres the **CAL** key again.

The unit should begin a countdown as it performs OPEN calibration.



After the countdown is complete, the monitor should say **PASS** as shown below. If it says fail, the procedure has to be restarted.



4. Connect the test leads for form a short circuit.
5. Press the CAL key again.

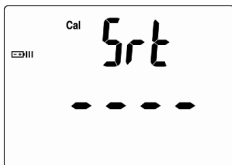

The monitor should display Srt as shown below.

6. Press the CAL key one more time.

The unit should begin a countdown as it performs SHORT calibration.

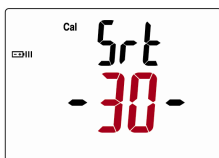

After the countdown is complete, the monitor should say **PASS** as shown below. If it says fail, the procedure has to be restarted.

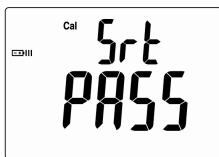

7. Press the CAL key one more time to exit OPEN/SHORT calibration mode.



## 2.4. Attaching DUT's to the meter

Devices under test (DUT's) may be connected to the meter as follows:

- Insert DIP component leads to the sockets directly.

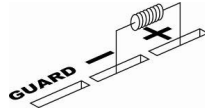

- Attach Alligator-clip test-lead adapter (TL-21)

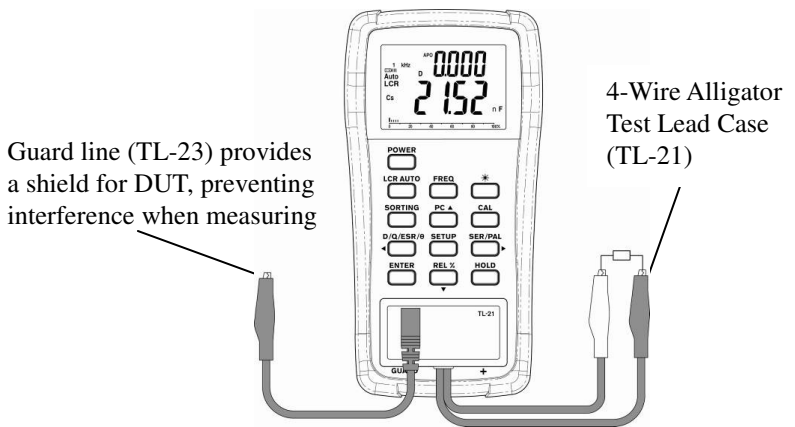

- Attach SMD tweezers (TL-22, optional).

Guard line (TL-23) provides a shield for DUT, preventing interference when measuring high-impedance components

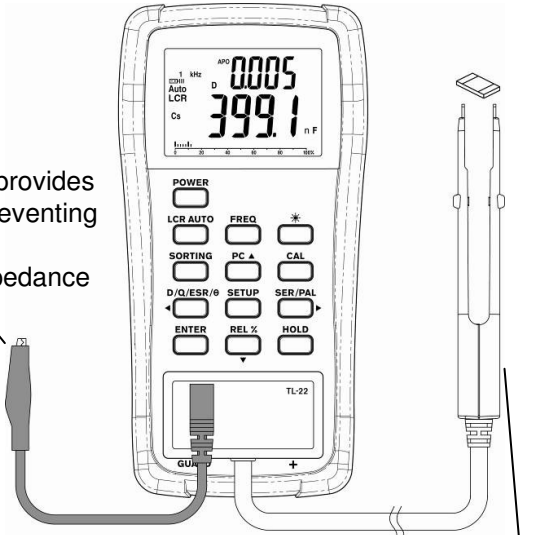

4-wire SMD  
Tweezers  
(TL-22)

## 2.5. Primary measurements and functions

### 2.5.1. Measuring inductance, capacitance, and resistance

The DE-5000 starts out in **Auto LCR** mode which can detect the type of impedance and measure it automatically – either inductance (**L**), capacitance (**C**), or resistance (**R**). Dc resistance (**DCR**) can only be selected manually. The value of impedance is shown in the primary display. The secondary display automatically selects and shows the secondary parameter – either quality factor (**Q**), dissipation factor (**D**), or phase angle (**Θ**). The secondary parameter is based on the **L/C/R** measurement.

When the meter automatically selects impedance automatically, it uses the following procedure:

If **Q** < 0.2, the meter measures resistance.

The parameter on sub-display is **Θ**.

If **Q** ≥ 0.2, the meter measures inductance.

The parameter on sub-display is **Q**.

If **Q** ≥ -0.2, the meter measures capacitance.

The parameter on sub-display is **D**.

If **C** < 5pF. The parameter on sub-display is **Rp**.

Impedance can also be selected manually by pressing the LCR AUTO key. This is what the process would look like:

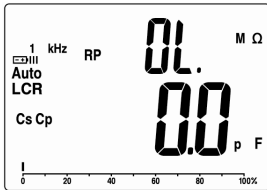

The meter starts out in **Auto LCR** mode.



Press LCR AUTO key.

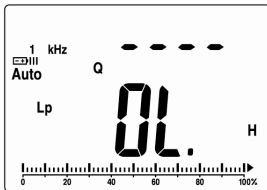

The meter enters **Auto L** mode.

The secondary parameter is **Q**.



Press LCR AUTO key.

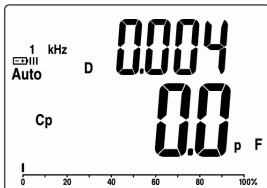

The meter enters **Auto CL** mode.

The secondary parameter is **D**.



Press LCR AUTO key.

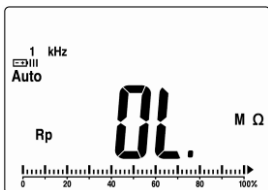

The meter enters **Auto R** mode.

The secondary parameter is blank. (The meter only displays **⊖** automatically in **Auto LCR** mode.)



Press LCR AUTO key.

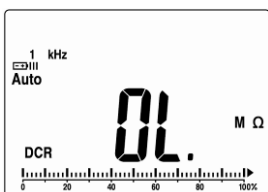

The meter enters **DCR** mode.

The secondary parameter is blank.



Press LCR AUTO key.

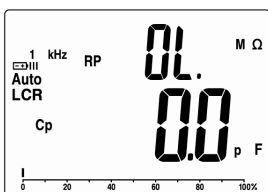

The meter returns to **Auto LCR** mode.

## 2.5.2. Measuring dissipation, quality, ESR, and phase angle

The DE-5000 can measure dissipation factor (**D**), quality factor (**Q**), equivalent series resistance (**ESR**), and phase angle (**Θ**). These readings are shown in the secondary display. To select the appropriate measurement, cycle through the options using the D/Q/ESR/Θ key.

Note: that this function is available in **Auto L** and **Auto C** modes only. In other modes the D/Q/ESR/Θ key is disabled.

Example: In **Auto C** mode

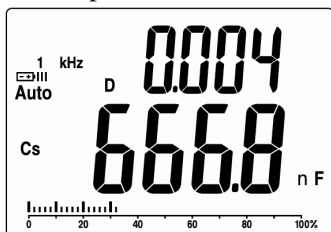

The secondary display shows **D**.



Press D/Q/ESR/Θ key.

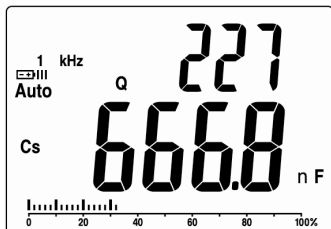

The secondary display shows **Q**.



Press D/Q/ESR/Θ key.

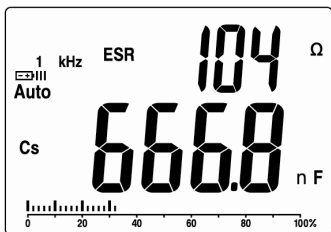

The secondary display shows **ESR**.



Press D/Q/ESR/Θ key.

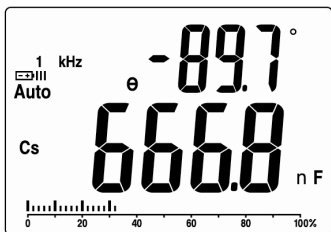

The secondary display shows **Θ**.



Press D/Q/ESR/Θ key.

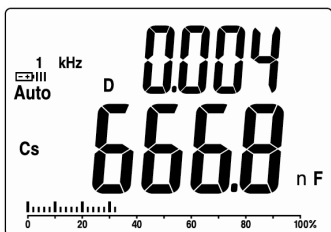

The secondary display returns to **D**.

### 2.5.3. Sorting components

The DE-5000 can sort components into PASS/FAIL categories. Components may be sorted based on resistance, capacitance, or inductance.

**Note:** this function is not available in **Auto LCR** mode. Before using this function, set the meter to either **Auto L** mode, **Auto C** mode, or **Auto R** mode.

To enter the **Sorting** mode, proceed as follows:

1. Zero the meter. Refer to pages 14-16 for details.
2. Press LCR AUTO to cycle through measurement options until the desired impedance type is selected.

**Note:** If you select **Auto LCR**, the sorting function will not work.

3. Connect one of the items that is going to be measured to the test points.
4. Press SORTING, then press SETUP.

**Note:** If you press the SORTING key while the meter is reading outside limits (OL) or while the reading is less than 200 counts, the Sorting function is disabled.



5. To adjust the nominal value, proceed as follows:
- Use ◀ / ▶ keys to adjust the position of the decimal point as necessary. Press ENTER when finished.
  - Use ◀ / ▶ / ▲ / ▼ keys to adjust the digits as necessary. Press ENTER when finished.
6. To adjust tolerance, use ◀ / ▶ keys to cycle through tolerance options until the desired tolerance is reached. Press ENTER when finished.

Available tolerances are:  $\pm 0.25\%$ ,  $\pm 0.5\%$ ,  $\pm 1\%$ ,  $\pm 2\%$ ,  $\pm 5\%$ ,  $\pm 10\%$ ,  $\pm 20\%$ , and  $-20\%+80\%$ .

The components may now be sorted. The primary display will show either **PASS** or **FAIL** as each component is measured. The secondary display will show the value of the measured component, as shown in the sample below.

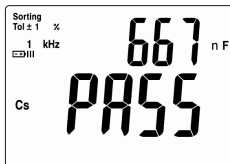

To make adjustments to the nominal value or tolerance, press **SETUP** and repeat steps 5 and 6 above.

To exit the Sorting mode, press **SORTING**.

#### **2.5.4. Making relative measurements**

The DE-5000 meter can make relative measurements. This option is controlled by the **REL%** key. When the Relative mode is active, the display shows the **Δ** symbol.

**Note:** this option is not available in the **Auto LCR** mode. Nor can it be activated when the parameter being tested is outside of meter limits.

The meter uses the following formula to calculate relative measurements:

$$\mathbf{REL\%} = (\mathbf{DCUR} - \mathbf{DREF}) / \mathbf{DREF} * 100\%$$

**REL%** = Percent difference

**DCUR** = Device currently under test

**DREF** = Device used as a standard

To access the Relative mode proceed as follows:

1. Zero the meter. See pages 14-16 for details.
2. Select the parameter to be tested.

**L, C, R, or DCR**

3. Attach the chosen standard to the test points.
4. Press the REL% key.

The meter should now display the **Δ** symbol.

5. Remove the standard and attach a DUT to the test points.

The primary display should show the value of the DUT and the secondary display should show the % difference from the standard.

6. Repeat Step 5 for each DUT.

**Note:** The range for the % difference is -99.9% to 99.9%. If the DUT falls outside that range, the secondary display will show **OL**.

7. To exit, press and hold the REL% key for 2 seconds.

## Example: In Capacitance mode

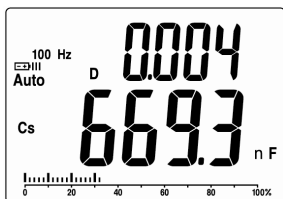

Display shows the measurement reading.  
Ex. 669.3 nF

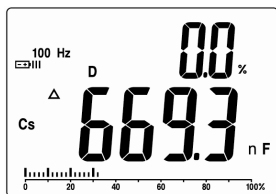

Press REL% key

Δ appears on the screen  
The reading on the display is stored as reference value.  
0.0% is shown on the secondary display since the measured value and the reference are the same at this point.

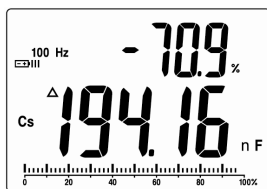

Remove the standard and attach a different device

The new reading is shown on the primary display.  
The % difference is shown on the secondary display.



Remove the current DUT device under test and insert another.

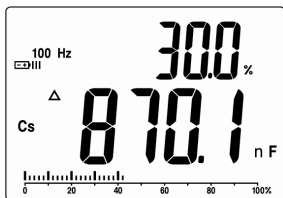

The new reading is shown on the primary display.  
 The % difference is shown on the secondary display.



Press REL% key again

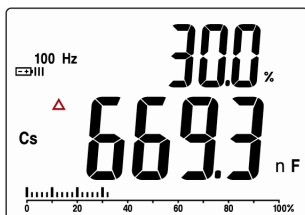

Δ flashes on the screen, and the reference value shows on primary display.

## 2.6. Additional settings

### 2.6.1. Selecting test frequency

The DE-5000 meter can test at the following frequencies: 100 Hz, 120 Hz, 1 kHz, 10 kHz, and 100 kHz. The default frequency setting is 1 kHz. To cycle through the available frequencies, pres the **FREQ** key.

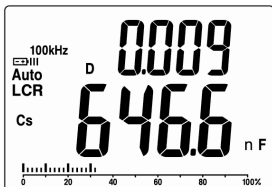
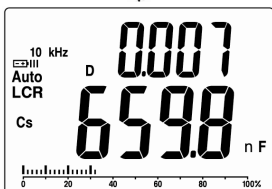
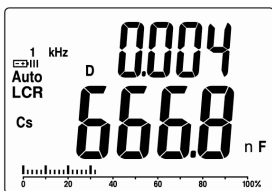

The default test frequency is 1kHz.

Press **FREQ** key.

The testing frequency is now 10kHz.

Press **FREQ** key.

The test frequency is now 100kHz.

Press **FREQ** key.

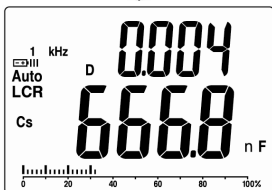
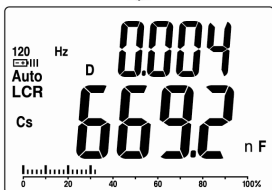
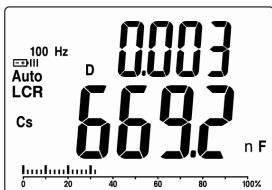

The test frequency is now 100Hz.

Press **FREQ** key.

The test frequency is now 120Hz.

Press **FREQ** key.

The test frequency returns to 1 kHz.

**Note:** test frequency affects the accuracy of the reading. See accuracy charts on pages 35-36.

The LCR impedance scale ranges are based on the test frequency.

## 2.6.2. Making measurements in series and parallel

The DE-5000 meter can make measurements in series or parallel. To select the appropriate option, press the SER/PAL key.

**Note:** this function is available in **Auto L**, **Auto C**, and **Auto R** modes only. In other modes the SER/PAL key is disabled.

Example: In **Auto C** mode

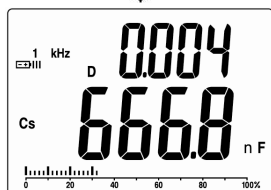
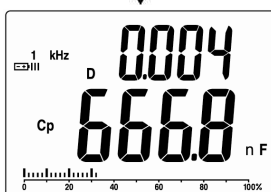
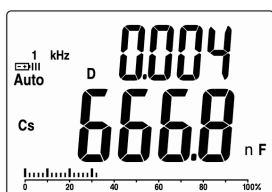

The default setting for capacitance is in series mode. The display shows **Cs**.

Press SER/PAL key.

The meter switches to parallel mode. The display shows **Cp**.

Press SER/PAL key.

The meter returns to series mode. The display shows **Cs**.



If the user does not select series or parallel modes manually, the meter will do so automatically. The meter automatically selects parallel mode if impedance is more than 100 k $\Omega$ , and series mode if impedance is less than 100 k $\Omega$ .

## 2.7. Additional features

### 2.7.1. Connecting to a PC

The IR slot on the rear of the meter makes it possible to connect to a PC for remote operation and data storage. If you have the optional Data Transfer Kit (DE-5000-DTK), you may connect to a PC as follows:

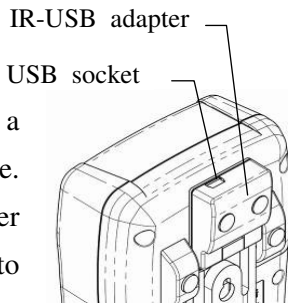

Snap on IR-USB adapter and connect to a PC via a USB cable.

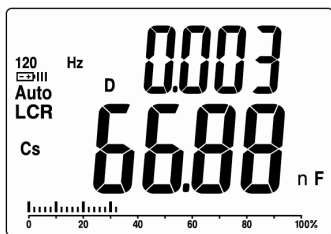

Display shows the measurement reading.



Press PC  $\blacktriangle$  key.

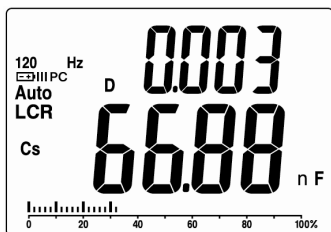

PC communication is active.

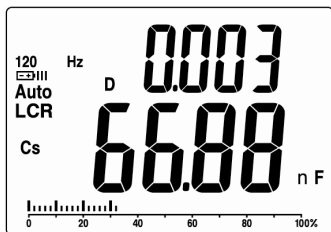

**PC** appears on the display.



Press **PC ▲** key.

PC disappears from the display, and the PC communication is inactive.

### 2.7.2. Using the backlight

To use the back light, press  key. To turn it off, press the  key again.

Note that the backlight is disabled automatically after the meter is inactive for 60 seconds.



### 2.7.3. Holding a reading on the display

Normally, the reading of any given DUT disappears as soon as the device is disconnected from the test points. To hold the reading, press the HOLD button.

**Note:** while in the **Hold** mode, only the  will operate.

To exit this mode, press the HOLD button again.

## 2.8. Replacing Batteries

The DE-5000 is powered by a single, standard, 9 V, alkaline battery. When the battery is at full power, the display shows . When the battery power is running out, the display shows .



**Caution:** To maintain the meter within specifications, replace the battery as soon as the display shows .



To replace batteries, proceed as follows:

1. Turn the meter off and remove any test leads and external adapters.
2. Remove the tilt-stand.
3. Remove the four screws holding the battery cover and take the cover off.
4. Replace the battery with a standard 9 V alkaline battery.

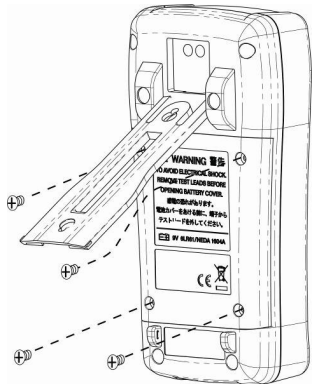

**Caution:** observe correct polarity.

5. Replace the cover and the screws removed in Step 3.

# Chapter 3: Specifications

## 3.1. General specifications

### Parameters measured:

$L_s / L_p / C_s / C_p / R_s / R_p / DCR$  with  $D/Q/\Theta/ESR$  measurement  
Automatic L-C-R selection

### Selectable test model:

Series or Parallel

### Display:

Backlit  
20,000/2,000 count

### Input connection:

4-Wire spring-loaded sockets and binding post jacks  
Accepts normal or shrouded banana plugs

### Automated LCR ranges:

**L:** 20.000  $\mu$ H -- 2000 H  
**C:** 200.00 pF -- 20.00 mF  
**R:** 20.000  $\Omega$  -- 200.0 M $\Omega$   
**DCR:** 200.00  $\Omega$  -- 200.0 M $\Omega$

### Selectable test frequencies:

100 Hz / 120 Hz / 1 kHz / 10 kHz / 100 kHz

### Measurement rate:

1.2/second nominal

**Response time:**

Approx. 1 second/DUT

**Available tolerances for sorting function:**

±0.25%    ±5%

±0.5%    ±10%

±1%        ±20%

±2%        -20/+80%

**Temperature coefficient:**

[0.15 x (specified accuracy)]/°C

0-18°C, 28-50°C

**Test signal level:**

0.5 V<sub>rms</sub> Typical

**Environmental:**

**Operating temperature:** 0°C to 50°C; <70% RH

**Storage temperature:** -20°C to 60°C; <80% RH

**Battery:**

Uses a single, standard 9 V battery

Display includes battery level indicator

**Mechanical:**

**Dimensions:** 18.8 cm H x 9.5 cm W, 5.3 mm D (7.4" x 3.75" x 2")

**Weight:** 350 g (0.75 lb)

## 3.2. Accuracy specifications

Accuracy is specified at 23°C ± 5°C, <75% RH.

All accuracy is specified as ±[(% of reading) + (value of least significant digit)].

For most precise measurements, the meter has to be zeroed first.

### Resistance:

Range	Resolution	100/120Hz	1kHz	10kHz	100kHz
20.000 Ω	0.001 Ω	—	1.0%+3	1.0%+3	2.0%+3
200.00 Ω	0.01 Ω	1.0%+3	0.3%+2	0.3%+2	0.6%+3
2.0000 kΩ	0.0001 kΩ	0.3%+2	0.3%+2	0.3%+2	0.6%+3
20.000 kΩ	0.001 kΩ	0.3%+2	0.3%+2	0.3%+2	0.6%+3
200.00 kΩ	0.01 kΩ	0.5%+2	0.5%+2	0.5%+2	1.0%+3
2.0000 MΩ	0.0001 MΩ	1.0%+3	1.0%+3	1.0%+3	—
2.000MΩ	0.001 MΩ	—	—	—	2.0%+3
20.000 MΩ	0.001 MΩ	2.0%+3	2.0%+3	—	—
20.00 MΩ	0.01 MΩ	—	—	2.0%+3	—
200.0 MΩ	0.1 MΩ	2.0%+3	2.0%+3	—	—

### Capacitance:

Range	Resolution	100/120Hz	1kHz	10kHz	100kHz
200.00 pF	0.01 pF	—	—	1.2%+5	2.0%+5
2000.0 pF	0.1 pF	—	2.0%+3	0.3%+2	0.6%+3
20.000 nF	0.001 nF	2.0%+3	0.3%+2	0.3%+2	0.6%+3
200.00 nF	0.01 nF	0.3%+2	0.3%+2	0.3%+2	0.6%+3
2000.0 nF	0.1 nF	0.3%+2	0.3%+2	0.6%+2	2.0%+5
20.000 μF	0.001 μF	0.3%+2	0.6%+2	1.2%+5	—
20.00 μF	0.01 μF	—	—	—	3.0%+5 (10μF max.)
200.00 μF	0.01 μF	0.6%+2	1.0%+3	—	—
200.0 μF	0.1 μF	—	—	3.0%+5 (100μF max.)	—
2000.0 μF	0.1 μF	1.0%+3	—	—	—
2000 μF	1 μF	—	1.2%+3	—	—
20.00 mF	0.01 mF	1.2%+3	—	—	—

\*If reading <2000, unit on display is pF

## Inductance:

Range	Resolution	100/120Hz	1kHz	10kHz	100kHz
20.000 $\mu$ H	0.001 $\mu$ H	—	—	—	2.5%+5
200.00 $\mu$ H	0.01 $\mu$ H	—	—	1.2%+5	0.6%+3
2000.0 $\mu$ H	0.1 $\mu$ H	—	2.0%+5	0.6%+3	0.6%+3
20.000 mH	0.001 mH	1.2%+5	1.0%+5	0.3%+2	0.6%+3
200.00 mH	0.01 mH	0.3%+2	0.6%+3	0.3%+2	1.2%+5
2000.0 mH	0.1 mH	0.3%+2	0.3%+2	0.6%+3	—
20.000 H	0.001 H	0.3%+2	0.6%+3	1.2%+5	—
200.0 H	0.1 H	0.6%+3	1.2%+5	—	—
2.000 kH	0.001 kH	1.2%+5	—	—	—

\*If reading <2000, unit on display is  $\mu$ H

## DCR:

Range	Resolution	Accuracy
200.00 $\Omega$	0.01 $\Omega$	1.0%+3
2.0000 k $\Omega$	0.0001 k $\Omega$	0.2%+2
20.000 k $\Omega$	0.001 k $\Omega$	0.2%+2
200.00 k $\Omega$	0.01 k $\Omega$	0.5%+2
2.0000 M $\Omega$	0.0001 M $\Omega$	1.0%+3
20.000 M $\Omega$	0.001 M $\Omega$	2.0%+3
200.0 M $\Omega$	0.1 M $\Omega$	2.0%+3

## Accuracy v.s. Resistance ( $Z_{DUT}$ ):

	DCR	100/120Hz	1kHz	10kHz	100kHz
0.1-1 $\Omega$	1.2%+5	1.2%+5	1.2%+5	1.2%+5	2.5%+5
1-10 $\Omega$	0.6%+3	0.6%+3	0.6%+3	0.6%+3	1.2%+5
10-100 k $\Omega$	0.3%+2	0.3%+2	0.3%+2	0.3%+2	0.6%+3
100 k-1 M $\Omega$	0.6%+3	0.6%+3	0.6%+3	0.6%+3	2.5%+5
1 M-20 M $\Omega$	1.2%+5	1.2%+5	1.2%+5	2.5%+5	2.5%+5 (2 M $\Omega$ max.)
>20 M $\Omega$	2.5%+5	2.5%+5	2.5%+5	—	—



### **Adjustment to accuracy (Z) based on dissipation (D) reading:**

$$D > 0.1: Z * \sqrt{(1+D^2)}$$

$$\text{In capacitance mode, } D \leq 0.1: Z_C = 1 \div (2\pi fC)$$

$$\text{In inductance mode, } D \leq 0.1: Z_L = 2\pi fL$$

### **Secondary Parameters Accuracy:**

$A_z$  = impedance (Z) accuracy

$$\text{Definition: } Q = 1/D \text{ \& } R_p = ESR * (1+1/D^2)$$

$$\text{D value accuracy: } D_z = \pm A_z * (1+D)$$

$$\text{ESR accuracy: } R_z = \pm Z_M * A_z (\Omega)$$

ie.,  $Z_M$  = impedance calculated by  $1 \div (2\pi fC)$  or  $2\pi fL$

$$\text{Phase angle } \Theta \text{ accuracy: } \Theta_z = \pm (180/\pi) * A_z (\text{deg})$$

### 3.3. Ordering information

#### DE-5000 Standard Package:

LCR meter	<b>DE-5000-LCR</b>
Carrying case	<b>DE-5000-CS</b>
Alligator-clip test-lead adapter (4-wire joined at the alligator clips)	<b>TL-21</b>
Guard lead	<b>TL-23</b>
Standard 9 V battery	<b>DE-5000-9V</b>
Instruction manual	<b>DE-5000-IM</b>

#### Optional Accessories:

AC adapter	<b>DE-5000-AC</b>
SMD tweezers (4-wire)	<b>TL-22</b>
Data transfer kit	<b>DE-5000-DTK</b>

- IR to USB Interface Adapter
- USB cable
- CD with software for PC



◆ PRECISION INSTRUMENTS FOR TEST AND MEASUREMENT ◆



---

**IET LABS, INC.**

534 Main Street, Westbury, NY 11590

[www.ietlabs.com](http://www.ietlabs.com)

TEL: (516) 334-5959 • (800) 899-8438 • FAX: (516) 334-5988



---

**IET LABS, INC.**

534 Main Street, Westbury, NY 11590

[www.ietlabs.com](http://www.ietlabs.com)

TEL: (516) 334-5959 • (800) 899-8438 • FAX: (516) 334-5988