

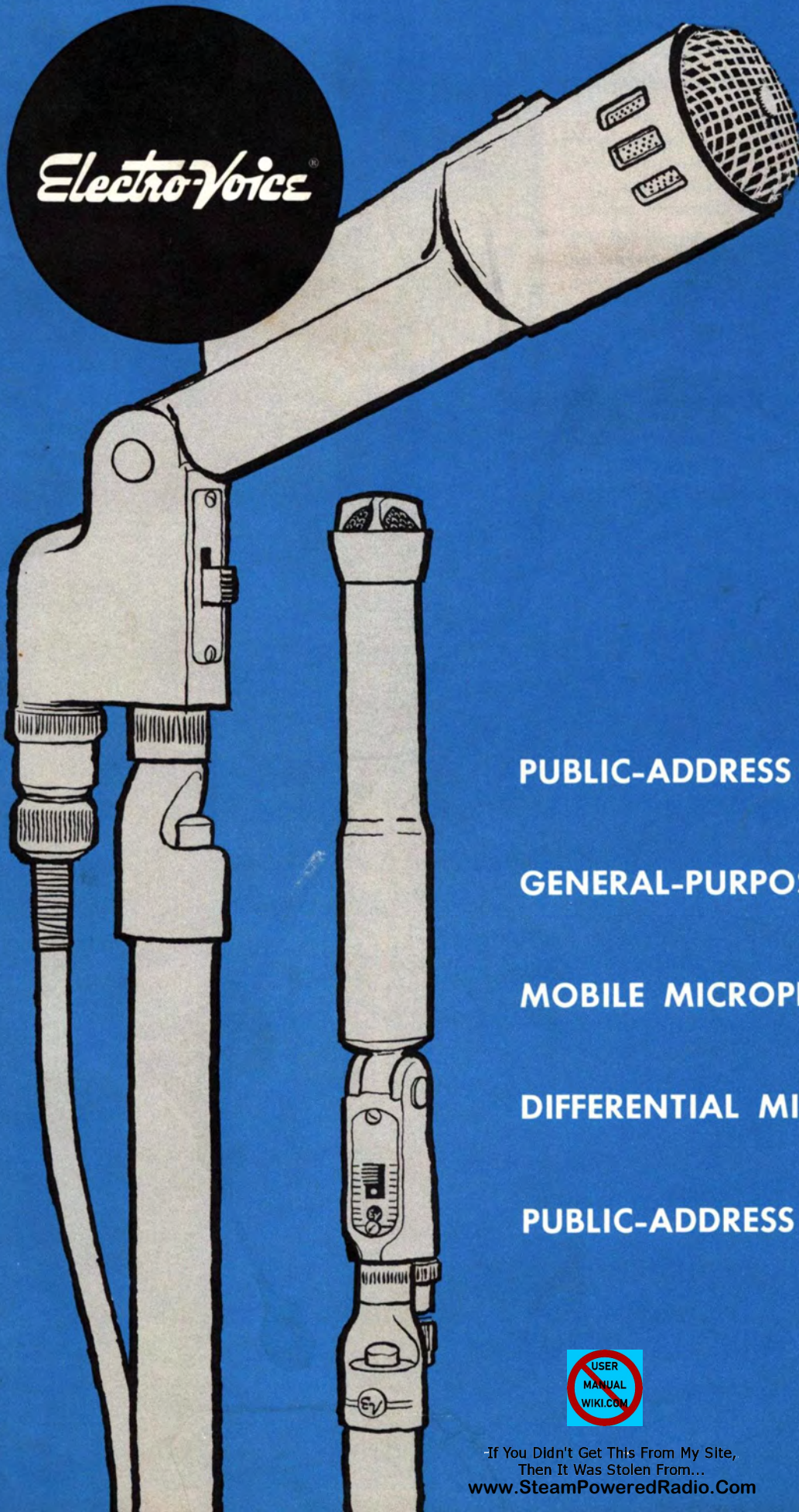

*Electro-Voice*<sup>®</sup>



**PUBLIC-ADDRESS MICROPHONES**

**GENERAL-PURPOSE MICROPHONES**

**MOBILE MICROPHONES**

**DIFFERENTIAL MICROPHONES**

**PUBLIC-ADDRESS SPEAKERS**



-If You Didn't Get This From My Site,  
Then It Was Stolen From...  
[www.SteamPoweredRadio.Com](http://www.SteamPoweredRadio.Com)



**T**HIS IS ELECTRO-VOICE, where skilled engineers and artisans use the best of equipment to produce a complete range of broadcast-quality microphones for public-address and general purpose use.





## Dynamic, Crystal or Ceramic Microphones

## How to Select Your

# Electro-Voice

## MICROPHONE

No *one* microphone—not even an Electro-Voice microphone—does everything equally well. Although each E-V microphone is remarkably versatile, different applications require different types of microphones. Electro-Voice P.A. and general-purpose microphones are available in two basic types . . . omnidirectional and cardioid (unidirectional).

Utilizing the exclusive Electro-Voice Acoustalloy non-metallic diaphragm, E-V dynamic microphones offer smooth response over a wider frequency range and withstand high humidity, temperature extremes, corrosive effects of salt air, and severe mechanical shocks. They are practically indestructible in normal use. Excellent for both voice and music, the rugged Electro-Voice dynamic microphones are ideal for all types of P.A., dispatching/call, recording, amateur radio and general communication applications.

For applications where low initial cost is important and where high humidity, extreme temperatures or severe mechanical shocks are *not* a factor, a crystal microphone is a highly satisfactory choice. Crystal microphones are widely used for amateur radio, home recording, dictating, P.A., call and paging systems. **IMPORTANT:** Crystal microphones should not be exposed to temperatures higher than 112° F. Avoid exposure to direct sunlight; do not leave in closed automobiles or show windows for extended periods during hot weather.

Ceramic microphones are unaffected by heat and humidity and are longer-lived than crystal microphones. However, their output level is slightly lower.

## Omnidirectional or Cardioid Microphones?

**E-V Omnidirectional** microphones pick up all sound regardless of the direction it comes from. Only for higher frequencies are they more sensitive at the front than at the back. For applications where background noise is low, acoustical conditions are reasonably good and the working distance to the microphone is not great, omnidirectional microphones are the logical choice.



**E-V Cardioid** (unidirectional) microphones pick up only the sound arriving at the front (practically "dead" at rear). They provide highly directional sound selectivity and halve the pickup of ambient noise and reverberation, thus minimizing feedback under undesirable acoustic conditions. There is no finer choice than an E-V cardioid microphone to stop unwanted sounds, give accurate, natural pickup of voice and music . . . smooth, peak-free response and no boominess from close talking. They actually double the working distance of the user, allowing greater freedom of action.



## Electro-Voice P. A. and General Purpose Microphone Classification Chart

	Cardioid	Omnidirectional	
Dynamic	Model 664	Model 647 Model 636 Model 648 Model 623	Model 630 Model 611 Model 605 Model 615
Crystal	Model 951	Model 911 Model 920 Model 926 Model 927	Model 924 Model 915 Model 912
Ceramic		Model 715	Model 727





# Electro-Voice

## High-Fidelity

### Cardioid Dynamic Microphone

Model 664 • List \$85.00 (less stand)

The Electro-Voice 664 is so revolutionary that it is guaranteed to outperform any other P.A. cardioid . . . or your money back. Utilizing the amazing E-V Variable D design, the high-fidelity 664 is the world's finest P.A. and general-purpose microphone. Unidirectional, it provides highly directional sound selectivity, reduces pickup due to ambient noise and reverberation up to 50% ; has highest sound level to feed-back ratio. Its greater pickup range doubles conventional working distance. Proper placement of the 664 stops unwanted sounds, gives accurate, natural pickup of voice and music . . . smooth, peak-free response from 40 to 15,000 cps, *no boominess* from close talking. These features make it especially useful in locations where ambient noise and severe reverberation exist.

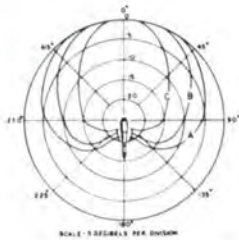

A — 300 cps      B — 5,000 cps  
C — 10,000 cps  
**Polar Pattern**

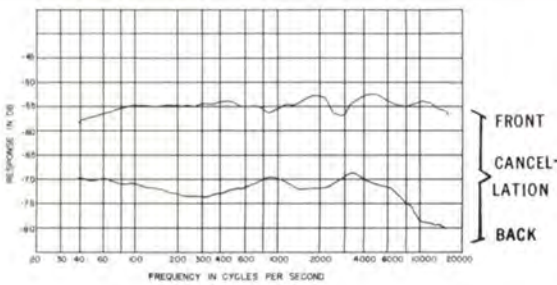

**Frequency Response**

## Exclusive E-V Variable D Design . . .

. . . is a completely new principle that provides three sound-cancelling entrances at different fixed distances in back of the diaphragm. These entrances, utilizing the proper acoustical impedance, combine to form effective front-to-back spacing which varies in distance from the diaphragm inversely with frequency. The resulting phase and amplitude conditions provide a uniform cardioid pattern at all frequencies. With just one moving element, Variable D makes the Model 664 a triumph of electro-acoustic design and trouble-free mechanical simplicity.



### Here's How it Works

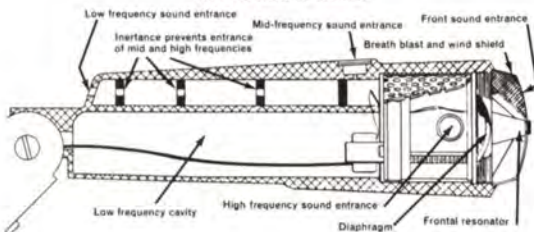

**Exclusive Acoustalloy Nonmetallic Diaphragm**—the only moving element in the microphone—withstands high humidity, temperature extremes, corrosive effects of salt air, and severe mechanical shocks. In normal use, it is practically indestructible.

**Pop-proof filter** minimizes wind and breath blasts.

# *Electro-Voice*

## High-Fidelity Cardioid Dynamic Microphone

### Model 664

#### SPECIFICATIONS

**Directional Characteristic:** Cardioid

**Type:** Dynamic

**Frequency Response:** 40 to 15,000 cps

**Impedances Available:** 150 ohms and Hi-Z. Selection made at cable plug.

**Output Level:** 150 ohms: -55 db\*; RETMA sensitivity rating, -149 db

Hi-Z: -55 db\*\*; RETMA sensitivity rating, -151 db

\*0 db = 1 mw/10 dynes/cm<sup>2</sup>

\*\*0 db = 1 volt/dyne/cm<sup>2</sup>

**On-Off Switch:** Sliding contact shorts microphone in OFF position. Can be rewired easily for relay control.

**Magnetic Circuit:** Alnico V and Armco magnetic iron in a non-welded circuit.

**Diaphragm:** Electro-Voice Acoustalloy.

**Case:** High-pressure-cast zinc.

**Finish:** Satin chromium

**Dimensions:** Diameter: 1 $\frac{7}{8}$  in. max.

Length: 7 $\frac{3}{16}$  in., not including stud

**Net Weight:** 1 lb., 10 oz., without cable

**Cable:** 18-ft., two-conductor, shielded, synthetic rubber jacketed, broadcast type.

**Cable Connector:** MC4M Amphenol

**Stand Coupler:**  $\frac{5}{8}$  in. -27 thread on stud.

**Additional Accessories and prices listed on Page 21.**





# Electro-Voice

## Cardioid Crystal Microphone

Model 951 • List \$49.50 (less stand)

The Electro-Voice Model 951 is a cardioid microphone of the crystal type which incorporates the Variable D design to obtain cardioid directivity. This cardioid pattern is obtained through the use of two sound entrances located in the microphone case at different distances in back of the diaphragm. These sound entrances, each utilizing the proper acoustical impedance, combine to form one effective back entrance which varies in distance from the diaphragm inversely with the frequency. The resulting phase and amplitude conditions produce a uniform cardioid pattern over a wide frequency range. The mechanical construction utilized is inherently rugged, affording high protection from mechanical shock damage.

The Model 951\* is an all-purpose public address microphone designed to fulfill requirements of wide-range reproduction under a great variety of conditions. Because of its excellent and uniform polar response, it is especially useful in locations where ambient noise and severe reverberation exist. It is equipped with a pop-proof wire mesh grille which minimizes wind and breath blasts. The Model 951 can be used on a floor or desk stand or carried in the hand.

The Cardioid characteristic of the Model 951 gives wide angle front pick-up, but is virtually dead from the rear, as indicated in the Polar Pattern. In addition the Model 951 gives the following advantages:

1. The uniform cardioid characteristic allows nearly double the pickup range (distance from performer on sound source to microphone), over that of the conventional omnidirectional microphone for average conditions of reverberation, acoustic feedback and room noise. For public address applications, this pick-up range may be increased considerably by proper placement of loudspeakers so that direct and reflected sound strikes the microphone at the back (dead zone).
2. Random room noise and reverberation are reduced by a factor of 67%.
3. The microphone may be positioned to cancel or substantially diminish pickup of unwanted sounds.
4. High crystal capacitance makes possible the use of moderately long microphone cables. The crystal is sealed against moisture to extend the crystal life.
5. High output level of the Model 951 enables it to be used with any standard amplifier employing high impedance input.

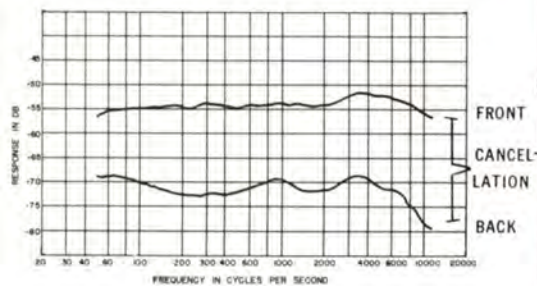

Frequency Response

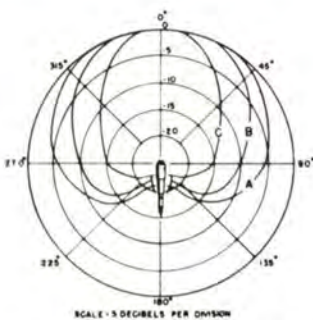

A — 300 cps      B — 5,000 cps  
C — 10,000 cps

Model 951 Polar Pattern



## Cardioid Crystal Microphone Model 951

### SPECIFICATIONS

**Directional Characteristics:** Cardioid

**Type:** Crystal

**Frequency Response:** 50 to 11,000 cps

**Impedance:** Hi-Z

**Output Level:** -55db (0 db = 1 volt/dyne/cm<sup>2</sup>) RETMA sensitivity rating, -155db

**On-Off Switch:** Sliding contact shorts microphone in OFF position

**Case:** High-pressure diecast zinc

**Finish:** Satin chromium

**Dimensions:** Diameter: 1 $\frac{3}{4}$  in. overall  
Length; 5 $\frac{3}{8}$  in., without stand-coupler

**Net Weight:** 1 $\frac{1}{4}$  lbs., without cable

**Cable:** 18 ft. single-conductor shielded. Additional cable reduces output level but does not distort frequency response (See Fig. 2).

**Cable Connector:** MC-1 Amphenol

**Stand Coupler:**  $\frac{5}{8}$  in. -27 thread

**Additional Accessories and prices listed on Page 21.**





# Electro-Voice

## Omnidirectional Dynamic Lavalier Microphone

Model 647 • List \$82.50

The Electro-Voice Model 647 combines smooth, wide-range response and high output with exceptional flexibility. This slim, miniaturized microphone can be hung on a neck cord close to the chest . . . leaving hands of user free for demonstrations . . . or it can be held in the hand, used on a desk stand, or suspended from a boom. Requiring no closely associated auxiliary equipment, the Model 647 is excellent for use wherever individual mobility, free movement of the hands, or microphone concealment is desired.

### VERSATILE . . .

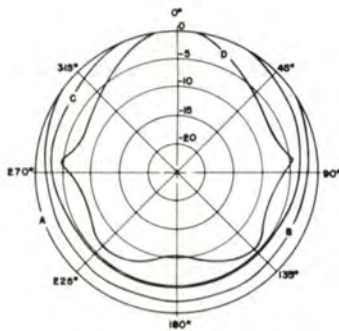

SCALE: 5 DECIBELS PER DIVISION

A — 500 cps      C — 5,000 cps  
B — 1,500 cps    D — 10,000 cps

Polar Pattern

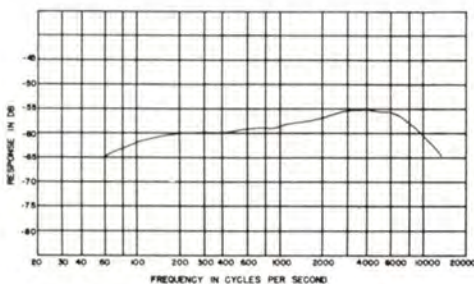

Frequency Response

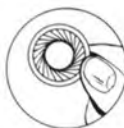

**Exclusive Acoustalloy Nonmetallic Diaphragm**—the only moving element in the microphone—withstands high humidity, temperature extremes, corrosive effects of salt air, and severe mechanical shocks. In normal use, it is practically indestructible.

**Pop-proof filter** minimizes wind and breath blasts.

The Electro-Voice Model 647 includes as standard equipment: combination easy-to-fasten neck cord and tie clip for microphone, belt clip for cable and 18' cable.



# Electro-Voice

## Omnidirectional Dynamic Lavalier Microphone

### Model 647

#### SPECIFICATIONS

**Directional Characteristic:** Omnidirectional, becoming slightly directional at high frequencies.

**Type:** Dynamic

**Frequency Response:** Smooth, peak-free, 60 to 10,000 cps, with slightly rising characteristic specifically calculated to assure crisp, clear pickup when Model 647 is used on the chest as a lavalier, in the hand or on a desk.

**Impedances Available:** 150 ohms or Hi-Z. (Specify when ordering.)

**Output Level:** 150 ohms: -57 db\*; RETMA Sensitivity Rating, -151 db  
Hi-Z: -57 db\*\*; RETMA Sensitivity Rating, -153 db  
\*0 db equals 1 mw/10/dynes/cm<sup>2</sup>  
\*\*0 db equals 1 volt/dyne/cm<sup>2</sup>

**Magnetic Circuit:** Alnico V and Armco magnetic iron in a non-welded, precision-ground, magnetic structure.

**Diaphragm:** Electro-Voice Acoustalloy

**Case:** Lathe turned, high-tensile-strength aluminum.

**Finish:** TV-gray with satin chromium trim and clip.

**Dimensions:** Diameter: 1 1/8 in.

Length: 5 in.

**Net Weight:** 6 oz., less cable

**Cable:** Standard broadcast, two-conductor, shielded, synthetic-jacketed, 18 ft. long.

**Cable Connector:** Lug type, detachable

**Standard Accessories supplied with microphone:**

Neck cord assembly, Belt strain relief clip, Hex key wrench, Spanner wrench.

**Additional Accessories and prices listed on Page 21.**





# Electro-Voice

## Omnidirectional Dynamic Microphone

### Model 636

... with the New Slim-Trim Look

Satin Chromium Finish, List \$72.50 (less stand)

Gold Finish, List \$77.50 (less stand)

The Electro-Voice Model 636 is a startling study in new design, new efficiency and new flexibility. It brings the advantages of slim-trim styling to the P.A. and general-purpose field. Measuring only 1½ inches in diameter, Model 636 eliminates upper-frequency "pressure doubling" effects—resulting in completely clean high frequencies. Yet, its output level is equal to that of microphones four times as large.

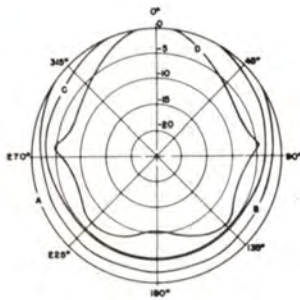

SCALE: 5 DECIBELS PER DIVISION

A — 500 cps      C — 5,000 cps  
 B — 1,500 cps      D — 10,000 cps

Polar Pattern

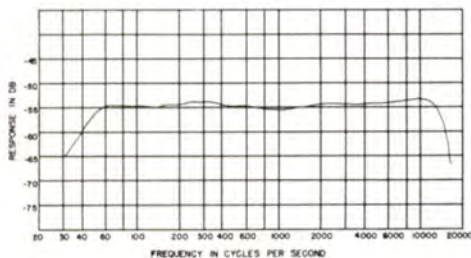

Frequency Response



**Exclusive Acoustalloy Nonmetallic Diaphragm**—the only moving element in the microphone—withstands high humidity, temperature extremes, corrosive effects of salt air, and severe mechanical shocks. In normal use, it is practically indestructible.

**Pop-proof filter** minimizes wind and breath blasts.





## Omnidirectional Dynamic Microphone

### Model 636

#### SPECIFICATIONS

**Directional Characteristic:** Omnidirectional, becoming slightly directional at high frequencies.

**Type:** Dynamic

**Frequency Response:** 60 to 15,000 cps, substantially flat.

**Impedances Available:** 150 ohms and Hi-Z. Selection made at plug.

**Output Level:** 150 ohms: -55 db\*; RETMA Sensitivity Rating, -149 db

Hi-Z: -55 db\*\*; RETMA Sensitivity Rating, -151 db

\*0 db equals 1 mw/10 dynes/cm<sup>2</sup>

\*\*0 db equals 1 volt/dyne/cm<sup>2</sup>

**On-Off Switch:** Sliding contact shorts microphone in OFF position. Can be rewired easily for relay control.

**Magnetic Circuit:** Alnico V and Armco magnetic iron in a non-welded circuit.

**Diaphragm:** Electro-Voice Acoustalloy

**Case:** Steel

**Finish:** Satin chromium. Also available in lacquer-protected Gold Finish.

**Dimensions:** Diameter: 1½ in.

Length: 10¼ in.

**Net Weight:** 15 oz.

**Cable:** 18-ft., two-conductor, shielded, synthetic rubber jacketed, broadcast type.

**Cable Connector:** MC4M Amphenol

**Stand Coupler:** ⅝ in. -27 thread

**Additional Accessories and prices listed on Page 21.**



# Electro-Voice

## Omnidirectional Dynamic Microphone Featuring the Slim-Trim Look

Model 648 • List \$56.00 (less stand)

The Electro-Voice Model 648, originally created for the audio console in TV and broadcast intercom, brings the advantages of the slim, trim look to the P.A. and general purpose field. Furnished with a built-in connector and mating adapter, it may be mounted on a rigid or flexible boom, desk or floor stand. All leads can be concealed. The microphone is equipped with a pop-proof filter and the amazing, exclusive E-V Acoustalloy diaphragm that is practically indestructible in normal use.

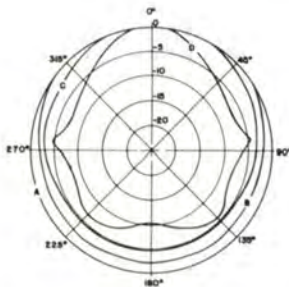

SCALE: 0 DECIBELS PER DIVISION

A — 500 cps      C — 5,000 cps  
B — 1,500 cps    D — 10,000 cps

Polar Pattern

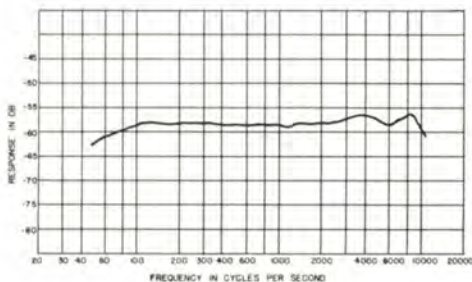

Frequency Response

### SPECIFICATIONS

**Directional Characteristic:** Omnidirectional, becoming slightly directional at high frequencies.

**Type:** Dynamic

**Frequency Response:** Uniform from 50 to 10,000 cps

**Impedances Available:** 50, 150, or 250 ohms. (Specify when ordering.) Line balanced to ground and phased.

**Output Level:** 50 ohms: -58 db\*; RETMA Sensitivity Rating, -151 db

150 ohms: -58 db\*; RETMA Sensitivity Rating, -152 db

250 ohms: -58 db\*; RETMA Sensitivity Rating, -150 db

\*0 db = 1 mw/10 dynes/cm<sup>2</sup>

**Magnetic Circuit:** Alnico V and Armco magnetic iron in a non-welded circuit.

**Diaphragm:** Electro-Voice Acoustalloy

**Case:** High-tensile, lathe-turned aluminum

**Finish:** Nonreflecting TV gray

**Dimensions:** Microphone only  
Diameter: 1 1/8 in.  
Length: 5 9/16 in.

**Net Weight:** 6 oz. less cable

**Cable:** None supplied

**Standard Accessories supplied with microphone:**  
Model 348 Adapter; Two Allen wrenches.

**Additional Accessories and prices listed on Page 21.**



# Electro-Voice

## Omnidirectional Dynamic Microphone

Model 623 • List \$57.00 (less stand)

The Electro-Voice Model 623 with its modern slim-contour styling is inconspicuous and easy to handle. Excellent for both music and speech, it is mounted on a swivel which permits tilting through a 57° arc toward the sound source for improved pickup. The Model 623 can be mounted on a floor or desk stand, or held in the hand, has convenient on-off switch. It features the famous, exclusive E-V Acoustalloy diaphragm that is practically indestructible.

### SPECIFICATIONS

**Directional Characteristic:** Omnidirectional, becoming slightly directional at high frequencies.

**Type:** Dynamic

**Frequency Response:** 60 to 12,000 cps

**Impedances Available:** 150 ohms and Hi-Z. Selection made at plug. Low impedance balanced to ground and phased.

**Output Level:** 150 ohms: -56 db\*; RETMA Sensitivity Rating, -151 db

Hi-Z: -56 db\*; RETMA Sensitivity Rating, -152 db

\*0 db = 1 mw/10 dynes/cm<sup>2</sup>

**On-Off Switch:** Sliding contact shorts microphone in OFF position. Can be rewired easily for relay control.

**Magnetic Circuit:** Alnico V and Armco magnetic iron in a non-welded circuit.

**Diaphragm:** Electro-Voice Acoustalloy

**Case:** High-pressure diecast zinc

**Finish:** Satin chromium

**Dimensions:** Diameter: 1 5/16 in.  
Length: 9 1/4 in. including stud

**Net Weight:** 15 oz. without cable

**Cable:** 18-ft., two-conductor, shielded, synthetic rubber jacketed.

**Cable Connector:** Amphenol MC-4

**Stand Coupler:** 5/8 in. -27 thread

**Additional Accessories and prices listed on Page 21.**

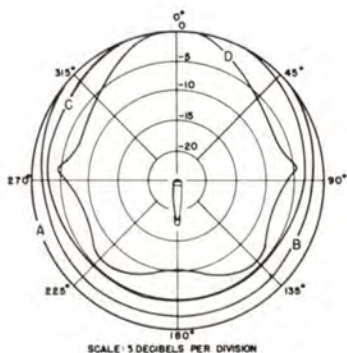

A — 500 cps      C — 4,000 cps  
B — 1,200 cps    D — 8,000 cps

Polar Pattern

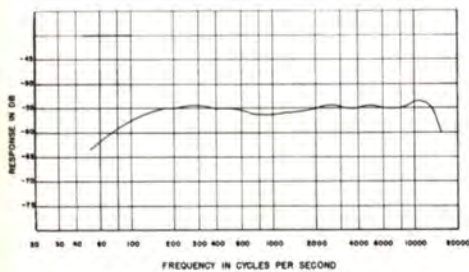

Frequency Response





# Electro-Voice

## Omnidirectional Dynamic Microphone

**Model 630 • List \$52.50 (less stand)**

The Electro-Voice Model 630, excellent for both voice and music, was specifically designed for P.A. work and all types of dispatching call systems, industrial applications, remote pickups, recording, visual aids, amateur radio and general communication service. During the last decade, the 630 has earned a world-wide reputation for fine reproduction and un-failing service. The Model 630 may be mounted on a floor or desk stand and tilted through a 90° arc toward the sound source. It also may be held in the hand. The rugged, exclusive E-V Acoustalloy diaphragm makes this microphone practically indestructible in normal use.

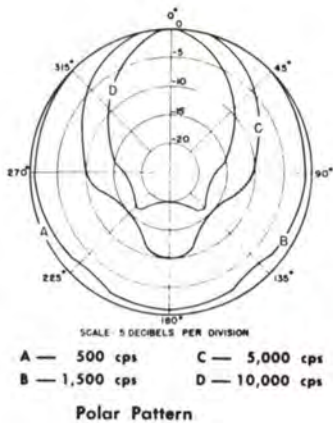

### SPECIFICATIONS

**Directional Characteristic:** Omnidirectional, becoming directional with rise in frequency.

**Type:** Dynamic

**Frequency Response:** 60 to 11,000 cps.

**Impedances Available:** 50 ohms, 250 ohms or Hi-Z. (Specify when ordering.) Low-impedance models have balanced line output.

**Output Level:** 50 ohms: -55 db\*; RETMA Sensitivity Rating, -148 db

250 ohms: -55 db\*; RETMA Sensitivity Rating, -147 db

Hi-Z: -55 db\*\*; RETMA Sensitivity Rating, -151 db

\*0 db = 1 mw/10 dynes/cm<sup>2</sup>

\*\*0 db = 1 volt/dyne/cm<sup>2</sup>

**On-Off Switch:** Sliding contact shorts microphone in OFF position.

**Magnetic Circuit:** Alnico V and Armco magnetic iron in a non-welded circuit.

**Diaphragm:** Electro-Voice Acoustalloy

**Case:** High-pressure diecast zinc

**Finish:** Satin chromium

**Dimensions:** Diameter: 2 in.  
Length: 6¼ in.

**Net Weight:** 1 lb. less cable

**Cable: Low Impedances:** 18-ft., two-conductor, synthetic rubber jacketed.

Hi-Z: 18-ft., single-conductor, synthetic rubber jacketed.

**Cable Connector:** MC-3 locking, three-contact wiping type built into the microphone.

**Stand Coupler:** ⅝ in.—27 thread

**Additional Accessories and prices listed on Page 21.**

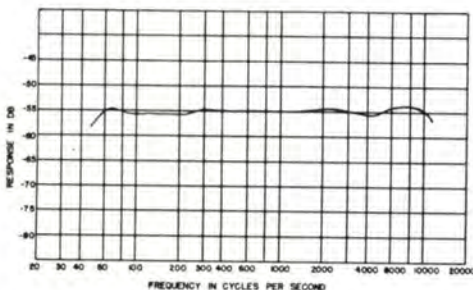

**Frequency Response**

If You Didn't Get This From My Site,  
Then It Was Stolen From...

[www.SteamPoweredRadio.Com](http://www.SteamPoweredRadio.Com)



# Electro-Voice

## Omnidirectional Dynamic Microphone

Model 611 • List \$45.00 (less stand)

Traditionally styled, the Electro-Voice Model 611 combines compact, sturdy construction with high level output, selective pickup, and pleasing appearance. It offers unusual value for a wide variety of P.A. and general-purpose work . . . dispatching, call and paging systems; amateur radio; and general communication service. The exclusive E-V Acoustalloy diaphragm virtually eliminates maintenance costs.

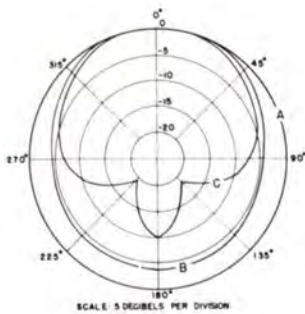

A — 500 cps      B — 1,400 cps  
C — 3500 cps

Polar Pattern

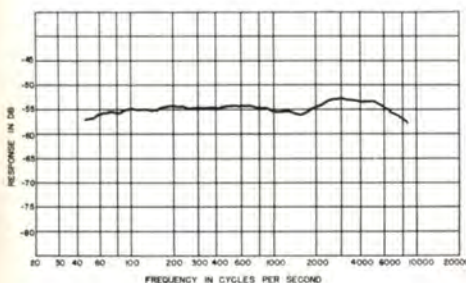

Frequency Response

### SPECIFICATIONS

**Directional Characteristic:** Omnidirectional, becoming directional at high frequencies.

**Type:** Dynamic

**Frequency Response:** 50 to 9000 cps

**Impedances Available:** 50, 150, 250 ohms or Hi-Z. (Specify when ordering.)

**Output Level:** Low Impedances: -55 db\*; RETMA Sensitivity Rating, -148 db for 50 ohms, -149 db for 150 ohms, -147 db for 250 ohms.

Hi-Z: -55 db\*\*; RETMA Sensitivity Rating, -151 db

\*0 db = 1 mw/10 dynes/cm<sup>2</sup>

\*\*0 db = 1 volt/dyne/cm<sup>2</sup>

**On-Off Switch:** Sliding contact shorts microphone in OFF position. Can be rewired easily for relay control.

**Magnetic Circuit:** Alnico V and Armco magnetic iron in a non-welded circuit.

**Case:** High-pressure diecast zinc

**Finish:** Satin chromium

**Dimensions:** Height: 6¾ in. including stud

Width: 2¾ in.

Depth: 3½ in.

**Net Weight:** 1¼ lb.

**Cable:** 18-ft., two-conductor, shielded for low impedances.

18-ft., single-conductor, shielded for Hi-Z.

**Cable Connector:** MC3M for low impedances. MC-1 Amphenol for Hi-Z.

**Stand Coupler:** ⅝ in. -27 thread

**Additional Accessories and prices listed on Page 21.**





# Electro-Voice

## Omnidirectional Dynamic Microphone

**Model 605 • List \$32.50 (less stand)**

The Electro-Voice Model 605 was designed to bring all the advantages of dynamic microphones to the P.A. field at a budget price. It combines excellent speech pickup characteristics with high-level output and pleasing appearance. Its durable construction and exclusive E-V Acoustalloy diaphragm permit indoor and outdoor use without fear of damage from hard usage, extreme temperature or humidity . . . practically no maintenance cost.

### SPECIFICATIONS

**Directional Characteristic:** Omnidirectional, becoming directional at high frequencies.

**Type:** Dynamic

**Frequency Response:** 65 to 8000 cps

**Impedances Available:** 50 ohms, 250 ohms or Hi-Z. (Specify when ordering.)

**Output Level:** Low Impedances: -55 db\*; RETMA Sensitivity Rating, -148 db for 50 ohms, -147 for 250 ohms. Hi-Z: -55 db\*\*; RETMA Sensitivity Rating, -151 db

\*0 db = 1 mw/10 dynes/cm<sup>2</sup>

\*\*0 db = 1 volt/dyne/cm<sup>2</sup>

**Case:** High-pressure diecast zinc

**Dimensions:** Diameter: 2 in.; Length, 3¼ in., including stud.

**Finish:** Satin chromium

**Net Weight:** 12 oz. less cable

**Cable:** 18-ft., single-conductor, shielded.

**Cable Connector:** MC-1 Amphenol

**Stand Coupler:** 5/8 in. -27 thread

**Additional Accessories and prices listed on Page 21.**

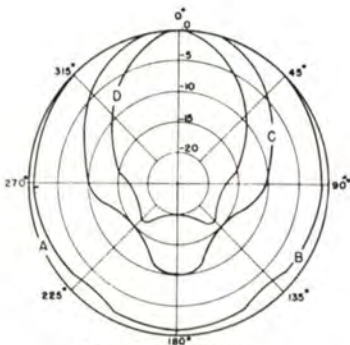

SCALE: 5 DECIBELS PER DIVISION

A — 500 cps      C — 5,000 cps  
B — 1,500 cps    D — 10,000 cps

Polar Pattern

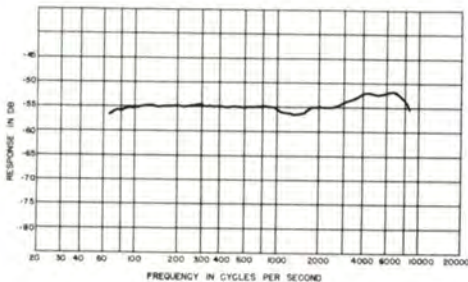

Frequency Response

# Electro-Voice

## Omnidirectional Crystal Microphone

Model 911 • List \$32.50 (less stand)

Traditionally styled, the Electro-Voice Model 911 is an economical all-around unit for amateur radio, general communication, and P.A. and paging systems in auditoriums, churches, hotels, theaters, offices and schools. Its high output level makes it possible to operate the amplifier at a lower gain setting. Compact and sturdy, the Model 911 withstands a maximum of hard usage.

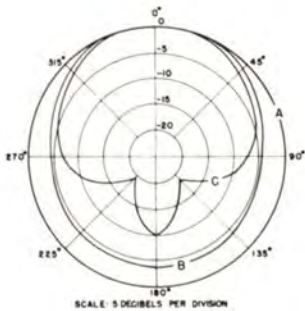

A — 500 cps      B — 1,400 cps  
C — 3500 cps

Polar Pattern

### SPECIFICATIONS

**Directional Characteristic:** Omnidirectional, becoming directional at high frequencies.

**Type:** Crystal

**Frequency Response:** 50 to 9000 cps

**Impedance:** Hi-Z

**Output Level:** -50 db\*\*; RETMA Sensitivity Rating, -150 db  
\*\*0 db = 1 volt/dyne/cm<sup>2</sup>

**On-Off Switch:** Sliding contact shorts microphone in OFF position.

Can be rewired easily for relay control.

**Case:** High-pressure diecast zinc

**Finish:** Satin chromium

**Dimensions:** Height 6 $\frac{3}{4}$  in. including stud  
Width 2 $\frac{3}{8}$  in.  
Depth 3 $\frac{1}{8}$  in.

**Net Weight:** 1 lb. less cable

**Cable:** 18-ft., single-conductor, shielded.

**Cable Connector:** MC-1 Amphenol

**Stand Coupler:**  $\frac{5}{8}$  in. -27 thread

**Additional Accessories and prices listed on Page 21.**

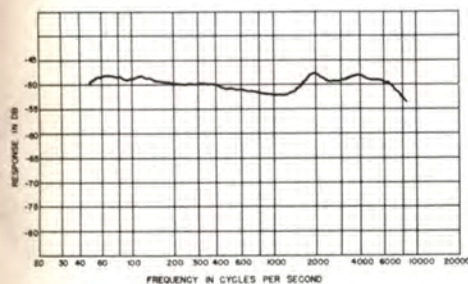

Frequency Response



# Electro-Voice

## Omnidirectional Crystal Microphone

Model 926 • List \$29.50 (less stand)

The Electro-Voice Model 926 with its slim-contour styling is inconspicuous and easy to handle. Modestly priced, it is an excellent choice for all types of P.A., call and paging systems, home tape recorders, amateur radio, and general communication. Swivel mounting permits tilting the Model 926 microphone through a 105° arc toward the sound source. The Model 926 can be mounted on floor or desk stand, on a boom, or carried in the hand.

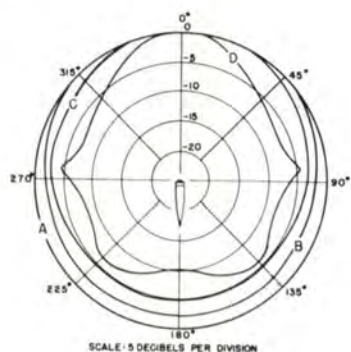

A — 500 cps      C — 4,000 cps  
B — 1,200 cps    D — 8,000 cps

Polar Pattern

### SPECIFICATIONS

**Directional Characteristic:** Essentially omnidirectional, becoming slightly directional at high frequencies.

**Type:** Crystal

**Frequency Response:** 60 to 8000 cps

**Impedance:** Hi-Z

**Output Level:** -60 db\*\*; RETMA Sensitivity Rating, -160 db  
\*\*0 db = 1 volt/dyne/cm<sup>2</sup>

**Case:** High-pressure diecast

**Finish:** Satin chromium

**Dimensions:** Diameter: 1<sup>5</sup>/<sub>16</sub> in.  
Length: 6<sup>3</sup>/<sub>4</sub> in.

**Net Weight:** 11 oz. without cable

**Cable:** 18-ft., single-conductor, shielded, rubber jacketed.  
Equipped with strain relief spring to prevent cable breakage.

**Stand Coupler:** 5/8 in. -27 thread

**Additional Accessories and prices listed on Page 21.**

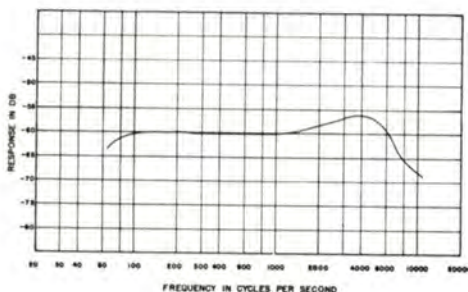

Frequency Response



# Electro-Voice

## Spherex Omnidirectional Crystal Microphone

Model 920 • List \$27.50 (less stand)

The Electro-Voice Spherex Model 920 is extremely useful for wide-angle pickup. Uniquely, its diaphragm is mounted in a horizontal plane resulting in a high receptivity to sound pressures from any direction. This feature makes Model 920 ideal for applications where accurate group or conference pickup is desired.

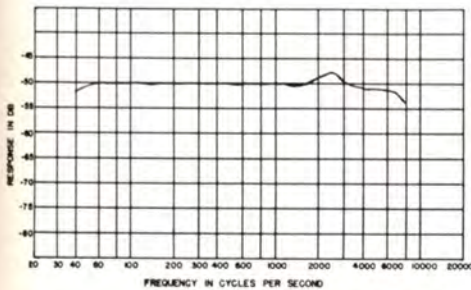

Frequency Response

### SPECIFICATIONS

**Directional Characteristic:** Omnidirectional, becoming slightly directional at high frequencies.

**Type:** Crystal

**Frequency Response:** 60 to 7000 cps

**Impedance:** Hi-Z

**Output Level:** -50 db\*\*; RETMA Sensitivity Rating, -150 db  
\*\*0 db = 1 volt/dyne/cm<sup>2</sup>

**Case:** High-pressure diecast zinc

**Finish:** Satin chromium

**Dimensions:** Diameter: 2<sup>5</sup>/<sub>16</sub> in.

Height: 2<sup>13</sup>/<sub>16</sub> in.

**Net Weight:** 8 oz.

**Cable:** 18-ft., single-conductor, shielded.

**Stand Coupler:** 5/8 in. -27 thread

**Additional Accessories and prices listed on Page 21.**







# Electro-Voice

## Omnidirectional Crystal Microphone

Model 927\* • List \$22.50 (including stand)

The Electro-Voice Model 927 is slim, trim and terrific! It's a star performer at a popular price for P.A., call and paging systems, home tape recorders, dictating machines, and general communication. Easy to hold in the hand, the Model 927 mounts firmly in its own slip-in stand for desk use.

**\*Also Available:** Model 927S, same as Model 927 but with On-Off switch, List \$24.50. Model 727, the styling of the Model 927 but with long-lived ceramic element, slightly lower level, List \$22.50. Model 727S, same as Model 727 but with On-Off switch, List \$24.50.

### SPECIFICATIONS

**Directional Characteristic:** Omnidirectional, becoming directional at high frequencies.

**Type:** Model 927: Crystal  
Model 727: Ceramic

**Frequency Response:** Model 927: 60 to 8000 cps  
Model 727: 60 to 8000 cps

**Impedance:** Hi-Z.

**Output Level:** Model 927: -50 db\*\*; RETMA Sensitivity Rating, -150 db

Model 727: -59 db\*\*; RETMA Sensitivity Rating, -159 db

\*\*0 db = 1 volt/dyne/cm<sup>2</sup>

**Case:** High-pressure diecast front and heavy-wall plastic back.

**Finish:** Metalustre-gray front and medium-gray back.

**Dimensions:** Width: 1<sup>7</sup>/<sub>16</sub> in.  
Depth: 1<sup>11</sup>/<sub>32</sub> in.  
Length: 7<sup>1</sup>/<sub>16</sub> in.

**Net Weight:** 14 oz. including cable

**Cable:** 5 ft., single-conductor, shielded, plastic jacketed.

Equipped with internal strain relief to prevent cable breakage.

**Standard Accessories supplied with microphone:**  
Model 417 Desk Stand.

**Additional Accessories and prices listed on Page 21.**

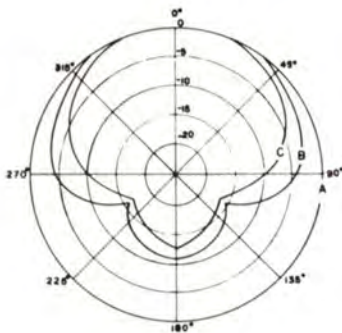

SCALE - 5 DECIBELS PER DIVISION

A — 1,000 cps      B — 2,000 cps  
C — 5,000 cps

Polar Pattern

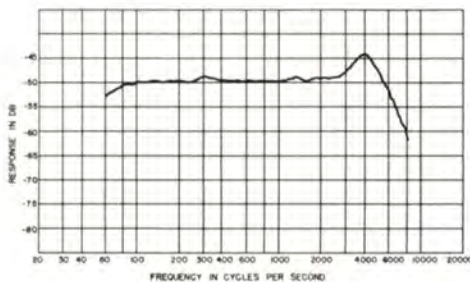

Frequency Response

If You Didn't Get This From My Site,  
Then It Was Stolen From...

www.SteamPoweredRadio.Com

# Electro-Voice

## Omnidirectional Crystal Microphone

Model 924 • List \$20.00

The Electro-Voice Model 924 features amazing performance for a microphone priced so reasonably. Smooth response from 60 to 8000 cps makes it especially useful for home recording, public address, and amateur radio. The Model 924 is easily held in the hand or used as a lavalier microphone, because of its small size.

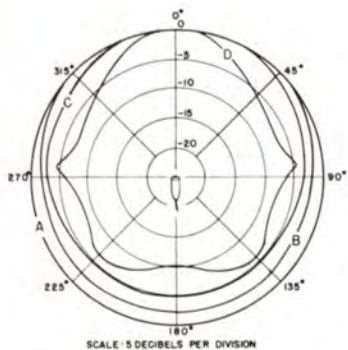

A — 500 cps      C — 5,000 cps  
B — 1,500 cps    D — 10,000 cps

Polar Pattern

### SPECIFICATIONS

**Directional Characteristic:** Omnidirectional, becoming slightly directional at high frequencies.

**Type:** Crystal

**Frequency Response:** 60 to 8000 cps

**Impedance:** Hi-Z

**Output Level:** -60 db\*\*; RETMA Sensitivity Rating, -160 db  
\*\*0 db = 1 volt/dyne/cm<sup>2</sup>

**Case:** Pressure diecast

**Finish:** Satin chromium

**Dimensions:** Diameter: 1<sup>7</sup>/<sub>32</sub> in.  
Length: 3<sup>5</sup>/<sub>32</sub> in.

**Net Weight:** 10 oz. including cable

**Cable:** 18 ft., single-conductor, shielded, rubber jacketed.

**Standard Accessories supplied with microphone:**

Neck Cord with easy-to-fasten clip.

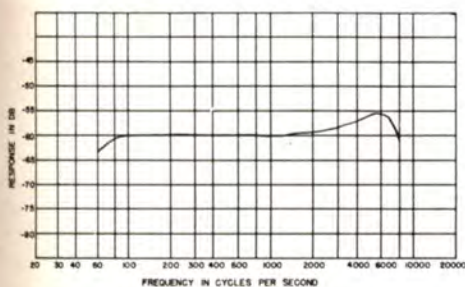

Frequency Response





# Electro-Voice

## Omnidirectional Crystal Microphone

**Model 915\* • List \$13.00 (less stand)**

The Electro-Voice Model 915 (illustrated on Model 415 stand) is a low-cost, multipurpose microphone. It is particularly useful for inexpensive P.A., home tape recording and paging systems. The Model 915 can be used in any position, in hand, on table, on stand, or overhead.

**\*Also Available:** Model 915S, same as Model 915 but with On-Off switch, List \$15.00. Model 715, same as Model 915 but with long-lived Ceramic element, slightly lower level, List \$13.00. Model 615, same as Model 915 except with dynamic element, somewhat higher level, List \$25.50.

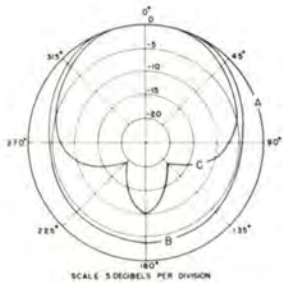

A—500 c.p.s.      B—1500 c.p.s.  
C—4000 c.p.s.

**Polar Pattern**

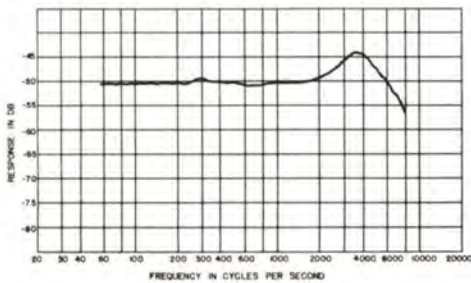

**Frequency Response**

### SPECIFICATIONS

**Directional Characteristics:** Omnidirectional, becoming directional at higher frequencies.

**Type:** Model 915: Crystal  
Model 715: Ceramic  
Model 615: Dynamic

**Frequency Response:**  
Model 915: 60 to 7000 cps  
Model 715: 60 to 7000 cps  
Model 615: 80 to 8000 cps

**Impedances Available:**  
Model 915 and 715: Hi-Z  
Model 615: 50 ohms or Hi-Z.  
(Specify when ordering.)

**Output Level:**  
Model 915: -50 db\*\*; RETMA Sensitivity Rating, -150 db  
Model 715: -59\*\*; RETMA Sensitivity Rating, -159 db  
Model 615: 50 ohms: -55 db\*; RETMA Sensitivity Rating, -148 db

Hi-Z: 55 db\*\*; RETMA Sensitivity Rating, -151 db  
\*0 db = 1 mw/10 dynes/cm<sup>2</sup>  
\*\*0 db = 1 volt/dyne/cm<sup>2</sup>

**On-Off Switch:**  
(Model 915S only): Sliding contact shorts microphone in OFF position. Can be rewired easily for relay control.

**Case:** High-pressure diecast zinc.

**Finish:** Satin chromium

**Dimensions:** Height: 3 in.  
Width: 2<sup>3</sup>/<sub>16</sub> in.  
Depth: 1 in.

**Net Weight:** 10 oz.

**Cable:** 5-ft., single-conductor, shielded.

**Stand Coupler:**  
5/8 in. -27 thread adapter furnished with the microphone.

**Optional Accessories:**  
Model 415 Desk Stand; Model 423-A Desk Stand.

## Model 912 • List \$10.00

The Electro-Voice Model 912 is a low-cost crystal microphone that is especially useful for home recording and small P.A. systems. Lightweight and small in size, it fits the hand snugly; also may be used on a table without a stand.

### SPECIFICATIONS

**Directional Characteristic:**  
Omnidirectional, becoming directional at high frequencies.

**Type:** Crystal

**Frequency Response:** 70 to 7000 cps

**Impedance:** Hi-Z

**Output Level:**  
-50 db\*\*; RETMA Sensitivity Rating,

150 db  
\*\*0 db = 1 volt/dyne/cm<sup>2</sup>

**Case:** Gray styrene plastic

**Dimensions:** Height: 3 in.

Width: 2<sup>1</sup>/<sub>4</sub> in.

Depth: 1<sup>1</sup>/<sub>2</sub> in.

**Net Weight:** 4 oz. with cable

**Cable:** 5-ft., single-conductor





# Electro-Voice Microphone Accessories

## Model 418\* and 419\* Microphone Stands

These desk stands are styled to give a modern, pleasing appearance while supplying an appropriate base to hold the microphone to prevent tilting and toppling over.

Material, cast iron. Finish, gray. Dimensions: height, 2-1/16 in.; width, 4-7/16 in.; length, 5 1/2 in. Weight, 2 lb. 2 oz.

### Model 418 ... List \$10.00

The Model 418 is to be used with microphones having small-type studs such as E-V Models 611, 623, 630, 636 and 911.

### Model 419 ... List \$10.00

The Model 419 is to be used with microphones having large-type studs such as E-V Models 654, 664 and 665.

\*Also Available Model 418-S, same as Model 418 but with On-Off switch, List \$15.00. Model 419-S, same as Model 419 but with On-Off switch, List \$15.00

### Model 423-A Desk Stand ... List \$5.00

The Model 423-A desk stand has a sturdy, smartly styled, round diecast base which rests firmly on rubber base buttons. Stand threads, 3/8 in. -27 thread. Material: Base, diecast zinc; Risers, steel tubing. Finish, satin chromium. Dimensions: height, 1 in.; diameter, 5 3/8 in. Stem Riser: choice of 3 in. or 5 in. Weight, 1 lb.

### Model 428 Touch-To-Talk Stand ... List \$17.50

The Electro-Voice microphone stand, Model 428 is designed for any standard microphone mount which has 3/8 in. -27 threads. Switch is a blade type, single-pole double-throw. By removing the aluminum shield, the switch terminals are readily accessible for soldering. Finished in satin chromium; gray plastic switch lever with locking button. Material, diecast zinc and plastic. Dimensions: height, 7 in.; base diameter, 5 1/2 in. Weight, 1 3/4 lb.

### Model 425 DeLuxe Floor Stand ... List \$30.00

The Model 425 DeLuxe Floor Stand has a modern diecast base. A button at the top gives one-hand height control from 37 to 66 inches. Locks automatically on release. The shaft can be rotated without adjusting devices. Locking-type adjustable legs permit the stand to be placed flush against the wall. Stand threads, 3/8 in. -27 thread. Material, Base, diecast zinc. Riser, steel tubing. Finish, satin chromium. Dimensions: Base, three-leg spread 17 in., Rise, from 37 in. to 66 in. Weight, 7 1/2 lb.

### Model 448 Swivel Boom Mount ... List \$24.00

The Model 448 Microphone Desk Boom Mount is designed primarily for the Model 648 microphone, but may be used with any microphone having 3/8 in. -27 thread. (Microphones with 1-inch diameter may be mounted using Model 300 Clamp.) This unit is used in applications where desk mounting is desired, and will hold the microphone 11 3/8 inches off the mounting surface. The shaft extends 4 inches below the mounting surface and has an integral swivel allowing the microphone to be swung out of the way when desired. The base is permanently secured by screws in the swivel flange with the MC-2M cable connector extending through the

mounting surface allowing cable to be attached with ease. Material, steel. Finish, satin chromium. Cable connector, Amphenol MC-2M. Dimensions: diameter, 3/8 in.; length, 20-9/16 in. with 62° bend 4-9/16 in. from base. Weight, 1 lb. 5 oz.

### 345 Shock Mount ... List \$15.00

This dual-type, external shock mount prevents reproduction of external shocks and stand vibrations. The Model 345 has a 3/8 in. -27 pipe thread adapter and can be easily attached or removed. Note: Microphone must be centrally balanced or the shock mount will not function properly. Material, steel and diecast zinc. Finish, satin chromium. Dimensions: diameter, 1 1/2 in.; length, 4 3/8 in. Weight, 10 oz. Accessories, 2-13/16 in. extension adapter.

### Model 300 Detachable Microphone Clamp ... List \$10.00

This lightweight adapter fits any cylindrical microphone with a 1-inch case diameter and provides positive means to mount the microphone on a stand. Easily installed without tools with a finger-operated clamp. Rubber insert prevents slippage on microphone. 1/2-inch pipe thread adapter for 3/8 in. -27 thread supplied. Material, steel and aluminum. Finish: TV gray and chromium. Dimensions: diameter, 1 1/8 in.; length, 4-3/16. Weight: 4 oz.

### Model 335 Blast Filter ... List \$5.50

This blast filter has an acoustically treated, scientifically curved grille which minimizes wind and breath blasts yet does not affect frequency response. Specifically designed for the E-V Models 635, 630 and 605 microphones. Material, copper and zinc. Finish, satin chromium. Dimensions: diameter, 2-5/16 in.; depth, 1 3/4 in. Weight: 2 oz.

### Model 502 Matching Transformer ... List \$17.50

The Model 502 is designed for mounting on an amplifier chassis or in series with a microphone line. The transformer windings have low distributed capacity and are amply shielded against inductive hum by a shield inside the pressure-cast case. Designed for 50, 250, and 500 ohms — to Hi-Z amplifier input. Output impedance, approximately 40,000 ohms to Hi-Z. Broadcast fidelity with response of 40-20,000 cps ± 1db. The transformer has an MC-4M input connector. Case material, zinc. Finish, black. Mounting centers, 2 in. Cable: single-conductor, shielded, 2 1/2 ft. long. Shielding: magnetic and electrostatic. Dimensions: diameter, 2-11/32 in.; length, 4-17/32 in. Weight, 1 lb.

### Model 415 Desk Stand ... List \$1.75

Sleek, attractive desk stand designed for use with E-V Models 615, 715, 915 and 915S crystal microphones. Material, diecast zinc. Finish, satin chromium. Dimensions: Length, 2 3/8 in.; width, 2 3/8 in.; height, 1 in. Weight, 4 oz.

### Model 416 Stand ... List \$5.00

This small black moulded rubber stand may be used with either the Model 646 or Model 647 microphones. Designed for use where permanent installation is needed or desired. Material, rubber. Dimensions: diameter, 3 3/8 in.; height, 1 in. Weight, 2 oz.







Commercial Airplanes



Trains



Ships



Skating Rinks



Auto and Motorboat Races



Manufacturing Plants

# Electro-Voice

## Differential\* and Special-Purpose Microphones

First to bring broadcast-quality microphones to the P.A. field, Electro-Voice continues its pioneering leadership with a unique line of differential and special-purpose microphones. The most complete line available, E-V Differential and special-purpose microphones offer tremendous advantages under extreme conditions in a wide variety of applications. The exclusive E-V indestructible Acoustalloy nonmetallic diaphragm is utilized in all Electro-Voice dynamic microphones. Extremely rugged construction provides the long-life characteristics that have made Electro-Voice microphones world famous!

**Electro-Voice Differential Microphones** have a noise-cancelling pickup pattern. Sound waves originating from a point more than a few inches away from the microphone enter *both* sides of the case at the same time and cancel each other. When sound source is close to microphone, sound waves do not cancel, resulting in noise-free pickup. Differential microphones are ideal for use in areas of high surrounding noise.

\*Patent No. 2,350,010

# Electro-Voice

## Differential and Special-Purpose Microphones



622SKK  
625SKK

**Model 622SKK Omnidirectional Dynamic Handset**—For paging, intercom and communications. Light, sturdy bakelite; 150-ohm magnetic receiver with response 200 to 4000 cps. Nonshorting press-to-talk switch closes mike and relay circuit. Microphone response, 100 to 5000 cps, output level -55 db. (0 db = 1 mw/10 dynes/cm<sup>2</sup>); RETMA Sensitivity Rating, -147 db. Impedance 250 ohms. 6-foot, 5-conductor cable. Size, 8½ in. x 3 in. x 2¾ in. Net weight, 1 lb. 5 oz. including cable. List Price . . . . . \$78.00

**Model 625SKK Dynamic Differential Handset Microphone**—Noise-cancelling microphone designed for use where background noise is at high level. Enables user to speak in a normal voice. Appearance, other characteristics, and specifications similar to Model 622SKK. Supplied with six-foot, five-conductor, unshielded cable. DPST switch also will handle relay or other remote control in addition to turning on microphone. Press-to-talk button. Size, 8½ in. x 3 in. x 2¾ in. Net weight, 1 lb. 5 oz. including cable. List Price . . . . . \$85.00

**Model 606 Differential Dynamic**—Close-talking, noise-cancelling. Response 100 to 5000 cps. Output, (at ½ in.) -55 db. Acoustalloy diaphragm. Head at 22° fixed tilt. ⅝ in. -27 thread. Built-in MC-1 connector. Satin chromium. 2 in. x 3¼ in. x 2½ in. inc. stud. Impedances; 50 ohms, 250 ohms or Hi-Z. (Specify when ordering.) Low impedances not balanced to ground. 18-foot cable. Net weight, 12 oz. List price . . . . . \$52.50

**Model 600D Dynamic Mobile-Mike**—Lightweight, hand-held, extra-rugged. Output, -55 db. DPDT press-to-talk switch can be used for relay control. Acoustalloy diaphragm. 2¼ in. x 2 in. x 4 in. Impedances; 50 ohms, 250 ohms or Hi-Z. (Specify when ordering.) 5-foot cable. Net weight, less cable, 8 oz. List Price . . . . . \$47.50



606



600D





602



210KK



205KK



205STCKK

# Electro-Voice

## Differential and Special-Purpose Microphones

**Model 602 Differential Dynamic**—Close-talking, noise-cancelling, lightweight, hand-held, extra-rugged. Output, -55 db. DPDT press-to-talk switch can be used for relay control. Acoustalloy diaphragm. 2¼ in. x 2 in. x 4 in. Impedances; 50 ohms, 250 ohms or Hi-Z. (Specify when ordering.) 5-foot cable. Net weight less cable, 8 oz. List Price . . . . . \$57.50

**Model 210KK Carbon**—Similar to Model 600D but single-button carbon. Output, -50 db. DPDT press-to-talk switch can be used for relay control. 5-foot coiled cord. List Price . . . . . \$35.00

**Model 205KK Differential Carbon** — Close-talking, noise-cancelling. Single-button carbon. Maximum intelligibility under high ambient noise. Blastproof, shock-resistant. Output at ¼ in., - 50 db. Black phenolic case. DPDT press-to-talk switch can be used for relay control. 5-foot coiled cord. Size 2¼ in. x 2¼ in. x 4 in. Net weight less cable, 8 oz. List Price . . . . . \$45.00

**Model 205STCKK**—CAA Type approved certificate No. 1040 for commercial aircraft use. Supplied with coiled cord. List Price . . . . . \$56.50



205STCKKP



600TR



602TR



# Electro-Voice

## Differential and Special-Purpose Microphones

**Model 205STCKKP**—Similar to **205STCKK** with WE-309 plug. List Price.....\$61.25

**Model 600TR Microphone**—Has compact, one-stage transistor amplifier built into case. Complete circuit including transistor, transformers, and associated equipment. Output, -21 db. Amplifier power gain approximately 34 db. Can be used as replacement for carbon microphones without circuit modification. Press-to-talk switch also can be used for relay control. Size 2¼ in. x 2 in. x 4 in. Black phenolic case with mounting bracket. 5-foot cable. Net weight less cable, 13 oz. List Price.....\$82.50

**Model 602TR Microphone**—Similar in type and appearance to Model 600TR but designed for close-talking, noise-cancelling work. Speech is clear, crisp, distinct. May be used to replace carbon microphones. Net weight less cable, 13 oz. List Price.....\$93.00

**Model 805 Contact**—For guitar, banjo, any vibrating-string instrument. Hi-Z. Sealed crystal. Chromium finish. 15-foot cable. List Price.....\$20.00

Only Electro-Voice offers you patented\* noise-cancelling DIFFERENTIAL microphones.

\*patent No. 2,350,010



If You Didn't Get This From My Site,  
Then It Was Stolen From...

[www.SteamPoweredRadio.Com](http://www.SteamPoweredRadio.Com) 805



# Electro-Voice

## CDP<sup>®</sup> Speakers

### Your Finest Choice for P. A.



Model 848 CDP

**TWICE THE  
AUDIO RANGE**



Model 847 CDP

**PEAK-FREE  
RESPONSE**

**2½ OCTAVES  
MORE MUSICAL  
RANGE**

**A SINGLE DRIVER AND DIAPHRAGM AND TWO HORNS** comprise Compound Diffraction Projectors. Here is *the same coaxial principle long used in home high-fidelity audio reproducing systems, now yours for P.A.*

**THE SINGLE DIAPHRAGM ACTIVATES A LARGE HORN** for low-frequency reproduction and a second, smaller horn, mounted in the mouth of the large horn, which reproduces high frequencies efficiently to 10,000 cps.

**THE RESULT:** Greater intelligibility and an increase in efficiency of 3 db over multicellular horns, with vastly better sound dispersion. Elimination of cells means no pin-pointing of sound, a characteristic of most conventional public address speakers of the cellular and re-entrant types.

**THE EXTENDED HIGH-FREQUENCY RESPONSE** of CDPs affords more intelligible speech reproduction. If both microphone and amplifier have "flat" response, no equalization is necessary. Higher levels of reproduction are accomplished without feedback.

**TIME WAS WHEN LOW FREQUENCIES REQUIRED LARGE HORNS.** But, Electro-Voice designed its CDP units with a very low taper rate in proportion to the size of the horn mouth to give you maximum bass with minimum bulk.

**CDP's CAN BE MOUNTED** next to and with mouths paralleling wall, ceiling or floor for augmented bass response if desired. Or you can mount two or more with mouths adjacent for mutual loading and a similar effect. You get added power-handling capacity this way, too.

**GREATER  
COVERAGE  
WITH FEWER  
UNITS**

**BLASTPROOF,  
SPLASHPROOF,  
WATERPROOF**

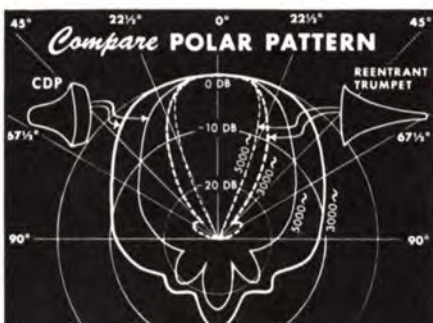
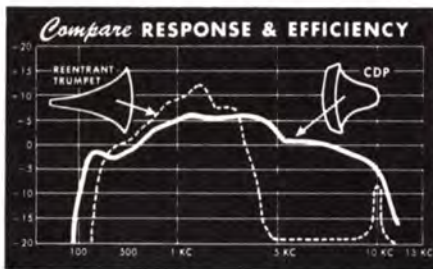



# Electro-Voice

## CDP Speakers

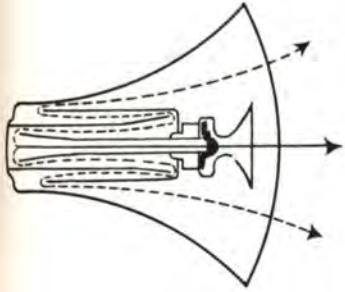

### COAXIAL HORNS

CDP utilizes two coaxially mounted diffraction horns working from both sides of a single diaphragm. Each horn is designed for optimum air loading and reproduction within its own range.

**CDPs PROVIDE BETTER THAN TWICE THE HIGH-FREQUENCY POLAR DISTRIBUTION** of previous projectors of comparable size. Both horns of the CDP are designed to spread sound in the same manner that optical diffraction slits spread light. Therefore, the optimum polar distribution for wide coverage in a horizontal plane is obtained when the long dimensions of both horns are vertical. The most concentrated horizontal polar pattern is obtained with the long dimensions of the horns horizontal. If a very large amount of low-frequency distribution is not necessary, yet wide high-frequency distribution is desired, the large outer horn of the 848 may be mounted horizontally while the small inner horn is mounted vertically. This is the ideal condition for projecting sound to the corners of a room when the CDP is mounted in the middle of a wall.

**ELECTRO-VOICE COMPOUND DIFFRACTION PROJECTORS** Disperse sound through a solid 120° angle when mounted with the long dimensions of the two horns in a vertical position. The wide-angle dispersion of the CDP reduces the number of units needed to cover a specific area. This results in a more economical and efficient installation.

**WHEN A CONCENTRATED POLAR PATTERN OF 90° IS DESIRED,** the CDP should be mounted with the *short* dimension of the two coaxially mounted horns vertically.

**FREQUENTLY,** a feedback peak in an auditorium or outdoor arena is above 1000 cps. In this situation it is advantageous to spread the sound below 1000 cps as much as possible and to concentrate the dispersion of the high frequencies to decrease level at the microphone position. With 848 CDP, this is possible by merely turning the high-frequency horn to the horizontal plane and installing the projector with the long dimension of the bass horn vertical.

**CDP's FUNCTION WITH EXCELLENT RESULTS** under extreme temperature, humidity and vibration conditions—even under water! They're blastproof because there are no sealed cavities on either side of the diaphragm. Large horns are of molded glass fibers, the same bullet-proofing material used by the U.S. armed forces. Color is molded in all the way through the horn.

**THE VOICE COIL AND DIAPHRAGM ASSEMBLY** of the CDP is virtually indestructible under ordinary usage. The diaphragm is formed of glass cloth impregnated with nonhygroscopic phenolic. The voice coil itself is edgewise wound on a nonmagnetic form of tremendous strength, minimum thickness and light weight.

**IF,** under extraordinary circumstances, the 848 diaphragm assembly is damaged, it is replaced simply by unscrewing the high-frequency horn and removing four screws. No soldering is necessary and re-alignment of the diaphragm is automatic.

These are features which resulted in selection of the CDP-type over all other speakers for use on flight decks of Forrestal class U.S. aircraft carriers.

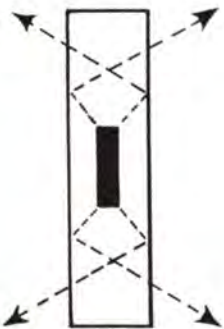

### DIFFRACTION PRINCIPLE

Uses the new Hoodwin Principle, an acoustic application of optical slit diffraction, for perfected smooth sound dispersion virtually independent of frequency.



# Electro-Voice

## CDP the Projector with Widest Range P. A. Reproduction

A folded-horn is essential to give you proper bass response. But the critical taper rate of folded-horn speakers reduces reproduction in the mid and high ranges.

Electro-Voice uses a high-frequency horn to recover these mid-range and high notes — gives you  $2\frac{1}{2}$  more octaves of sound reproduction.

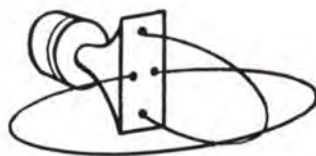
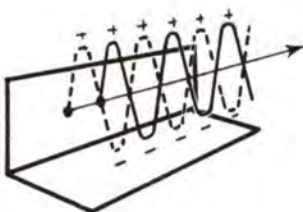
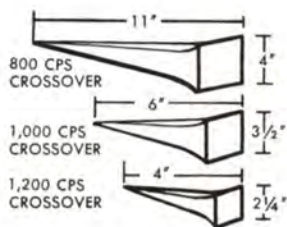
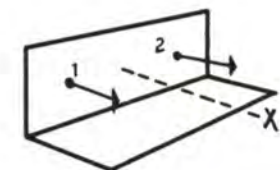
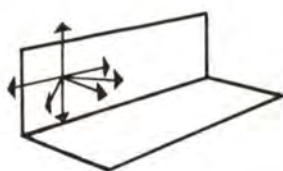

### HOW THE HOODWIN PRINCIPLE OF OPTICAL SLIT DIFFRACTION HORN WORKS

1 Sound disperses equally in all directions from a single-point source.

2 If two sound sources are used, the sound pressures from both sources will be in phase on the axis between the two sources and resultant pressure will be double that produced by a single source.

3 But if the distance between the two points is one half wave-length or greater, the sound from the two sources will be considerably out of phase for most points off the axis, thereby resulting in decreased sound pressure.

4 Any horn mouth can be considered as a group of small point sources of sound.

5 Horns must have a certain length as well as cross-sectional area at the mouth to load the driver down to the lowest frequencies. The lower we go, the longer the horn and the greater must be the mouth area.

6 Narrowing the horizontal area to less than the wavelength of the highest frequency to be reproduced and extending the vertical dimension to preserve the area necessary for loading efficiency results in *WIDE LATERAL DISPERSION* and *REDUCTION OF UNNEEDED VERTICAL DISPERSION ONLY*.



The materials and finishes of the CDP have been chosen to provide excellent durability and weather resistance with a minimum of maintenance.

The bell of the CDP is molded of glass fibers and polyester resin. The resin acts as a binder, while the fibers provide the strength. The light lines visible on the bell are strands of glass fibers next to the surface.

The glass polyester combination produces one of the

strongest reinforced plastics for its weight. It is impervious to all weather conditions and has even been used for pipes carrying salt water. Therefore, it is not necessary to paint or protect the bell, although paint may be applied if desired, for matching the decor. Its color is molded into the full depth of the material and if any scratches occur, they can usually be removed from sight by rubbing with a cloth containing furniture or automotive wax.

## SPECIFICATIONS

	Model 848	Model 847
Rated Input Power	25 watts program, 50 watts peak	12 watts program 24 watts peak
Input Impedance	16 ohms	16 ohms
Acoustical Crossover	1000 cps	1500 cps
Taper Rate	100 cps	210 cps
Response Range	175-10,000 cps	250-10,000 cps
RETMA Sensitivity Rating	52 db	51 db
Dimensions	10½" x 20½" x 20"	11¾" x 7¾" x 10½"
Weight	13½ lbs. net; 15 lbs. shipping	6½ lbs. net; 8 lbs. shipping
List Price	\$75.00	\$46.33

## INSTALLATION REQUIREMENTS FOR MOTION PICTURE THEATRE CONDITIONS

Seating Capacity	Amp. Power	CDP's Required 848	CDP's Required 847
750	20 watts	1	2
1500	30 watts	2	4
3000	60 watts	3	6
6000	80 watts	4	8

For roller skating rinks, factories and out-of-door conditions of high ambient noise . . . triple the amplifier power and number of CDP units required for a motion picture theater of comparable area as shown above.

## CDP ACCESSORIES

**CDP Model 876**—25-watt Line Matching Transformer: In protective case for mounting on rear of the Electro-Voice Model 848 system. Primary taps for 25, 15, 10 and 2.5 watts with 70-volt line. Impedance taps of 45, 200, 500, 1000 and 2000 ohms. Transformer bypasses frequencies below Model 848 horn cutoff. Case extends 3½ in. behind projector when mounted. 5¼ in. maximum diameter. Weight: Net, 3 lbs.; Shipping, 4 lbs. List Price, Model 876 . . . . . \$16.50

**MODEL 877**—25-watt Line Matching Transformer and Overload Protector: Same as above, but with added full-range thermal bimetallic relay for maximum protection against overload. Size: Same dimensions as Model 876 Transformer. Weight: Net, 3 lbs.; Shipping, 4 lbs. List Price, Model 877 . . . \$17.50

**MODEL 879**—Joining Kit: For fastening multiple projectors together in any array; use on joining kit, Model 879, for each junction between two horns. Weight: Net, 8 oz.; Shipping, 1 lb. List Price, Model 879 . . . . . \$2.75

**MODEL 870**—12-Watt Line Matching Transformer for mounting on side of CDP Model 847. Primary taps for 12, 8, 4, 2 and 1 watts with 70 volt line. Impedance taps for 45, 500, 2500 and 5000 ohms. Size: 2½ in. x 2½ in. x 3 in.; Shipping Weight: 2 lbs. List Price, Model 870 . . . . . \$12.00





# How to buy *Electro-Voice* Microphones

Microphones should be ordered from your nearest Electro-Voice microphone distributor. He stocks and displays these units at all times, insuring you prompt delivery and immediate service.

There are over 1200 of these Electro-Voice

microphone distributors throughout the United States and Canada, supervised directly by factory field representatives at the following regional offices. Please call any of the offices shown below for the address of the nearest distributor serving your area, and for further information.

## Electro-Voice Regional Offices - Factory Field Representatives:

### **CALIFORNIA, Burbank**

I. R. Stern  
4109 Burbank Road  
Ph: Victoria 9-1195

### **CALIFORNIA, San Francisco**

Meyer and Ross  
113 - 10th Street  
Ph: Hemlock 1-0652

### **COLORADO, Denver**

McLoud and Raymond  
5528 E. Colfax Avenue  
Ph: Florida 5-3525

### **GEORGIA, Atlanta 3**

Maitland K. Smith  
208 14th Street N. E.  
Ph: Trinity 5-8031

### **ILLINOIS, Harvey**

Dayton Warner  
15423 Honore Avenue  
Ph: Edison 1-6247

### **INDIANA, Indianapolis**

Harrison Blind  
1508 Winton Avenue  
Ph: Chapel 4-0191

### **L. I., N. Y., Port Washington**

Carduner Sales Corp.  
80 Shore Road  
Ph: P. W. 7-7700

### **MASS., Boston 9**

Anderson Sales Co.  
177 State Street  
Ph: Capitol 7-2980

### **MICH., Detroit 27**

Wayne Beitel  
13209 Fenkell  
Ph: Vermont 8-9100

### **MINN., Minneapolis 16**

Marvin Kirkeby  
1300 France, South  
Ph: Franklin 7-3239

### **MO., Kansas City 2**

R. W. Farris Co.  
406 West 34th Street  
Ph: Logan 1-7495

### **NEW JERSEY, Newark 2**

Art Cerf Co.  
744 Broad Street  
Ph: Mitchell 2-6734

### **NEW YORK, New York 16**

Rocke International Corp.  
13 East 40th Street  
Ph: Murray Hill 9-0200

### **OHIO, Columbus 21**

C. L. Pugh  
2144 Riverside Drive  
Ph: Hudson 8-4855

### **TEXAS, Dallas 26**

Jack Yount  
2731 Taylor Street  
Ph: Riverside 8-2158

### **WASH., Seattle 1**

Wm. R. Lanphear Co.  
3215 Western Avenue  
Ph: Murdock 8150

E-V of Canada:

### **ONTARIO, Scarborough**

R. C. Kahnert Sales Co.  
73 Crockford Boulevard  
Ph: Redfern 7078

### **CANADA, Vancouver, B. C.**

D. Eldon Mc Lennan  
1624 West 3rd Avenue  
Ph: Bayview 2898

# Electro-Voice

... the most  
complete line  
for the audio  
industry

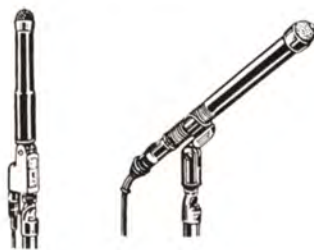

• Microphones for broadcast and TV



• Microphones for public address, recording, and general communications.

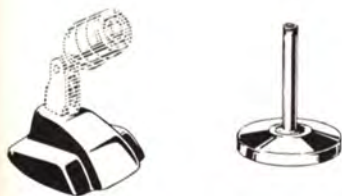

• Microphone accessories.

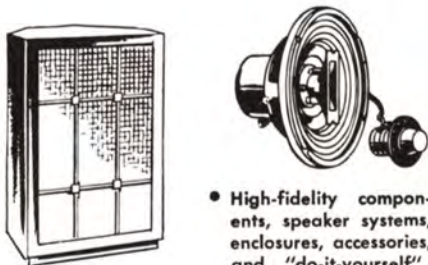

• High-fidelity components, speaker systems, enclosures, accessories, and "do-it-yourself" speaker enclosure kits.

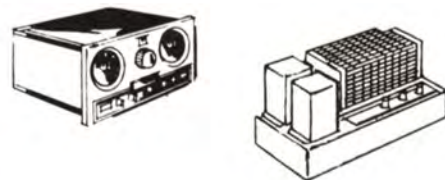

• High-fidelity amplifiers, preamplifiers, FM-AM tuners.



• Public-address loudspeakers.



• Phonograph cartridges.

## RME<sup>®</sup>

A Respected Name  
in Communications

COMPLETE INFORMATION ON ANY ELECTRO-VOICE PRODUCT ON REQUEST



*Electro-Voice*

**No Finer Choice  
than Electro-Voice**

**ELECTRO-VOICE, INC.  
BUCHANAN, MICHIGAN**

E-V of Canada Ltd., 73 Crockford Boulevard,  
Scarborough, Ontario

-If You Didn't Get This From My Site,  
Then It Was Stolen From...  
[www.SteamPoweredRadio.Com](http://www.SteamPoweredRadio.Com)