

OPERATING INSTRUCTIONS



TYPE 1390-B

**RANDOM-NOISE
GENERATOR**

1390-B

G E N E R A L R A D I O C O M P A N Y

OPERATING INSTRUCTIONS

TYPE 1390-B

RANDOM-NOISE GENERATOR

Form 1390-0100-K
November, 1965

G E N E R A L R A D I O C O M P A N Y
WEST CONCORD, MASSACHUSETTS, USA

SPECIFICATIONS

Frequency Range: 5 c/s to 5 Mc/s.

Output Voltage: Maximum open-circuit output is at least 3 V for 20-kc range, 2 V for 500-kc range, and 1 V for 5-Mc range.

Output Impedance: Source impedance for maximum output is approximately 900 Ω . Output is taken from a 2500- Ω potentiometer. Source impedance for attenuated output is 200 Ω . One output terminal is grounded.

Range	Typical Spectrum Level (with 1-V, rms, output)	Spectrum Level Uniformity*
20 kc/s	5 mV for 1-cycle band	within ± 1 dB, 20 c/s to 20 kc/s
500 kc/s	1.2 mV for 1-cycle band	within ± 3 dB, 20 c/s to 500 kc/s
5 Mc/s	0.6 mV for 1-cycle band	within ± 3 dB, 20 c/s to 500 kc/s; within ± 8 dB, 500 kc/s to 5 Mc/s

* Noise energy also present beyond these limits. Level is down 3 dB at 5 c/s. See plot.

Waveform: Noise source has good normal, or Gaussian, distribution of amplitudes for ranges of the frequency spectrum that are

narrow compared to the band selected. Over wide ranges the distribution is less symmetrical because of dissymmetry introduced by the gas tube. Some clipping occurs on the 500-kc and 5-Mc ranges.

Voltmeter: Rectifier-type averaging meter measures output. It is calibrated to read rms value of noise.

Attenuator: Multiplying factors of 1.0, 0.1, 0.01, 0.001, and 0.0001. Accurate to $\pm 3\%$ to 100 kc/s, within $\pm 10\%$ to 5 Mc/s.

Power Required: 105 to 125 or 210 to 250 V, 50 to 400 c/s, 50 W.

Accessories Supplied: TYPE CAP-22 Power Cord, spare fuses.

Accessories Available: Rack-adaptor panel (panel height 7 in).

Mechanical Data: Convertible-Bench Cabinet

Width		Height		Depth		Net Weight		Shipping Weight	
in	mm	in	mm	in	mm	lb	kg	lb	kg
12 $\frac{3}{4}$	325	7 $\frac{1}{2}$	190	9 $\frac{3}{4}$	250	12	5.5	16	7.5

For additional information, ask for General Radio Reprint E-110.

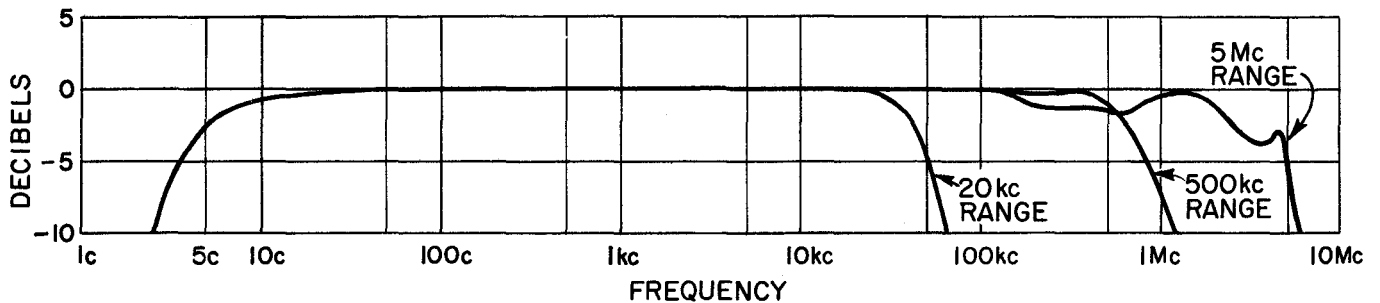

TABLE OF CONTENTS

Section 1 INTRODUCTION	1
1.1 Purpose	1
1.2 Description	1
Section 2 THEORY OF OPERATION	2
2.1 General	2
2.2 Output Voltage	2
2.3 Characteristics of Noise Output	2
2.4 Departures of Output from True Randomness	4
2.5 Frequency Spectrum of Noise	4
2.6 Analysis of Noise by Constant-Percentage Analyzers	4
2.7 Type 1390-P2 Pink-Noise Filter	4
Section 3 INSTALLATION	6
3.1 Bench Mounting	6
3.2 Relay-Rack Mounting	6
3.3 Power Supply Connection	6
Section 4 OPERATING PROCEDURE	6
4.1 Start-Up	6
4.2 Frequency Control	6
4.3 Output Control	6
4.4 Voltmeter	6
4.5 Load	7
4.6 Hum	7
4.7 Applications	7
Section 5 SERVICE AND MAINTENANCE	11
5.1 General	11
5.2 Access to Components	11
5.3 Preliminary Checks	11
5.4 Meter Does Not Read	11
5.5 Tube Replacement	11
5.6 Heater Voltage of Type 6D4 Gas Tube	11
5.7 Voltage Measurements	11
PARTS LIST	13

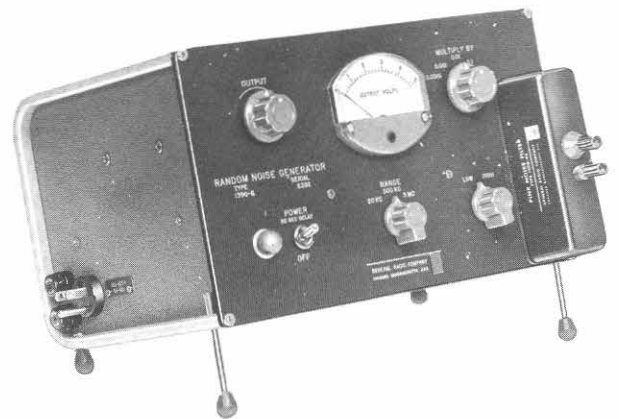
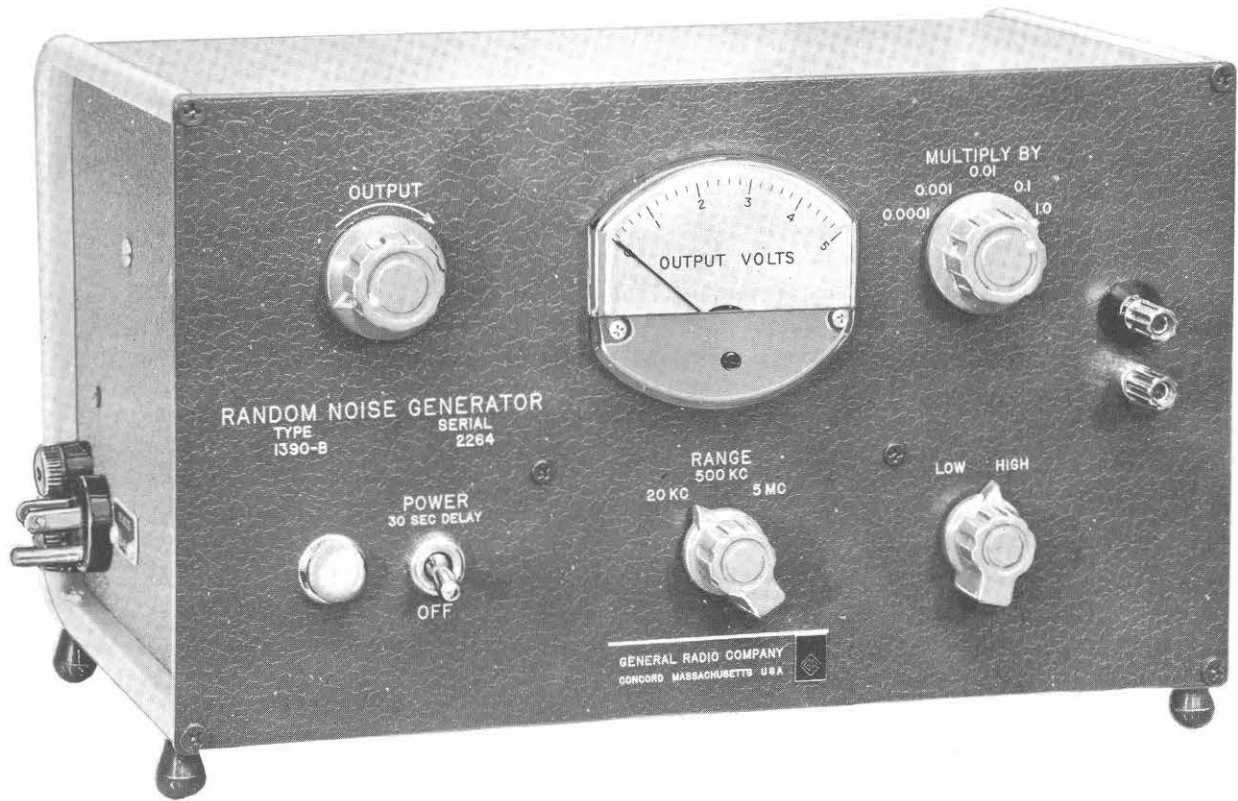

Figure 1. Type 1390-B Random-Noise Generator. (See Section 3 for different mounting arrangements). View at lower right shows Type 1390-P2 Pink-Noise Filter mounted on the generator.

TYPE 1390-B RANDOM-NOISE GENERATOR

Section 1 INTRODUCTION

1.1 PURPOSE. The Type 1390-B Random-Noise Generator (Figure 1) provides a high level of electrical noise at its output terminals. This type of signal is useful in room acoustic measurements, loudspeaker and microphone tests, psychoacoustic tests, filter tests, cross-talk measurements for multichannel carrier systems, calibration checks on recording systems, modulation of signal generators and test oscillators, tests of rms response of meters, observation of resonance in systems, electrical averaging of resonant responses, and comparisons of effective band width. A pair of these genera-

tors can be used as signal sources for demonstration of various degrees of correlation, possible errors of random sampling, and other concepts of statistical theory.

1.2 DESCRIPTION.

1.2.1 CONNECTIONS. Two jack-top binding posts, used as output terminals, are provided on the panel of the Type 1390-B Random-Noise Generator.

1.2.2 CONTROLS. The following controls are on the panel of the Type 1390-B Random-Noise Generator:

Name	Description	Positions	Use
RANGE	3-position rotary selector switch	20 kc, 500 kc, 5 Mc	Selects network used for shaping noise spectrum.
POWER	2-position toggle switch	OFF, POWER	Energizes instrument.
None	2-position rotary selector switch	LOW, HIGH	In LOW position, introduces a 10:1 resistance pad after gas-tube noise source to reduce effect of amplitude limitations of amplifier and to reduce noise field radiated by the instrument.
OUTPUT	Continuous rotary control		Varies output voltage.
OUTPUT VOLTS	Rectifier-type, averaging voltmeter		Indicates rms value of noise at output terminals.
MULTIPLY BY	5-position rotary selector switch	0.0001, 0.001, 0.01, 0.1, 1.0	Attenuates output voltage.

Section 2

THEORY OF OPERATION

2.1 GENERAL. (See Figure 2.) The Type 1390-B Random-Noise Generator uses a gas-discharge tube as its noise source. A transverse magnetic field is applied to the tube to eliminate the oscillations usually associated with a gas discharge and to increase the noise level at high frequencies¹. The noise output from the gas tube is amplified in a two-stage amplifier. Between the first and second stages the noise spectrum is shaped in one of three different ways, depending on the setting of the RANGE switch. At the 20-kc position, a low-pass filter is inserted, which has a gradual roll-off above 30 kc, with the audio range to 20 kc uniform in spectrum level. At the 500-kc setting, a low-pass filter is inserted, which rolls off above 500 kc. At the 5-Mc setting, a peaking network is used. This network approximately compensates for the drop in noise output from the gas tube at high frequencies, so that a reasonably good spectrum is obtainable to 5 Mc.

2.2 OUTPUT VOLTAGE. The maximum open-circuit output voltage on the 20-kc band is at least 3 volts, on the 500-kc band at least 2 volts, and on the 5-Mc band at least 1 volt. This corresponds to a relatively high noise level, since the output impedance at maximum output is only about 900 ohms. This level can be expressed in terms of the resistance noise corresponding to 900 ohms at room temperature. The rms voltage in a one-cycle band due to thermal agitation in a 900-ohm resistor at room temperature is about 3.8×10^{-9} volt. The level from the Type 1390-B Random-Noise Generator is about five millivolts for a one-cycle band when there is a total output voltage of one volt on the 20-kc band. This level, then, is about 1,300,000 times the corresponding voltage for resistance noise,

or about 122 decibels above resistance noise at the same impedance level.

2.3 CHARACTERISTICS OF NOISE OUTPUT. As shown in Figure 3, no regular pattern appears in the output waveform; it is characterized by randomness rather than by regularity. Noise is therefore described by statistical means,² and is characterized by its distribution of instantaneous amplitudes and by its frequency spectrum.

A random noise is often defined as a noise that has a "normal" or "Gaussian" distribution of amplitudes. This concept is illustrated by the following simple experiment performed with the noise generator.

Set the noise generator to the 20-kc band and to maximum output. Connect a small capacitor (about 1000 pf) across the output. Suddenly disconnect the capacitor. Measure its voltage with an electrometer or

¹ J. D. Cobine and J. R. Curry, "Electrical Noise Generators", Proc. IRE, Vol. 35, No. 9, September 1947, pp. 875-879.

² S. O. Rice, "Mathematical Analysis of Random Noise", Bell System Technical Journal, Vol. 23, No. 3, July 1944, pp. 282-332; Vol. 24, No. 1, January 1945, pp. 46-156.

A. van der Ziel, Noise, New York, Prentice-Hall, Inc., 1954.

W. B. Davenport, Jr. and W. L. Root, An Introduction to the Theory of Random Signals and Noise, New York, McGraw-Hill, 1958.

W. R. Bennett, Electrical Noise, New York, McGraw-Hill, 1960.

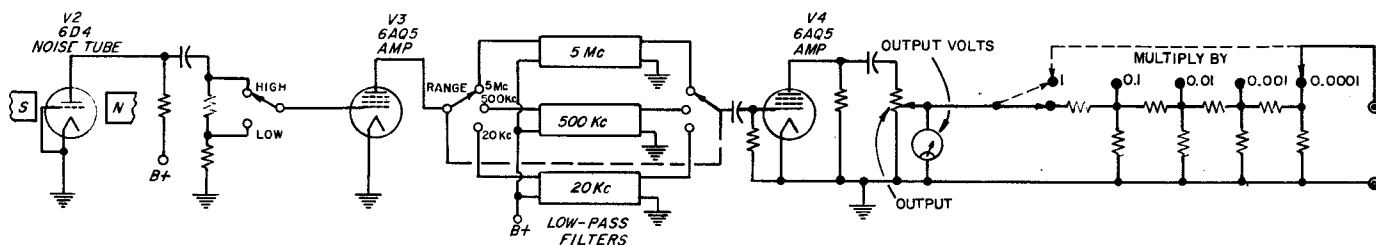

Figure 2. Elementary Circuit Diagram.

TYPE 1390-B RANDOM-NOISE GENERATOR

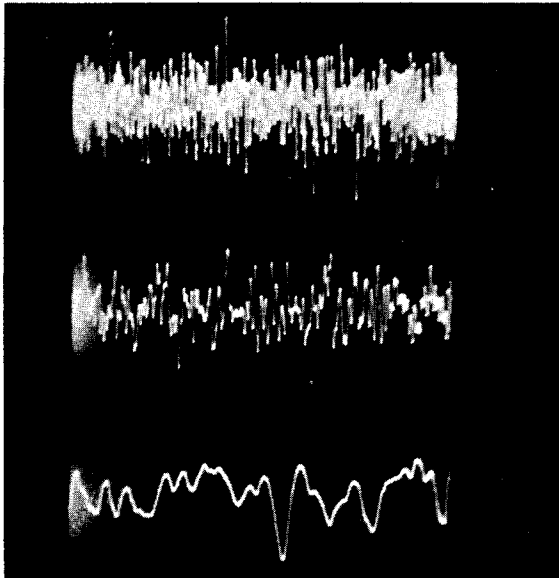

Figure 3. Oscillograms of Three Different Samples of the Output Voltage Wave. (A single sweep was used for each. Middle trace is at four times, and lower trace 20 times sweep speed of upper trace.)

its charge with a ballistic galvanometer. Record this value, which is the instantaneous amplitude of the noise voltage at the time the capacitor is disconnected. A series of these values can be obtained, and a graph prepared, with instantaneous amplitude versus the percentage of time during which any amplitude is exceeded. A large number of amplitudes must be determined in this way before a reliable distribution results. Two or three hundred observations are usually sufficient to show the trend for demonstration purposes, while several thousand will give a reliable curve for the important part of the range. Because of the large number of observations required, automatic apparatus is helpful in making these determinations.³

Figure 4 illustrates a chart made up after 400 observations. This chart shows the fraction of observations in each interval of 0.2 volt. It is seen that most of the observations were relatively low values, although some relatively high values were observed. These results are also shown in a qualitative way in the oscillograms in Figure 3.

³ McKnurdzon, "Experimental Study of Statistical Characteristics of Filtered Random Noise", Technical Report No. 115, M.I.T. Research Laboratory of Electronics, July 15, 1949.

L. W. Orr, "Wide-Band Amplitude Distribution Analysis of Voltage Sources", Review of Scientific Instruments, Vol. 25, No. 9, Sept., 1954, pp. 894-898.

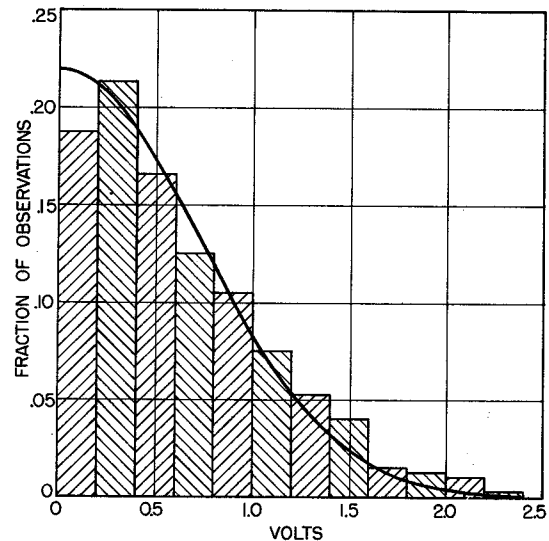

Figure 4. Results of Voltage-Sampling Experiment. (Continuous curve is a normal probability distribution curve adjusted according to r-m-s value of noise voltage and size of intervals used in plot.)

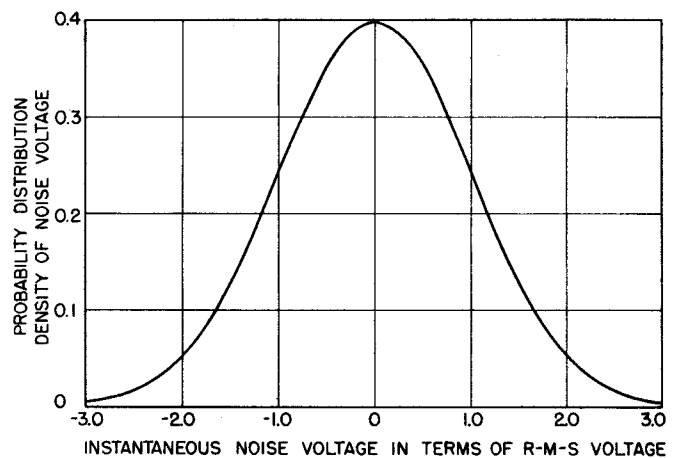

Figure 5. Normal Distribution Curve of True Random Noise.

The normal (Gaussian or Laplacian) distribution curve is also shown in Figure 4. It has been adjusted according to the computed r-m-s value of the data (the standard deviation) and the size of the interval used in plotting the data. The experimental data fit the normal curve very closely. Departures from the normal curve are almost entirely the result of so few observations. Had more observations been made, the result would have been even closer to the expected values.³

In Figure 5, the probability that a voltage between two limits will be observed is given by the area under the normal curve between those two limits. Ex-

pressed in other terms, if the output voltage is observed over long periods of time, the fraction of the total time that the voltage is between the two voltage limits is given by the corresponding area under the probability curve.⁴ For example, the instantaneous voltage magnitude will be no more than one-tenth the r-m-s value for about eight percent of the time, and will be greater than three times the rms value only about 0.26 percent of the time.

2.4 DEPARTURES OF OUTPUT FROM TRUE RANDOMNESS. The curve in Figure 5 is a theoretical curve and is symmetrical about the origin. The noise of the generator has a similar distribution, but is somewhat asymmetrical because of the gas tube. In addition, the inherent amplitude limitations of the vacuum-tube amplifiers limit the distribution curve at high levels. Clipping is most serious on the 500-kc and 5-Mc ranges. When a narrow-band filter is used at the output, the distribution becomes more nearly random.

2.5 FREQUENCY SPECTRUM OF NOISE. The meaning of the term "frequency spectrum of noise" is illustrated in the following experiment; If a wave analyzer, such as the Type 1900-A, set to a 50-cps bandwidth, is used to analyze the output of the noise generator, a fluctuating meter reading will be observed at any setting of the analyzer. If an average value of this reading is taken over a period of time, this average value is an estimate of the level in that 50-cycle-wide band. This level, determined on any ranges of the noise generator, is essentially independent of the frequency setting of the Type 1900-A Wave Analyzer. Thus the spectrum in this region is uniform. The relative spectrum on the noise can be determined by the use of suitable analyzers to cover the full range of the principal energy regions of the noise. A typical result of such an analysis is shown in Figure 6 for the three bands of the Type 1390-B Random Noise Generator. When the spectrum is uniform over a broad band, as shown in Figure 6, it is commonly called "white noise". The "whiteness" always applies to a definite band only. For example, if the noise spectrum is uniform from 100 to 500 kc, the noise is referred to as white in that band.

It is customary to adjust the measured value of analyzed noise to that corresponding to an ideal filter of one-cycle band width. Since noise voltage increases as the square root of the band width, the value determined on the Type 1900-A Wave Analyzer is then divided by $\sqrt{\frac{50 \text{ cycles}}{1 \text{ cycle}}}$ to obtain what is called "spectral voltage density". This can be defined as the

⁴ E. R. Neinburg and T. F. Rogers, "Amplitude Distribution Analyzer", Radio-Electronic Engineering, Vol. 46, No. 6, December 1951, pp. 8-10.

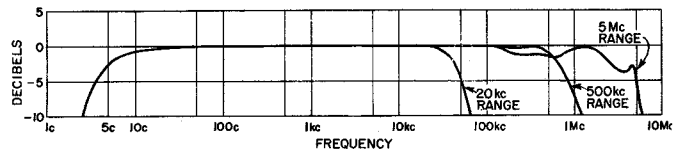

Figure 6. Typical Spectrum Level Characteristics for Type 1390-B Random-Noise Generator.

rms voltage corresponding to the energy contained within a band one cycle per second wide.

NOTE

"Spectral voltage density", although a convenient term, is sometimes not used because most work on noise deals with energy level. The transfer from one to the other requires a knowledge of the impedance level in the circuit. It should be remembered that separate noise signals add on an energy basis and that the noise energy increases directly with the noise bandwidth, while the noise voltage increases as the square root of the bandwidth. Furthermore, the concept used here assumes a uniform density of the noise signal over the band of the analyzer. It should not be used for discrete components.

2.6 ANALYSIS OF NOISE BY CONSTANT-PERCENTAGE ANALYZERS. If the output of the Type 1390-B Random-Noise Generator is analyzed by a Type 1564-A Sound and Vibration Analyzer, the results will be similar to those shown in Figure 7. Here the indicated level increases 10 decibels for each decade increase in frequency. This result can be understood by realizing that this analyzer has a bandwidth that is essentially a constant percentage of the center frequency. For example, at 5 kc the effective band width for noise is about 160 cps, and at 500 cps is about 16 cps.

2.7 TYPE 1390-P2 PINK-NOISE FILTER.

2.7.1 DESCRIPTION. The Type 1390-P2 Pink-Noise Filter (Figure 8) converts the electrical noise output

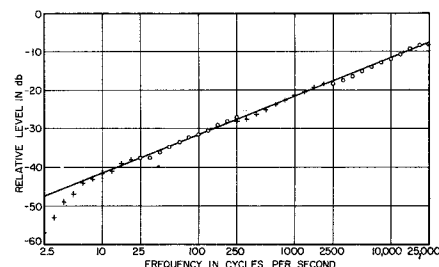

Figure 7. Results of Analysis of Noise-Generator Output Voltage by a Type 1564-A Analyzer. (Straight line drawn at slope of 10 db per frequency decade.)

TYPE 1390-B RANDOM-NOISE GENERATOR

of the Type 1390-B Random-Noise Generator to "pink noise" (constant energy per octave) which facilitates measurements with constant-percentage-bandwidth analyzers. It is designed to plug into the output binding posts of the Type 1390-B Random-Noise Generator, but can also be used at any point in a system where this filter characteristic is needed. The filter is an RC low-pass filter with a slope of -3 db per octave from 20 cycles to 20 kc and a slope of -6 db at higher frequencies (See Figure 9). For shielding, the case of the filter is grounded to the LO input and output terminals. Figure 10 is a schematic diagram of the filter. The input terminals of the Type 1390-P2 Filter are recessed plugs at the rear and the output terminals are binding posts on the front.



Figure 8. Type 1390-P2 Pink-Noise Filter.

2.7.2 USE WITH THE TYPE 1390-B RANDOM-NOISE GENERATOR. Plug the Type 1390-P2 Pink-Noise Filter into the output terminals of the Type 1390-B Random-Noise Generator. The impedance of the load connected to the output terminals of the filter should not be less than 20 kilohms.

On the Random-Noise Generator, set the RANGE switch to 20 kc, the LOW-HIGH switch to HIGH, and the MULTIPLY BY switch to 1.0. The output of the Pink-Noise Filter will be approximately 30 db below its input and the level in each one-third-octave band will be approximately 17 db below that. Thus, when the output meter of the Random-Noise Generator indicates 3 volts, the output of the filter will be approximately 0.1 volt and the level in each one-third-octave band will be approximately 15 millivolts.

2.7.3 USE IN OTHER APPLICATIONS. When the Type 1390-P2 Pink-Noise Filter is used in a system at some point other than the output terminals of the Random-Noise Generator, the input source to the filter should have an impedance of less than 1 kilohm. Input connections can be made with clip leads or Type 274-MB Double Plugs to the recessed input terminals. The impedance of the load connected to the output terminals should not be less than 20 kilohms.

2.7.4 FREQUENCY-RESPONSE MEASUREMENTS. In many acoustical systems, frequency response measurements made with a sine-wave tone source are difficult to interpret because of the large amplitude fluctuations

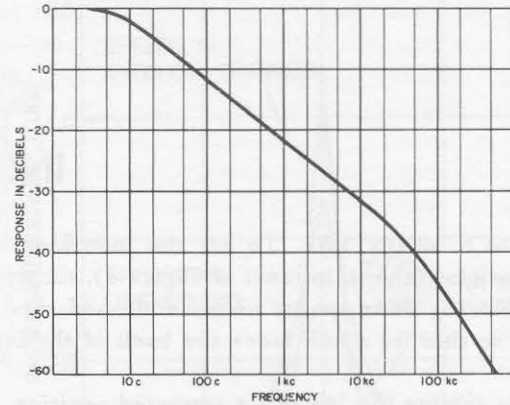

Figure 9. Typical frequency response of the Type 1390-P2 Pink-Noise Filter.

that may occur. When the measurements are made by effectively averaging the data over a narrow range of frequencies, response curve is considerably smoother and much easier to use. In the past, "warble tones" have been used for this purpose. A more convenient method, however, is to use pink-noise as the tone source and a constant-percentage-bandwidth analyzer (such as the Type 1564-A Sound and Vibration Analyzer) with one-third octave bandwidth as the frequency-determining element in the receiving system.⁵ The results of these frequency-response measurements can be conveniently recorded on the Type 1521 Graphic Level Recorder.⁶

2.7.5 USE AS A NOISE SIMULATOR. Some noises that occur in nature are closer in spectral characteristics to pink noise than to white noise. This is true, for instance, of the low-frequency noise in semiconductors and of some acoustical background noises. To simulate electrical signals generated in such cases, it is convenient to use pink noise.

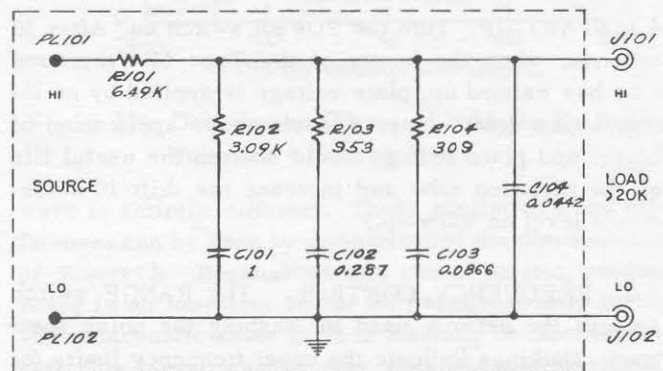

Figure 10. Schematic diagram of the Pink-Noise Filter.

⁵"A New Analyzer for Sound and Vibration", *General Radio Experimenter*, Volume 33, Number 12, December, 1959.

⁶"A Graphic Level Recorder with High Sensitivity and Wide Ranges", *General Radio Experimenter*, Volume 33, Number 6, June, 1959.

Section 3

INSTALLATION

3.1 BENCH MOUNTING. To set the instrument in a tilted position (shown in inset of Figure 1), simply pull each front leg down as far as possible and then turn the leg so that its notch faces the back of the instrument.

To restore the leg to its retracted position, turn it to release the catch and push the leg up.

3.2 RELAY-RACK MOUNTING. Type 480-P412 Panel Extensions are available to adapt the Type 1390-B Random-Noise Generator for relay-rack mounting. To mount the Type 1390-B Random-Noise Generator in a relay rack, first attach the two panel extensions to the instrument. Remove the two screws in the upper and lower corners on one side of the panel. These screws fasten the panel to the aluminum end frames. Place one of the extensions in the front of the panel so that the corner holes on the plate line up with those on the instrument and replace the two screws.

Attach the second extension on the other side of

the instrument panel in the same manner. The instrument can then be mounted in a standard 19-inch relay rack.

3.3 CONNECTION TO POWER SUPPLY. Connect the Type 1390-B to a source of power as indicated by the legend at the input socket at the rear of the instrument, using the power cord provided. While instruments are normally supplied for 115-volt operation, the power transformer can be reconnected for 230-volt service (see schematic diagram, Figure 12). When changing connections, be sure to replace line fuses with those of current rating for the new input voltage (refer to Parts List). Appropriate measures should be taken so that the legend indicates the new input voltage. On instruments changed from 230 to 115 volts, this simply means removal of the 230-v nameplate; a 115-v legend is marked beneath. For instruments changed to 230 volts, a nameplate (Type 5590-1664) may be ordered from General Radio.

Section 4

OPERATING PROCEDURE

4.1 START-UP. Turn the POWER switch on. After 30 seconds, when the heater of the Type 6D4 thyratron tube has warmed up, plate voltage is applied by an internal time-delay relay. (Simultaneous application of heater and plate voltage would shorten the useful life of the thyratron tube and increase the drift in noise-output level on warm-up.)

4.2 FREQUENCY CONTROL. The RANGE switch selects the network used for shaping the noise spectrum. Markings indicate the upper frequency limits for which the noise spectrum is reasonably uniform.

4.3 OUTPUT CONTROL. Output controls are a switch for selecting LOW or HIGH output, an OUTPUT level control, and an output attenuator. In the LOW position, the switch introduces a 10:1 resistance pad after the gas-tube noise source. This reduces the effect of the

unavoidable amplitude limitations of the vacuum-tube amplifier and also reduces the noise field radiated externally by the instrument. To keep hum and microphonics to a minimum, however, it is generally advisable to operate the instrument in the HIGH position.

The OUTPUT level control is a continuous-type control that is used to vary the output voltage from a very low value to maximum for either setting of the output switch.

The MULTIPLY BY switch is used to provide low output levels. It has multiplying factors of 1.0, 0.1, 0.01, 0.001, and 0.0001.

4.4 VOLTMETER. A rectifier-type, averaging meter measures the output voltage. It is calibrated to indicate the rms value of the noise. When the MULTIPLY BY switch is at 1.0, the meter indicates directly the open-circuit voltage at the output terminals. In the other positions of the MULTIPLY BY switch, the open-

TYPE 1390-B RANDOM-NOISE GENERATOR

circuit output voltage is the product of the meter reading and the multiplier reading.

The spectral voltage density of the noise at a given frequency is the r-m-s voltage corresponding to the energy contained within a band 1-cps wide centered on that frequency. The typical spectral voltage density at 1 kc with one volt output is approximately as follows:

- (a) 20-kc band: 5 millivolts for one-cycle band.
- (b) 500-kc band: 1.2 millivolts for one-cycle band.
- (c) 5-Mc band: 0.6 millivolt for one-cycle band.

When an accurate value is desired at any frequency, it should be measured. The values given are intended only as a guide.

4.5 LOAD. The output is taken from a 2500-ohm potentiometer, and one output terminal is grounded. For a truly resistive load with the MULTIPLY BY switch at 1.0, the apparent source impedance is zero when a reading of the voltmeter is taken with the load connected, since the voltmeter reads the voltage across the load. As the output control is varied from the maximum to the minimum setting, the actual source impedance varies from about 900 ohms to nearly zero. When the MULTIPLY BY switch is in any position other than 1.0, the source impedance is 200 ohms.

A load that is not independent of frequency will affect the frequency spectrum of the output noise. For example, a capacitor shunted across the output terminals will decrease the level of the high-frequency noise more than it decreases the level of the noise at low frequencies. The voltmeter is then less indicative of the spectrum level than it is for a resistive load.

4.6 HUM. The hum level is usually more than 40 db below the over-all noise level in the HIGH output position. This hum level is sufficiently low so that for most applications there is no effect from hum, even when an analyzer with a narrow band is used for analysis. The relative hum level in the HIGH output position is lower than that in the LOW position.

4.7 APPLICATIONS.

4.7.1 GENERAL. Some applications of a noise generator depend on its amplitude distribution characteristics (Figures 4 and 5.) For example, the amplitude distribution is similar to that of speech, music, and many other sounds or electrical disturbances that occur naturally⁷, while the amplitude distribution of a sine

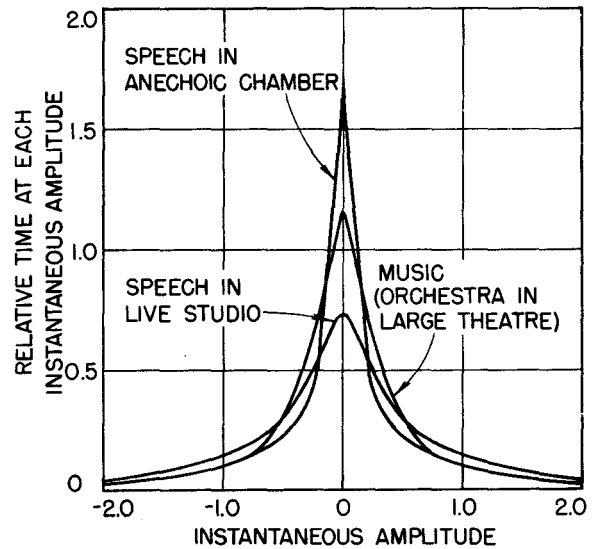

Figure 11a. Amplitude Distribution Curves for Various Sounds. (Curves labeled "Speech" are for particular cases of sounds produced from readings of printed matter⁵; curve labeled "Music" is an analysis of an orchestral selection made in a large theater⁵.)

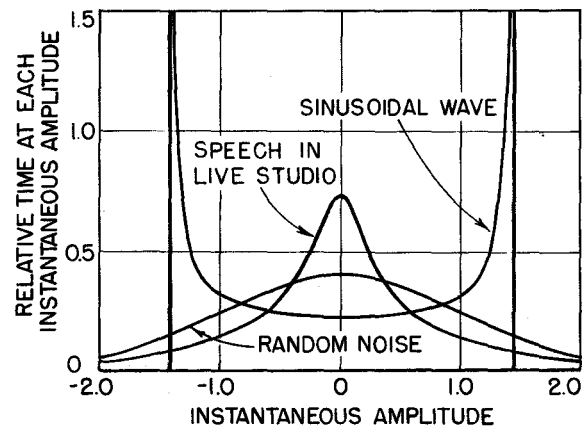

Figure 11b. Distribution Curves of a Single Sinusoidal Wave and a Random Noise.

wave is entirely different. These similarities and differences can be seen by comparison of the distributions of Figure 11. Because of this characteristic, random noise is an important signal for psychoacoustic tests. Psychoacoustic tests include masking or interference tests, loudness measurements, determination of critical bandwidths, and audiometric tests. The techniques used in making such tests are discussed in the various numbers of the Journal of the Acoustical Society

⁷ H. K. Dunn and S. D. White, "Statistical Measurements on Conversational Speech", Journal of the Acoustical Society of America, Vol. 11, No. 3, January 1940, pp. 278-288.

W. B. Davenport, Jr. "A Study of Speech Probability Distributions", M.I.T. Laboratory of Electronics, Technical Report No. 148, August 25, 1950.

GENERAL RADIO COMPANY

of America (for which there are two comprehensive indexes available) and in various psychological journals. A useful bibliography for these applications is S. S. Stevens, J. G. S. Loring, and Dorothy Cohen, Bibliography on Hearing, Harvard University Press, Cambridge, 1955, particularly those references listed in Sections 139 (p. 571), 157 (p. 573) and 222-228 (pp. 579 f).

Other applications depend on the various possible frequency spectra of noise. The frequency spectrum is independent of the amplitude distribution, in the sense that a normal distribution of amplitudes is possible with any frequency spectrum - flat, broad, narrow, sloping, or peaked. Systems that affect one characteristic, however, may also affect the other. For example, nonlinear clipping affects both the amplitude distribution and the frequency spectrum. Linear filter networks used on purely random noise do not affect the randomness but alter the frequency characteristic and correspondingly the time scale. Linear filter networks used after clipped noise alter the frequency spectrum and also tend to make the noise more nearly random.

4.7.2 ELECTROACOUSTIC TESTS. The Type 1390-B Random-Noise Generator is a useful signal source for many types of electroacoustic tests, including loud-speaker-response tests. Some useful discussions of these tests using a noise source are given in the following: Leo. L. Beranek, Acoustic Measurements, New York, John Wiley and Sons, 1949, pp. 639-640, 665 f, 697-702; and RMA Standard SE-103, Speakers for Sound Equipment, April 1949, p. 6, Standard Test Signal BA.

Other General Radio instruments useful in electroacoustic tests are the Type 1551 Sound-Level Meter, the Type 1551-P1 Condenser Microphone System, the Types 1550-A and 1558 Octave-Band Noise Analyzers, the Type 1564-A Sound and Vibration Analyzer, and the Type 1521 Graphic Level Recorder.

4.7.3 ROOM ACOUSTICS TESTS. The noise generator is a useful signal source for many types of tests in room acoustics. These include reverberation tests, panel (wall and floor) transmission measurements, measurement of space irregularities, and measurement of steady-state signal transmission. For details, consult the following: Leo. L. Beranek, Acoustic Measurements, New York, John Wiley and Sons, 1949, pp. 804 ff, 826 f, 831 and 883.

The Type 1551-B Sound-Level Meter, the Types 1550-A and 1558-A Octave-Band Analyzers, the Type 1564-A Sound and Vibration Analyzer, and the Type

1521 Graphic Level Recorder are useful elements in the over-all set-up for these tests.

4.7.4 STATISTICAL DEMONSTRATIONS. The properties of noise that concern the amplitude-time relationship are usually described by statistical means². (Refer to paragraph 2.3.)

Random-noise generators can be used to demonstrate some concepts of statistical theory. The equipment and methods for demonstrating various degrees of correlation and possible errors of random sampling are described by J. C. R. Licklider and E. Dzendolet, "Oscillographic Scatterplots Illustrating Various Degrees of Correlation", Science, January 30, 1948, Vol. 107, No. 2770, pp. 121-124.

4.7.5 NOISE AT HIGH FREQUENCIES. The noise generator can be used to modulate an r-f carrier when a noise signal is desired at a frequency above 5Mc. The Type 1000-P6 Crystal Diode Modulator⁸ is a suitable instrument for wide-band modulation, and the Type 1208-B VHF Unit Oscillators⁹ and the Type 1209-B UHF Unit Oscillators are suitable rf oscillators covering the range from 65 to 920 Mc.

Because of the two sidebands that result from the standard modulation techniques, the noise band can be made to extend over a 10-Mc range, 5 Mc on each side of the carrier. For some applications it may be desirable to use a suppressed-carrier or balanced-type modulator (see Terman, Radio Engineering Handbook, New York, McGraw-Hill Book Co., 1943, pp. 551-553). It is also possible to use a series of carriers and modulators to combine to give a much broader band of noise than 10 Mc.

Some signal generators and oscillators include modulating circuits, so that an external source such as the Type 1390-B Random-Noise Generator can be used to modulate the signal. Instruments of this type are the Types 1001-A, 1021-AU, and 1021-AV Standard Signal Generators. For these generators the modulation produced is limited to the audio range and to about 5 to 10 percent rms noise modulation, with peaks much higher. When a wider frequency band is desired, the Type 1000-P6 or some other external modulator should be used as described above.

⁸ Byers, W. F., "An Amplitude Modulator for Video Frequencies", General Radio Experimenter, March 1950, Vol. 24, No. 10, pp. 6-8.

⁹ E. Karplus, "V-H-F and U-H-F Unit Oscillators", General Radio Experimenter, May 1950, Vol. 24, No. 12, pp. 7-11.

TYPE 1390-B RANDOM-NOISE GENERATOR

4.7.6 VERY HIGH NOISE LEVELS. When noise levels even higher than those provided by the Type 1390-B Random-Noise Generator are desired, an amplifier should be used, such as the Type 1206-B Unit Amplifier. The Type 1233-A Power Amplifier is useful when a wide frequency range is desired.

4.7.7 INTERFERENCE TESTS. Since noise is a common form of interfering or disturbing signal or signal that limits the threshold of detectability, the noise generator can be used to check receivers, communication systems, and detection systems for susceptibility to interference. It can also be used as a training aid for operators who must communicate through interference.

4.7.8 OVER-ALL CALIBRATION TESTS. The noise generator can be used as an over-all calibration device because of the wide frequency range available at the output. This calibration signal can be particularly useful in audio systems that involve a recording technique, and its use can frequently simplify the calibration procedure when an analyzer forms part of the system.¹⁰

For example, when a magnetic tape recorder is used to record a signal to be measured on playback, reference signals must be recorded before and after the unknown signal is recorded. These reference signals permit one to fix levels and to determine response characteristics, which can vary from time to time depending on the condition of the tape and the machine. These reference signals are usually a series of tones at various points in the frequency range of interest. The noise generator, due to the broad frequency band, permits the use of a more versatile reference signal. Thus a useful set of reference signals would be a burst of noise of about one-half minute duration and a burst of a 400-cycle tone of about the same length. These two signals would permit the determination of frequency response, signal-to-noise ratio, harmonic distortion (at one level and one frequency), and flutter.

To determine the frequency response by use of a noise signal, perform the following operations:

1. Set the noise generator to the 20-kc range. Connect it to the input of the system under test, at such a level that the r-m-s input is at least 14 decibels below the sine-wave overload point.

2. Make a frequency spectrum analysis of the input noise signal and of the output noise signal from the device under test. The relative level of input and output as a function of frequency is then the frequency

response of the device under test, unless spurious signals are present in the output of the device.

3. Test for spurious signals by making an analysis of the output with no input signal applied.

When these measurements are made, the input and output must be analyzed by analyzers of the same effective bandwidth. The bandwidth of the analyzer should also be appreciably smaller than the bandwidth of the device under test. Furthermore, the ultimate attenuation of the analyzer should be much greater than variation in response that one expects to measure, so that it will not limit the observed response. Distortion and background noise in the device under test will also limit the range of variation in response that can be measured by this method, and it is therefore important to select the proper level for input signal.

4.7.9 ANALYSIS OF NOISE. In the course of measurements with a noise generator, it is often necessary to make a frequency spectrum analysis of noise. The Type 1900-A Wave Analyzer, the Types 1558-A and 1558-AP Octave-Band Noise Analyzers, and the Type 1564-A Sound and Vibration Analyzer are useful accessories for this analysis in the audio-frequency range. The results of noise analyses by these different analyzers cannot be compared directly; the results must be modified because of the different bandwidths. Refer to paragraph 2.5 for a discussion of the frequency spectrum of noise.

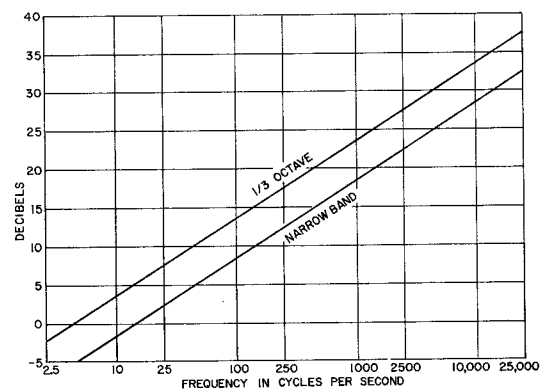

Figure 12. Decibels to Be Subtracted from Type 1564-A Reading to Obtain Spectral-Density Level.

The bandwidths of the Octave-Band Noise Analyzers increase in cycles directly with the mean frequency of the band. For that reason, a noise signal that is uniform in spectral-energy density over the frequency range will give higher-level readings for the higher-frequency bands than for the lower-frequency bands. The following table shows the values to be subtracted from the readings of the analyzer to obtain the spectral-density levels.

¹⁰S. S. Stevens, J. P. Egan, and G. A. Miller, "Methods of Measuring Speech Spectra", *Journal of the Acoustical Society of America*, Vol. 19, No. 5, September 1947, pp. 771-780.

GENERAL RADIO COMPANY

Type 1550-A Band	DB to be sub- tracted	Type 1558-A Band	DB to be sub- tracted	Type 1558-AP Band Center freq.	DB to be sub- tracted
20-75	18	18.75-37.5	13	31.5	13.5
75-150	19	37.5-75	16	63	16.5
150-300	22	75-150	19	125	19.5
300-600	25	150-350	22	250	22.5
600-1200	28	350-600	25	500	25.5
1200-2400	31	600-1200	28	1,000	28.5
2400-4800	34	1200-2400	31	2,000	31.5
4800-10kc	38	2400-4800	34	4,000	34.5
		4800-9600	37	8,000	37.5
		9600-19,200	40	16,000	40.5
		LP 7.5	18		

The effective bandwidth of the Type 1564-A Sound and Vibration Analyzer increases with increase in the frequency to which the analyzer is tuned. The graph in Figure 12 shows the value in decibels that must be subtracted from the reading of the analyzer to obtain the spectral-density level. This value is determined on the basis of initial calibration of the instrument by a sine-wave signal.

The corrections for spectral density level for the Type 1900-A Wave Analyzer are independent of the center frequency to which it is tuned but do depend on the bandwidth used. For the 3-cycle bandwidth subtract 3.7 db; 10-cycle, subtract 9 db; 50-cycle, subtract 15.9 db to obtain the spectral density level. (These correction numbers take into account the metering characteristic as well as the bandwidth.)

4.7.10 FREQUENCY RESPONSE MEASUREMENT. The noise generator can be used in place of the usual sine-wave oscillator for measuring the response of circuits and systems. In this application the selective characteristics of generator and detector are reversed from those ordinarily used in point-by-point measurements; the wide-band noise source and a selective detector replace the single-frequency source and wide-band detector. For speech and music circuits, this technique provides a much closer approximation to operating conditions than does the older system. This approach is particularly useful in testing recording systems.¹⁰ The usual sweeping sinusoidal tests are sometimes inconvenient because of the problem of determining the recorded frequency during playback. This

problem is eliminated by a recorded noise signal that is analyzed on playback.

Because of its broad frequency spectrum, noise is often used to avoid the marked resonance effects that can occur when vibrations in mechanical structures and acoustical systems are measured. The use of noise as a source in measuring the reverberation characteristics of rooms and the transmission characteristics of building structures results in a type of electrical averaging of the characteristics, provided a reasonably broad band is used. This averaging often simplifies the comparison of the characteristics of different structures.

The noise generator is useful in response measurements on loudspeaker systems in rooms.¹¹ The electrically averaged response can be used to determine the optimum characteristic for equalizing networks, to set the relative levels of woofer and tweeter units, and to adjust levels of multiple-speaker units installed in different locations in a large hall.

4.7.11 RESONANCE TESTS. Because of its broad frequency spectrum, noise can sometimes simplify the search for resonant conditions in a system.¹² The resonance produces a peak in the frequency spectrum, which can be observed in oscillographic displays.

4.7.12 OTHER USES. The noise generator can also be used in crosstalk measurements¹³, for masking crosstalk in multichannel communication systems¹⁴, to drive vibrators in component testing¹⁵, for noise factor comparison tests¹⁶, or distortion measurements¹⁷.

¹¹ L. L. Beranek, Acoustic Measurements, New York, John Wiley, 1949, pp. 665-668 and 697-702.

¹² Emory Cook, "White-Noise Testing Methods", Audio Engineering, Vol. 34, No. 3, March 1950, pp. 13-15.

¹³ J. P. Vasseur, "Les foyers hertziens a courants

porteurs devant les recommandations du C.C.I.F.", Annales de Radioelectricite, Vol. 9, No. 35, January 1954, pp. 47-82 and EIA Standard RS-252, "Base band Characteristics of the Microwave Radio and Multiplex Equipment," October, 1961.

TYPE 1390-B RANDOM-NOISE GENERATOR

- ¹⁴ A. J. Aikens and C. S. Thaeler, "Noise and Cross-talk on N1 Carrier Systems", Electrical Engineering, Vol. 72, No. 12, December 1953, pp. 1075-1080.
- ¹⁵ J. Robbins, "Standardized White Noise Tests", Electronic Industries & Tele-Tech, Vol 16, No. 2, February, 1957, pp. 68-69.

S. H. Crandall, ed., Random Vibration, Cambridge, Massachusetts, The Technology Press of MIT, 1958.

- ¹⁶ IRE "Standards on Electron Devices: Methods of Measuring Noise", Proceedings of the IRE, Vol. 41, No. 7, July 1953, pp. 891-896.

- ¹⁷ A. P. G. Peterson, "Intermodulation Distortion," 1957 IRE National Convention Record, Vol. 5, Part 7, March, 1957, pp 51-58.

J. S. Murray and J. M. Richards, "Non-linearity Distortion Measurements," Wireless World, Vol. 69, No. 4, April, 1963, pp 161-165.

Section 5

SERVICE AND MAINTENANCE

5.1 GENERAL. The two-year warranty given with every General Radio instrument attests the quality of materials and workmanship in our products. When difficulties do occur, our service engineers will assist in any way possible.

In case of difficulties that cannot be eliminated by the use of these service instructions, please write or phone our Service Department, giving full information of the trouble and of steps taken to remedy it. Be sure to mention the serial and type numbers of the instrument.

Before returning an instrument to General Radio for service, please write to our Service Department or nearest district office (see back cover), requesting a Returned Material Tag. Use of this tag will insure proper handling and identification. For instruments not covered by the warranty, a purchase order should be forwarded to avoid unnecessary delay.

5.2 ACCESS TO COMPONENTS. To remove the shield, loosen the two fluted locking screws on the back of the instrument. These will unlock on the first turn, but should be loosened the maximum amount before the shield is removed. Pull the shield straight back from the panel.

5.3 PRELIMINARY CHECKS. If the noise generator is inoperative, make the following checks before removing the case. Make sure that the ac supply is plugged into a live power line, that the power switch is turned to the POWER position, that the output control is turned up, that the time-delay relay is operative, and that the fuses are not open.

5.4 METER DOES NOT READ. Disconnect any load from the output terminals to insure that the load impedance is not too low to permit a meter reading. Place the output switch in the HIGH position.

5.5 TUBE REPLACEMENT. Since the vacuum tubes have a shorter life on the average than the other components used in the instrument, they should be tested if the instrument is still inoperative after the above checks have been made.

The Type 6D4 Gas Triode used as the noise source is aged and selected for uniformity of the noise spectrum and for good amplitude characteristics. If the tube has deteriorated and must be replaced, some selection among different tubes of this type may be necessary to find a satisfactory replacement.

5.6 HEATER VOLTAGE OF TYPE 6D4 GAS TUBE. The potentiometer at the rear of the chassis is for setting the heater voltage of the gas tube. Over certain ranges of heater voltage, some gas tubes will "sputter". The meter indication on the 20-kc range will often reveal this sputter. Under normal conditions, the meter reading fluctuates two or three percent. When sputtering occurs, the meter reading may fluctuate 10 percent or more. The sputtering is more easily detected by observation of the noise pattern on an oscilloscope or by ear with a good pair of earphones. The heater voltage should be set so that this sputtering does not occur. Some selection among tubes of this type may be necessary to find a tube that is free from sputtering.

5.7 VOLTAGE MEASUREMENTS. The following tables give test voltages for aid in troubleshooting:

T1 TRANSFORMER MEASUREMENTS

Between Terminals	AC Volts
10 and 11	120
5 and 6	17
6 and 7	17
8 and 9	6.3

GENERAL RADIO COMPANY

TABLE OF VOLTAGES

TUBE	PIN	VOLTS	TUBE	PIN	VOLTS
V1 (3-4)	2	13.4	V3 (6AQ5) (cont.)	6	150 (A)
	7	6.3			150 (B)
V2 (6D4)	3	6.3	V4 (6AQ5)	1	0
	4	0		2	13
	7	16.0		3 to 4	6.3 ac
V3 (6AQ5)	1	0	V5 (115NO30T)	5	165
	2	5.5		6	245
	3	20		4	120 ac*
	4	13.4	9	120 ac*	
	5	230 (A) 215 (B) 45 (C)			

NOTES

Voltages are measured with a 20,000-ohms-per-volt voltmeter and are dc with respect to ground unless otherwise stated.

(A) S3 = 5 Mc

(B) S3 = 500 kc

(C) S3 = 20 kc

* Voltages are measured with a 1000 Ω /volt rectifier meter, and are with respect to terminal 11 on transformer T1.

TYPE 1390-B RANDOM-NOISE GENERATOR

PARTS LIST

PART NO. (NOTE A)									
RESISTORS (NOTE B)					CAPACITORS (NOTE C)				
R1	470	± 5%	5 w	REPO-22	C1A	25	}	200 dcwv	COE-51
R2	330	± 5%	5 w	REPO-22	C1B	25			
R3	220	± 5%	5 w	REPO-22	C2A	50	}	450 dcwv	COE-10
R4	5.1 k	±10%	1 w	REC-30BF	C2B	25			
R5	10 k	±10%	2 w	REC-41BF	C2C	25	}	450 dcwv	COE-10
R6	10 k	±10%	2 w	REC-41BF	C3A	50			
R7	56	± 5%	1/2 w	REC-20BF	C3B	25	}	25 dcwv	COE-39
R8	250	±10%		POSW-3	C3C	25			
R9	150 k	± 5%	1/2 w	REC-20BF	C4A	800	}	25 dcwv	COE-39
R10	16 k	± 5%	1/2 w	REC-20BF	C4B	400			
R11	330	± 5%	1/2 w	REC-20BF	C4C	400	}	COC-1	COP-19
R12	100	± 5%	5 w	REPO-22	C5	1.0 μμf ±10%			
R13	2.2 k	± 5%	1/2 w	REC-20BF	C6	0.47 ±10%	600 dcwv		
R14	56	± 5%	1/2 w	REC-20BF	C7	15	300 dcwv		
R15	56 k	± 5%	1/2 w	REC-20BF	C8A	50	}	450 dcwv	COE-10
R16	330	± 5%	1/2 w	REC-20BF	C8B	25			
R17	68	± 5%	1/2 w	REC-20BF	C8C	25	}	COM-20B	COM-20B
R18	22 k	± 5%	1/2 w	REC-20BF	C9	680 μμf ±10%			
R19	2.2 k	± 5%	5 w	REPO-22	C10	470 μμf ±10%			
R20	470 k	± 5%	1/2 w	REC-20BF	C11	0.0022 ±10%	600 dcwv		
R21	56	± 5%	1/2 w	REC-20BF	C12	300 μμf ±10%			
R22	180	± 5%	1/2 w	REC-20BF	C13	0.01 ±20%	500 dcwv		
R23	150	± 5%	1/2 w	REC-20BF	C14	5-20 μμf ±10%			
R24	15 k	± 5%	5 w	REPO-43	C15	0.33 ±10%	600 dcwv		
R25	1 k	± 5%	1 w	REC-30BF	C16A	1500	}	10 dcwv	COE-9
R26	1 k	± 5%	1/2 w	REC-20BF	C16B	750			
R27	220	± 5%	1/2 w	REC-20BF	C16C	750	}	500 dcwv	COC-62
R28	5.1 k	±10%	1 w	REC-30BF	C17	0.01 ±20%			
R32	1.5	± 5%	5 w	REPO-22	C18	50 μμf ±10%			
R33	2.5 k	±10%		POSC-7	C19	50 μμf ±10%			
R34	15	±10%	2 w	REW-3C	C20	50 μμf ±10%			
R35	2 k	± 1%	1/4 w	REF-65	C21	470 μμf ±10%			
R36	2 k	± 1%	1/4 w	REF-65					
R37	2 k	± 1%	1/4 w	REF-65					
R38	2 k	± 1%	1/4 w	REF-65					
R39	246.9	±0.25%		700-352	C100	6.8 μμf ± 5%			COC-1
R40	246.9	±0.25%		700-352	C101	100	3 dcwv		COE-46
R41	246.9	±0.25%		700-352	C102	100	3 dcwv		COE-46
R42	222.2	±0.25%		700-351					
					DIODES				
					D100	1N995	D101	1N995	
					FUSES				
R100	2.7 k	± 5%	1/2 w	REC-20BF	F1	(for 115 v) 0.6 amp Slo-Blo			
R101	4.3 k	± 5%	1/2 w	REC-20BF		3AG			FUF-1
R102	5.1 k	± 5%	1/2 w	REC-20BF	F1	(for 230 v) 0.3 amp Slo-Blo			
R103	5 k	±20%		POSC-22		3AG			FUF-1

Continued

GENERAL RADIO COMPANY

PARTS LIST (Continued)

FUSES (Continued)			RECTIFIERS			
F2	(for 115 v) 0.6 amp Slo-Blo 3AG	FUF-1	RX1	1N1695	RX3	1N1692
F2	(for 230 v) 0.3 amp Slo-Blo 3AG	FUF-1	RX2	1N1695	RX4	1N1692
INDUCTORS			SWITCHES			
L1	22 μ h \pm 10%	CHM-1	S1	SWT-333NP	S3	SWRW-181
L2	50 mh	379-35	S2	SWRW-180	S4	SWRW-182
L3	0.5 mh	CHA-597A	TRANSFORMER			
METER			T1	485-497		
M1	0-200 μ a 680 Ω	MEDS-92	TUBES			
PILOT LAMP			V1	3-4	V4	6AQ5
P1	Mazda Type 44	2LAP-939	V2	6D4	V5	115N030T
			V3	6AQ5		

NOTES:

(A) Type designations for resistors and capacitors are as follows:

- | | |
|----------------------------------|-----------------------------------|
| COC - Capacitor, ceramic | POSC - Potentiometer, composition |
| COE - Capacitor, electrolytic | POSW - Potentiometer, wire-wound |
| COL - Capacitor, oil-impregnated | REC - Resistor, composition |
| COM - Capacitor, mica | REF - Resistor, film |
| COP - Capacitor, plastic | REPO - Resistor, power |
| COT - Capacitor, trimmer | |

(B) All resistances are in ohms unless otherwise designated by k (kilohms).

(C) All capacitances are in microfarads unless otherwise designated by $\mu\mu$ f (micromicrofarads).

TYPE 1390-B RANDOM-NOISE GENERATOR

Rotary switch sections are shown as viewed from the panel end of the shaft. The first digit of the contact number refers to the section. The section nearest the panel is 1, the next section back is 2, etc. The next two digits refer to the contact. Contact 01 is the first position clockwise from a strut screw (usually the screw above the locating key), and the other contacts are numbered sequentially (02, 03, 04, etc.), proceeding clockwise around the section. A suffix F or R indicates that the contact is on the front or rear of the section, respectively.

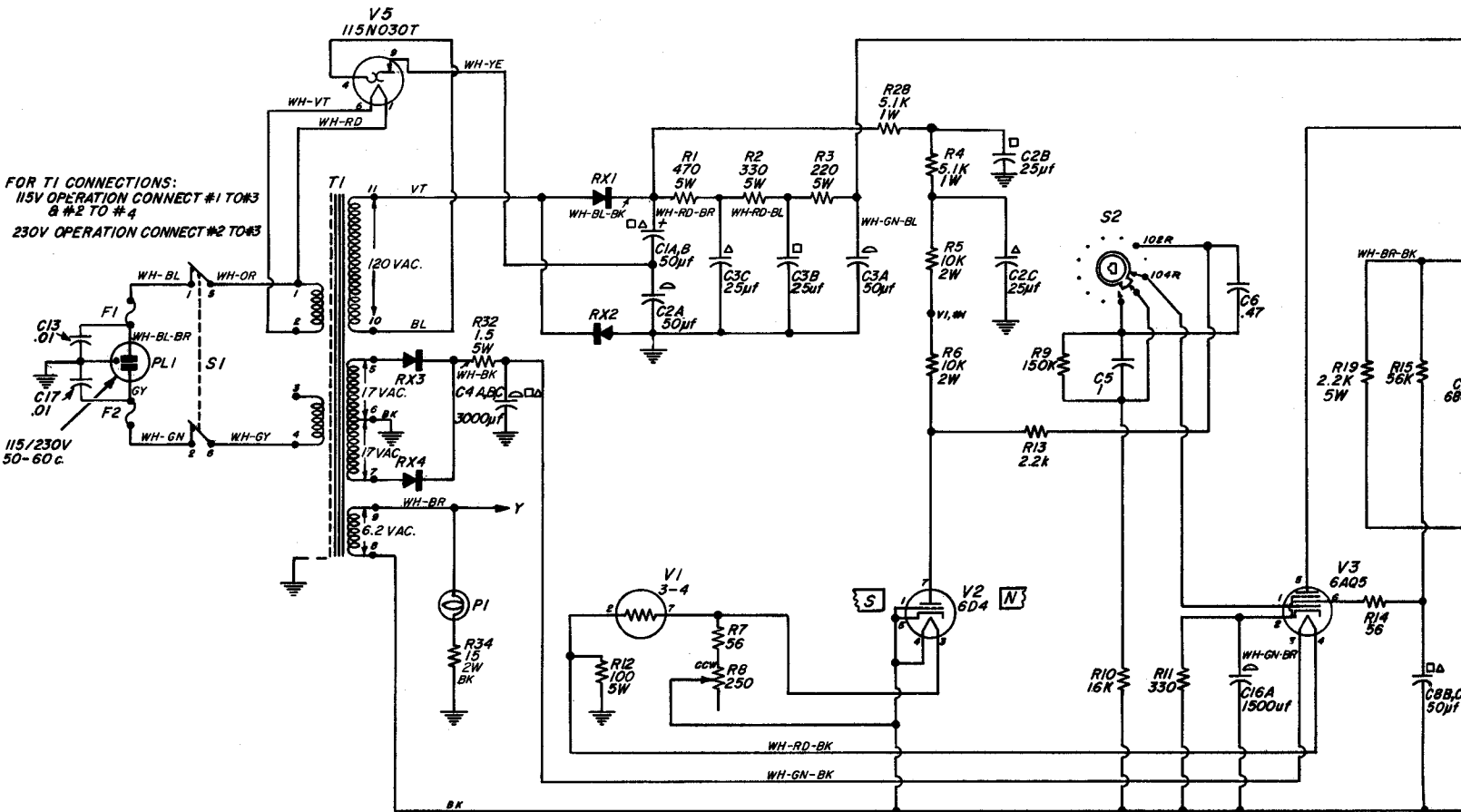
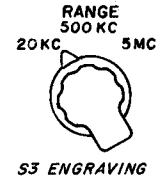
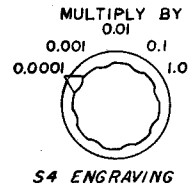

Figure 12. Schematic W

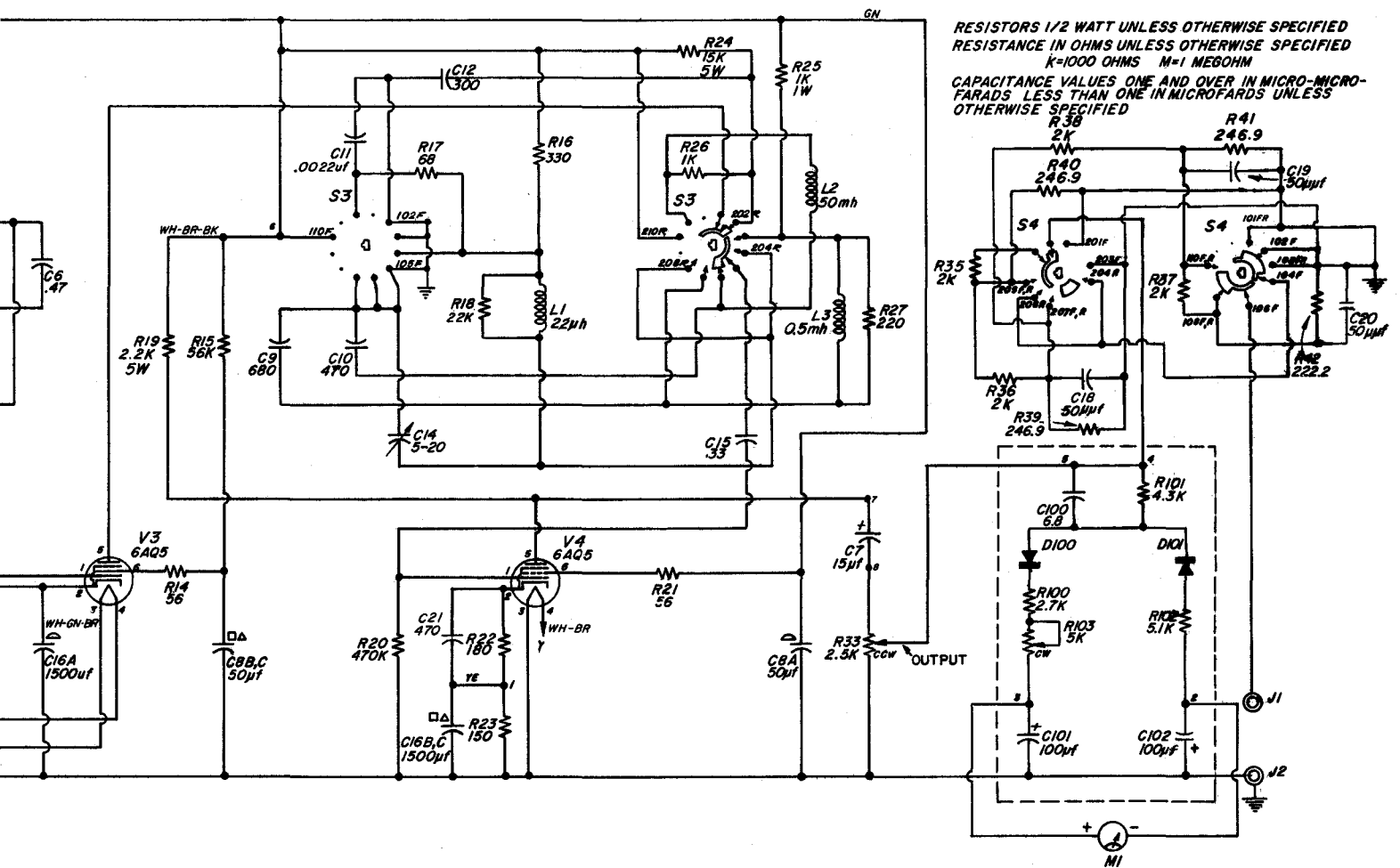
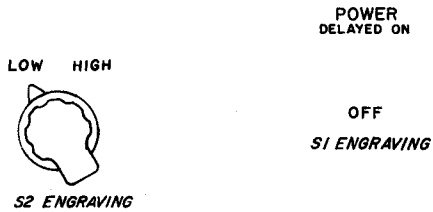

Figure 12. Schematic Wiring Diagram.

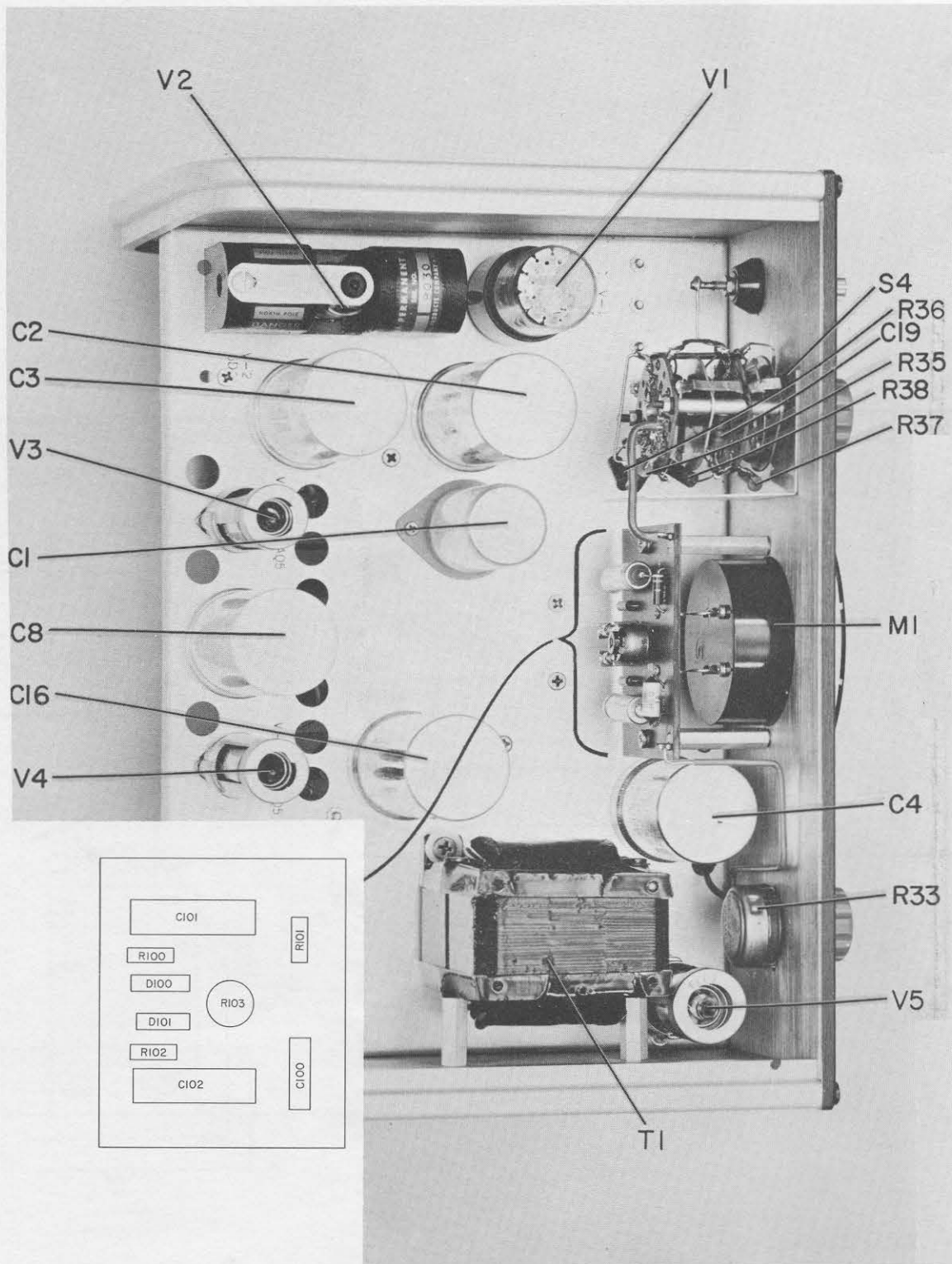

Figure 10. Top Interior View.

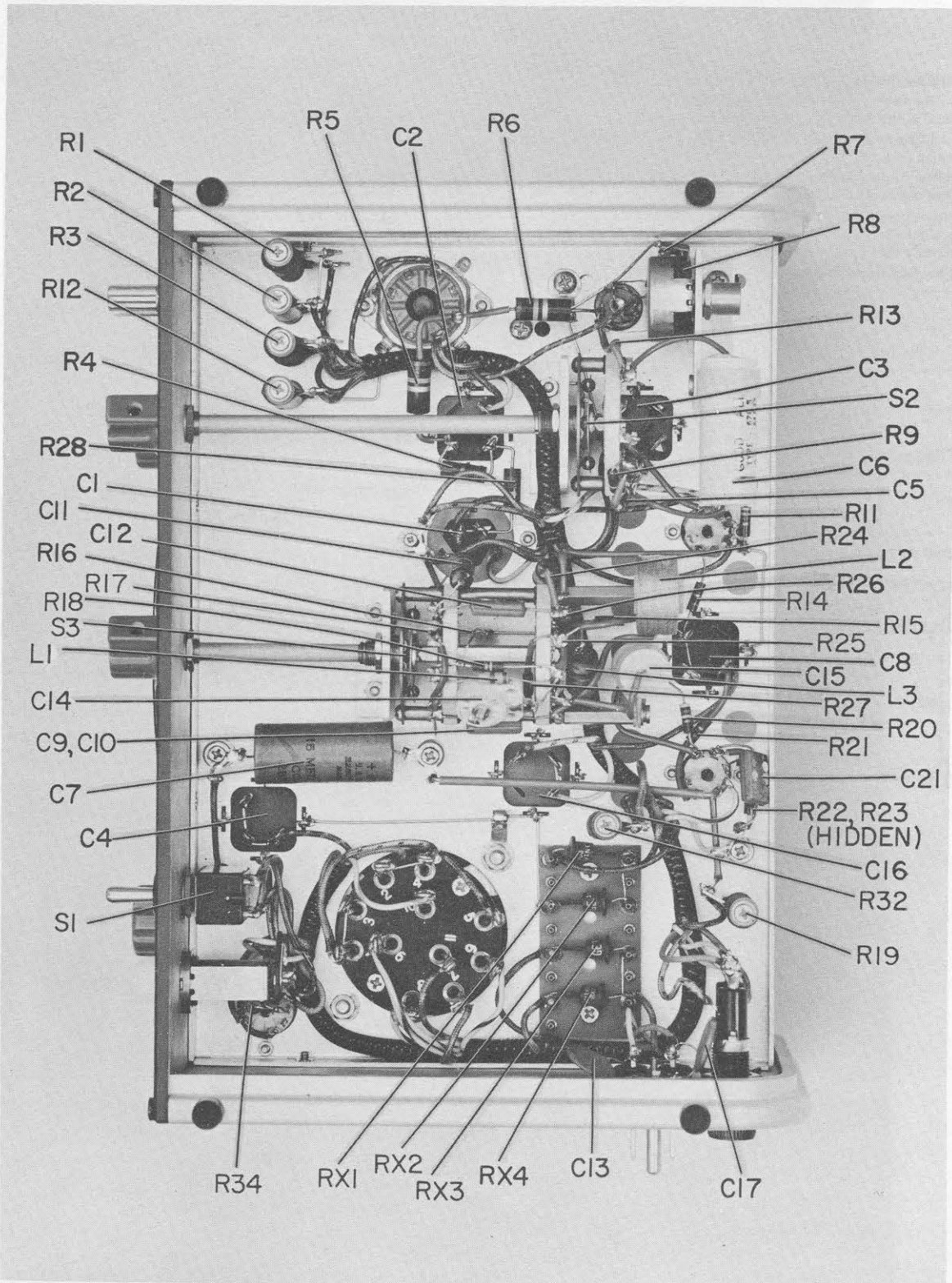

Figure 11. Bottom Interior View.

GENERAL RADIO COMPANY

WEST CONCORD, MASSACHUSETTS 01781

617 369-4400

617 646-7400

SALES ENGINEERING OFFICES

NEW ENGLAND*

22 Baker Avenue
West Concord, Massachusetts 01781
Telephone 617 646-0550

METROPOLITAN NEW YORK*

Broad Avenue at Linden
Ridgefield, New Jersey 07657
Telephone N.Y. 212 964-2722
N.J. 201 943-3140

SYRACUSE

Pickard Building
East Molloy Road
Syracuse, New York 13211
Telephone 315 454-9323

PHILADELPHIA

Fort Washington Industrial Park
Fort Washington, Pennsylvania 19034
Telephone 215 646-8030

WASHINGTON* and BALTIMORE

11420 Rockville Pike
Rockville, Maryland 20852
Telephone 301 946-1600

ORLANDO

113 East Colonial Drive
Orlando, Florida 32801
Telephone 305 425-4671

CHICAGO*

6605 West North Avenue
Oak Park, Illinois 60302
Telephone 312 848-9400

CLEVELAND

5579 Pearl Road
Cleveland, Ohio 44129
Telephone 216 886-0150

LOS ANGELES*

1000 North Seward Street
Los Angeles, California 90038
Telephone 213 469-6201

SAN FRANCISCO

1186 Los Altos Avenue
Los Altos, California 94022
Telephone 415 948-8233

DALLAS*

2600 Stemmons Freeway, Suite 210
Dallas, Texas 75207
Telephone 214 637-2240

TORONTO*

99 Floral Parkway
Toronto 15, Ontario, Canada
Telephone 416 247-2171

MONTREAL

1255 Laird Boulevard
Town of Mount Royal, Quebec, Canada
Telephone 514 737-3673

* Repair services are available at these offices.

General Radio Company (Overseas), 8008 Zurich, Switzerland
General Radio Company (U.K.) Limited, Bourne End, Buckinghamshire, England
Representatives in Principal Overseas Countries