



Hewlett-Packard has a complete line of laboratory quality pulse generators to meet your specific pulse requirements. A wide selection of non plug-in pulse generators are available to meet specific testing requirements at lowest possible cost. Also available are versatile plug-in building block systems that let you custom design a pulse testing system for optimum flexibility and performance at minimum cost. With a plug-in system you can select plug-ins to fit a particular test requirement, changing only those pulse parameters needed.

Digital formatting of pulses is available in either a dedicated pulse generator or as a basic building block in the plug-in system. Whatever your pulse requirement - high power, fast rise time, general purpose, or digital formatting, Hewlett-Packard has a solution.

1900 PULSE GENERATOR SYSTEM PLUG-INS*

	Rate		Delay		Digital		Output Pulse Shaping				
	1905A	1906A	1908A	1909A	1925A	1930A	1915A	1916A	1917A	1920A	1921A
Max Rep Rate (MHz)	25	125	25	125	50	40	25	100	25	25	125
Output V into 50 Ω	>3	>3	>3	>3	>2	>2	±50	±5V, ea output	±10	±5	+5
Transition Times	<5 ns	<3 ns	<5 ns		<4 ns	<4 ns	7 ns-1 ms	2.5ns-250 μs	7 ns-500 μs	<350 ps/ <400 ps	<2 ns
Width	<10 ns	<5 ns	<10 ns	<4 ns	RZ/ NRZ	RZ/ NRZ	15 ns-40 ms	5 ns-1 ms	15 ns-40 ms	0-10 μs	4 ns-1 ms
Offset (V into 50 Ω)							±1.5	±2.5	±2.5	±2	±5
Output Complement					●			●			●
Delay Control			Var	Var							
Advance/Double Pulse			●	Double Pulse							
Gated Output	●	●									
Ext Trigger Input	●	●			●						
Digital Formatting (Word Generation)					2-16 bits						
RZ/NRZ Format					●	●					
NRZ Shaping							●		●		●
Pseudorandom Binary Sequence					●	●					
Bit Error Detection						●					
Multiphase Output											
Programmable**	Opt	Opt	Opt	Opt	Std	Std	Opt		Opt	Opt	Opt

*Mainframes are required for plug-in operation. The two available are: Model 1900A for high power (1915A plug-in) pulse testing and digital systems. Model 1901A for general purpose pulse testing and digital systems.

**Programming requires Option 001 mainframes. Two versions are available: Option 001 plug-ins, for semi-automatic operation and Option 005 plug-ins to interface with computer controlled 6940A multiprogrammer.



PULSE AND WORD GENERATORS

	Pulse Generators												Word Generators	
	214A	8002A	8004A	8005B	8007B	8008A	8010A	8011A	8012B	8013B	8015A	8082A	8006A	8016A
Max Rep Rate (MHz)	1	10	10	20	100	200	10	20	50	50	50	250	10	50
Output V into 50Ω	±100	±5	±5	±5/±10	±5	±4/ECL	±5/±10	±16	±10	±10	±16	±5/ECL	+2.5/-5	ECL/T ² L
Simultaneous Output				±, ± T ² L		±, ± Compl	±, ±			+, -	±, ±	±, ± Compl	±, ±	8
Transition Times	<15 ns	10 ns to 2 s	<1.5 ns	<10 ns to 2 s	<2 ns to 250 μs	<1.2 ns	<10 ns to 1 s	<10 ns	5 ns to 0.5 s	<3.5 ns	<6 ns to 0.5 s	<1 ns to 0.5 ms	10 ns	2 ns/ 2.5 ns
Width	50 ns to 10 ms	30 ns to 3 s	0 to 1 ms	25 ns to 3 s	5 ns to 50 ms	2.5 ns to 50 ns	20 ns to 1 s	25 ns to 100 ms	10 ns to 1 s	10 ns to 1 s	10 ns to 1 s	2 ns to 0.5 ms		10 ns to 1 μs
Offset (V into 50Ω)			±2	±2	±4 Symm	±2	±2	Symm	±2.5 Symm	-5 to +1, Comp	±8	±2		
Square Wave Mode				●			●	●	●	●	●	●		
Delay Control	250 ns to 10 ms		125 ns to 1 ms	100 ns to 3 s	30 ns to 50 ms	30 ns to 50 ms	80 ns to 1 s		35 ns to 1 s	35 ns to 1 s	45 ns to 1 s	2 ns to 0.5 ms		0 to 1 μs
Double Pulse	●		●	●	●	●	●		●	●	●	●		
Gated Output	●	●	●	●	●	●	●		●	●	●	●	●	●
Ext Trigger	●	●	●	●	●	●	●		●	●	●	●	●	●
Digital Formatting (Word Generation)													two 16 bit/ one 32 bit	eight 32 bit
RZ/NRZ Formats													●	●
Pseudorandom Binary Sequence													●	
Remote Control											Optional		Std	Optional
Pulse Burst								Optional			Optional			
Selectable Source Imped.		●		●				●	●	●	●		●	●
Normal/Complement				●	●	●		●	●	●	●	●	●	●

LOGIC FAMILY APPLICATION CHART

	MECL III	ECL	S/TTL	TTL	DTL/RTL	CMOS	MOS	HTL
LOGIC TEST SIGNALS								
EDGE SPEED	1.5 ns	2.0 ns	2.5 ns	5 ns	5 ns	≤10 ns	≤10 ns	>10 ns
MAX CLOCK	250 MHz	100 MHz	30 MHz	10 MHz	10 MHz	<10 MHz	<10 MHz	1 MHz
PULSE GENERATORS								
214A High Power 100 V 1 MHz 15 ns fixed								
8002A 10 MHz ±5 V 10 ns var								
8004A 10 MHz ±5 V 1.5 ns fixed								
8005B 20 MHz + & -10 V 10 ns var								
8007B 100 MHz ±5 V 2 ns var								
8008A 200 MHz ±4 V 1.2 ns fixed								
8010A 10 MHz indep 5 V outputs 10 ns var								
8011A 20 MHz ±16 V 10 ns fixed								
8012B 50 MHz ±10 V 5 ns var								
8013B 50 MHz + & -10 V 3.5 ns fixed								
8015A 50 MHz + & -16 V 6 ns var								
8082A 250 MHz ±5 V 1 ns var								
1915A 25 MHz ±50 V 7 ns var								
1916A 100 MHz ±5 V 2.5 ns var								
1917A 25 MHz ±10 V 7 ns var								
1920A 25 MHz ±5 V 350 ps fixed								
1921A 25 MHz +5 V 2 ns fixed								
WORD GENERATORS								
8006A 10 MHz 2 ch 16 bit 5 V								
8016A 50 MHz 8 ch 32 bit TTL/ECL								

LOGIC APPLICATIONS

The vast majority of Hewlett-Packard pulse generators in use today are being used for digital circuit testing. The test signals vary with the type of logic being used. The voltage levels for each logic family are as shown in the figure below.

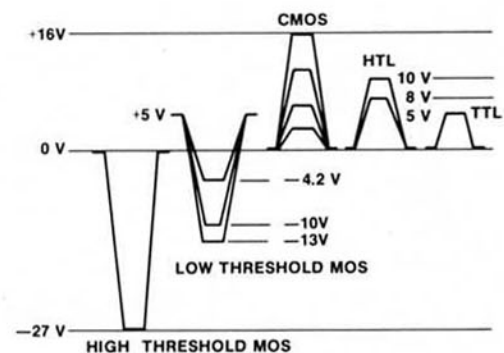

250, 200, 100 MHz pulse generators

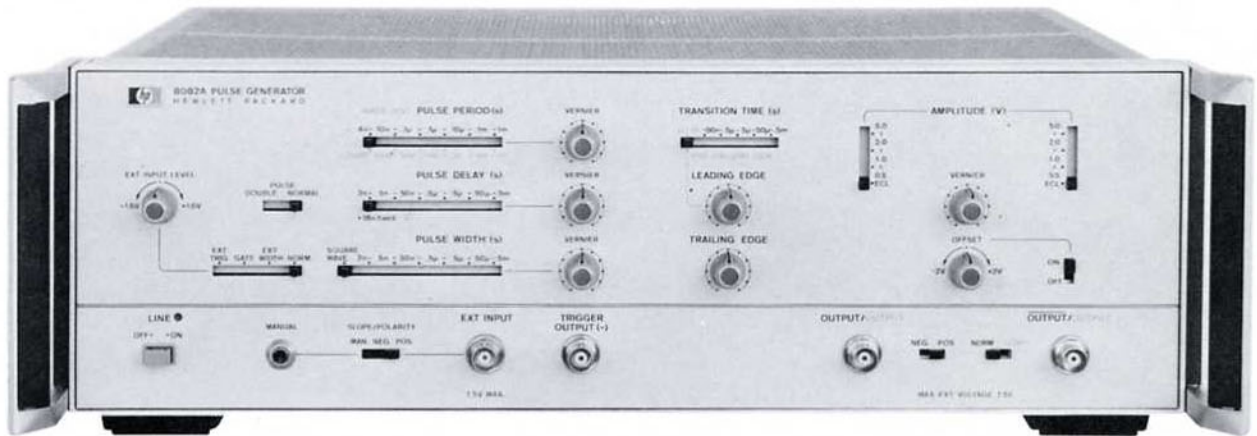

Model 8082A pulse generator

- 1 kHz to 250 MHz
- <1 ns to 0.5 ms transition times
- Simultaneous ± 5 V outputs (Norm/Compl)
- ECL Levels
- Low VSWR 50 Ω source impedance



Model 8008A pulse generator

- 10 Hz to 200 MHz
- ≤ 1.2 ns transition time
- Optional transition time converter

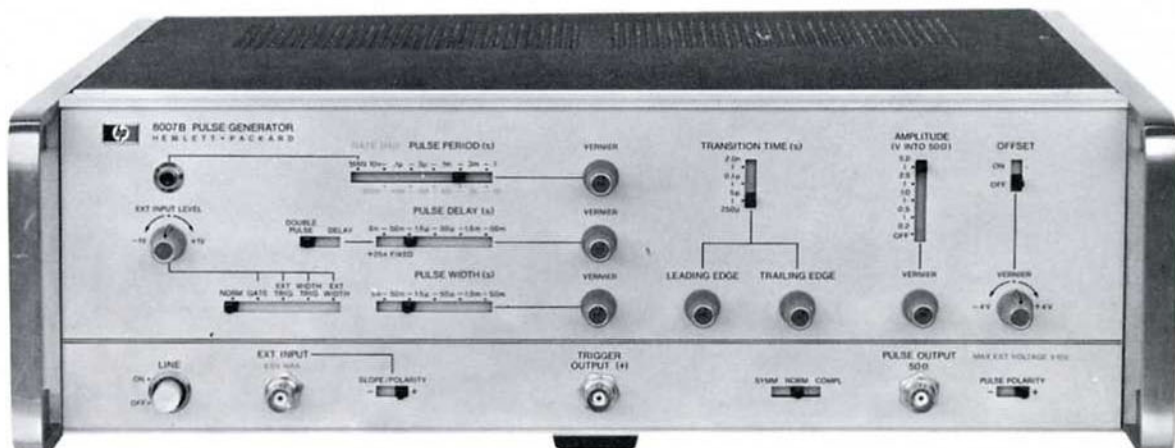

Model 8007B pulse generator

- 10 Hz to 100 MHz
- 2 ns to 250 μ s transition times
- Highly linear slopes
- ± 5 V output

50 MHz pulse generators



Model 8015A pulse generator (with pulse burst option)

- 1 Hz to 50 MHz
- 6 ns to 0.5 s transition times
- ± 16 V into 50 Ω
- Unique level controls
- Dual channel (optional single channel)
- Pulse burst option

Pulse Burst Option

The 8015A and 8011A pulse generator offer the convenient pulse burst option. This option is ideally suited for testing serial operated devices such as shift registers, counters, and MOS memories. With the burst option, the number of pulses is selected along with the other desired pulse parameters and the device is checked at operational speeds.



Model 8012B pulse generator

- 1 Hz to 50 MHz
- 5 ns to 0.5 s transition times
- 10 V into 50 Ω
- Double pulse, square wave mode



Model 8013B pulse generator

- 1 Hz to 50 MHz
- 3.5 ns transition times
- Simultaneous ± 10 V into 50 Ω
- Double pulse, square wave mode

20 MHz pulse generators



Model 8005B pulse generator

- 0.3 Hz to 20 MHz
- 10 ns to 2 s transition times

- Simultaneous ± 10 V into 50 Ω
- Separate TTL output



Model 8011A pulse generator

- 0.1 Hz to 20 MHz
- ± 16 V into 50 Ω
- Pulse burst option

Pulse Burst Option

This option is available with models 8015A and 8011A pulse generators. With the pulse burst option you can generate precisely any number of pulses from 1 to 9999, independent of pulse rate. The number of pulses required is set on thumbwheel switches. All other pulse parameters are set on the front panel as normal. Additional single pulses can be added manually.

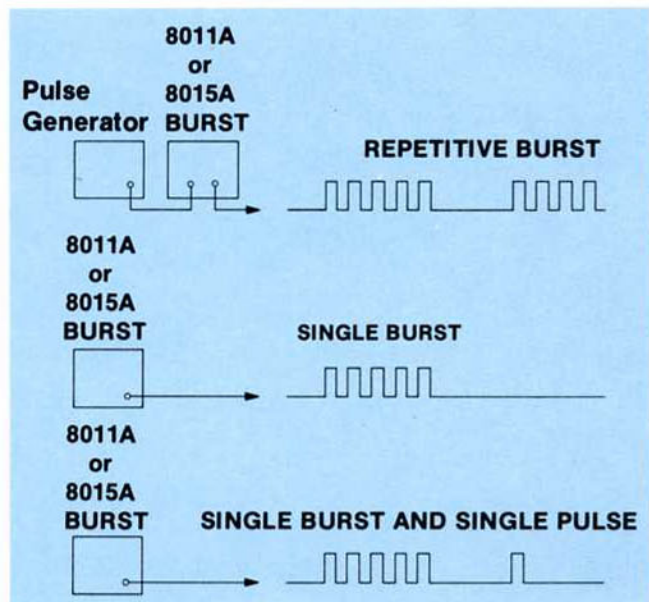

10 MHz pulse generators

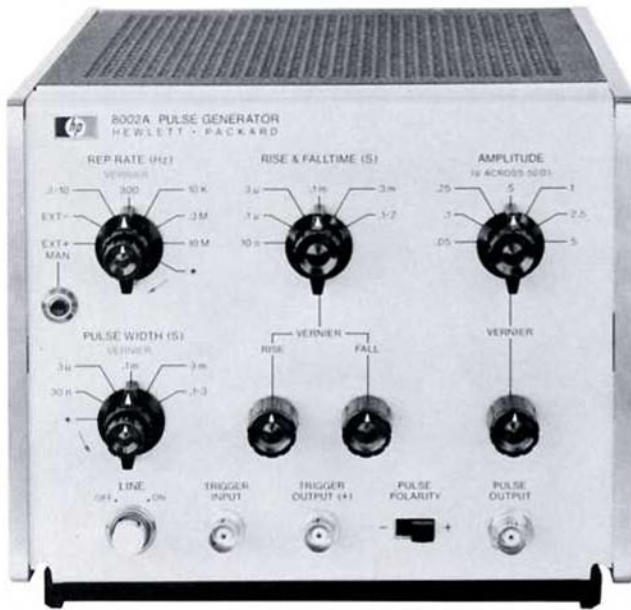

Model 8002A pulse generator

- 0.3 Hz to 10 MHz
- 10 ns to 2 s transition times
- ± 5 V (± 10 V max) output
- Source impedance selectable

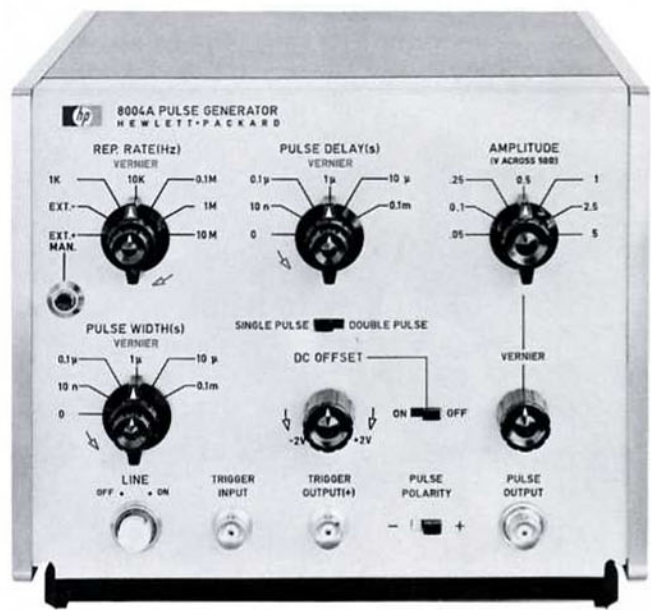

Model 8004A pulse generator

- 100 Hz to 10 MHz
- < 1.5 ns transition time
- ± 5 V output



Model 8010A pulse generator

- 1 Hz to 10 MHz
- 10 ns to 1 s transition times



- Two separate pulse generators in one unit with common rate control

high amplitude pulse generators

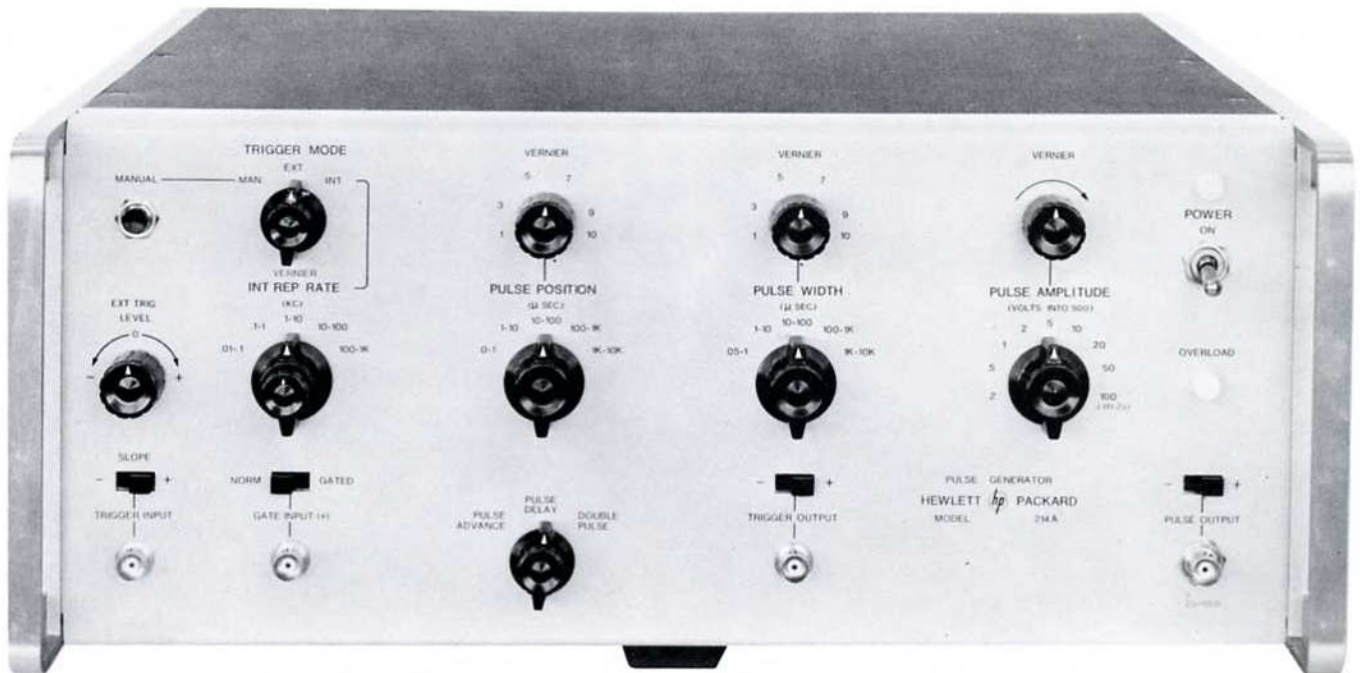

Model 214A pulse generator

- 10 Hz to 1 MHz
- <15 ns transition time
- ± 100 V output
- 200 watts

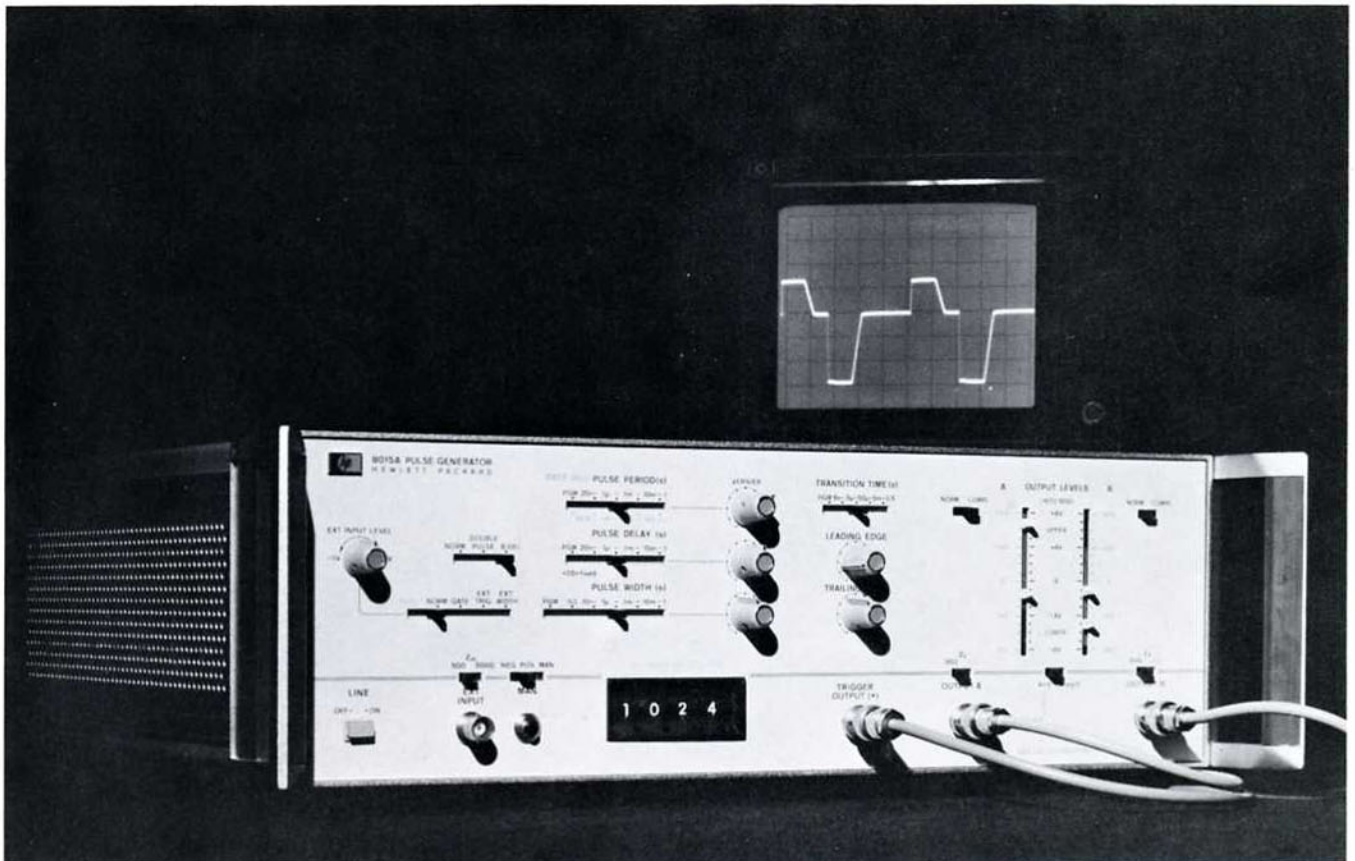

word generators

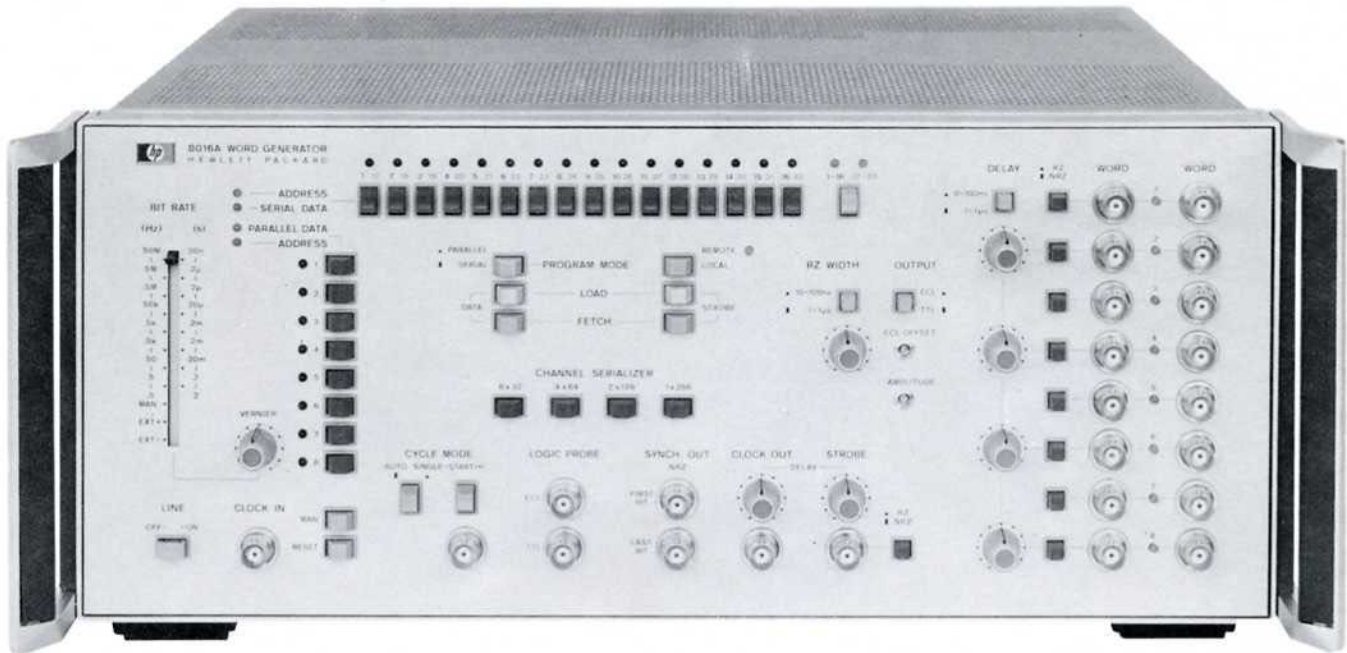

Model 8016A pulse generator

- 0.5 Hz to 50 MHz
- 8 channels
- Strobe output for 9th channel or floating trigger
- 32 bit words
- ECL/TTL compatible
- Optional programming
- Channel Serializer
 - 4 X 64 bit
 - 2 X 128 bit
 - 1 X 256 bit
- 4 channel variable delay
- Variable RZ width



Model 8006A pulse generator

- 10 Hz to 10 MHz
- Two 16 bit or one 32 bit word
- Pseudorandom binary sequence

1900 plug-in pulse generator system

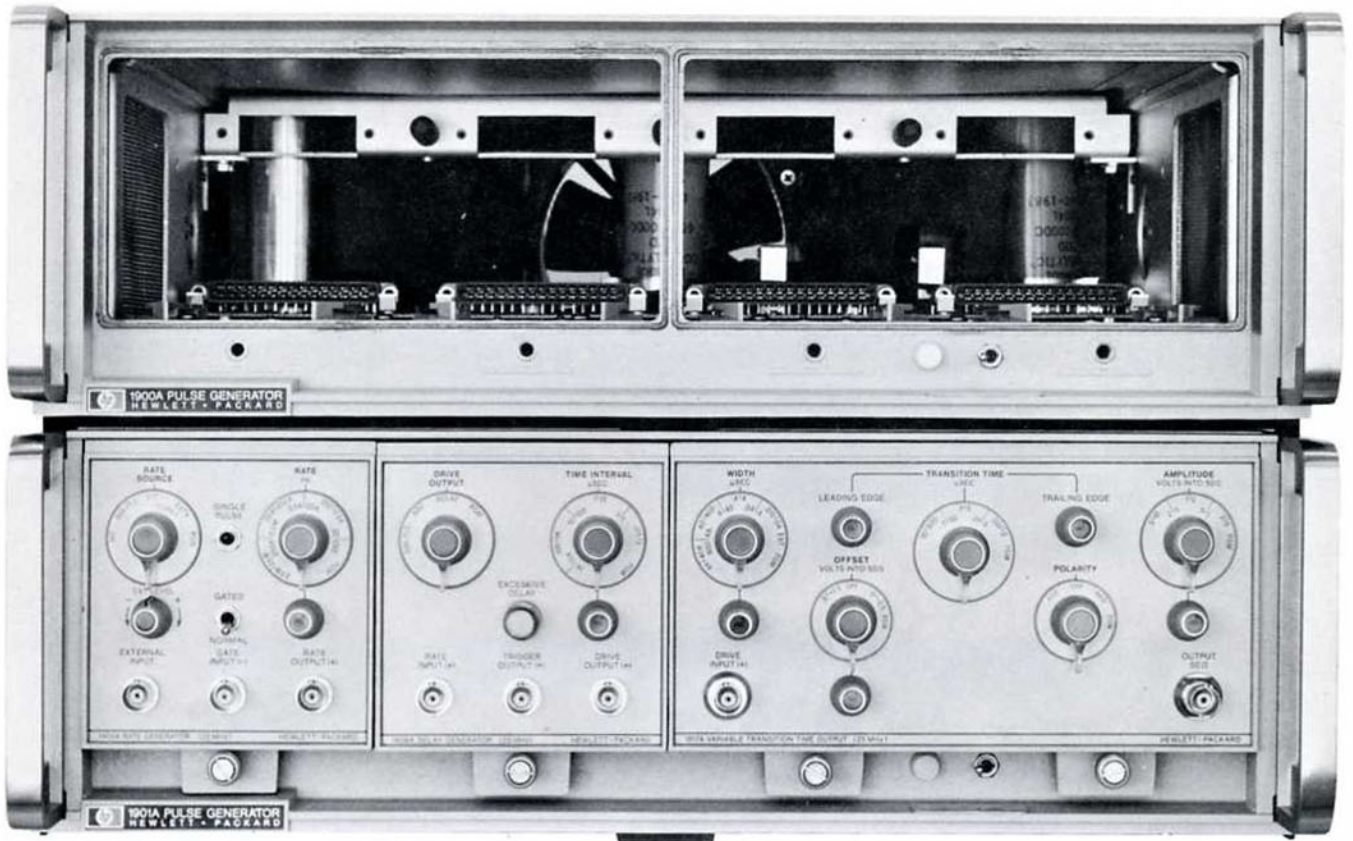

Models 1900A and 1901A mainframes accept many combinations of plug-ins to provide economical pulse generator systems tailored to fit exact requirements, from laboratory use to fully automated production test systems. Model 1900A contains power supplies for all 1900 series plug-ins including the high power (1 ampere into 50 ohms) 1915A output plug-in. Model 1901A contains power supplies for all 1900 series plug-ins except the 1915A. Both mainframes offer optional programming and contain EMI and RFI shielding to reduce interference in system applications.

1900 PULSE GENERATOR SYSTEM			
SYSTEM CLOCK (Rate)	INFORMATION (Timing)	INTERFACE (Output)	MAX REP RATE
1900A Mainframe		1915A* 50 V/7 ns, var 1 output	25 MHz
1901A Mainframe		1917A* 10 V/7 ns, var 1 output	
1905A* 25 Hz - 25 MHz	1908A* continuously var, delay 15 ns - 10 ms	1920A* 5 V/350 ps, fxd 1 output	40 MHz
	1930A** PRBS, coding, error rate		50 MHz
	1925A** 1 to 16 bit word/PRBS		100 MHz
1906A* 10 Hz - 125 MHz	1909A* continuously var, delay 16 ns - 1 ms	1916A 5 V/2.5 ns, var 2 outputs 1921A* +5 V/2 ns, fxd 1 output	125 MHz

* Optionally programmable

** Programming standard

Programming requires an Option 001 mainframe

1900 system output plug-ins

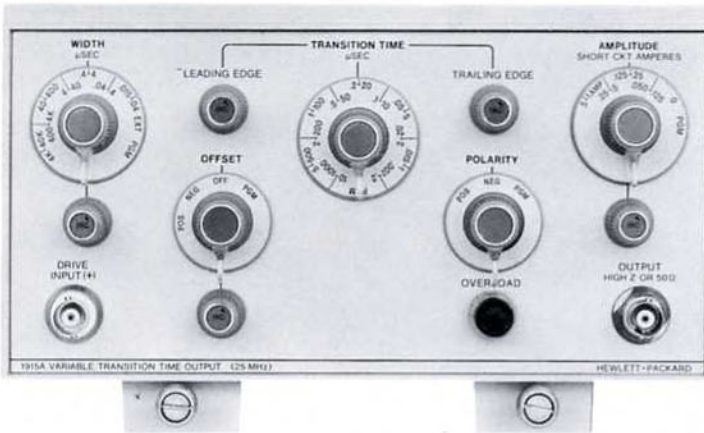

Model 1915A

variable transition time output

- 0 to 25 MHz repetition rate
- 7 ns to 500 μ s transition time
- 1 amp into 50 Ω
- Optional programming



Model 1916A

variable transition time output

- 0 to 100 MHz repetition rate
- 2.5 ns to 250 μ s transition times
- Two 5 V outputs

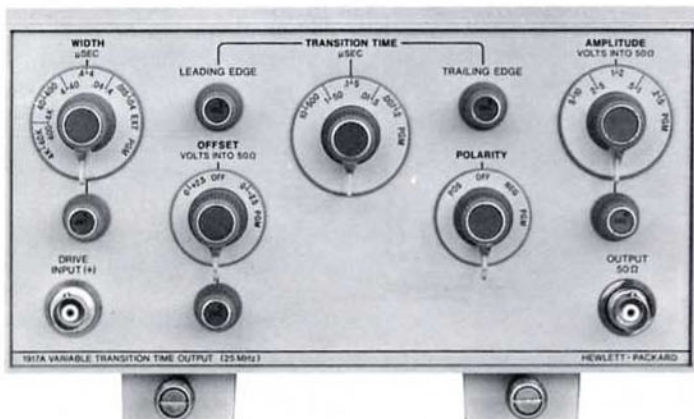

Model 1917A

variable transition time output

- 0 to 25 MHz repetition rate
- 7 ns to 500 μ s transition time
- 14 V across 50 Ω
- Source impedance selectable
- Optional programming

1900 system output and rate plug-ins

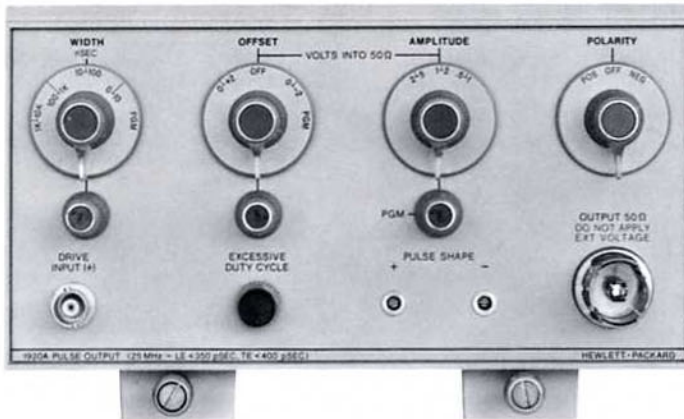

Model 1920A

350 ps rise time output

- 0 to 25 MHz repetition rate
- <350 ps rise time
- 0.5 to 5 V output
- Optional programming

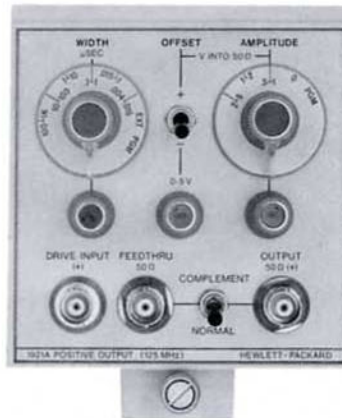

Model 1921A positive output

- 0 to 125 MHz repetition rate
- <2 ns fixed transition times
- Variable amplitude to +5 V
- Variable ± 5 V offset
- Feedthru pulse adding
- Optional programming



Model 1905A rate generator

- 0 to 25 MHz repetition rate
- Synchronous gating
- External triggering
- Optional programming

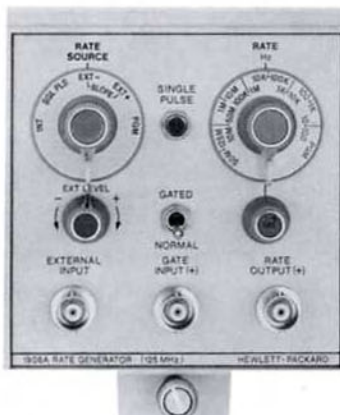

Model 1906A rate generator

- 0 to 125 MHz repetition rate
- Synchronous gating
- External triggering
- Optional programming

1900 system timing plug-ins



Model 1908A delay generator

- 0 to 25 MHz repetition rate
- Advance or delay from 15 ns to 10 ms
- Double pulse
- Optional programming

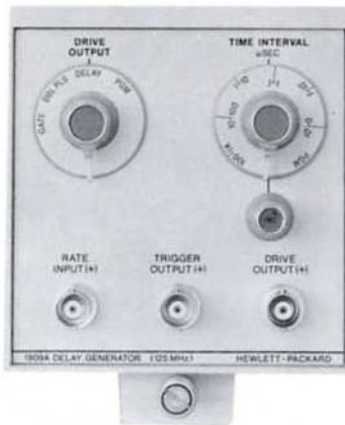

Model 1909A delay/gate generator

- 0 to 125 MHz repetition rate
- 0 to 1 ms delay
- Double pulse and gate pulse
- Optional programming



Model 1925A word generator

- 0 to 50 MHz clock
- 2 to 16 bit words
- RZ or NRZ formats
- Built-in programming
- Pseudorandom bit sequence

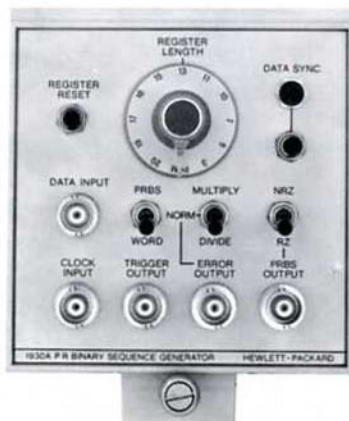

Model 1930A pseudorandom binary sequence generator

- >40 MHz repetition rate
- Random signal simulation
- Bit error detection
- Coding and encoding
- Built-in programming

1900/6940A digital programming

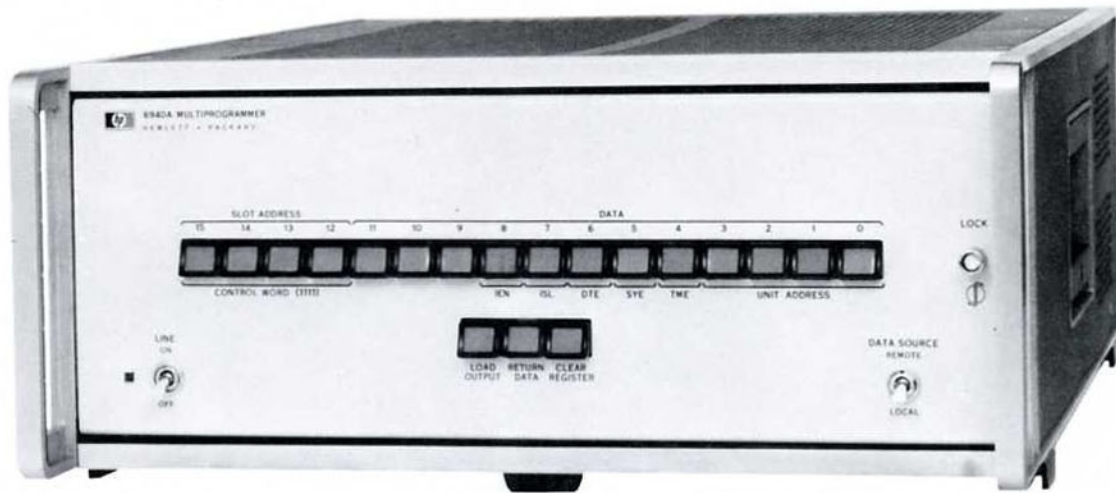

The 1900/6940A is a digitally programmable pulse generator system providing complete computer control of pulse parameters for fast, complete testing of components or devices with high accuracy, consistency, and repeatability. And the flexibility and expandability of this digital pulse system make it ideal for use in systems applications such as automatic checkout.

The system consists of a 1900A or 1901A mainframe Option 001, one or more 1900 series plug-ins with digital programming Option 005, a 10490A Interface Kit, and a 6940A Multiprogrammer. The system can be interfaced with a computer using a 16-bit parallel computer word for reliable, efficient control of pulse parameters. Program output cards are supplied with each 1900 series Option 005 which ensures fast economical system set-up. The 6940A equipped with a standard interface card will interface with binary sources employing TTL or DTL micro-circuit logic. An optional custom interface card is also available for special requirements. A computer interface kit (14543A) contains the necessary hardware and software to interface the multiprogrammer with 2100 series HP computers. Contact your local HP Sales Office for interface information for non HP computers.

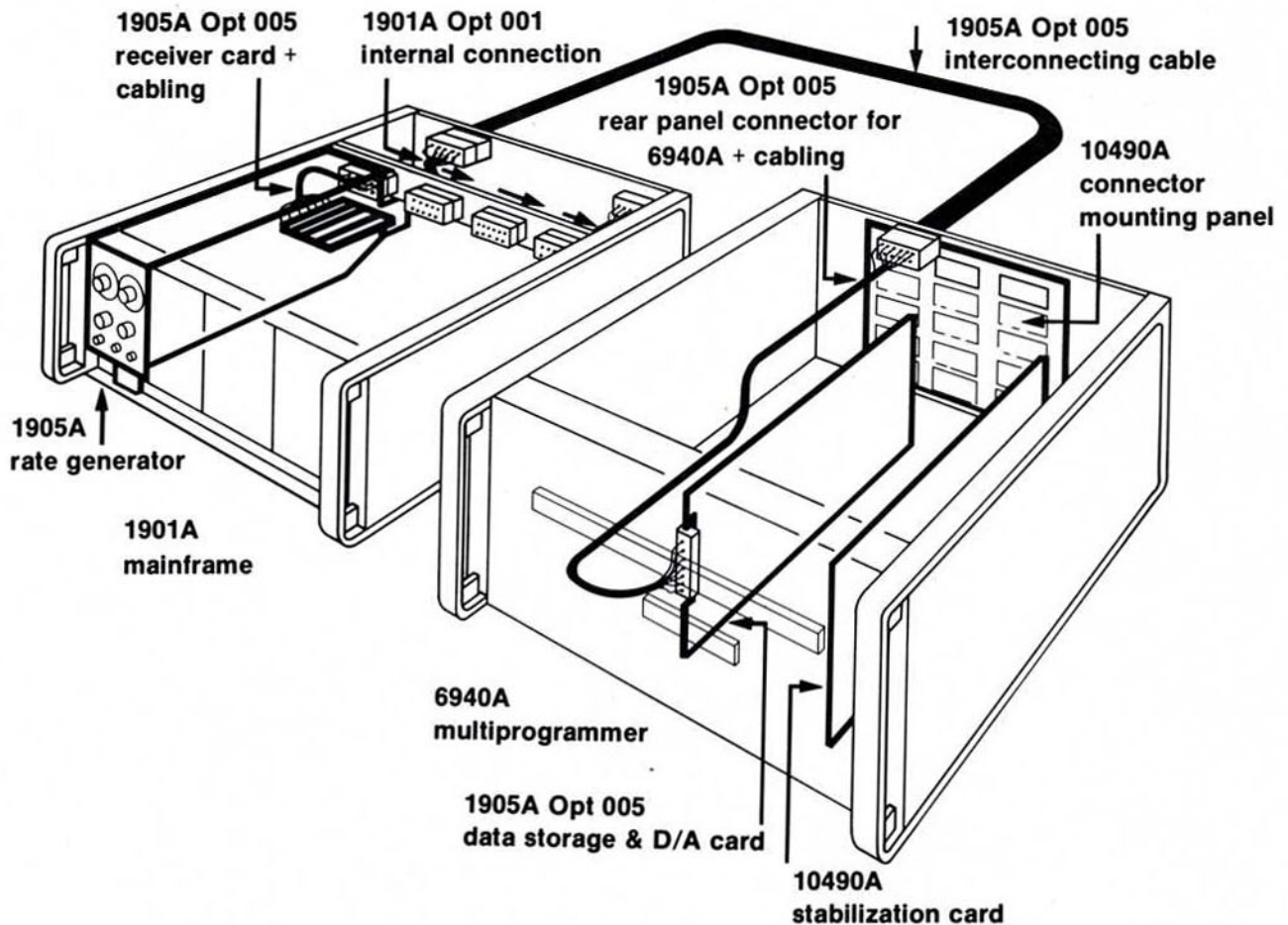

programming kits and accessories

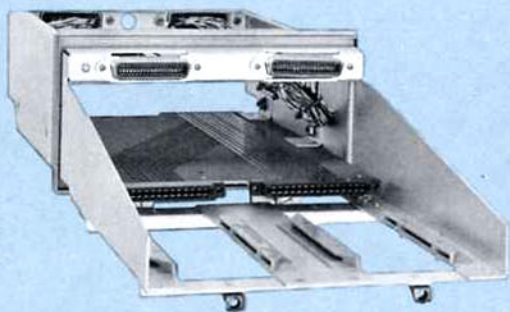
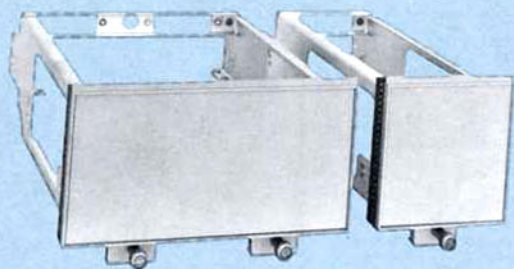

REMOTE CONTROL KITS

HP Part No. 019XX*-69501 provides field installation of Option 001 analog programming in the following 1900 series plug-ins: 1905A, 1906A, 1908A, 1909A, and 1921A.

HP Part No. 01915-69508 and 019XX*-69501 provide field installation of Option 001 analog programming in the following 1900 series plug-ins: 1915A, 1917A, and 1920A.

***Insert last two numbers of plug-in model number.**

HP Part No. 01900-69502 provides field installation of Option 001 in model 1900A or 1901A mainframe. Consists of internal cabling and connectors from plug-in to rear panel for digital or analog programming.

BLANK PLUG-INS

Blank plug-ins fill unused plug-in compartments for proper plug-in cooling and reduced RFI. They can also be used to construct special purpose units.

Model 10481A Quarter-size Blank Plug-in

Model 10482A Half-size Blank Plug-in

PLUG-IN EXTENDER

The Model 10484A Plug-in Extender provides access to plug-in components during calibration and servicing of an operating plug-in. Extender accommodates both quarter and half-size plug-ins and includes programming wiring.

CHASSIS SLIDE KIT

HP Part No. 01900-69501 consists of non-pivoting slides for the 1900A/1901A mainframes. Slides are adjustable in length from 20 to 22 inches (50.8 to 55.9 cm).

RACK MOUNT ADAPTER

Model 15179A Rack Adapter provides a rack mounting frame for two of the following pulse generators: Models 8011A, 8012A and 8013A.

FEEDTHROUGH TERMINATION

Model 10100C is a 50 ohm (± 1 ohm) feedthrough termination that can be used to terminate 50 ohm systems.

ADDER

Model 15104A Adder is useful when the outputs from two pulses must be combined to produce complex signals. It also is a signal splitter when one pulse source is required to drive two paths; or may be used as an attenuator, reducing signal amplitude approximately one half. Two or more Adders may be used to combine the outputs of three or more generators.

SPLITTER INVERTER

Model 15115A Splitter Inverter converts a single input pulse into two opposite polarity pulse outputs. This facilitates driving push-pull stages and flip-flops with one pulse source.

INVERTER

Model 15116A Inverter reverses polarity of input pulses. It extends the possible variety of complex pulse waveforms when used with Model 15104A Adder and Model 15115A Splitter Inverter.

TRANSITION TIME CONVERTER

Model 15171A Transition Time Converter adjusts the transition time of 1 ns pulses in seven steps up to 2.5 ns.