

# DC Programmable Electronic Loads

## IT8500plus Series User Manual



---

Model: IT8511+/IT8511A+/IT8511B+/IT8512+/IT8512A  
+/IT8512B+/IT8512C+/IT8512H+/IT8513A+/IT8513B  
+/IT8513C+/IT8514C+/IT8514B+/IT8516C+  
Version: 2.1

## Notices

© Itech Electronic, Co., Ltd. 2018  
No part of this manual may be reproduced in any form or by any means (including electronic storage and retrieval or translation into a foreign language) without prior permission and written consent from Itech Electronic, Co., Ltd. as governed by international copyright laws.

### Manual Part Number

IT8500+402008

### Revision

Second Edition: Mar. 15,

2018

Itech Electronic, Co., Ltd.

### Trademarks

Pentium is U.S. registered trademarks of Intel Corporation.

Microsoft, Visual Studio, Windows and MS Windows are registered trademarks of Microsoft Corporation in the United States and/or other countries and regions.

## Warranty

The materials contained in this document are provided “as is”, and is subject to change, without prior notice, in future editions. Further, to the maximum extent permitted by applicable laws, ITECH disclaims all warranties, either express or implied, with regard to this manual and any information contained herein, including but not limited to the implied warranties of merchantability and fitness for a particular purpose. ITECH shall not be held liable for errors or for incidental or indirect damages in connection with the furnishing, use or application of this document or of any information contained herein. Should ITECH and the user enter into a separate written agreement with warranty terms covering the materials in this document that conflict with these terms, the warranty terms in the separate agreement shall prevail.

### Technology Licenses

The hardware and/or software described herein are furnished under a license and may be used or copied only in accordance with the terms of such license.

### Restricted Rights Legend

Restricted permissions of the U.S. government. Permissions for software and technical data which are authorized to the U.S. Government only include those for custom provision to end users. ITECH follows FAR 12.211 (technical data), 12.212 (computer software), DFARS 252.227-7015 (technical data--commercial products) for national defense and DFARS 227.7202-3 (permissions for commercial computer software or computer software documents) while providing the customized business licenses of software and technical data.

## Safety Notices

### CAUTION

A CAUTION sign denotes a hazard. It calls attention to an operating procedure or practice that, if not correctly performed or adhered to, could result in damage to the product or loss of important data. Do not proceed beyond a CAUTION sign until the indicated conditions are fully understood and met.

### WARNING

A WARNING sign denotes a hazard. It calls attention to an operating procedure or practice that, if not correctly performed or adhered to, could result in personal injury or death. Do not proceed beyond a WARNING sign until the indicated conditions are fully understood and met.



### NOTE

A NOTE sign denotes important hint. It calls attention to tips or supplementary information that is essential for users to refer to.

## Quality Certification and Assurance

We certify that series IT8500+ electronic load meets all the published specifications at time of shipment from the factory.

## Warranty

ITECH warrants that the product will be free from defects in material and workmanship under normal use for a period of one (1) year from the date of delivery (except those described in the Limitation of Warranty below).

For warranty service or repair, the product must be returned to a service center designated by ITECH.















- The product returned to ITECH for warranty service must be shipped PREPAID. And ITECH will pay for return of the product to customer.
- If the product is returned to ITECH for warranty service from overseas, all the freights, duties and other taxes shall be on the account of customer.

## Limitation of Warranty

This Warranty will be rendered invalid in case of the following:

- Damage caused by circuit installed by customer or using customer own products or accessories;
- Modified or repaired by customer without authorization;
- Damage caused by circuit installed by customer or not operating our products under designated environment;
- The product model or serial number is altered, deleted, removed or made illegible by customer;
- Damaged as a result of accidents, including but not limited to lightning, moisture, fire, improper use or negligence.

## Safety Symbols

	Direct current		ON (power on)
	Alternating current		OFF (power off)
	Both direct and alternating current		Power-on state
	Protective conductor terminal		Power-off state
	Earth (ground) terminal		Reference terminal
	Caution, risk of electric shock		Positive terminal
	Warning, risk of danger (refer to this manual for specific Warning or Caution information)		Negative terminal
	Frame or chassis terminal	-	-

## Safety Precautions

The following safety precautions must be observed during all phases of operation of this instrument. Failure to comply with these precautions or specific warnings elsewhere in this manual will constitute a default under safety standards of design, manufacture and intended use of the instrument. ITECH assumes no liability for the customer's failure to comply with these precautions.

### WARNING

- Series IT8500+ electronic load supports 110V/220VAC input and need to switch the input voltage before operation.
- Do not use the instrument if it is damaged. Before operation, check the casing to see whether it cracks. Do not operate the instrument in the presence of inflammable gasses, vapors or dusts.
- The electronic load is provided with a power line during delivery and should be connected to a socket with a protective earth terminal. Before operation, be sure that the instrument is well grounded.
- Make sure to use the power cord supplied by ITECH.
- Check all marks on the instrument before connecting the instrument to power supply.
- Use electric wires of appropriate load. All loading wires should be capable of bearing maximum short-circuit current of electronic load without overheating. If there are multiple electronic loads, each pair of the power cord must be capable of bearing the full-loaded rated short-circuit output current
- Ensure the voltage fluctuation of mains supply is less than 10% of the working voltage range in order to reduce risks of fire and electric shock.
- Do not install alternative parts on the instrument or perform any unauthorized modification.
- Do not use the instrument if the detachable cover is removed or loosen.
- To prevent the possibility of accidental injuries, be sure to use the power adapter supplied by the manufacturer only.
- We do not accept responsibility for any direct or indirect financial damage or loss of profit that might occur when using the instrument.
- This instrument is used for industrial purposes, do not apply this product to IT power supply system.
- Never use the instrument with a life-support system or any other equipment subject to safety requirements.

### CAUTION

- Failure to use the instrument as directed by the manufacturer may render its protective features void.
- Always clean the casing with a dry cloth. Do not clean the internals.
- Make sure the vent hole is always unblocked.

## Environmental Conditions

The instrument is designed for indoor use and an area with low condensation. The table below shows the general environmental requirements for the instrument. The speed of fan will change intelligently by the temperature of radiator. When the temperature is up to 40°C, the fan will be on and adjust intelligently when temperature changes.



Environmental Conditions	Requirements
Operating temperature	0°C to 40°C
Operating humidity	20%-80% (non-condensation)
Storage temperature	-20°C to 70 °C
Altitude	Operating up to 2,000 meters
Pollution degree	Pollution degree 2
Installation category	II



### Note

To make accurate measurements, allow the instrument to warm up for 30 min before operation.

## Regulatory Markings

	The CE mark indicates that the product complies with all the relevant European legal directives. The specific year (if any) affixed refers to the year when the design was approved.
	The instrument complies with the WEEE Directive (2002/96/EC) marking requirement. This affixed product label indicates that you must not discard the electrical/electronic product in domestic household waste.
	This symbol indicates the time period during which no hazardous or toxic substances are expected to leak or deteriorate during normal use. The expected service life of the product is 10 years. The product can be used safely during the 10-year Environment Friendly Use Period (EFUP). Upon expiration of the EFUP, the product must be immediately recycled.

## Waste Electrical and Electronic Equipment (WEEE) Directive



2002/96/EC Waste Electrical and Electronic Equipment (WEEE) Directive

This product complies with the WEEE Directive (2002/96/EC) marking requirement. This affix product label indicates that you must not discard the electrical/electronic product in domestic household waste.  
Product Category

With reference to the equipment classifications described in the Annex I of the WEEE Directive, this instrument is classified as a “Monitoring and Control Instrument”.

To return this unwanted instrument, contact your nearest ITECH office.

## Compliance Information

Complies with the essential requirements of the following applicable European Directives, and carries the CE marking accordingly:

- Electromagnetic Compatibility (EMC) Directive 2014/30/EU
- Low-Voltage Directive (Safety) 2014/35/EU

Conforms with the following product standards:

### EMC Standard

IEC 61326-1:2012/ EN 61326-1:2013 <sup>123</sup>

#### Reference Standards

CISPR 11:2009+A1:2010/ EN 55011:2009+A1:2010 (Group 1, Class A)

IEC 61000-4-2:2008/ EN 61000-4-2:2009

IEC 61000-4-3:2006+A1:2007+A2:2010/ EN 61000-4-3:2006+A1:2008+A2:2010

IEC 61000-4-4:2004+A1:2010/ EN 61000-4-4:2004+A1:2010

IEC 61000-4-5:2005/ EN 61000-4-5:2006

IEC 61000-4-6:2008/ EN 61000-4-6:2009

IEC 61000-4-11:2004/ EN 61000-4-11:2004

1. The product is intended for use in non-residential/non-domestic environments. Use of the product in residential/domestic environments may cause electromagnetic interference.
2. Connection of the instrument to a test object may produce radiations beyond the specified limit.
3. Use high-performance shielded interface cable to ensure conformity with the EMC standards listed above.

### Safety Standard

IEC 61010-1:2010/ EN 61010-1:2010

# Content

Quality Certification and Assurance .....	i
Warranty .....	i
Limitation of Warranty .....	i
Safety Symbols .....	i
Safety Precautions .....	ii
Environmental Conditions .....	iii
Regulatory Markings .....	iii
Waste Electrical and Electronic Equipment (WEEE) Directive .....	iii
Compliance Information .....	v
<b>Chapter1 Inspection and Installation .....</b>	<b>1</b>
1.1 Verifying the Shipment .....	1
1.2 Instrument Size Introduction .....	3
1.3 Adjustment of Load Handle .....	6
1.4 Disassembly of Load Handle .....	7
1.5 Rack Mounting .....	8
1.6 Connect the Power Cord .....	8
1.7 Connect the Device Under Test (DUT) .....	9
<b>Chapter2 Quick Start .....</b>	<b>12</b>
2.1 Brief Introduction .....	12
2.2 Product Feature .....	12
2.3 Front Panel Introduction .....	13
2.4 Front Panel Keys .....	14
2.5 Combination Keys .....	15
2.6 VFD Annunciators .....	15
2.7 Rear Panel Introduction .....	16
2.8 Power-on Selftest .....	17
<b>Chapter3 Functions and Characteristics .....</b>	<b>20</b>
3.1 Local Mode/Remote Mode .....	20
3.2 Operation Mode .....	20
3.2.1 Constant Current Mode (CC) .....	20
3.2.2 Constant Voltage Mode (CV) .....	21
3.2.3 Constant Resistance Mode (CR) .....	22
3.2.4 Constant Power Mode (CW) .....	23
3.3 Input On/Off Control .....	23
3.4 Key Lock Function .....	24
3.5 Short-circuit Analog Function .....	24
3.6 System Menu (System) .....	24
3.7 Config Menu (Config) .....	26
3.8 Trigger Function .....	27
3.9 LIST Operation .....	28
3.10 Test Function .....	30
3.10.1 Transient Test Function .....	30
3.10.2 OCP Test Function .....	33
3.10.3 OPP Test Function .....	34
3.10.4 Battery Discharge Test .....	35
3.10.5 CR-LED Test Function .....	37
3.10.6 Measurement of Voltage Rise Time .....	39
3.11 Saving and Recalling Settings .....	39
3.12 VON Function .....	40
3.13 Protection Function .....	41
3.14 Current Monitoring (I Monitor) .....	42
3.15 Ripple Function .....	42
<b>Chapter4 Automatic Test Function .....</b>	<b>44</b>
4.1 Introduction .....	44
4.2 Automatic Test Mode Switching .....	44



---

4.2.1 Test Mode for IT8500+ .....	45
4.2.2 Test Mode for IT8500.....	48
<b>Chapter5 Specifications .....</b>	<b>51</b>
Specifications .....	51
Supplementary Characteristics .....	65
<b>Chapter6 Communication Interfaces .....</b>	<b>66</b>
6.1 Communication Modules Introduction.....	66
6.2 Communication with PC.....	68
<b>Appendix.....</b>	<b>70</b>
Specifications of Red and Black Test Lines .....	70

# Chapter1 Inspection and Installation

## 1.1 Verifying the Shipment

Unpack the box and check the contents before operating the instrument. If wrong items have been delivered, if items are missing, or if there is a defect with the appearance of the items, contact the dealer from which you purchased the instrument immediately. The package contents include:

### Checklist of Package Contents

Item	Qty.	Model	Remarks
Electronic Loads	x1	IT8500+ series	The IT8500+ series include: IT8511+/IT8511A+/IT8511B+/IT8512+/IT8512A+/IT8512B+/IT8512C+/IT8512H+/IT8513A+/IT8513B+/IT8513C+/IT8514C+/IT8514B+/IT8516C+
Power cord	x1	IT-E171/IT-E172/IT-E173/IT-E174	User may select an appropriate power cord that matches the specifications of power socket used in the area. See the Section <b>Connecting the Power Cord</b> for details.
CD	x1	-	It contains IT8500+ electronic load User's Manual, Programming Guide and other user documentations.
Ex-factory Test Report	x1	-	It is the test report of the instrument before delivery.



### NOTE

Upon verification of the shipment, keep the package and relevant contents thereof in a safe place. When returning the instrument for warranty service or repair, the specified packing requirements shall be met.

The IT8511+/IT8511A+/IT8511B+/IT8512+/IT8512A+/IT8512B+/IT8512H+/IT8512C+/IT8512H+/IT8512C+/IT8513A+/IT8513C+ models have separately sold optional accessories. Please refer to **Chapter5 Communication Interfaces** for details of each accessory.

Device Name	Model	Accessories Description
Rack mount kit	IT-E151	Select this accessory when the user needs to install the instrument on a special bracket.
RS232 Communication Module	IT-E121	Select this accessory when users need to use the standard RS232 extension cable to connect the DB9 interface connector of the DC load and the RS-232 interface connector of computer for the communication.
RS232 Communication Module	IT-E121A	The DB9 interface connector of the RS232 changes from female to male, so that can be directly connected to the standard LAN interface.

Device Name	Model	Accessories Description
USB Communication Module	IT-E122	Select this accessory when you need to use IT-E122 and an a standard USB extension cable (type B female connector at one end and type A at one end) to connect the DB9 interface connector of the DC load and the USB interface connector of computer for the communication.
RS485 Communication Module	IT-E123	Select this accessory when you need to use the communication module IT-E123 and a standard RS485-RS232 conversion cable to connect the DB9 interface connector of the DC load and the RS-232 interface connector of computer for the communication.

## 1.2 Instrument Size Introduction

The instrument should be installed at well-ventilated and rational-sized space. Please select appropriate space for installation based on the electronic load size.

IT8500+ series electronic load different models are not the same size, the detail size of the electronic load is shown as below.

---

### IT8511+/IT8511A+/IT8511B+/IT8512+/IT8512B+/IT8512C+/IT8512H+ Model

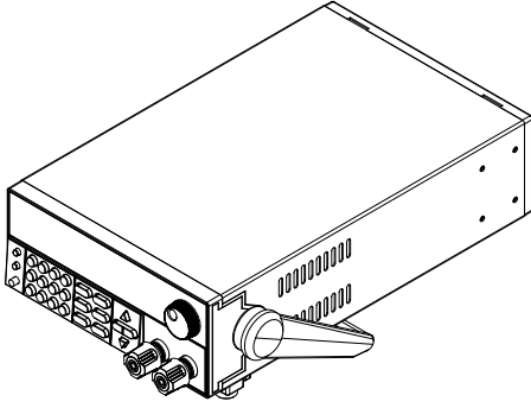

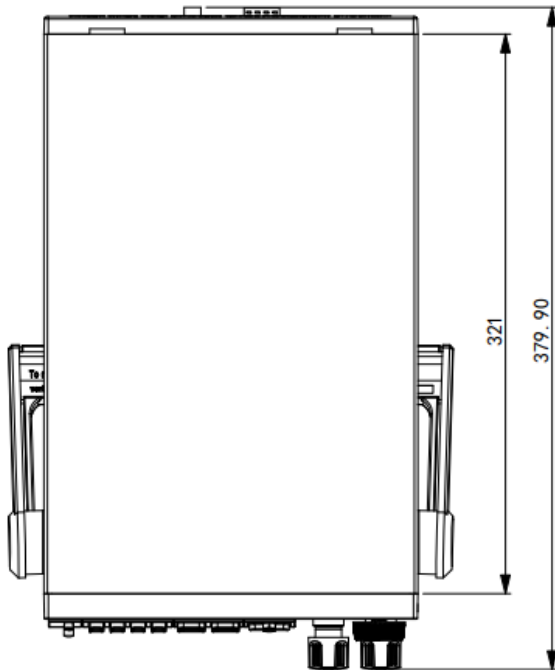
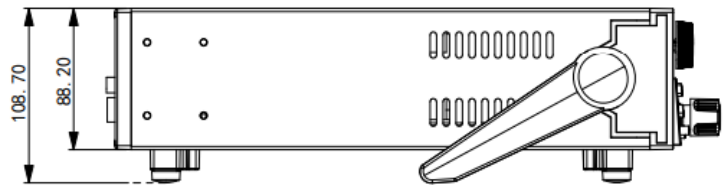
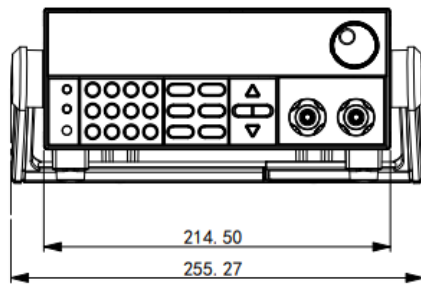

---

#### Detailed Dimension Drawing

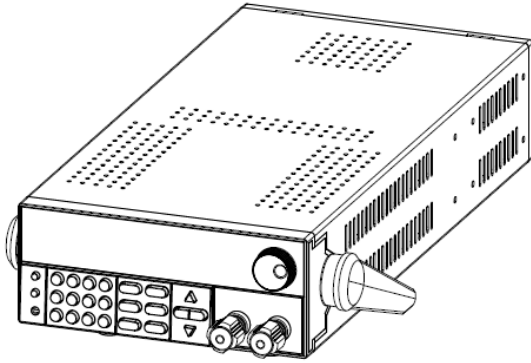

---

**IT8513A+/IT8513C+ Model**



---

**Detailed Dimension Drawing**

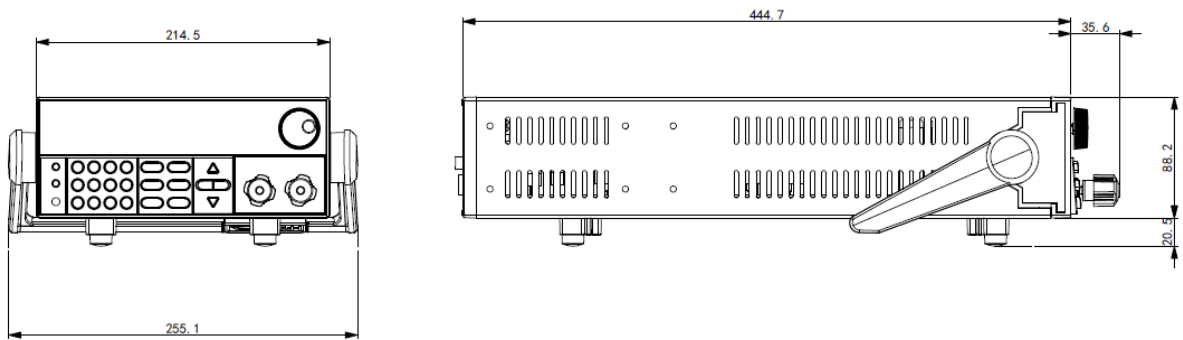

---

**IT8513B+/IT8514B+/ IT8514C+ Model**

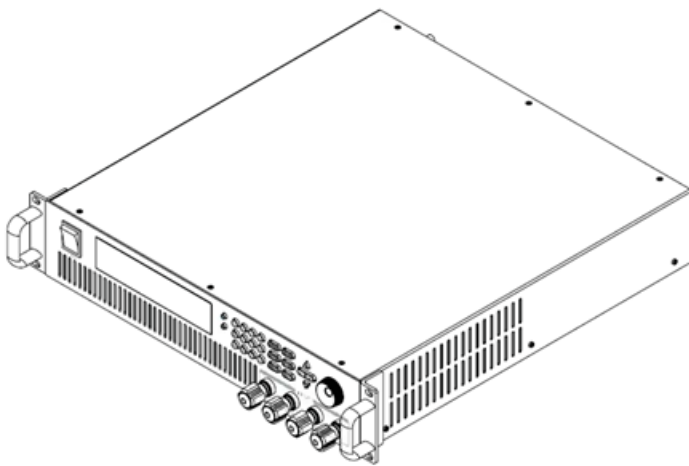

---

**Detailed Dimension Drawing**

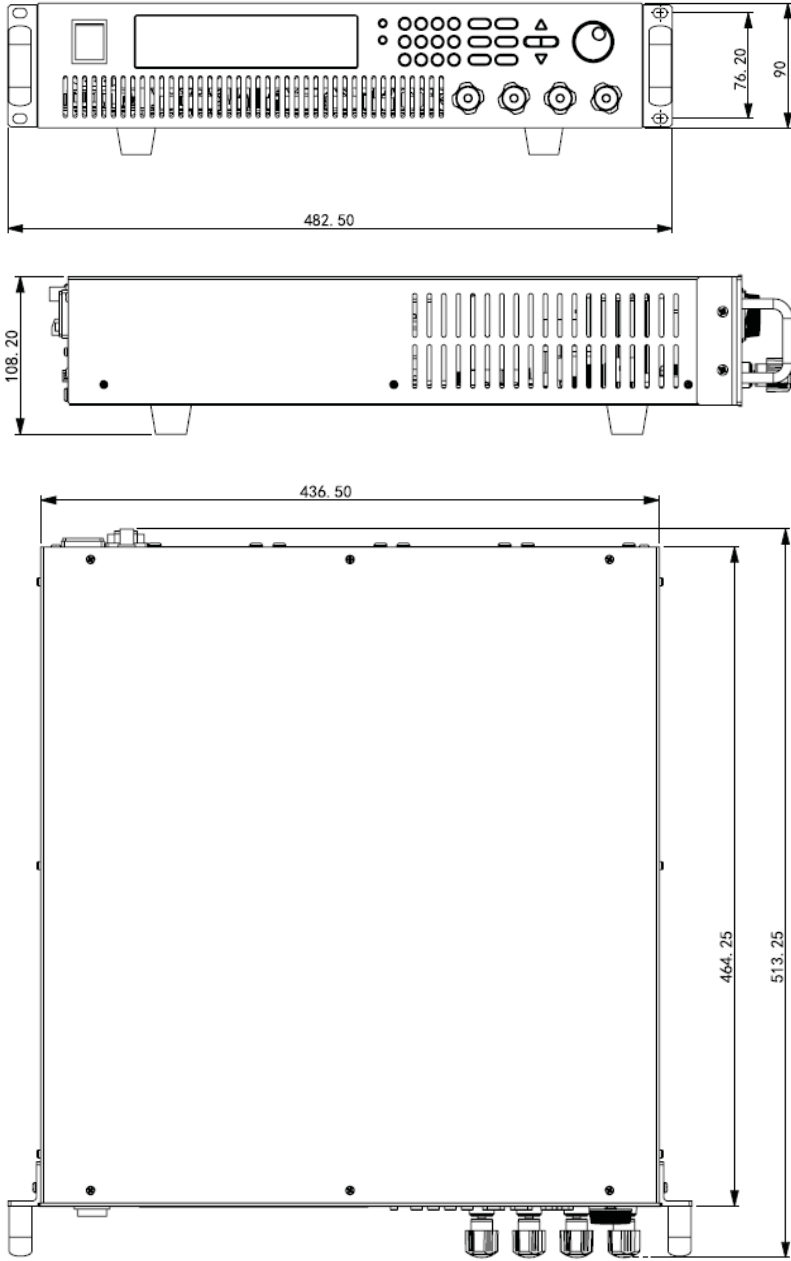

**IT8516C+ Model**

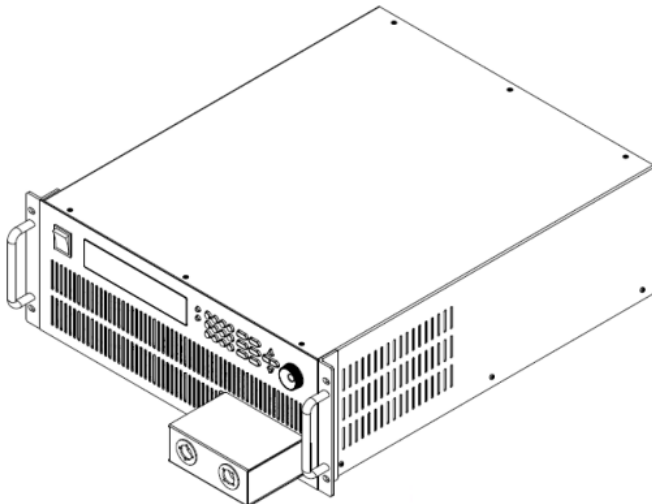

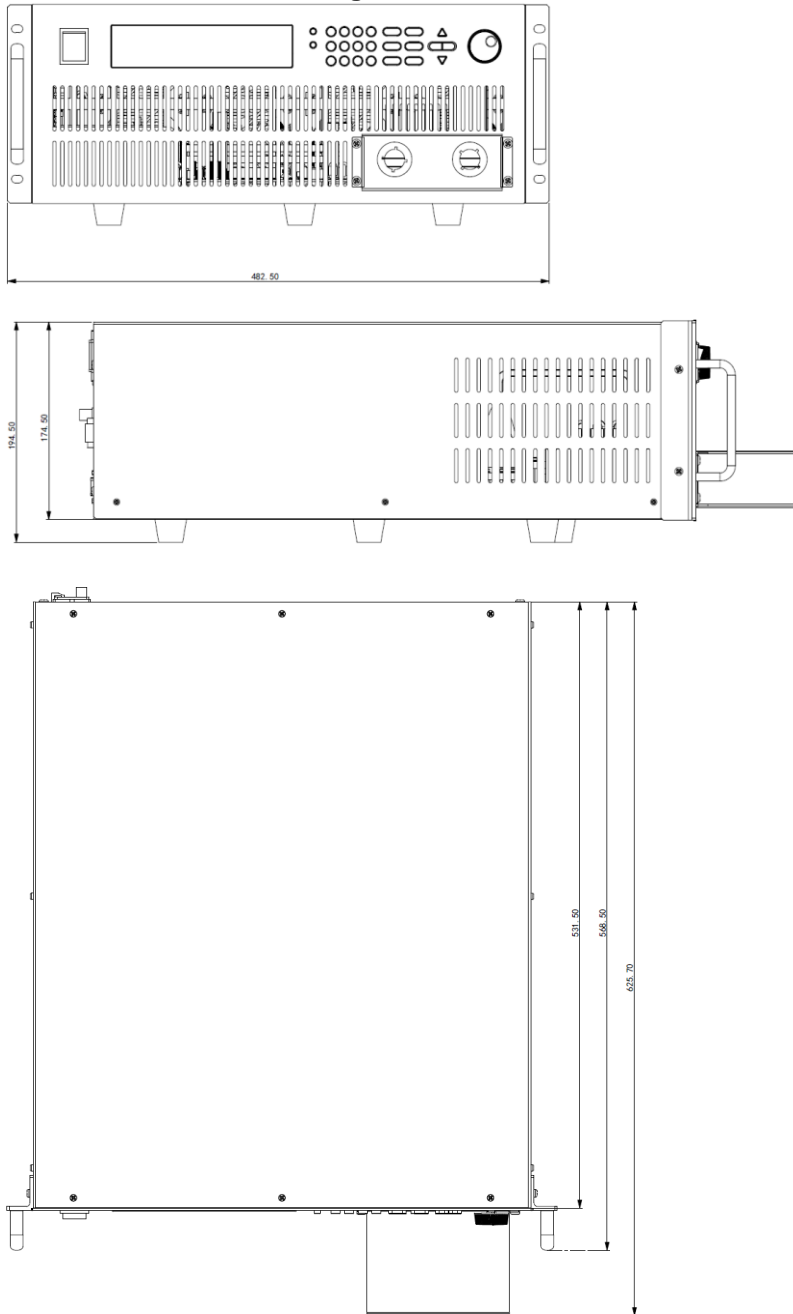
**Detailed Dimension Drawing**

### 1.3 Adjustment of Load Handle

IT8511+/IT8511A+/IT8511B+/IT8512+/IT8512A+/IT8512B+/IT8512C+/IT8512H /IT8513A+/IT8513C+ series loads are equipped with a handle for user to easily carry and place it.

The load handle may be adjusted based on three methods (as shown in icons below). Be sure that appropriate force is applied to adjust the load handle to appropriate position.

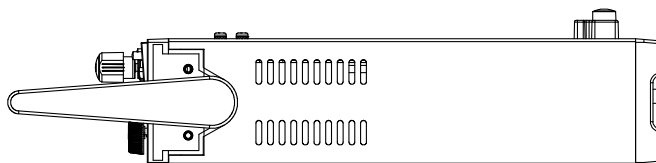

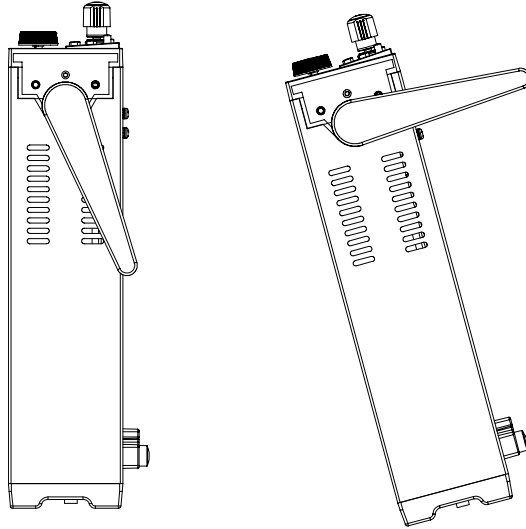

## 1.4 Disassembly of Load Handle

Please disassemble the load handle before installing equipment on the support.

Disassembly steps:

1. Adjust the handle to the position as shown in the figure below.

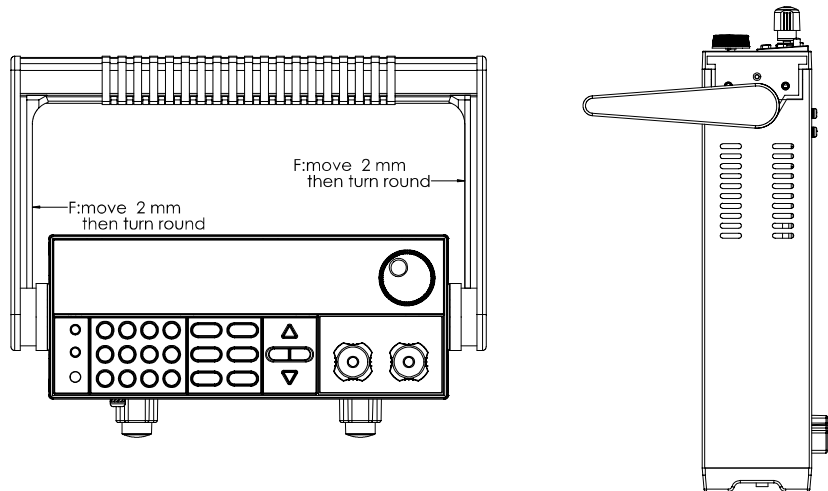

### NOTE

To easily disassemble handle, align the locking mouth and locking device, which is between the handle and the instrument.

2. Align the locking mouth, and pull out the handle towards two sides.



### NOTE

Do not use too much force and mind your hands during disassembly of load handle.



## 1.5 Rack Mounting

IT8511+/IT8511A+/IT8511B+/IT8512+/IT8512A+/IT8512B+/IT8512C+/IT8512H+/IT8513A+/IT8513C+ loads can be installed on standard 19-inch rack. ITECH provides user with IT-E151/IT-E151A rack, as an optional mount kit. The detailed operation please refer to the User Manual of your mount kit.

IT8513B+/IT8514B+/IT8514C+/IT8516C+ need not mount on rack, they can be installed on cabinet directly by screw.

## 1.6 Connect the Power Cord

Before connecting the power cord

To prevent electric shock and damage to the instrument, observe the following precautions.

### WARNING

- Before connecting the power cord, please confirm the 110V / 220V transfer switch to ensure that the switch of the load matches the supply voltage. Otherwise, the instrument may be damaged.
- Connect the power cord after checking that the power switch of the instrument is turned OFF. Only use the power cord supplied as a standard accessory.
- To prevent electric shock, be sure to take protective earthing. Please connect the power cable to the socket with the protective earth terminal.
- Do not use the extension cord without protective grounding function, otherwise the protection function will be invalid.
- Please use the AC power socket matching the power cord shipped with the box and take the protective earthing measures. If you can not use a suitable AC power cord, do not use the instrument.

Power cord type

Select from the following Schedule of Power Cord Specifications an appropriate power cord that matches the voltage for the area in which you use the instrument. If the power cord included in the instrument you purchased does not match the voltage, contact the dealer or manufacturer for change.

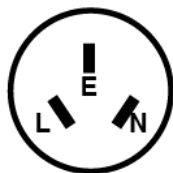

China  
IT-E171



United States &  
Canada  
IT-E172

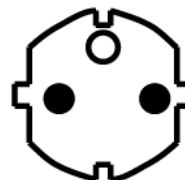

Europe  
IT-E173



England  
IT-E174

AC input level

A transfer switch is selectable on the rear panel:

- Option Opt.1: 220V  $\pm$ 10% 50Hz/60Hz
- Option Opt.2: 110V  $\pm$ 10% 50Hz/60Hz

## Steps

1. Check whether the power switch of the instrument is turned OFF.
2. Connect one end of the power cord to the AC input connector on the rear panel of the instrument.
3. Connect the other end of the power cable to the socket configured with protective earth.

## 1.7 Connect the Device Under Test (DUT)

### Before connecting the DUT

To prevent electric shock and damage to the instrument, observe the following precautions.

#### WARNING

- Before connecting the DUT, turn off the power of the test loop to avoid the risk of electric shock during connection.
- To avoid electrical shock, before testing, please make sure the rating values of the testing cables, and do not measure the current that higher than the rating value.
- Always use test cables provided by ITECH to connect the equipment. If test cables from other factories are used, please check that the test cable can withstand maximum current.

### Specification

Test cables are not standard accessories of the instrument. Please select optional red and black test cables for individual sales based on the maximum current value. For specifications of test cables and maximum current values, refer to “**Specifications of Red and Black Test Lines**” in “**Appendix**”.

### Introduction of Binding Posts

The IT8500+ series (except IT8516C+) load front panel contains the following terminals and the maximum rated current of the terminal at position (A) is the maximum rated input current of the instrument. Securely fasten all wires by hand-tightening the binding posts. You can also insert standard banana plugs into the front of the connectors as shown in (B), and the maximum rated current at (B) is 10 A.

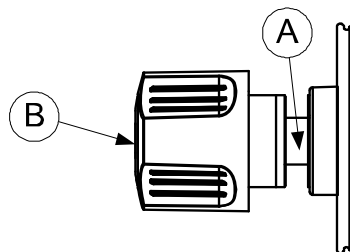

### Local measurement

1. Check whether the power switch is in Off position.
2. (Optional) Unlock the load input terminal cover.
3. Unscrew the screws of the input terminals. Connect the red and black test cables to the input terminals. Re-tighten the screws.

When maximum current that one test cable can withstand fails to meet the

current rated current, use several pieces of red and black test cables. For example, the maximum current is 1,200A, then 4 pieces of 360A red and black cables are required.

4. (Optional) Install the load input terminal cover.
5. Directly connect the other end of the red and black cables to the DUT terminal.

## Remote measurement

Remote sensing is used to counteract the effect of lead resistance. For example, if you connect a power supply to the DC Load, the voltage at the power supply's terminals will not be the same as the voltage at the DC Load's terminals if there is a current flowing because of the finite resistance from the wires. Using remote sensing, you can sense the voltage at the power supply's terminals, effectively removing the effect of the voltage drop in the connection wire.

When using remote sensing, the power displayed by the instrument includes both the power dissipated inside the instrument and the power dissipated in the leads from the power supply to the DC Load's input terminals.

Sense terminals in the rear panel displayed as follows:

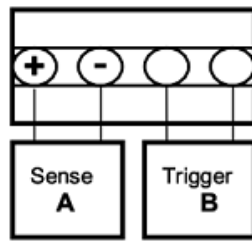

**Remote Sensing: SENSE (+) and SENSE (-)** are the remote sensing inputs. By eliminating the effect of the inevitable voltage drop in the DC load leads, remote sensing provides greater accuracy by allowing the DC load to regulate directly at the source's output terminals.

Before using the remote measurement function, you must first set the load to remote measurement mode. The steps are as follows:

1. Press [Shift] + [9] key into the menu.
2. Press Right/Left key to select SENSE, press [Enter] key to confirm.
3. Select ON, then the remote sense function has been set.

### Note:

When not using the remote measurement function, press the OFF key to close the remote measurement mode.

4. Refer the following diagram to connect test cables.

Wiring Diagram for Remote Sensing:

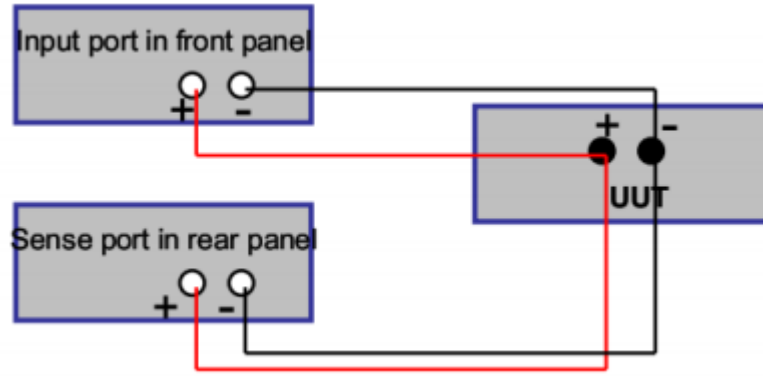
**Note:**

Test cables and Sense cables should be as short as possible, and Sense cables should be twisted together.

## Chapter2 Quick Start

This chapter introduces the front panel, the rear panel, key functions and VFD display function of the electronic load, make sure that you can quickly know the appearance, instruction and the key function before you operate the load. Help you better use this series of loads.

### 2.1 Brief Introduction

IT8500+ series is a single-channel programmable electronic load. With power ranges from 150W to 3000W. The user can perform online voltage measurements and adjustments or simulate short circuit test using the simple keypad on the front panel. IT8500+ also offers a full-featured battery mode for discharging test. IT8500+ series DC load is a versatile instrument for static and dynamic testing of power supplies, batteries, AC-DC/DC-DC converters, battery chargers, provides user the best testing solution.

Model	Voltage	Current	Power	Communication Interface
IT8511+	120V	30A	150W	DB9(TTL)
IT8511A+	150V	30A	150W	DB9(TTL)
IT8511B+	500V	10A	150W	DB9(TTL)
IT8512+	120V	30A	300W	DB9(TTL)
IT8512A+	150V	30A	300W	DB9(TTL)
IT8512B+	500V	15A	300W	DB9(TTL)
IT8512C+	120V	60A	300W	DB9(TTL)
IT8512H+	800V	5A	300W	DB9(TTL)
IT8513A+	150V	60A	400W	DB9(TTL)
IT8513B+	500V	30A	600W	Standard USB/RS232
IT8513C+	120V	120A	600W	DB9(TTL)
IT8514B+	500V	60A	1500W	Standard USB/RS232
IT8514C+	120V	240A	1500W	Standard USB/RS232
IT8516C+	120V	240A	3000W	Standard USB/RS232

### 2.2 Product Feature

- High-visibility vacuum fluorescent display (VFD)
- Measurement resolution: 0.1mV,0.1mA
- Voltage and current measurement speed: up to 40KHZ
- Four operation modes: CV (Constant Voltage), CC, CR,CW
- Battery test function
- OCP test, OPP test
- Measurement function: measuring voltage rise and fall time
- Automatic test function
- List mode, which can simulate a variety of load state changes
- Short circuit function
- Remote sense function
- Memory capacity to save/recall setting parameters: 100 registers
- Intelligent fans
- Build-in Buzzer as alarm signal
- Power off memory function

## 2.3 Front Panel Introduction

IT8500+ series electronic load different models have different front panels, the front panels and keyboards of different models are shown as below.

### IT8511+/IT8511A+/IT8511B+/IT8512+/IT8512A+/IT8512B+/IT8512C+/IT8512H+/IT8513A+/IT8513C+ Model

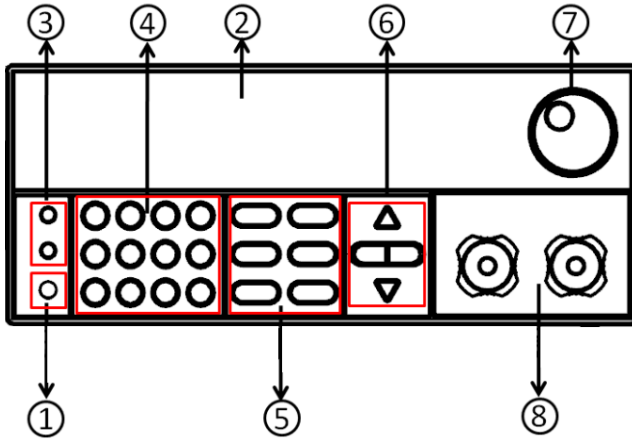

- |   |  |
|---|--|
| ① Power switch  | ⑤ Function key:<br>Set the operation mode<br>Control the input state: On/Off |
| ② Vacuum fluorescent display (VFD)  | ⑥ Direction function   |
| ③ Compound key and the local switch key   | ⑦ Rotary knob  |
| ④ Number key:<br>Set the parameters value, achieve the menu's function by key combination | ⑧ Input terminal   |

### IT8513B+/IT8514B+/IT8514C+ Model

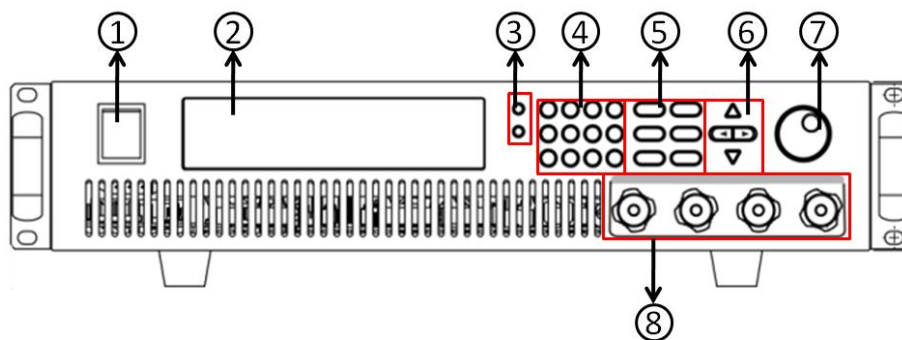

- |   |  |
|---|--|
| ① Power switch  | ⑤ Function key:<br>Set the operation mode<br>Control the input state: On/Off |
| ② Vacuum fluorescent display (VFD)  | ⑥ Direction function   |
| ③ Compound key and the local switch key   | ⑦ Rotary knob  |
| ④ Number key:<br>Set the parameters value, achieve the menu's function by key combination | ⑧ Input terminal   |

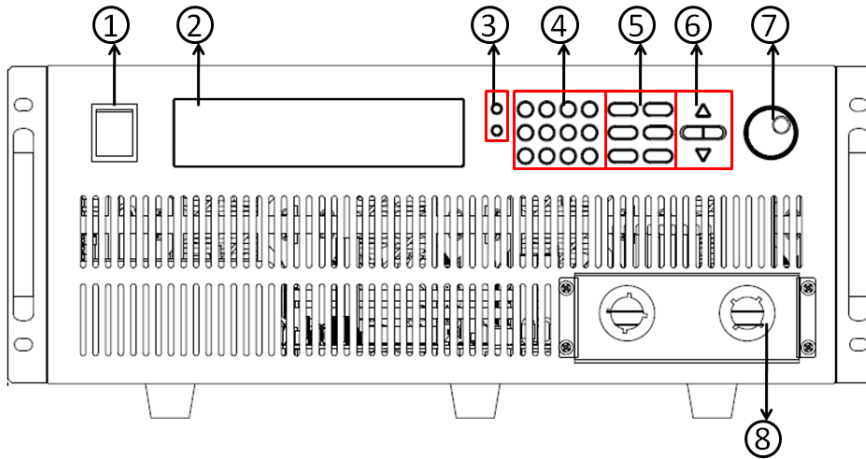





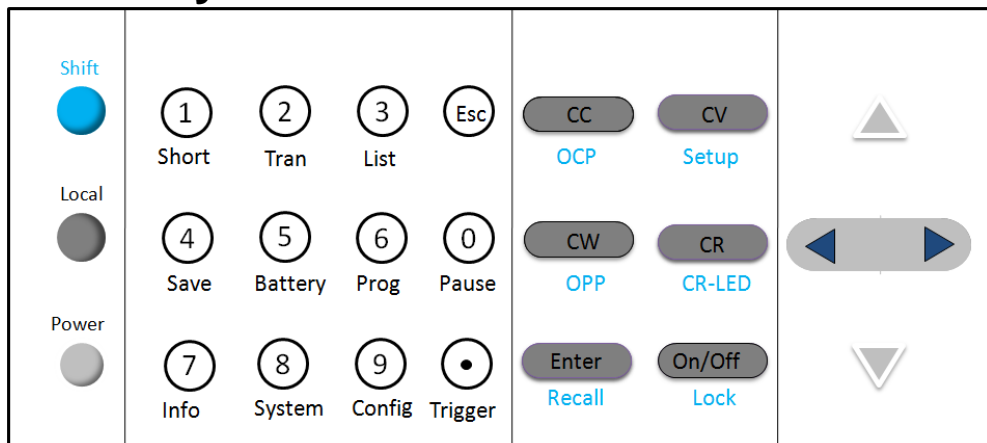

**IT8516C+ Model**

- |   |  |
|---|--|
| ① Power switch  | ⑤ Function key:<br>Set the operation mode<br>Control the input state: On/Off |
| ② Vacuum fluorescent display (VFD)  | ⑥ Direction function   |
| ③ Compound key and the local switch key   | ⑦ Rotary knob  |
| ④ Number key:<br>Set the parameters value, achieve the menu's function by key combination | ⑧ Input terminal   |

## 2.4 Front Panel Keys



(Blue-green)	The Shift composite button is used in combination with other buttons to implement the functions marked under these buttons.
(Gray)	Local button is used to switch local and remote mode.
(Gray-white)	Power on/off button.
0 ~ 9	Enter the digits 0 to 9.
.	Decimal point
ESC	The escape button
CC	Select the constant current mode and set the input current value.

	Select the constant voltage mode and set the input voltage value.
	Select the constant resistance mode and set the input resistance value.
	Select the constant power mode and set the input power value.
	Enter the selected value or setting.
	Turn on or turn off the input of the load.
	The scroll up key is used to select the menu item.
	The scroll down key is used to select the menu item.
	Move the left and right keys to adjust the cursor to the specified position when setting the value.

## 2.5 Combination Keys

Press **[Shift]** button first and then other keys to achieve all kinds functions in the following table.

<b>[Shift]+[1]</b> (Short)	Start or stop the short circuit test.
<b>[Shift]+[2]</b> (Tran)	Set the transient operation parameters.
<b>[Shift]+[3]</b> (List)	Set the LIST operation parameters.
<b>[Shift]+[4]</b> (Save)	Store the parameter value of the currently load. Including: voltage, current and power values, and so on.
<b>[Shift]+[5]</b> (Battery)	Battery test function.
<b>[Shift]+[6]</b> (Prog)	Automatic test function.
<b>[Shift]+[7]</b> (Info)	Displays the model number, version number, and serial number of the electronic load.
<b>[Shift]+[8]</b> (System)	System menu setting
<b>[Shift]+[9]</b> (Config)	Configure menu setting
<b>[Shift]+[0]</b> (Pause)	Pressing this button during the running of the automatic test indicates that the automatic test is suspended.
<b>[Shift]+[⊙]</b> (Trigger)	Cause an immediate trigger.
<b>[Shift]+[CC]</b> (OCP)	Enter OCP test function.
<b>[Shift]+[CV]</b> (Setup)	Set detailed parameters in CC/CV/CW/CR mode.
<b>[Shift]+[CW]</b> (OPP)	Enter OPP test function.
<b>[Shift]+[CR]</b> (CR-LED)	CR-LED function setting
<b>[Shift]+[Enter]</b> (Recall)	Recall the load parameter values that have been stored. Includes: voltage, current and power settings, and so on.
<b>[Shift]+[On/Off]</b> (Lock)	Key lock function

## 2.6 VFD Annunciators

<b>OFF</b>	The load input is off.	<b>Error</b>	An error has occurred.
<b>CC</b>	Constant current mode	<b>Trig</b>	Waiting for the trigger signal.



<b>CV</b>	Constant voltage mode	<b>Sense</b>	Remote sensing is turned on.
<b>CR</b>	Constant resistance mode	<b>Prot</b>	Protection function is turned on.
<b>CW</b>	Constant power mode	<b>Auto</b>	Voltage range automatically selected function is turned on.
<b>Rmt</b>	Instrument is in the remote state.	<b>Lock</b>	The keyboard is locked.
<b>Timer</b>	LOAD ON timer is turned on.	<b>Shift</b>	Shift button has been pressed.

## 2.7 Rear Panel Introduction

IT8500+ series electronic load different models have different rear panels, the rear panels and keyboards of different models are shown as below.

### IT8511+/IT8511A+/ IT8511B+/IT8512+/ IT8512B+/IT8512C+/IT8512H+ Model

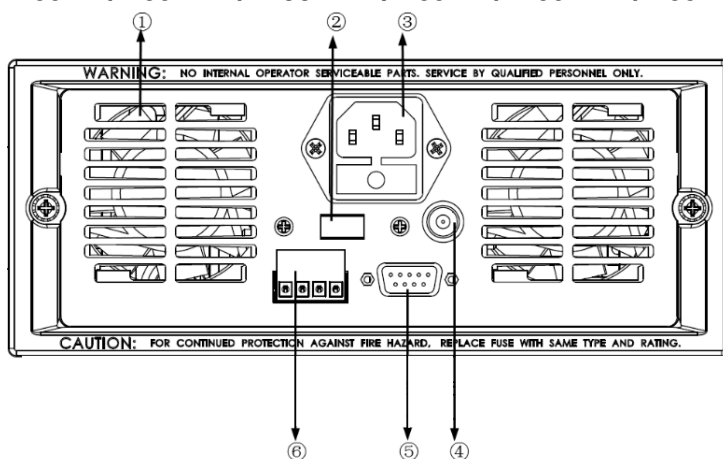

- ① Thermal window
- ② Line voltage selection switch (110V/220V )
- ③ 3 pin IEC320 AC input connector
- ④ Current monitoring terminal
- ⑤ 9-Pin serial port interface connector
- ⑥ 4 pin trigger and remote sensing connector

### IT8513A+/IT8513C+ Model

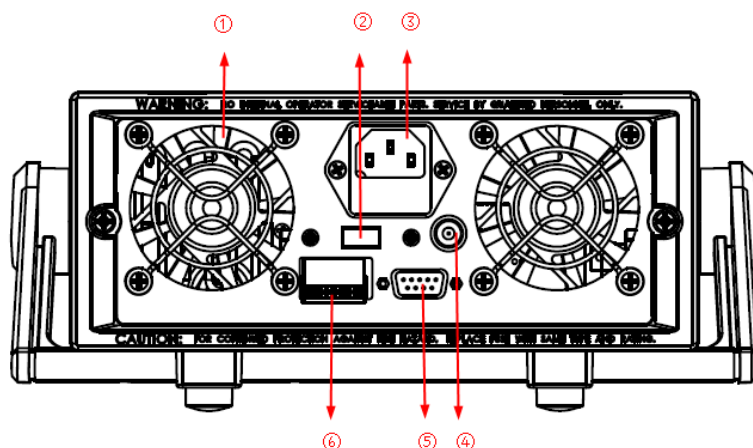

- ① Thermal window
- ② Line voltage selection switch (110V/220V )
- ③ 3 pin IEC320 AC input connector
- ④ Current monitoring terminal
- ⑤ 9-Pin serial port interface connector
- ⑥ 4 pin trigger and remote sensing connector

## ③ 3 pin IEC320 AC input connector

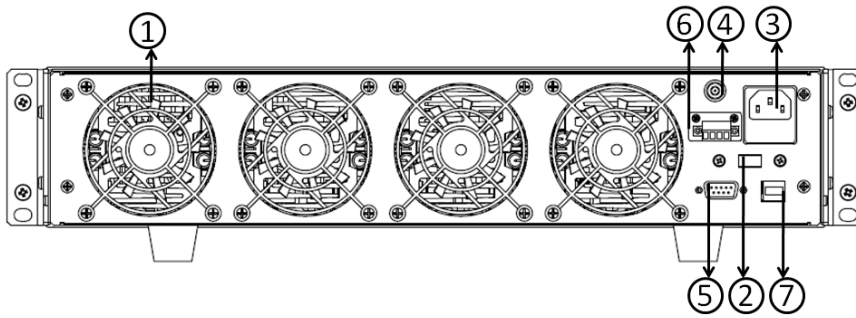
**IT8513B+/IT8514B+/IT8514C+Model**

- |   |  |
|---|--|
| ① Thermal window                            | ⑤ RS232 communication cable interface        |
| ② Line voltage selection switch (110V/220V) | ⑥ 4 pin trigger and remote sensing connector |
| ③ 3 pin IEC320 AC input connector           | ⑦ USB communication cable interface          |
| ④ Current monitoring terminal               |  |

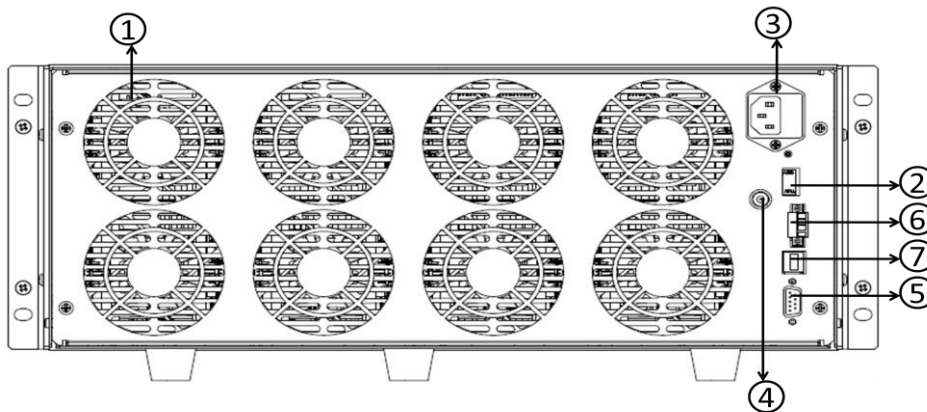
**IT8516C+Model**

- |   |  |
|---|--|
| ① Thermal window                            | ⑤ RS232 communication cable interface        |
| ② Line voltage selection switch (110V/220V) | ⑥ 4 pin trigger and remote sensing connector |
| ③ 3 pin IEC320 AC input connector           | ⑦ USB communication cable interface          |
| ④ Current monitoring terminal               |  |

## 2.8 Power-on Selftest

A successful test process indicates that the instrument meets the factory specifications and can be operated well.

Before operation, please confirm that you have fully understood the safety instructions.

**WARNING**

- To avoid burning out, be sure to confirm that power voltage matches with supply voltage.
- Be sure to connect the main power socket to the power outlet of protective grounding. Do not use terminal board without protective grounding. Before operation, be sure that the power supply is well grounded.

- To avoid burning out, pay attention to marks of positive and negative polarities before wiring.

## Selftest steps

Normal selftest procedures:

1. Correctly connect the power cord. Press [ **Power** ] key to start up.
2. After selftest, VFD display information below.

0.0000V	0.0000A
0.00W	CC=0.000A
OFF CC	Auto

Information description:

- The first line display actual voltage and current value.
  - The second line display the actual power value and the setting current/voltage/power/resistance value.
  - The third line display the input state/operation mode.
3. Press [ **Shift** ] + [ **7** ], VFD display products information. You can press direction buttons to examine product's model/SN/software version.

## Error Information References

The following error information may occur when an error occurs during Power On self-test:

- If the EEPROM was damaged, the VFD will display "Eeprom Fail".
- If the latest operation data in EEPROM is lost, then VFD will display "Config Data Lost".
- If the calibration data in EEPROM is lost, then VFD will display "Cal data lost".
- If the system setting data in EEPROM is lost, the VFD will display "Eeprom data lost". Please press [ **Shift** ] + [ **4** ] and [ **0** ] to save after setting parameters.

## Exception handling

If the electronic load cannot start normally, please check and take measures by reference to steps below.

1. Check whether the power line is correctly connected and confirm whether the electronic load is powered.  
Correct wiring of power line => 2  
Incorrect wiring of power line => Re-connect the power line and check whether the exception is removed.
2. Check whether the power in On. [ **Power** ] key is under "  "(On) status.  
Yes => 3  
No => Please check the [ **Power** ] key to start power and check whether the exception is removed.
3. Check whether the power voltage setting of the electronic load is larger than the power supply voltage. If the power voltage of the load is set to 220V and the supply voltage is 110V, the electronic load will not start.
4. Check whether the fuse of electronic load is burned out.  
If yes, change fuse. Detailed steps:
  - Pull out power line and take out the fuse box at power line jack with a small screw driver. As shown below.

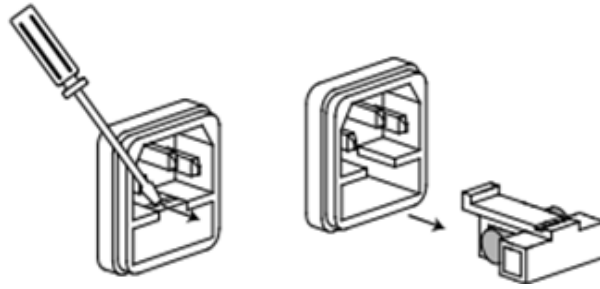

- If the fuse is fused, replace it with a fuse of the same specification according to the model. The fuse and model matching information is shown in the table below.

Model	Fuse specification (220VAC)	Fuse specification (110VAC)
IT8511+	T0.5A 250V	T1.25A 250V
IT8511A+	T0.5A 250V	T1.25A 250V
IT8511B+	T0.5A 250V	T1.25A 250V
IT8512+	T0.5A 250V	T1.25A 250V
IT8512A+	T0.5A 250V	T1.25A 250V
IT8512B+	T0.5A 250V	T1.25A 250V
IT8512C+	T0.5A 250V	T1.25A 250V
IT8512H+	T0.5A 250V	T1.25A 250V
IT8513A+	T1.25A 250V	T2.5A 250V
IT8513B+	T1.25A 250V	T2.5A 250V
IT8513C+	T1.25A 250V	T2.5A 250V
IT8514B+	T1.25A 250V	T2.5A 250V
IT8514C+	T1.25A 250V	T2.5A 250V
IT8516C+	T2.5A 250V	T5A 250V

- After replacement, install the fuse box back to original position, as shown below.

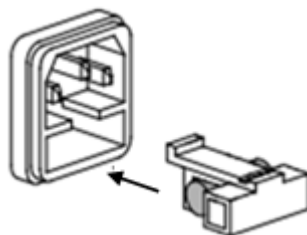

# Chapter3 Functions and Characteristics

This chapter elaborates on the functions and characteristics of electronic loads. Contents following sections:

- Switching of local/remote operation modes
- Constant-status operation mode
- Input On/Off function
- Keyboard locking function
- Short - circuit analog function
- System setup function
- Triggering function
- List mode
- Test function
- Save/Recall
- VON function
- Full protection function: OCP, OVP, OTP, OPP
- Current monitoring function
- Ripple function

## 3.1 Local Mode/Remote Mode

There are two types of control modes for IT8500+ series products: **Local mode** and **Remote mode**.

- Local mode: Use the buttons on the front panel of the electronic load to perform related operations.
- Remote mode: You can operate the electronic loads through PC via communication cable (optional). In remote control mode, the keys on the front panel cannot work except **[Local]** key. Customers could through **[Local]** key to switch the control mode.

## 3.2 Operation Mode

There are four operation modes of IT8500+ series products:

- Constant current mode (CC)
- Constant voltage mode (CV)
- Constant resistance mode (CR)
- Constant power mode (CW)

### 3.2.1 Constant Current Mode (CC)

Select the function key CC, the load enters the constant current mode. In the constant current mode, the electronic load consumes a constant current regardless of whether the input voltage changes. The relationship between voltage and current is shown in the figure below.

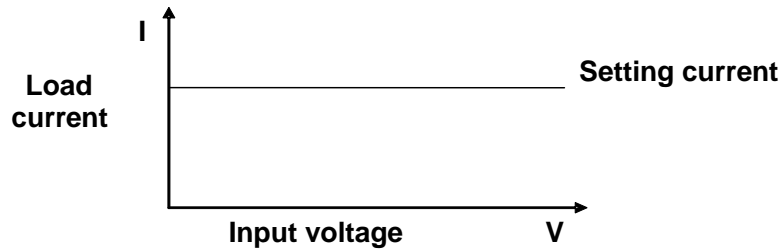

### CC mode

Diagram 3-1 I-V curve in CC mode

There are two ways to set the current value:

- In CC mode, rotate the Rotary knob.
- In CC mode, input value through number keys directly, and press **[Enter]** to confirm.

In CC mode, you can set the maximum operating current value.

### Steps

1. Press **[CC]**, and then press **[Shift]+[CV]**(Setup) to enter into the parameters setting page.

RANGE=30.000A  
CC

2. Set the maximum working current value, and press **[Enter]** to confirm.

RANGE =10.000A  
CC

3. Set the maximum working voltage value, and then press **[Esc]** to exit the setup page.



#### Note

When you set the current range to low range, the resolution of current will increase. Here, you can set only the voltage range, and other parameter settings are used to edit the automatic test steps (described below).

In CC mode, the user can also set the minimum value of the voltage, the rising slope value of the current and the falling slope value of the current.

### 3.2.2 Constant Voltage Mode (CV)

In constant voltage mode, the electronic load will consume enough current to maintain the input voltage at the set voltage.

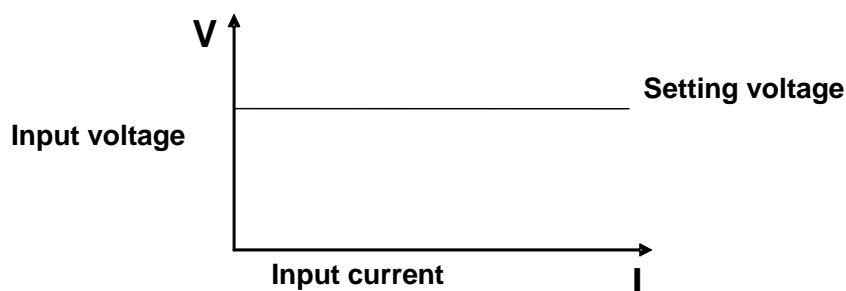

### CV mode

Diagram 3-2 I-V curve in CV mode

There are two ways to change the voltage:

- In CV mode, rotate Rotary knob.
- In CV mode, input value through number keys directly, press **[Enter]** to confirm.

## Steps

1. Press **[CV]**, and then press **[Shift]+[CV]**(Setup) to enter into the parameters setting page.

RANGE=120.00V  
CV

2. Set the maximum working voltage value, and press **[Enter]** to confirm.

RANGE=10.00V  
CV

3. Set the maximum working current value, and then press **[Esc]** to exit the setup page.

HIGH=30.000A  
CV



Note

Here, you can set only the current range, and other parameter settings are used to edit the automatic test steps (described below).

In CV mode, the user can also set the minimum value of the current.

## 3.2.3 Constant Resistance Mode (CR)

In constant resistance mode, the DC load will behave as a fixed resistance value. As shown below, the load linearly changes the current value with the rising of input voltage.

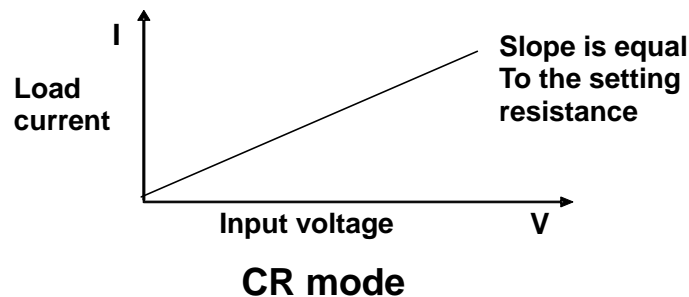

Diagram 3-3 I-V curve in CR mode

There are two ways to set the resistance value:

- In CR mode, rotate Rotary knob.
- In CR mode, input value through number keys directly, press **[Enter]** to confirm.

## Steps

1. Press **[CR]**, and then press **[Shift]+[CV]**(Setup) to enter into the parameters setting page.

RANGE=7500.0Ω  
CR

2. Set the maximum working resistance value, and press **[Enter]** to confirm.

RANGE =2000Ω  
CR

3. Set the maximum working voltage value, and then press **[Esc]** to exit the

setup page.

HIGH=120.0V

CR



Note

In CR mode, the user can also set the minimum value of the voltage.

### 3.2.4 Constant Power Mode (CW)

In constant power mode, the electronic load will consume a constant power, as shown in the figure below, if the input voltage rises, the input current will decrease and the power  $P (= V * I)$  will remain at the setting value.

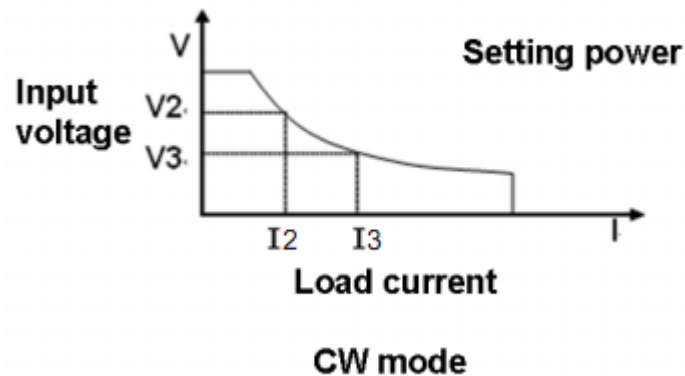

Diagram 3-4 I-V curve in CW mode

There are two ways to set the power value:

- In CW mode, rotate Rotary knob.
- In CW mode, input value through number keys directly, press **[Enter]** to confirm.

#### Steps

1. Press **[CW]**, and then press **[Shift]+[CV]**(Setup) to enter into the parameters setting page.

RANGE=150.00W

CW

2. Set the maximum working resistance value, and press **[Enter]** to confirm.

RANGE =100.00W

CW

3. Set the maximum working voltage value, and then press **[Esc]** to exit the setup page.

HIGH=120.00V

CW



Note

In CW mode, the user can also set the minimum value of the voltage.

## 3.3 Input On/Off Control

**[On/Off]** button on the front panel is used to manually control input on or off.

- **[On/Off]** button lighted indicates the load input is turned on, and the real-time voltage and current information about the current loop is displayed on the VFD screen.



- When the **[On/Off]** button light is off, the lower left of the VFD displays OFF, indicating that the input is turned off.

### 3.4 Key Lock Function

Press the combined keys **[Shift] + [On/Off]** (Lock) to lock the front panel keys, and VFD will display a **Lock** label. In this functional state, all keys except the following keys are invalid. Pressing **[Shift] + [On/Off]** (Lock) again will cancel the lock.

- The **[On/Off]** button is available to toggle the input on and off.
- The combined keys **[Shift]+[7]** (Info) is available to view the instrument information. When viewing the instrument information, press **[Esc]** to exit.

### 3.5 Short-circuit Analog Function

Short circuit simulation and short circuit current measurement: you may press **[Shift] + [1]** (Short) button to emulate a short state. It can be used to check whether the tested instrument's short protection is available.

Press **[Shift] + [1]** (Short) to switch the short circuit condition. The short-circuit operation does not affect the current set value. When you press **[Shift] + [1]** (Short) again, the electronic load returns to the original setting state.

In the short-circuit status, the actual consumed current value depends on the operating mode and current range of the load. In CC, CW and CR modes, when the current is within the maximum range, the short-circuit current is the input current value. When the current exceeds the maximum range, the maximum short-circuit current is 110% of the range. In the CV mode, the short circuit is equivalent to setting the constant voltage value of the load to 0V.

### 3.6 System Menu (System)

Press **[Shift] + [ 8 ]** (system) to enter the system menu.

POWER-ON	<b>POWER-ON</b>	Power on state of instrument
	RST(default)	Do not remember state in SAVE 0. Customer can save an often used data in SAVE 0 to recall when power on the DC load next time.
	SAV0	Remember state in SAVE 0
BUZZER	<b>BUZZER</b>	Buzzer status setting
	ON(default)	Enable audible beep when key is pressed.
	OFF	No sound when key is pressed.
KNOB	<b>KNOB</b>	Real-time update function of knob
	UPDATE(default)	The value modified with knob during operation will be saved after input is off. For example, the DC load is set to 1A by press <b>[CC]</b> and turned on the input. Then increase the setting value to 2A with knob. When customer turn off input, the setting value is still 2A.
	OLD	As explained above, after the input is turned off, the setting value is 1A instead of 2A.
TRIGGER	<b>SOURCE</b>	Set trigger mode
	MANUAL(Def)	Triggered from the <b>[Shift] + [.]</b> key.
	EXTERNAL	Triggered from a TTL high signal at the trigger connector on rear panel
	BUS	Triggered from a serial bus command 5AH
	HOLD	Receiving a command 9DH
MEMORY	<b>MEMORY</b>	Use with the Recall button to call up the stored parameters.
	GROUP= <u>0</u>	<b>0</b> : indicates 1-10 groups;

		1: indicates 11-20 groups, and so on.
DISPLAY	<b>DISP-TIMER</b>	Timer function
	ON	Enable timer function
	OFF(default)	Disable timer function
RS-232	<b>RS-232</b>	
	4800_8N 1	Baud rate 4800, data bit 8, none parity, stop bit 1
	9600_8N 1	Baud rate 9600, data bit 8, none parity, stop bit 1
	19200_8N 1	Baud rate 19200, data bit 8, none parity, stop bit 1
	38400_8N 1	Baud rate 38400, data bit 8, none parity, stop bit 1
PROTOCOL	SCPI	Select SCPI protocol
	FRAME	Select FRAME protocol
ADDRESS	ADDRESS= <u>0</u>	Set the instrument's address(0~31)
RUNMODE	<b>RUN</b>	Running mode at power on
	NORMAL	Normal mode
	BATTERY	Default in battery test mode at power on
	PROG_TEST	Default in automatic test mode at power on
	OCP_TEST	Default in OCP test mode at power on
	OPP_TEST	Default in OPP test mode at power on
TESTMOD	<b>TESTMODE</b>	Automatic test editing mode
	NEW	IT8500+ specialized automatic test editing mode
	IT8500	Compatible with IT8500 Automatic Test Edit Mode
DEFAULT	<b>DEFAULT</b>	Factory default setting
	NO	Do not return instrument to factory default settings.
	YES	Return instrument to factory default settings.

## > DEFAULT

This option is used to restore all settings in the system menu to factory setting values. Select "YES" and press **[Enter]** to restore to factory setting values. Otherwise, the original system menu settings will remain unchanged.

The factory system menu is as follows:

Power-on	Rst
Buzzer	On
Knob	Update(default)
Trigger	Manual
Memory	Group=0
Displ	Off (default)

## >Power-on

When the power-on parameter is selected as **RST**, the input state when the load is powered on is the factory state. If **SAVO** is selected, the input state at power-on of the load is the value of SAVE 0.

## >Trigger

When using the transient and list function, you need to use the electronic load

trigger function, you can choose Manual, External, Hold, or Bus as the trigger mode. For the Manual option, the trigger signal is provided by composite keys **[Shift]+ [.]**(Trigger) in front panel.

### >Buzzer

This item can set the key sound state. If in On mode, the electronic load will issue beeper sound when you press any button. If in Off mode, the beeper will not make a sound. The default set is in on mode.

### >Knob

- When the load input is turned on and the knob is turned to change the set value, if the UPDATE option is selected, the load value is still the current value after the load input is turned off;
- If the OLD option is selected, the set value returns to the original value after the load input is turned off.

### >Display

- If the option is set to On, the display of time 0.0000S will appear on the left side of the VFD. Turn on the load input, the load time recording is started; turned off the load input, the recording is stopped.
- If the option is set to Off, the load time is not recorded.

## 3.7 Config Menu (Config)

Press **[Shift]+ [ 9 ]** (Config) to enter the configuration menu.

PROTECT	<b>Max-P</b>	Set hardware power protection
	MAX POWER=150.00W	Set hardware OPP value
	<b>A-LIMIT</b>	Set software current protecting state
	ON	Enable software OCP function
	A-LIM POIN=30.00 <u>0</u> A	Set the software OCP level
	A-LIM DELAY=3 <u>S</u>	Set the OCP delay time
	OFF	Disable the software OCP function
	<b>P- LIMIT</b>	Set software power protecting state.
	P-LIM POIN=150.00 <u>W</u>	Set the software OPP level.
	P-LIM DELAY=3 <u>S</u>	Set the OPP delay time.
	<b>TIMER</b>	Set load on timer
	ON	Enable load-on timer
	LOAD-TIMER=10.0S	Set the load-on duration (0.1S~9999.9S)
	OFF	Disable load-on timer
MEASURE	<b>V-RANGE</b>	Voltage range automatic switching function
	ON	Enable voltage auto range function
	OFF	Disable voltage auto range function
	<b>FILTER</b>	Set the filter parameter
	FILTER COUNT = 2^14	Filter count set, ranges from 2 to 16.

	<b>TIME-V1</b>	
	TIME-VOLT1=0.000V	Set the start time to measure the voltage rise/fall time.
	<b>TIME-V2</b>	
	TIME-VOLT2=120.00V	Set the end time to measure the voltage rise/fall time.
SENSE	<b>REM- SENSE</b>	Remote sense function
	ON	Enable remote sense function
	OFF	Disable remote sense function
VON	<b>VON</b>	Set the load's VON point. For details, see 3.12 <b>VON Function</b> .
	LIVING	VON point living state
	VON POINT = 0.10V	Set the VON value
	LATCH	VON point latch state
	VON POINT = 0.10V	Set the VON value
RESET	<b>RESET</b>	Reset the configuration menu.
	NO	Do not reset the configuration menu.
	YES	Reset the configuration menu.

### >FILTER

This menu can set the number of sampled data during filtering. The average value of the sampled data is taken during filtering. The setting range is 2~16.

### >V-RANGE

This menu is used to control whether the voltage measurement range is changed automatically.

- On: Indicates the voltage measurement range will automatically change between the high range and the low range.
- Off: Indicates the voltage measurement range will not automatically change.

### >RESET

This option is used to restore all settings in the CONFIG MENU to factory setting values. Select "YES" and press **[Enter]** to restore to factory setting values. Otherwise, the original CONFIG MENU settings will remain unchanged.

## 3.8 Trigger Function

Triggering is used with the transient operation; list operation and auto-test function. There are four types of triggers you can use for IT8500+ products.

**Manual:** An immediate trigger is created by pressing **[Shift]+ [⏏]** (Trigger) on the front panel.

**External (TTL signal):** On the rear panel of the electronic load, TRIG is the trigger input terminal. When the external signal trigger mode is valid, after the low pulse (>10uS) is applied to this terminal, the load will perform a trigger operation. When the external trigger is selected, the positive and negative terminals of TRIG generate the trigger signal, and the low pulse is valid. A trigger-corresponding input can be used to change the set value (voltage, current, resistance, etc.) to toggle between set points in the transient trigger mode, or to generate pulses in the transient pulse mode.

**Bus:** The instrument will be triggered if command 5AH is sent via the communication interface.

**Hold:** The instrument will be triggered if command 9DH is sent via the communication interface.

The steps to select a trigger source are as follows:

## Steps

1. Press **[Shift] + [8]** (system) to enter the system menu.  
POWER-ON BUZZER
2. Press the right key to move to TRIGGER, and press **[Enter]** to enter the trigger source setting page.  
SOURCE MANUAL
3. Select the trigger source and press **[Enter]**.  
MANUAL EXTERNAL BUS HOLD
4. Press **[Esc]** to exit the setting page.

## 3.9 LIST Operation

LIST mode provides an accurate, fast and low-cost way to complete any complicated current change mode, which enables synchronization of internal or external signals in multiple quasi-bit load precision tests.

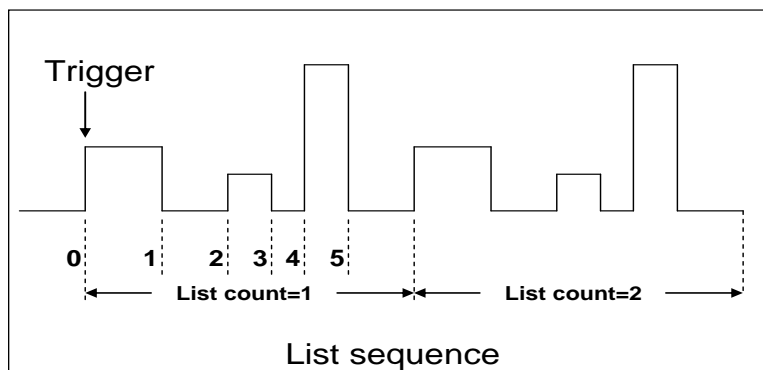

When different trigger sources are selected, the LIST function will form a variety of complex sequences by editing step value, pulse width and slope of each step to meet complicated test requirements. LIST parameters comprise designation of input list file, input step count (2-84 steps at maximum), step time (0.00005s – 3600s) as well as setting value and slope of each step. The number of times the List file is repeatedly executed ranges from 1 to 65535. The list file can be stored in non-volatile RAM available for a quick output in case of usage. The user can edit 7 groups of list files at maximum.

If the load operation mode is at List operation, the load will start List operation when it receives a trigger signal and will stop when it complete or when it receives another trigger signal.



You can press the keys on the front panel of the electronic load to edit the sequence operation files, and trigger this sequence operation. Or you may directly recall existing sequence operation files to trigger the sequence operation. For example, when the DUT output voltage is 10V and the output current is 3A, after editing the sequence operation files under Constant Current (CC) mode, the steps for triggering sequence operation are as follows:

## Operation steps

1. Press **[Shift]+[3]** keys, the interface displayed as follows:  
LIST OFF CALL EDI
2. Operate  key and move to EDI. Press **[Enter]** key.
3. Set the CC range.  
LIST RANGE=3A
4. Edit number of steps. Press **[2]** key to edit two steps. Press **[Enter]** key.  
LIST STEP=2(2-84)
5. Edit current value in step 1 and press **[Enter]** key.  
STEP 01 =1A
6. Edit slope in step 1 and press **[Enter]** key.  
STEP 01 =0.1A/US
7. Edit time in step 1 and press **[Enter]** key.  
STEP 01 =5S
8. Edit current value in step 2 and press **[Enter]** key.  
STEP 02 =2A
9. Edit slope in step 2 and press **[Enter]** key.  
STEP 02 =0.1A/US
10. Edit time in step 2 and press **[Enter]** key.  
STEP 02 =5S
11. Edit repeat count and press **[Enter]** key.  
REAPEAT =3
12. Save the edited file and press **[Enter]** key.  
SAVE LIST =1(1-7)
13. Operate  key and move to OFF. Press **[Enter]** key (In this case, OFF changes to ON, and the VF status indicator Trig lamp of the VFD display is illuminated). Press **[ESC]** key to exit setting.  
LIST OFF CALL EDI
14. Press **[On/Off]** key to open input and press **[Shift] +**  key (Trigger key).
15. Press **[CC]/ [CV]/ [CR]/ [CW]** key or any composite function key to exit List test function.

For direct recall of existing List files and triggering of List operation, refer to steps below:

## Operation steps

1. Press **[Shift] +3** keys.  
LIST OFF CALL EDI  
Ensure that OFF lamp flicks. If not, press **[Enter]** to change the lamp from ON to OFF.
2. Press  key to select CALL. And press **[Enter]** for confirmation.
3. Select edited file and press **[Enter]** for confirmation.  
RECALL LIST = 1

- Operate  key and move to OFF. Press **[Enter]** key (In this case, OFF changes to ON, and the VF status indicator Trig lamp of the VFD display is illuminated). Press **[ESC]** key to exit setting.

LIST OFF CALL EDI

- Press **[On/Off]** key to open input and press **[Shift]** +  key (Trigger key).

L1. 0.0

Trig

## 3.10 Test Function

The transient test allows switching between two different load values. A common application is to test the dynamic characteristics of DC source.

There are three different types of transient operation: **continuous, pulse, toggled**.

Transient test parameters include:

- Transient test mode
- Transiently switched A and B values
- Pulse width time (In PULSE mode)
- Frequency
- Duty cycle
- Current rise and fall slope (CC mode specific parameters)

### 3.10.1 Transient Test Function

#### Continuous Mode

In continuous transient operation, the load is continuously switched between two load values. An example is shown in the following figure:

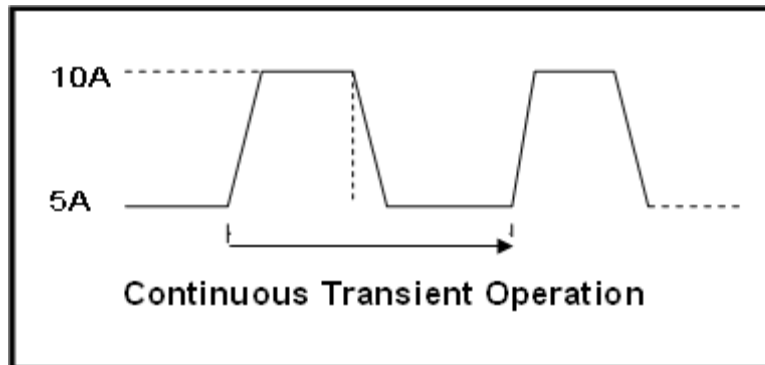

Take CC mode as an example (other modes operate similarly). When the measured instrument output voltage is 10V, current is 3A, and load current is switched between 1A and 2A, the transient test parameters and steps are set as follows:

- Press **[Shift]+[2]** (Tran), move  key to select **ON**, press **[Enter]** to confirm.

TRAN ON OFF

- Press  to select transient operation mode as **CONTINUOUS** (the indicator lamp Trig will be lighted).

MODE CONTINUOUS

PULSE TOGGLE

3. Set the rising slope, press **[Enter]** to confirm.  
UP=1A/uS
4. Set the descending slope, press **[Enter]** to confirm.  
DOWN=1A/uS
5. Set level **A**, press **[Enter]** to confirm.  
LEVEL A=1A
6. Set level **B**, press **[Enter]** to confirm.  
LEVEL B=2A
7. Set the frequency, press **[Enter]** to confirm.  
FREQ=50HZ
8. Set the duty factor, press **[Enter]** to confirm.  
DUTY=98%(0.1%-99.9%)
9. Open the transient test function, maintain on the “on” selection, press **[Enter]** to confirm.  
TRAN    ON    OFF
10. Then the VFD will display TRAN and Trig.  
10.0000V  0.0000A  
0.00W    TRAN.    0  
                  Trig
11. Press **[On/Off]** to turn on the input function, and press **[Shift]+[⊙]** (Trigger) to trigger.

It can be seen that the A/B value is continuously switched, and the number of running times is visible in the lower right corner.

#### **Note**

The maximum number of running times is 65535 and then reset to zero. The running times reset does not affect the execution of the transient test.

12. Press any key of CC/CV/CR/CW or other composite function keys to exit the transient test function. If you need to continue transient test parameter setting and perform transient test, repeat steps 1 to 11.

## Pulse Mode

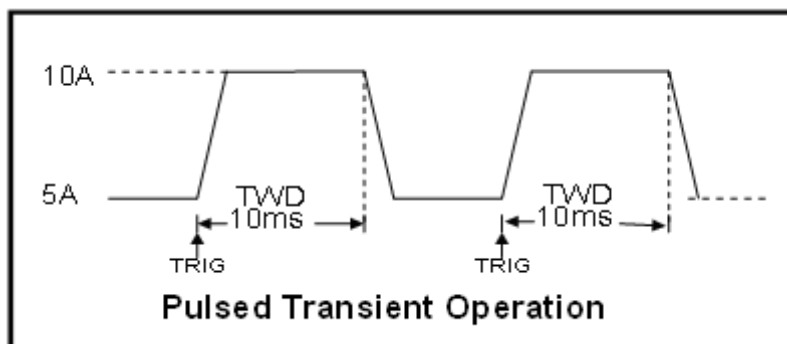

In pulse operation, the load operates at the A value that has been entered until a trigger is received. At the trigger, the load switches to the B value and stays at that level for the B timing value. Then the load switches back to the A value and stays there until another trigger is received.



Take CC mode as an example (other modes operate similarly). When the



measured instrument output voltage is 10V, current is 3A, and load current is switched between 1A and 2A, the transient test parameters and steps are set as follows:



1. Press **[Shift]+[2]** (Tran), move  key to select **ON**, press **[Enter]** to confirm.  
TRAN    ON    OFF
2. Press  to select transient operation mode as **PULSE** (the indicator lamp Trig will be lighted).
3. Set the rising slope, press **[Enter]** to confirm.
4. Set the descending slope, press **[Enter]** to confirm.
5. Set level **A**, press **[Enter]** to confirm.
6. Set level **B**, press **[Enter]** to confirm.
7. Set the **WIDTH**, press **[Enter]** to confirm.
8. Open the transient test function, maintain on the “on” selection, press **[Enter]** to confirm.
9. Then the VFD will display TRAN and Trig.
10. Press **[On/Off]** to turn on the input function, and press **[Shift]+[ (Trigger) to trigger.**
11. Press any key of CC/CV/CR/CW or other composite function keys to exit the transient test function. If you need to continue transient test parameter setting and perform transient test, repeat steps 1 to 10.

## Toggled Mode

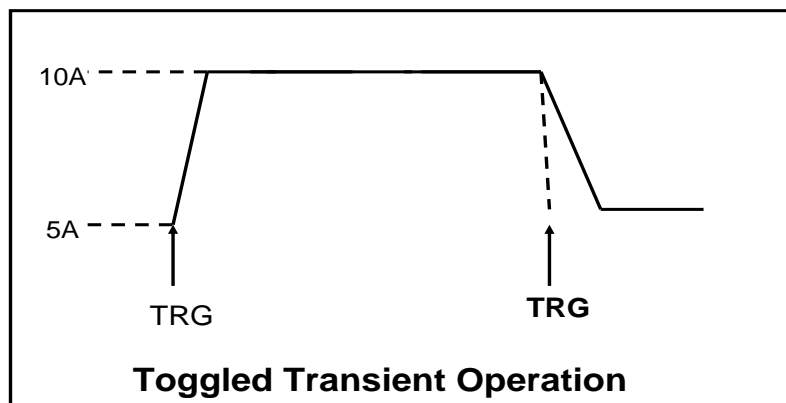
In toggled transient operation, the load starts at the stored parameters for the mode. When a trigger is received, the load switches to B value. When another trigger is received, the load switches to the A level. It stays at the A value until another trigger is received, at which point it switches to the B value. Here's an example:



Take CC mode as an example (other modes operate similarly). When the measured instrument output voltage is 10V, current is 3A, and load current is switched between 1A and 2A, the transient test parameters and steps are set as follows:

1. Press **[Shift]+[2]** (Tran), move  key to select **ON**, press **[Enter]** to confirm.  
TRAN    ON    OFF
2. Press  to select transient operation mode as **TOGGLE** (the indicator lamp Trig will be lighted).

3. Set the rising slope, press **[Enter]** to confirm.
4. Set the descending slope, press **[Enter]** to confirm.
5. Set level **A**, press **[Enter]** to confirm.
6. Set level **B**, press **[Enter]** to confirm.
7. Open the transient test function, maintain on the “on” selection, press **[Enter]** to confirm.
8. Then the VFD will display TRAN and Trig.
9. Press **[On/Off]** to turn on the input function, and press **[Shift]+[⊙]** (Trigger) to trigger.
10. Press any key of CC/CV/CR/CW or other composite function keys to exit the transient test function. If you need to continue transient test parameter setting and perform transient test, repeat steps 1 to 9.

### 3.10.2 OCP Test Function

IT8500+ series electronic load supports the over current protection (OCP) test function. In the OCP mode, when input voltage reaches VON point, the DC load start to draw a current from the source after a delay time. The current value will increase by a certain step size at regular intervals. Simultaneously, the DC load will judge whether the input voltage exceeds OCP voltage you've set. If it is, indicates that the OCP has not occurred, then repeat the current stepping operation until the cutoff current is reached; if not, it indicates that the OCP has occurred, and then check whether the current value is within the target range. If it is within the range, PASS, otherwise FAULT. In other words, there are two conditions for the end of the OCP current step, and if anyone is satisfied, the stepping operation of the current will be ended.

- Reach the set cutoff current.
- The measured power supply voltage is less than the OCP voltage setting value.

Press **[Shift]+ [CC]** (OCP) to enter the OCP operation page, and the related parameters are described as follows.

No.	Parameter	Description
1	VON LEVEL=0.000V	Set the Von voltage value.
2	VON DELAY=0.00S	Set the Von voltage delay time. After delay certain time, the DC load starts to draw current.
3	RANGE=3.000A	Set the working current range.
4	START=0.1000A	Set the initial current.
5	STEP=0.1000A	Set the step current.
6	STEP DEL=0.20S	Set delay time of each step.
7	END=2.0000A	Set the cutoff current.
8	OCP VOLT=2.000V	Set the OCP voltage.
9	MAX TRIP =1.5000A	Upper limit of OCP value.
10	MIN TRIP=0.9000A	Lower limit of OCP value
11	SAVE OCP FILE=1	Save OCP test file (1-10)

Set the power on mode to the OCP test mode:

1. Press **[Shift]+ [8]** (system) to enter into system menu  
0.0000V 0.000A  
POWER-ON BUZZER
2. Press right key, select **RUNMODE** and confirm with **[Enter]** button.  
0.0000V 0.000A  
RUN NORMAL
3. Press  to select **OCP\_TEST**, press **[Enter]** to confirm.  
The VFD displays the OCP test page.  
0.0000V 0.000A  
STOP 0.000A
4. After above steps, press **[.]** (Trigger) button to run **OCP\_TEST** file.

 **Note**

To exit the OCP mode, you can press the **[Shift]+ [8]** (System) buttons to enter the system menu and set the **RUNMODE** to **NORMAL**.

### 3.10.3 OPP Test Function

IT8500+ series electronic load supports the over power protection (OPP) test function. In the OPP mode, when input voltage reaches VON point, the DC load start to draw a power from the source after a delay time. The power value will increase by a certain step size at regular intervals. Simultaneously, the DC load will judge whether the input voltage exceeds OPP voltage you've set. If it is, indicates that the OPP has not occurred, then repeat the power stepping operation until the cutoff power is reached; if not, it indicates that the OPP has occurred, and then check whether the power value is within the target range. If it is within the range, PASS, otherwise FAULT. In other words, there are two conditions for the end of the OPP power step, and if anyone is satisfied, the stepping operation of the power will be ended.

- Reach the set cutoff power.
- The measured power supply voltage is less than the OPP voltage setting value.

Press **[Shift]+ [CW]** (OPP) to enter the OPP operation page, and the related parameters are described as follows.

No.	Parameter	Description
1	VON LEVEL=0.000V	Set the Von voltage value.
2	VON DELAY=0.01S	Set the Von voltage delay time. After delay certain time, the DC load starts to draw power.
3	RANGE=5A	Set the working current range.
4	START =0.1W	Set the initial power.
5	STEP =1W	Set the step power.
6	STEP DEL=1S	Set delay time of each step.
7	END =12W	Set the cutoff power.
8	OPP VOLT=7V	Set the OPP voltage.
9	MAX TRIP =6.5W	Upper limit of OPP value.

10	MIN TRIP =5.6W	Lower limit of OPP value
11	SAVE OPP FILE=1	Save OPP test file (1-10)

Set the power on mode to the OPP test mode:

- Press **[Shift]+ [8]** (system) to enter into system menu  
 0.0000V 0.000A  
 POWER-ON BUZZER
- Press right key, select **RUNMODE** and confirm with **[Enter]** button.  
 0.0000V 0.000A  
 RUN NORMAL
- Press  to select **OPP\_TEST**, press **[Enter]** to confirm.  
 The VFD displays the OPP test page.  
 0.0000V 0.000A  
 STOP 0.00W
- After above steps, press **[.]** (Trigger) button to run **OPP\_TEST** file.

#### Note

To exit the OPP mode, you can press the **[Shift]+ [8]** (System) buttons to enter the system menu and set the **RUNMODE** to **NORMAL**.

### 3.10.4 Battery Discharge Test

IT8500+ series electronic load supports the discharge test function of the battery in CC/CW/CR mode.

The test mode should be set first, and then the discharge stop conditions. There are three discharge stop conditions to be set for IT8500+ series products, which are **STOP VOLT**, **STOP CAP**, and **STOP TIMER**. When any of the three conditions is satisfied, the discharge is stopped and the electronic load is automatically switched to the OFF state.

When user only need to do battery testing in one or two stop conditions, the other conditions should be set to the specified value (STOP VOLT:0V; STOP CAP:999.999AH; STOP TIMER:99999S).

For example, if the stop voltage is used as the termination condition and the stop voltage is set, the stop capacity and the stop time must be set to the maximum value (STOP CAP = 999.999AH, STOP TIMER=99999S).

When the system checks the discharging time or battery voltage or capacity is equal to the setting stop value or under an insecurity state, the battery test will be interrupted. The battery voltage, discharge time and discharged capability are displayed on the VFD while testing.

#### Battery Test Data Storage

Before programming the battery test parameters, select RUNMODE as NORMAL.

The following describes the operation steps by taking a discharge current of 7 A, a cutoff voltage of 35 V, and a cutoff capacity of 11 AH as an example.

- Press **[Shift]+ [5]** (Battery), set current range, and then press **[Enter]**.  
 0.0000V 0.000A  
 RANGE =30.000A

2. Set the discharge current, and press **[Enter]**.  
 0.0000V 0.000A  
 CURRENT= 7.000A
3. Set the discharge stop voltage, and press **[Enter]**.  
 0.0000V 0.000A  
 STOP VOLT= 35.00V
4. Set the discharge stop capability, and press **[Enter]**.  
 0.0000V 0.000A  
 STOP CAP= 11.000AH
5. Set the discharge time, and press **[Enter]**.  
 0.0000V 0.000A  
 STOP TIMER= 99999S
6. Save the battery test to specified file (1 – 10). After the file number is set, press **[Enter]**.  
 0.0000V 0.000A  
 SAVE BATT FILE 2

Set the power on state to the battery test. The steps are as follows.

1. Press **[Shift]+ [8]** (system) to enter into system menu.  
 0.0000V 0.000A  
 POWER-ON BUZZER
2. Press right key, select **RUNMODE** and confirm with **[Enter]** button.  
 0.0000V 0.000A  
 RUN NORMAL
3. Press  to select **BATTERY**, press **[Enter]** to confirm.  
 The VFD displays the battery test page.  
 0.0000V 0.000A  
 OS 0.000AH
4. After above steps, press **[.]** (Trigger) button to run **BATT\_TEST** file.  
 The discharging process will be terminated automatically when stop conditions are reached.

#### Note

To exit the **BATTERY** mode, you can press the **[Shift]+ [8]** (System) buttons to enter the system menu and set the **RUNMODE** to **NORMAL**.

## Battery Test Data Recalling

Applicable to IT8511B+/IT8512+/IT8512B+/IT8512C+/IT8512H+/IT8514C+ models. The steps are as follows:

1. In the **BATTERY** mode, press **[Shift]+ [Enter]** (Recall).  
 0.0000V 0.000A  
 RECALL BATTERY 1
2. Press the number keys to select the existing **BATT\_TEST** file and press **[Enter]**.

## Start Battery Test

In the **BATTERY** mode, you can press **[.]** (Trigger) to trigger the running of the battery test. If the load does not detect the battery voltage, or if the stop condition has been satisfied, the test will be stopped immediately and the input of the load will be in OFF state.

During normal testing, the test time, the discharged capacity will be displayed on the VFD in real time.

During the running of the battery test, the front panel can be locked to avoid misoperation and interrupt the test process. If you need to lock the panel, press **[Shift]+[On/Off]** (Lock) to lock all other keys except **[Shift]+[On/Off]** (Lock) itself.

## Stop Battery Test

Press **[.]**(Trigger) or **[Shift]+[.]** (Trigger) or **[ESC]** to stop battery discharge test (load input OFF).

## Exit Battery Test

To exit the **BATTERY** mode, you can press the **[Shift]+ [8]** (System) buttons to enter the system menu and set the **RUNMODE** to **NORMAL**.

## 3.10.5 CR-LED Test Function

With adding of diode break-over voltage setting in the IT8500+ series electronic load under conventional CR mode, the electronic load only works when voltage applied at its both ends is higher than the diode break-over voltage to give a real simulation of diode working principle, i.e., the ripple current at real LED test.

The I-V curve of LED is as shown below. Under conventional CR mode, the electronic load only simulates the static working point of diode as shown in the red circle of the following figure. It is unable to verify the dynamic characteristics of LED under normal working conditions, and the status of accurate ripple current.

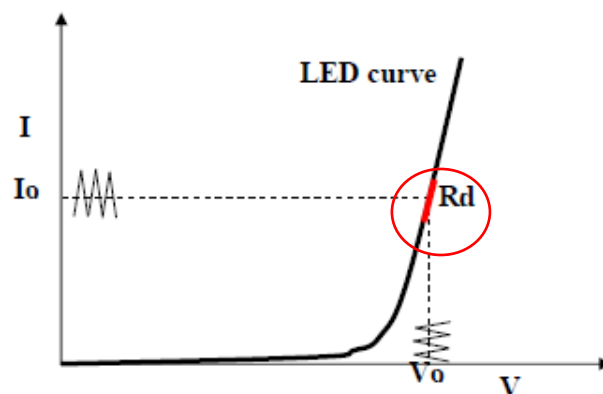

## Calculation method of $V_d$ and R:

Definition:

- $V_o$ : constant working voltage of load LED of LED constant current source;
- $I_o$ : output current of LED constant current source;
- $V_d$ : break-over voltage of diode (string);
- R: constant resistance.

V-I curve of LED is as shown below.

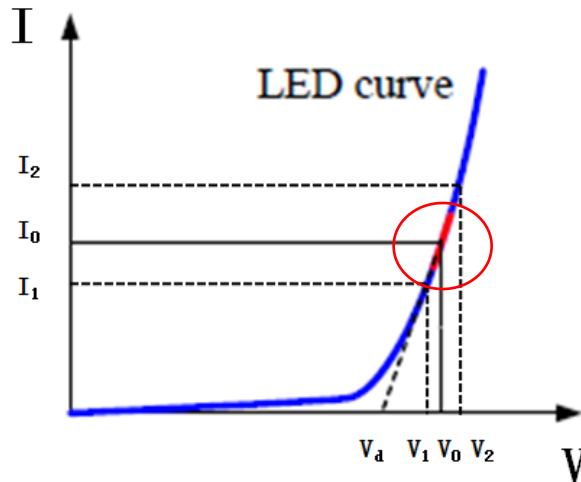

According to four parameters above and the V-I curve of LED, you can calculate the value of R and Vd.

$$R = \frac{V_2 - V_1}{I_2 - I_1}$$

$$V_d = V_0 - (I_0 \times R)$$



**NOTE**

The value of V2, V1, I2 and I1 should be close to the static working point of LED as shown in the red circle above.

Or you can roughly calculate the value of R and Vd with the following equation.

$$V_d = V \times 0.8 \quad R = 0.2V/I$$

Where:

- V: constant working voltage of load LED of LED constant current source;
- I: output current of LED constant current source;
- Vd: break-over voltage of diode (string);
- R: constant resistance.

In the following example, the output voltage of LED driver is 50V, verify that whether the output current of LED is rated current 200mA:  $V_d = 50V \times 0.8 = 40V$   
 $R = (0.2 \times 50V) / 0.2A = 50\Omega$ .

## Setting CR-LED Mode

**Example:** LED driver specification

The output current is 200mA and the range of output voltage is from 45V to 62V.

### Operating steps:



1. **Start CR-LED function and set the Vd value.**
  - 1) Press **[Shift] + [CR]** keys to enter configuration menu.
  - 2) Press Right Key and select **ON**. Press **[Enter]** key to set the Vd value. (Set Vd=40V).  
Select **OFF** to disable CR-LED function, and then press **[Enter]** to exit the setting menu.
  - 3) Press the **[Enter]** key to save the settings.
2. **Set CR mode**
  - 1) Press **[CR]** key and set corresponding constant resistance. (Set CR=50Ω)
  - 2) Press the **[Enter]** key to save the settings.
3. **Press [On/Off] key to turn on load input.**

### 3.10.6 Measurement of Voltage Rise Time

The IT8500+ series electronic load is provided with special voltage rise/drop time measurement function. This function gives a simple analog of voltage rise/drop speed of oscilloscope test power.

Operation methods:

#### Set initial Voltage and Final Voltage

1. Press **[Shift] + [9]** keys to enter configuration menu. Press Right key. Select **Measure** and press **[Enter]** key.
2. Press  to select **TIMEV1**. Press **[Enter]** key. Press numeric keys to set initial voltage value and press **[Enter]** key.
3. Press  to select **TIMEV2**. Press **[Enter]** key. Press numeric keys to set final voltage value and press **[Enter]** key.
4. Press **[ESC]** to exit setting.

#### Start timer function

5. Press **[Shift] + [8]** keys to enter system menu. Press Right key till "DISPLAY" flicks and press **[Enter]** key.
6. Press  key to select "On". Start timer function and press **[Enter]** key.
7. Press **[ESC]** to exit setting.
8. VFD second line will display time 0.0000S.

0.0001V	0.0002A
0.0000S	I= 0.000A
OFF CC	

#### Measurement of Rise Time

9. Connect DC power to be tested to the input terminal of the electronic load. The power is set with a value that is higher than the set final voltage value. Keep power output in OFF status.
10. Set a constant current value on the load and open the load input.
11. Open the power output.
12. The electronic load timer starts timing. After ending, time will keep stable, which is rise time of voltage.
13. Turn off the power output. The electronic load VFD will display voltage drop time.

## 3.11 Saving and Recalling Settings

We can save some often-used parameters in the non-volatile memory, including working mode, voltage/current value and so on. IT8500plus series provide 100 non-volatile registers.

They are divided into 10 Memory groups: Group0-9. You can set it in the system menu.

- Group0 means you can save and recall parameters in 0-10 registers.
- Group1 means you can save and recall parameters in 11-20 registers.
- Group2-Group9 can be concluded in the same manner.



## Save and Recall operation

For example: the instrument works in CC mode, setting value is 1A, memory Group is 7. Save "CC 1A" in the 76th register and then recall.

- **Save**

1. Set the parameters ok (CC 1A), and press **[Enter]**.
2. Press **[Shift] + [4]** (Save) to save the instrument's settings to a register.
3. Enter number **[7]** and **[6]**, indicates the settings is saved in the 6th register in Group7.
4. Press **[Enter]**, the setting is saved.

- **Recall**

1. Press **[Shift] + [8]** (System) to enter the system setting page.
2. Press the right key to select **MEMORY**, and press **[Enter]**.
3. Set the value of Group to 7, the interface displayed as follows.  
MEMORY GROUP = 7
4. Press **[Enter]** to confirm the setting.
5. Press **[Shift] + [Enter]** (Recall) to execute the data recalling operation.

At this point, the **[Enter]** key light is on.

6. Enter number **[6]**, indicates the data saved in the 6th register in Group7 is recalled.

## 3.12 VON Function

When testing some power supply products with a slower voltage rise, if the input of the electronic load is turned on first, and then the power is turned on, the power supply may enter the protected state. Therefore, the user can set the VON value, and when the power supply voltage is higher than this value, the electronic load starts to load.

CAUTION

Please confirm whether you need to set the VON voltage. The VON voltage is set to facilitate the user to limit the working voltage, and if you do not need to set the VON voltage, do not set this value, otherwise it may result in unloading.

You can press **[Shift]+[9]** (Config) to enter the configuration menu to set the VON voltage to control the ON/OFF state of the electronic load. The load has two performance modes, Living and Latch. When Living is selected, it indicates that the load works in following state; when Latch is selected, it indicates that the load works in the load latched state.

If your instrument can not work normally, for example, set CC=1A, after turn on the input while the current is still 0A instead of setting value 1A, then you should check VON set firstly. If VON set is not 0V, then please modify to 0V. If the minimum voltage supported by the instrument is not 0V, the setting menu will be automatically set to the minimum value after pressing 0.

- **VON LIVING MODE**

In Living mode, when power is applied to the DC load, the voltage must rise above VON setting before the load draws current from the source. If the voltage below VON setting on the load's terminals, the load will turn off input.

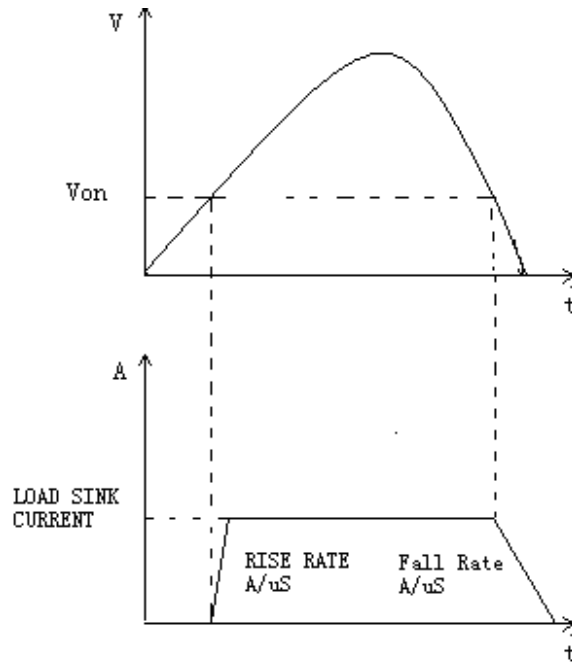

- **VON LATCH MODE**

In Latch mode, as before, the load will turn on only when the voltage exceeds VON setting, but once on, it will now stay on, even if the voltage drops to zero.

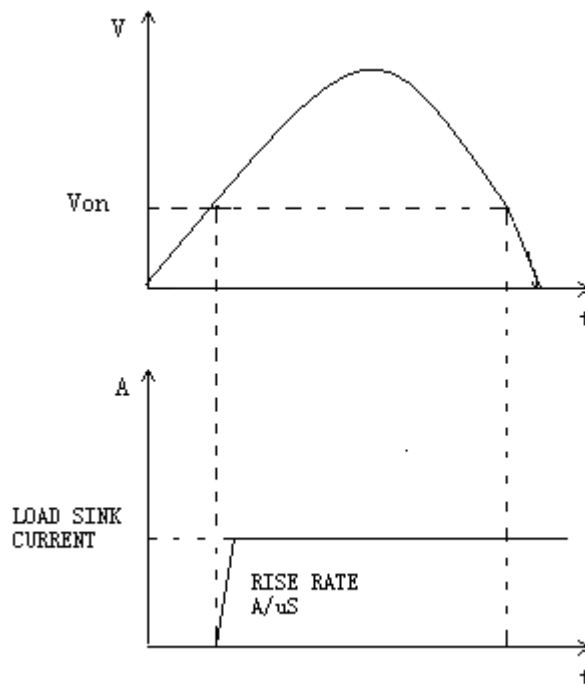

### 3.13 Protection Function

IT8500+ series electronic load supports the following protection function:

- Over voltage protection (OVP)
- Over current protection (OCP)
- Over power protection (OPP)
- Over temperature protection (OTP)

If any of the above protections are activated, the electronic load enters the corresponding self-protection mode, such as over temperature protection, the load will generate an alarm and the input will automatically switch to the OFF state. The VFD will display the OTP. You can clear the protection by pressing any button on the front panel.

### Over voltage protection (OVP)

If input voltage exceeds the voltage limit set by the user, the DC load will turn the input OFF and the buzzer will sound. The display will show OVP.

Press any key on the front panel to exits OVP protection state.

### Over current protection (OCP)

The DC load includes both hardware and software over current protection features.

- **Hardware OCP:** Maximum input current of the DC load will be limited at about 110% of the current range, once the hardware OCP is activated, the status register's OC bit will be set; when the hardware OCP is removed, the status register's OC bit will be reset. Hardware over current protection will not change the DC load's On/Off state.
- **Software OCP:** When the software OCP function is turned on, if the load current exceeds the OCP set value and continues to exceed the set delay time, the load will automatically turn OFF and the VFD will display OCP. At the same time, the OC and PS bits in the status register will be set and they will remain until they are reset. For related configuration items and descriptions, see **3.7 Config Menu (Config)**.

### Over power protection (OPP)

The DC load includes both hardware and software over power protection features.

- **Hardware OPP:** You can set the hardware OPP value of the load. The load will be limited by the hardware to the power value. Hardware OPP does not change the DC load's On/Off state.
- **Software OPP:** You can also set the software OPP value of the load.

For related configuration items and descriptions, see **3.7 Config Menu (Config)**.

### Over temperature protection (OTP)

When the electronic load internal power device temperature exceeds about 85°C, the electronic load activates the temperature protection mode. At this time, the load input will be automatically turned OFF, and the VFD will display the OTP. At the same time, the OT and PS bits in the status register will be set and they will remain until they are reset.

## 3.14 Current Monitoring (I Monitor)

⊙ Current monitoring terminal will output 0-10V analog signal to corresponding to 0 to full range of input current. You can connect an external voltmeter or an oscilloscope to display the input current's changing.

## 3.15 Ripple Function

IT8500+ series DC electronic loads have test ripple function. In the main interface by pressing the up and down keys, you can read the VPK, APK value

in the place where shows the power value. You can read ripple voltage and ripple current by sending instructions also. See in ***IT8500+ programming guide***.

# Chapter4 Automatic Test Function

This chapter introduces the IT8500+ series electronic load automatic test operation method and process.

## 4.1 Introduction

The IT8500+ has two automatic test editing modes. One is the IT8500+ special editing mode, which can save up to 10 groups of test files, and the other is compatible with the IT8500 automatic test editing mode which can save up to 50 groups of test files. The test files in both modes can be recalled and tested at any time. The test is simple and the button can be locked (press **[Shift]+[On/Off]** (Lock)) to prevent accidental touches on the keyboard and affect normal testing.

The electronic load automatically detects the change of the input voltage to determine whether to start the test. After the automatic test start voltage (Start) is set and the DUT is connected, when the load detects that the input voltage rises from 0 to the Start voltage, the automatic test starts running without the external trigger source or a trigger signal provided by manually operation.

### CAUTION

When editing the automatic test mode, please avoid setting the last step to short circuit, and avoid setting the input voltage of the last step to a value less than the Start voltage, otherwise the automatic test will be executed cyclically.

## 4.2 Automatic Test Mode Switching

Press **[Shift]+[8]** (System) to enter the system menu, and press  to select the **TESTMOD** item. The VFD displays **NEW** and **8500**. You can select one of them and press **[Enter]** to confirm.

- **NEW**

This is the automatic test mode for IT8500+ series electronic load.

This mode supports editing 10 groups of test files (file1 – file10), each group contains 10 steps, and 10 groups of test files can be saved in EEPROM. Test files can be linked to each other (such as linking file1 to file2). Each test file contains the following parameters: load mode (CC/CV/CR/CW, current rise and fall slope can be set in CC mode), load value (Value), load time (Ton), unload time (Toff), delay time (Tpf), upper and lower limit of decision value (Low & High), trigger voltage (Start).

- **8500**

This is the automatic test mode compatible with IT8500 series electronic load.

This mode supports storing up to 50 groups of test files (file1-file50). Each group contains 10 steps, and 50 groups of files can be saved in EEPROM. Test files cannot be linked to each other. Each test file contains the following parameters: load mode (CC/CV/CR/CW), load value (Value), delay time (Delay), upper and lower limit value (Min & Max), trigger voltage (Start).

The storage of test files under the two test modes is independent of each other, that is, file1 in two modes is stored in different storage spaces.

Automated testing can be used to program, test, and show whether a test passes or fails, which is very useful for the customer. The automatic test operation consists of four steps: editing, saving, recalling, and running.

## 4.2.1 Test Mode for IT8500+



Note

The “Y” appears in the following edit to indicate the selected state, and press the number key of the corresponding step again to deselect the state.

### Operation Steps

1. Press **[Shift]+[6]** (Prog).  
ACTIVE =0987654321
2. Press the number keys to select the step to be tested, for example, ACTIVE =09876543YY, indicating that you have selected steps 1 and 2 and press **[Enter]** to confirm.
3. In these two steps, if you need to pause in step 2, you can press **[2]**.  
Otherwise, press **[Enter]** directly.  
PAUSE =NNNNNNNNY1
4. In these two steps, if you need the short-circuit test in step 1, you can press **[1]**.  
Otherwise, press **[Enter]** directly.  
SHORT =NNNNNNNN2Y
5. Set **Ton** for the first step, if you want to load on 2S, press **[2]**, and then press **[Enter]** to confirm. Ton ranges from 0 to 60S.  
SEQ01 ON =2S
6. Set **Toff** for the first step, if you want to load off 2S, press **[2]**, and then press **[Enter]** to confirm. Toff ranges from 0 to 60S.  
SEQ01 OFF =2S
7. Set **Tpf** for the first step, if you want to delay 1S, press **[1]**, and then press **[Enter]** to confirm.  
SEQ01 P/F =1S
8. Set **Ton** for the second step, if you want to load on 2S, press **[2]**, and then press **[Enter]** to confirm. Ton ranges from 0 to 60S.  
SEQ02 ON =2S
9. Set **Toff** for the second step, if you want to load off 2S, press **[2]**, and then press **[Enter]** to confirm. Toff ranges from 0 to 60S.  
SEQ02 OFF =2S
10. Set **Tpf** for the second step, if you want to delay 1S, press **[1]**, and then press **[Enter]** to confirm.  
SEQ02 P/F =1S
11. Set the load voltage value and set it to 0 if not needed.  
AUTO START= 0.500V

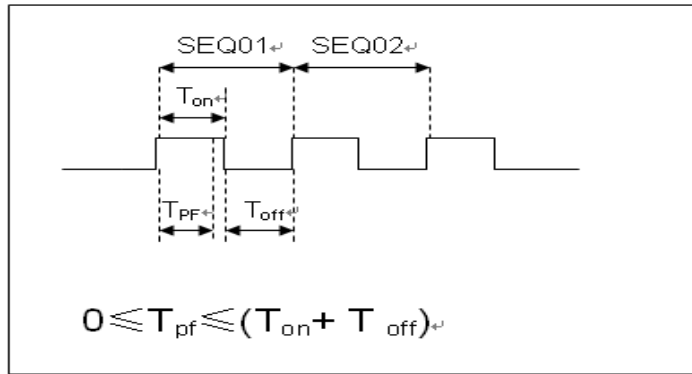

T<sub>pf</sub> is the delay time for a step.

12. Set stop conditions: **COMP** means stop test when all the steps are completed, **FAILURE** means stop test when the testing fails. Press **[Enter]** key to confirm.

STOP COMP FAILURE

13. Select the test file to link if you'd like to. The linked file must be saved before. 0 stands for not linking to other files. Press **[Enter]** key to confirm.

CHAIN PROGRAM=0 (0-10)

### Automatic test file and single step storage correspondence table

PROGRAM Sequence	1	2	3	4	5	6	7	8	9	10
Save Group	1	2	3	4	5	6	7	8	9	10
PROGRAM Sequence	2	2	3	4	5	6	7	8	9	10
Save Group	11	12	13	14	15	16	17	18	19	20
:										
:										
PROGRAM Sequence	10	2	3	4	5	6	7	8	9	10
Save Group	91	92	93	94	95	96	97	98	99	100

14. Save the edited files in EEPROM, you can save up to 10 groups of files, e.g. please press **[1]** to save the edited file in group 1, and then press **[Enter]** to confirm.

SAVE PROGRAM =1 (1-10)

The above is the automatic test structure. The automatic test single step specific settings also need to be edited separately, so the design is to facilitate the modification of the single step settings.

10.0000V 0.0000A  
0.00W I=1.000A

15. Select an operation mode and then press **[Shift]+[CV]** (Setup) to set related parameters.
16. Edit the automatic test single step, details refer to below procedure. After all the steps are set, press **[Shift]+[4]** (save) to save.

### Set the steps of a test file in the example

In the above step 16, assume that the first step is edited to CC mode, current 2A, the upper limit voltage value is 10V, the lower limit voltage value is 2V; the second step is edited to CV mode, voltage 3V, upper limit current value 5A, lower limit current value 0A. Save in the automatic test file 2.

The first step: CC mode, current 2A, the upper limit voltage value is 10V, and the lower limit voltage value is 2V.

1. Press **[CC]**, set the current to 2A, and then press **[Shift]+[CV]** (Setup) to enter the setting interface.

**RANGE=30.000A**  
**CC**

2. Set the maximum working current, and press **[Enter]** to confirm.

**RANGE =2.000A**  
**CC**

3. Set the upper limit of voltage, press **[Enter]** to confirm.

**HIGH=10.00V**  
**CC**

4. Set the lower limit of voltage, press **[Enter]** to confirm.

**LOW=2.000V**  
**CC**

5. Set the rising slope of current, press **[Enter]** to confirm.

**UP=1A/uS**  
**CC**

6. Set the descending slope of current, press **[Enter]** to confirm.

**DOWN=1A/uS**  
**CC**

The parameter settings are complete.

**10.0000V 0.000A**  
**0.00W I=2.000A**

7. Press **[Shift] + [4]** (Save) to enter the save settings interface. Press numeric key **[1]** twice to save the current step as the first step of **Program 2**.

**SAVE 11**

The second step: CV mode, voltage 3V, the upper limit current value is 5A, and the lower limit current value is 0A.

1. Press **[CV]**, set the voltage to 3V, and then press **[Shift]+[CV]** (Setup) to enter the setting interface.

**RANGE=120.00V**

2. Set the maximum working voltage, take 3V as example, and press **[Enter]** to confirm.

**RANGE=3.00V**

3. Set the upper limit of current, press **[Enter]** to confirm.

**HIGH=5.000A**

4. Set the lower limit of current, press **[Enter]** to confirm.

**LOW=0.0000A**

The parameter settings are complete.

**10.0000V 0.000A**  
**0.00W V=3V**

5. Press **[Shift] + [4]** (Save) to enter the save settings interface. Press numeric keys **[1]** and **[2]** to save the current step as the second step of **Program 2**.



**SAVE 12**

**Note**

The single-step parameter storage position is related to the number of automatic test file storage group and the number of steps. If it is saved in the first group, the single-step parameter storage position is consistent with the number of steps. If it is saved in the second group, the single-step parameter storage position is 1 merges the number of steps, for example, the single-step 1, 2, and 3 are stored in 11, 12, and 13 respectively; if they are stored in the third group, the single-step parameter storage position is 2 merges the number of steps, for example, the single-step 1, 2, and 3 are saved in 21, 22, and 23, and so on.

## Set the steps in CR/CW mode

Set the automatic test step in CW mode:

1. Press **[CW]**, set the power value, and then press **[Shift]+[CV]** (Setup) to enter the setting interface.

**RANGE=150.00W**

2. Set the maximum working power, and press **[Enter]** to confirm.

**RANGE =20.00W**

3. Set the upper limit of voltage, press **[Enter]** to confirm.

**HIGH=120.00V**

4. Set the lower limit of voltage, press **[Enter]** to confirm.

**LOW=0.000V**

5. The parameter settings are complete.

**10.0000V 0.000A**

**0.00W W=1.00W**

Set the automatic test step in CR mode:

1. Press **[CR]**, set the resistance value, and then press **[Shift]+[CV]** (Setup) to enter the setting interface.

**RANGE=7500.0Ω**

2. Set the maximum working resistance, and press **[Enter]** to confirm.

**RANGE =2000Ω**

3. Set the upper limit of voltage, press **[Enter]** to confirm.

**HIGH=120.00V**

4. Set the lower limit of voltage, press **[Enter]** to confirm.

**LOW=0.000V**

5. The parameter settings are complete.

**10.0000V 0.000A**

**0.00W R=2.000Ω**

## 4.2.2 Test Mode for IT8500

1. Press **[Shift] + [6]** (Prog) to set the maximum current value and press **[Enter]** to confirm.

**MAX CURR=30.00A**

2. Set the maximum voltage value and press **[Enter]** to confirm.  
**MAX VOLT=120.00V**
3. Set the maximum power value and press **[Enter]** to confirm.  
**MAX POWER=300.00W**
4. Set the number of test steps, up to 10 steps, press **[Enter]** to confirm.  
**TEST STEP=10**
5. Set the mode of the step, move the left and right cursors, when the mode option flashes, it indicates that the mode is selected, press **[Enter]** to confirm (such as select CC mode).  
**MODE CC CV CW CR**
6. Set the current value and press **[Enter]** to confirm.  
**S01 CURR=\*\*A**
7. Set whether the step is short-circuited, move the left and right cursors to select, and press **[Enter]** to confirm.  
**SHORT ON OFF**
8. Set the type of value to be tested, move the left and right cursors to select, and press **[Enter]** to confirm (such as selecting the value of the test as the current value).  
**READBACK V A W**
9. Set the upper limit current value and press **[Enter]** to confirm.  
**S01 MAX=\*\*A**
10. Set the lower limit current value and press **[Enter]** to confirm.  
**S01 MIN=\*\*A**
11. Set the delay time. That is, the test value is read after the input is set for a certain period of time, and is used to test after the output is stable. The delay range is 0.1~25 seconds.  
**S01 DELAY=\*\*(S)**
12. Repeat steps 5 through 11 to set the automatic test parameters for the next steps.
13. Set the load voltage value. If no setting is required, set it to 0 and press **[Enter]** to confirm.  
**START= \*\*V**
14. Set the test stop conditions. COMP means that the test stops after all tests are completed, and FAILURE indicates that the test stops when an error occurs.  
**STOP COMP FAILURE**
15. Save the programmed file to EEPROM. You can save 50 groups of files. If you want to put the edited file in the first group, press 1 and press **[Enter]** to confirm.  
**SAVE PROGRAM =1 (1-50)**

 **Note**

In the process of editing the automatic test file, if an editing error occurs, you can press the up arrow key to return to the previous step to make changes without exiting the entire editing interface of the test file.

## Set the power-on state to automatic test

1. Press **[Shift] + [8]** (System) to enter the system menu.

**POWER-ON BUZZER**

2. Press the right key to the **RUNMODE**, and press **[Enter]**.

**RUNMODE DEFAULT**

3. Press the left or right key to select **PROG\_TEST** and press **[Enter]**, the menu will return to **RUNMODE**.

**RUN <PROG\_TEST**

4. Press **[Esc]** to exit.

**P01**



To exit the automatic test mode, press **[Shift] + [8]** (System) to enter the system menu and select **RUNMODE** as **NORMAL**.

## Recall the test file to run

The following method can quickly recall the existing test file from the EEPROM and test it after the instrument is powered on.

Operate in automatic test mode:

1. Press **[Shift] + [Enter]** (Recall).

**0.0000V 0.000A**

**RECALL PROGRAM=1 (0~10)**

2. Press the number keys to select the group and press **[Enter]**.

**0.0000V 0.000A**

**P01**

3. If the start voltage (Start) is set to 0 during the editing process, press **[Shift] + [.]** (Trigger) to trigger.

If the start voltage (Start) is set to a non-zero value, connect the DUT to start the test. The automatic test step will be displayed on the VFD and **FAULT** or **PASS** will be displayed after the test is over.

**0.0000V 0.000A**

**P01-01 2.100A**



Press **[Shift] + [0]** (Pause) to stop running the automatic test. Press  to continue testing.

# Chapter5 Specifications

## Specifications

Model		IT8511+	
Rated value ( 0~40 °C)	Input voltage	0~120V	
	Input current	0~3A	0~30A
	Input power	150W	
	Minimum operation value	0.14V at 3A	1.4V at 30A
CV mode	Range	0.1~18V	0.1~120V
	Resolution	1mV	10mV
	Accuracy	$\pm(0.05\%+0.02\%FS)$	$\pm(0.05\%+0.025\%FS)$
CC mode	Range	0~3A	0~30A
	Resolution	0.1mA	1mA
	Accuracy	$\pm(0.05\%+0.05\%FS)$	$\pm(0.05\%+0.05\%FS)$
CR mode *1	Range	0.05Ω~10Ω	10Ω~7.5KΩ
	Resolution	16bit	
	Accuracy	0.01%+0.08S *2	0.01%+0.0008S
CP mode *3	Range	150W	
	Resolution	10mW	
	Accuracy	$\pm(0.1\%+0.2\%FS)$	
<b>Dynamic mode</b>			
Dynamic mode	CC mode		
	T1&T2	20uS~3600S /Res:1 uS	
	Accuracy	2uS±100ppm	
	Rising/Falling slope *4	0.0001~0.2A/uS	0.001~1.5A/uS
	Minimum rise time *5	≅10uS	≅10uS
<b>Measuring range</b>			
Readback voltage	Range	0~18V	0~120V
	Resolution	0.1 mV	1 mV
	Accuracy	$\pm(0.025\%+0.025\%FS)$	$\pm(0.025\%+0.025\%FS)$
Readback current	Range	0~3A	0~30A
	Resolution	0.1mA	1mA
	Accuracy	$\pm(0.05\%+0.05\%FS)$	
Readback power	Range	150W	
	Resolution	10mW	
	Accuracy	$\pm(0.1\%+0.2\%FS)$	
<b>Protection range</b>			
OPP Protection	≅160W		
OCP Protection	≅3.3A	≅33A	
OVP Protection	≅125V		
OTP Protection	≅85°C		
<b>Specification</b>			
Short	Current( CC )	≅3.3/3A	≅33/30A

	Voltage( CV )	0V	0V
	Resistance( CR )	≈45mΩ	≈45mΩ
<b>Input Impedance</b>	150KΩ		
<b>Dimension</b>	214.5mm*88.2mm*354.6mm		

- \*1 The voltage/current input is no less than 10% FS
- \*2 The scope of read-back resistance is:  $1/(1/R+(1/R)*0.01\%+0.08), 1/(1/R-(1/R)*0.01\%-0.08)$
- \*3 The voltage/current input is no less than 10% FS
- \*4 Ascending/descending slope: 10%-90% current ascending slope from 0 to maximum current.
- \*5 Minimum rise time: 10%-90% current rise time

Model		IT8512+	
<b>Rated value</b> ( 0~40 °C)	Input voltage	0~120V	
	Input current	0~3A	0~30A
	Input power	300W	
	Minimum operation value	0.12V at 3A	1.2V at 30A
<b>CV mode</b>	Range	0.1~18V	0.1~120V
	Resolution	1mV	10mV
	Accuracy	±(0.05%+0.02%FS)	±(0.05%+0.025%FS)
<b>CC mode</b>	Range	0~3A	0~30A
	Resolution	0.1mA	1mA
	Accuracy	±(0.05%+0.05%FS)	±(0.05%+0.05%FS)
<b>CR mode</b> *1	Range	0.05Ω~10Ω	10Ω~7.5KΩ
	Resolution	16bit	
	Accuracy	0.01%+0.08S *2	0.01%+0.0008S
<b>CP mode</b> *3	Range	300W	
	Resolution	10mW	
	Accuracy	±(0.1%+0.2%FS)	
Dynamic mode			
<b>Dynamic mode</b>	CC mode		
	T1&T2	20uS~3600S /Res:1 uS	
	Accuracy	2uS±100ppm	
	Rising/Falling slope *4	0.0001~0.2A/uS	0.001~1.5A/uS
	Minimum rise time *5	≈10uS	≈10uS
Measuring range			
<b>Readback voltage</b>	Range	0~18V	0~120V
	Resolution	0.1 mV	1 mV
	Accuracy	±(0.025%+0.025%FS)	±(0.025%+0.025%FS)
<b>Readback current</b>	Range	0~3A	0~30A
	Resolution	0.1mA	1mA
	Accuracy	±(0.05%+0.05%FS)	
<b>Readback power</b>	Range	300W	
	Resolution	10mW	
	Accuracy	±(0.1%+0.2%FS)	
Protection range			
<b>OPP Protection</b>	≈320W		
<b>OCP Protection</b>	≈3.3A	≈33A	
<b>OVP Protection</b>	≈125V		

OTP Protection	≒85°C		
<b>Specification</b>			
Short	Current( CC )	≒3.3/3A	≒33/30A
	Voltage( CV )	0V	0V
	Resistance( CR )	≒40mΩ	≒40mΩ
Input Impedance	150KΩ		
Dimension	214.5mm*88.2mm*354.6mm		

- \*1 The voltage/current input is no less than 10% FS  
 \*2 The scope of read-back resistance is:  $(1/(1/R+(1/R)*0.01\%+0.08),1/(1/R-(1/R)*0.01\%-0.08))$   
 \*3 The voltage/current input is no less than 10% FS  
 \*4 Ascending/descending slope: 10%-90% current ascending slope from 0 to maximum current.  
 \*5 Minimum rise time: 10%-90% current rise time

Model		IT8511A+		IT8512A+	
Rated value (0~40 °C)	Input voltage	0~150V		0~150V	
	Input current	0~3A	0~30A	0~3A	0~30A
	Input power	150W		300W	
	Minimum operation value	0.25V at 3A	2.5V at 30A	0.14V at 3A	1.4V at 30A
CV mode	Range	0.1~18V	0.1~150V	0.1~18V	0.1~150V
	Resolution	1mV	10mV	1mV	10mV
	Accuracy	$\pm(0.05\%+0.02\%FS)$	$\pm(0.05\%+0.025\%FS)$	$\pm(0.05\%+0.02\%FS)$	$\pm(0.05\%+0.025\%FS)$
CC mode	Range	0~3A	0~30A	0~3A	0~30A
	Resolution	0.1mA	1mA	0.1mA	1mA
	Accuracy	$\pm(0.05\%+0.05\%FS)$	$\pm(0.05\%+0.05\%FS)$	$\pm(0.05\%+0.05\%FS)$	$\pm(0.05\%+0.05\%FS)$
CR mode *1	Range	0.05Ω~10Ω	10Ω~7.5KΩ	0.05Ω~10Ω	10Ω~7.5KΩ
	Resolution	16bit		16bit	
	Accuracy	0.01%+0.08S *2	0.01%+0.0008S	0.01%+0.08S *2	0.01%+0.0008S
CP mode *3	Range	150W		300W	
	Resolution	10mW		10mW	
	Accuracy	$\pm(0.1\%+0.1\%FS)$		$\pm(0.1\%+0.1\%FS)$	
<b>Dynamic mode( CC mode )</b>					
T1&T2		20uS~3600S /Res:1 uS		20uS~3600S /Res:1 uS	
Accuracy		2uS±100ppm		2uS±100ppm	
Rising/Falling slope *4		0.0001~0.2 A/uS	0.001~1.5A/uS	0.0001~0.2A/uS	0.001~1.5A/uS
Minimum rise time *5		≒10uS	≒10uS	≒10uS	≒10uS
<b>Measuring range</b>					
Readback voltage	Range	0~18V	0~150V	0~18V	0~150V
	Resolution	0.1 mV	1 mV	0.1 mV	1 mV
	Accuracy	$\pm(0.025\%+0.025\%FS)$	$\pm(0.025\%+0.025\%FS)$	$\pm(0.025\%+0.025\%FS)$	$\pm(0.025\%+0.025\%FS)$
Readback current	Range	0~3A	0~30A	0~3A	0~30A
	Resolution	0.1mA	1mA	0.1mA	1mA
	Accuracy	$\pm(0.05\%+0.05\%FS)$		$\pm(0.05\%+0.05\%FS)$	
Readback power	Range	150W		300W	
	Resolution	10mW		10mW	
	Accuracy	$\pm(0.1\%+0.1\%FS)$		$\pm(0.1\%+0.1\%FS)$	

Protection range					
OPP Protection	≈160W			≈320W	
OCP Protection	≈3.3A	≈33A		≈3.3A	≈33A
OVP Protection	≈160V			≈160V	
OTP Protection	≈85°C			≈85°C	
Specification					
Short	Current( CC )	≈3.3/3A	≈33/30A	≈3.3/3A	≈33/30A
	Voltage( CV )	0V	0V	0V	0V
	Resistance( CR )	≈80mΩ	≈80mΩ	≈40mΩ	≈40mΩ
Input Impedance	150KΩ			150KΩ	
Dimension	214.5mm*88.2mm*354.6mm			214.5mm*88.2mm*354.6mm	

\*1 The voltage/current input is no less than 10% FS

\*2 The scope of read-back resistance is:  $(1/(1/R+(1/R)*0.01\%+0.08), 1/(1/R-(1/R)*0.01\%-0.08))$

\*3 The voltage/current input is no less than 10% FS

\*4 Ascending/descending slope: 10%-90% current ascending slope from 0 to maximum current.

\*5 Minimum rise time: 10%-90% current rise time

Model		IT8511B+			
Rated value ( 0~40 °C)	Input voltage	0~500V			
	Input current	0~3A		0~10A	
	Input power	150W			
	Minimum operation value	1.2V at 3A		4V at 10A	
CV mode	Range	0.1~50V		0.1~500V	
	Resolution	1mV		10mV	
	Accuracy	±(0.05%+0.05%FS)		±(0.05%+0.05%FS)	
CC mode	Range	0~3A		0~10A	
	Resolution	0.1mA		1mA	
	Accuracy	±(0.05%+0.05%FS)		±(0.05%+0.05%FS)	
CR mode *1	Range	0.5Ω~10Ω		10Ω~7.5KΩ	
	Resolution	16bit			
	Accuracy	0.01%+0.08S *2		0.01%+0.0008S	
CP mode *3	Range	150W			
	Resolution	10mW			
	Accuracy	0.1%+0.2%FS			
Dynamic mode					
Dynamic mode	CC mode				
	T1&T2	20uS~3600S /Res:1 uS			
	Accuracy	2uS±100ppm			
	Rising/Falling slope *4	0.0001~0.2A/uS		0.001~0.8A/uS	
	Minimum rise time *5	≈10uS		≈10uS	
Measuring range					
Readback voltage	Range	0~50V		0~500V	
	Resolution	1 mV		10 mV	
	Accuracy	±(0.025%+0.025%FS)		±(0.025%+0.025%FS)	
Readback current	Range	0~3A		0~10A	
	Resolution	0.1mA		1mA	
	Accuracy	±(0.05%+0.05%FS)			

Readback power	Range	150W	
	Resolution	10mW	
	Accuracy	$\pm(0.1\%+0.2\%FS)$	
<b>Protection range</b>			
OPP Protection	$\approx 160W$		
OCP Protection	$\approx 3.3A$	$\approx 11A$	
OVP Protection	$\approx 530V$		
OTP Protection	$\approx 85^{\circ}C$		
<b>Specification</b>			
Short	Current( CC )	$\approx 3.3/3A$	$\approx 11/10A$
	Voltage( CV )	0V	0V
	Resistance( C R )	$\approx 400m\Omega$	$\approx 400m\Omega$
Input Impedance	1M $\Omega$		
Dimension	214.5mm*88.2mm*354.6mm		

- \*1 The voltage/current input is no less than 10% FS
- \*2 The scope of read-back resistance is:  $1/(1/R+(1/R)*0.01\%+0.08), 1/(1/R-(1/R)*0.01\%-0.08)$
- \*3 The voltage/current input is no less than 10% FS
- \*4 Ascending/descending slope: 10%-90% current ascending slope from 0 to maximum current.
- \*5 Minimum rise time: 10%-90% current rise time

Model		IT8512B+	
Rated value (0~40 °C)	Input voltage	0~500V	
	Input current	0~3A	0~15A
	Input power	300W	
	Minimum operation value	0.6V at 3A	3V at 15A
CV mode	Range	0.1~50V	0.1~500V
	Resolution	1mV	10mV
	Accuracy	$\pm(0.05\%+0.05\%FS)$	$\pm(0.05\%+0.05\%FS)$
CC mode	Range	0~3A	0~15A
	Resolution	0.1mA	1mA
	Accuracy	$\pm(0.05\%+0.05\%FS)$	$\pm(0.05\%+0.05\%FS)$
CR mode *1	Range	0.3 $\Omega$ ~10 $\Omega$	10 $\Omega$ ~7.5K $\Omega$
	Resolution	16bit	
	Accuracy	0.01%+0.08S *2	0.01%+0.0008S
CP mode *3	Range	300W	
	Resolution	10mW	
	Accuracy	0.1%+0.2%FS	
<b>Dynamic mode</b>			
Dynamic mode	CC mode		
	T1&T2	20uS~3600S /Res:1 uS	
	Accuracy	2uS $\pm$ 100ppm	
	Rising/Falling slope *4	0.0001~0.2A/uS	0.001~0.8A/uS
	Minimum rise time *5	$\approx 10uS$	$\approx 10uS$
<b>Measuring range</b>			
Readback voltage	Range	0~50V	0~500V
	Resolution	1 mV	10 mV



	Accuracy	$\pm(0.025\%+0.025\%FS)$	$\pm(0.025\%+0.025\%FS)$
Readback current	Range	0~3A	0~15A
	Resolution	0.1mA	1mA
	Accuracy	$\pm(0.05\%+0.05\%FS)$	
Readback power	Range	300W	
	Resolution	10mW	
	Accuracy	$\pm(0.1\%+0.2\%FS)$	
<b>Protection range</b>			
OPP Protection	$\approx 320W$		
OCP Protection	$\approx 3.3A$	$\approx 16A$	
OVP Protection	$\approx 530V$		
OTP Protection	$\approx 85^{\circ}C$		
<b>Specification</b>			
Short	Current( CC )	$\approx 3.3/3A$	$\approx 16/15A$
	Voltage( CV )	0V	0V
	Resistance( CR )	$\approx 180m\Omega$	$\approx 180m\Omega$
Input Impedance	1M $\Omega$		
Dimension	214.5mm*88.2mm*354.6mm		

\*1 The voltage/current input is no less than 10% FS

\*2 The scope of read-back resistance is:  $(1/(1/R+(1/R)*0.01\%+0.08),1/(1/R-(1/R)*0.01\%-0.08))$

\*3 The voltage/current input is no less than 10% FS

\*4 Ascending/descending slope: 10%-90% current ascending slope from 0 to maximum current.

\*5 Minimum rise time: 10%-90% current rise time

Model		IT8512C+	
Rated value (0~40 °C)	Input voltage	0~120V	
	Input current	0~6A	0~60A
	Input power	300W	
	Minimum operation value	0.25V at 6A	2.5V at 60A
CV mode	Range	0.1~18V	0.1~120V
	Resolution	1mV	10mV
	Accuracy	$\pm(0.05\%+0.02\%FS)$	$\pm(0.05\%+0.025\%FS)$
CC mode	Range	0~6A	0~60A
	Resolution	0.1mA	1mA
	Accuracy	$\pm(0.05\%+0.05\%FS)$	$\pm(0.05\%+0.1\%FS)$
CR mode *1	Range	0.05 $\Omega$ ~10 $\Omega$	10 $\Omega$ ~7.5K $\Omega$
	Resolution	16bit	
	Accuracy	0.01%+0.08S *2	0.01%+0.0008S
CP mode *3	Range	300W	
	Resolution	10mW	
	Accuracy	$\pm(0.1\%+0.3\%FS)$	
<b>Dynamic mode</b>			
Dynamic mode	CC mode		
	T1&T2	20uS~3600S /Res:1 uS	
	Accuracy	2uS $\pm$ 100ppm	
	Rising/Falling slope *4	0.0001~0.3A/uS	0.001~3A/uS

	Minimum rise time *5	$\approx 10\mu\text{S}$	$\approx 10\mu\text{S}$
<b>Measuring range</b>			
Readback voltage	Range	0~18V	0~120V
	Resolution	0.1 mV	1 mV
	Accuracy	$\pm(0.025\%+0.025\%FS)$	$\pm(0.025\%+0.025\%FS)$
Readback current	Range	0~6A	0~60A
	Resolution	0.1mA	1mA
	Accuracy	$\pm(0.05\%+0.05\%FS)$	$\pm(0.05\%+0.1\%FS)$
Readback power	Range	300W	
	Resolution	10mW	
	Accuracy	$\pm(0.1\%+0.3\%FS)$	
<b>Protection range</b>			
OPP Protection		$\approx 320\text{W}$	
OCP Protection		$\approx 6.5\text{A}$	$\approx 65\text{A}$
OVP Protection		$\approx 125\text{V}$	
OTP Protection		$\approx 85^\circ\text{C}$	
<b>Specification</b>			
Short	Current( CC )	$\approx 6.5/6\text{A}$	$\approx 65/60\text{A}$
	Voltage( CV )	0V	0V
	Resistance( C R )	$\approx 40\text{m}\Omega$	$\approx 40\text{m}\Omega$
Input Impedance		150K $\Omega$	
Dimension		214.5mm*88.2mm*354.6mm	

\*1 The voltage/current input is no less than 10% FS

\*2 The scope of read-back resistance is:  $(1/(1/R+(1/R)*0.01\%+0.08), 1/(1/R-(1/R)*0.01\%-0.08))$

\*3 The voltage/current input is no less than 10% FS

\*4 Ascending/descending slope: 10%-90% current ascending slope from 0 to maximum current.

\*5 Minimum rise time: 10%-90% current rise time

Model		IT8512H+	
Rated value ( 0~40 °C )	Input voltage	0~800V	
	Input current	0~1A	0~5A
	Input power	300W	
	Minimum operation value	1.4V at 1A	7V at 5A
CV mode	Range	0.1~80V	0.1~800V
	Resolution	1mV	10mV
	Accuracy	$\pm(0.05\%+0.05\%FS)$	$\pm(0.05\%+0.05\%FS)$
CC mode	Range	0~1A	0~5A
	Resolution	0.1mA	1mA
	Accuracy	$\pm(0.05\%+0.1\%FS)$	$\pm(0.05\%+0.05\%FS)$
CR mode *1	Range	2 $\Omega$ ~10 $\Omega$	10 $\Omega$ ~7.5K $\Omega$
	Resolution	16bit	
	Accuracy	0.01%+0.08S *2	0.01%+0.0008S
CP mode *3	Range	300W	
	Resolution	10mW	
	Accuracy	0.2%+0.2%FS	
<b>Dynamic mode</b>			

<b>Dynamic mode</b>	CC mode		
	T1&T2	20uS~3600S /Res:1 uS	
	Accuracy	2uS±100ppm	
	Rising/Falling slope *4	0.0001~0.04A/uS	0.001~0.2A/uS
	Minimum rise time *5	≈20uS	≈20uS
<b>Measuring range</b>			
<b>Readback voltage</b>	Range	0~80V	0~800V
	Resolution	1 mV	10 mV
	Accuracy	±(0.025%+0.025%FS)	
<b>Readback current</b>	Range	0~1A	0~5A
	Resolution	0.1mA	1mA
	Accuracy	±(0.05%+0.05%FS)	
<b>Readback power</b>	Range	300W	
	Resolution	10mW	
	Accuracy	±(0.2%+0.2%FS)	
<b>Protection range</b>			
<b>OPP Protection</b>	≈320W		
<b>OCP Protection</b>	≈1.1A	≈5.5A	
<b>OVP Protection</b>	≈850V		
<b>OTP Protection</b>	≈85°C		
<b>Specification</b>			
<b>Short</b>	Current( CC )	≈1.1/1A	≈5.5/5A
	Voltage( CV )	0V	0V
	Resistance( C R )	≈1.4Ω	
<b>Input Impedance</b>	2MΩ		
<b>Dimension</b>	214.5mm*88.2mm*354.6mm		

\*1 The voltage/current input is no less than 10% FS

\*2 The scope of read-back resistance is:  $1/(1/R+(1/R)*0.01\%+0.08), 1/(1/R-(1/R)*0.01\%-0.08)$

\*3 The voltage/current input is no less than 10% FS

\*4 Ascending/descending slope: 10%-90% current ascending slope from 0 to maximum current.

\*5 Minimum rise time: 10%-90% current rise time

Model		IT8513A+	
<b>Rated value</b> (0~40 °C)	Input voltage	0~150V	
	Input current	0~6A	0~60A
	Input power	400W	
	Minimum operation value	0.25V at 6A	2.5V at 60A
<b>CV mode</b>	Range	0.1~18V	0.1~150V
	Resolution	1mV	10mV
	Accuracy	±(0.05%+0.02%FS)	±(0.05%+0.025%FS)
<b>CC mode</b>	Range	0~6A	0~60A
	Resolution	0.1mA	1mA
	Accuracy	±(0.05%+0.05%FS)	±(0.05%+0.05%FS)
<b>CR mode</b> *1	Range	0.1Ω~10Ω	10Ω~7.5KΩ
	Resolution	16bit	

	Accuracy	0.01%+0.08S *2	0.01%+0.0008S
<b>CP mode</b> *3	Range	400W	
	Resolution	10mW	
	Accuracy	±(0.2%+0.2%FS)	
	<b>Dynamic mode</b>		
<b>Dynamic mode</b>	CC mode		
	T1&T2	100uS~3600S /Res:1 uS	
	Accuracy	10Us+100ppm	
	Rising/Falling slope *4	0.001~0.15A/uS	0.01~1 A/uS
	Minimum rise time *5	≅50uS	≅60uS
<b>Measuring range</b>			
<b>Readback voltage</b>	Range	0~18V	0~150V
	Resolution	0.1 mV	1mV
	Accuracy	±(0.025%+0.025%FS)	±(0.025%+0.025%FS)
<b>Readback current</b>	Range	0~6A	0~60A
	Resolution	0.1mA	1mA
	Accuracy	±(0.05%+0.05%FS)	
<b>Readback power</b>	Range	400W	
	Resolution	10mW	
	Accuracy	±(0.2%+0.2%FS)	
<b>Protection range</b>			
<b>OPP Protection</b>	≅420W		
<b>OCP Protection</b>	≅6.6A	≅66A	
<b>OVP Protection</b>	≅165V		
<b>OTP Protection</b>	≅85°C		
<b>Specification</b>			
<b>Short</b>	Current( CC )	≅6.6/6A	≅66/60A
	Voltage( CV )	≅0V	
	Resistance( C R )	≅30mΩ	
<b>Input Impedance</b>	≅280KΩ		
<b>Dimension</b>	214.5mm*88.2mm*453.5mm		

\*1 The voltage/current input is no less than 10% FS

\*2 The scope of read-back resistance is:  $(1/(1/R+(1/R)*0.01\%+0.08), 1/(1/R-(1/R)*0.01\%-0.08))$

\*3 The voltage/current input is no less than 10% FS

\*4 Ascending/descending slope: 10%-90% current ascending slope from 0 to maximum current.

\*5 Minimum rise time: 10%-90% current rise time

Model		IT8513B+	
<b>Rated value</b> ( 0~40 °C )	Input voltage	0~500V	
	Input current	0~3A	0~30A
	Input power	600W	
	Minimum operation value	0.3V at 3A	3V at 30A
<b>CV mode</b>	Range	0.1~50V	0.1~500V
	Resolution	1mV	10mV
	Accuracy	±(0.05%+0.05%FS)	±(0.05%+0.05%FS)
<b>CC mode</b>	Range	0~3A	0~30A

	Resolution	1mA	10mA
	Accuracy	$\pm(0.05\%+0.05\%FS)$	$\pm(0.05\%+0.05\%FS)$
CR mode *1	Range	0.Ω~10Ω	10Ω~7.5KΩ
	Resolution	16bit	
	Accuracy	0.02%+0.08S *2	0.02%+0.0008S
CP mode *3	Range	600W	
	Resolution	10mW	
	Accuracy	$\pm(0.2\%+0.2\%FS)$	
<b>Dynamic mode</b>			
Dynamic mode	CC mode		
	T1&T2	100uS~3600S /Res:1 uS	
	Accuracy	10uS±100ppm	
	Rising/Falling slope *4	0.001~0.05A/uS	0.01~0.5A/uS
	Minimum rise time *5	≈60uS	≈60uS
<b>Measuring range</b>			
Readback voltage	Range	0~50V	0~500V
	Resolution	1 mV	10mV
	Accuracy	$\pm(0.025\%+0.025\%FS)$	$\pm(0.025\%+0.025\%FS)$
Readback current	Range	0~3A	0~30A
	Resolution	1mA	10mA
	Accuracy	$\pm(0.05\%+0.05\%FS)$	
Readback power	Range	600W	
	Resolution	10mW	
	Accuracy	$\pm(0.2\%+0.2\%FS)$	
<b>Protection range</b>			
OPP Protection	≈650W		
OCP Protection	≈3.3A	≈33A	
OVP Protection	≈530V		
OTP Protection	≈85°C		
<b>Specification</b>			
Short	Current( CC )	≈3.4/3A	≈34/30A
	Voltage( CV )	0V	0V
	Resistance( C R )	≈100mΩ	≈100mΩ
Input Impedance	1MΩ		
Weight	436.5mm*88.2mm*463.5mm		

\*1 The voltage/current input is no less than 10% FS

\*2 The scope of read-back resistance is:  $1/(1/R+(1/R)*0.02\%+0.08)$ ,  $1/(1/R-(1/R)*0.02\%-0.08)$

\*3 The voltage/current input is no less than 10% FS

\*4 Ascending/descending slope: 10%-90% current ascending slope from 0 to maximum current.

\*5 Minimum rise time: 10%-90% current rise time

Model		IT8513C+	
Rated value (0~40 °C)	Input voltage	0~120V	
	Input current	0~12A	0~120A
	Input power	600W	

	Minimum operation value	0.2V at 12A	2V at 120A
CV mode	Range	0.1~18V	0.1~120V
	Resolution	1mV	10mV
	Accuracy	$\pm(0.05\%+0.02\%FS)$	$\pm(0.05\%+0.025\%FS)$
CC mode	Range	0~12A	0~120A
	Resolution	1mA	10mA
	Accuracy	$\pm(0.05\%+0.05\%FS)$	$\pm(0.05\%+0.1\%FS)$
CR mode *1	Range	0.05Ω~10Ω	10Ω~7.5KΩ
	Resolution	16bit	
	Accuracy	0.01%+0.08S *2	0.01%+0.0008S
CP mode *3	Range	600W	
	Resolution	10mW	
	Accuracy	$\pm(0.2\%+0.2\%FS)$	
<b>Dynamic mode</b>			
Dynamic mode		CC mode	
	T1&T2	100uS~3600S /Res:1 uS	
	Accuracy	10uS±100ppm	
	Rising/Falling slope *4	0.001~0.2A/uS	0.01~1.6A/uS
	Minimum rise time *5	≈60uS	≈60uS
<b>Measuring range</b>			
Readback voltage	Range	0~18V	0~120V
	Resolution	0.1 mV	1mV
	Accuracy	$\pm(0.025\%+0.025\%FS)$	$\pm(0.025\%+0.025\%FS)$
Readback current	Range	0~12A	0~120A
	Resolution	1mA	10mA
	Accuracy	$\pm(0.05\%+0.05\%FS)$	$\pm(0.05\%+0.1\%FS)$
Readback power	Range	600W	
	Resolution	10mW	
	Accuracy	$\pm(0.2\%+0.2\%FS)$	
<b>Protection range</b>			
OPP Protection		≈620W	
OCP Protection		≈13A	≈130A
OVP Protection		≈125V	
OTP Protection		≈95°C	
<b>Specification</b>			
Short	Current( CC )	≈13/12A	≈130/120A
	Voltage( CV )	0V	0V
	Resistance( CR )	≈15mΩ	≈15mΩ
Input Impedance		150KΩ	
Weight		7.1KG	
Dimension		214.5mm*88.2mm*453.5mm	

\*1 The voltage/current input is no less than 10% FS

\*2 The scope of read-back resistance is:  $1/(1/R+(1/R)*0.01\%+0.08)$ ,  $1/(1/R-(1/R)*0.01\%-0.08)$

\*3 The voltage/current input is no less than 10% FS

\*4 Ascending/descending slope: 10%-90% current ascending slope from 0 to maximum current.

**\*5 Minimum rise time: 10%-90% current rise time**

Model		IT8514C+	
Rated value (0~40 °C)	Input voltage	0~120V	
	Input current	0~24A	0~240A
	Input power	1500W	
	Minimum operation value	0.25V at 24A	2.5V at 240A
CV mode	Range	0.1~18V	0.1~120V
	Resolution	1mV	10mV
	Accuracy	±(0.05%+0.02%FS)	±(0.05%+0.025%FS)
CC mode	Range	0~24A	0~240A
	Resolution	1mA	10mA
	Accuracy	±(0.1%+0.1%FS)	
CR mode *1	Range	0.05Ω~10Ω	10Ω~7.5KΩ
	Resolution	16bit	
	Accuracy	0.02%+0.08S *2	0.02%+0.0008S
CP mode *3	Range	1500W	
	Resolution	10mW	
	Accuracy	±(0.2%+0.2%FS)	
<b>Dynamic mode</b>			
CC mode			
T1&T2	100uS~3600S /Res:1 uS		
Accuracy	10uS±100ppm		
Rising/Falling slope *4	0.001~0.3A/uS	0.01~3.2A/uS	
Minimum rise time *5	≒60uS	≒60uS	
<b>Measuring range</b>			
Readback voltage	Range	0~18V	0~120V
	Resolution	0.1 mV	1mV
	Accuracy	±(0.025%+0.025%FS)	
Readback current	Range	0~24A	0~240A
	Resolution	1mA	10mA
	Accuracy	±(0.05%+0.05%FS)	
Readback power	Range	1500W	
	Resolution	10mW	
	Accuracy	±(0.2%+0.2%FS)	
<b>Protection range</b>			
OPP Protection	≒1550W		
OCP Protection	≒26.7A	≒267A	
OVP Protection	≒125V		
OTP Protection	≒85°C		
<b>Specification</b>			
Short	Current( CC )	≒26.7/24A	≒267/240A
	Voltage( CV )	0V	0V
	Resistance( CR )	≒8mΩ	≒8mΩ
Input Impedance	150KΩ		
Dimension	436.5mm*88.2mm*463.5mm		

\*1 The voltage/current input is no less than 10% FS

\*2 The scope of read-back resistance is:  $(1/(1/R+(1/R)*0.02\%+0.08), 1/(1/R-(1/R)*0.02\%-0.08))$

- \*3 The voltage/current input is no less than 10% FS
- \*4 Ascending/descending slope: 10%-90% current ascending slope from 0 to maximum current.
- \*5 Minimum rise time: 10%-90% current rise time

Model		IT8514B+	
Rated value (0~40 °C)	Input voltage	0~500V	
	Input current	0~6A	0~60A
	Input power	1500W	
	Minimum operation value	0.3V at 6A	3V at 60A
CV mode	Range	0.1~50V	0.1~500V
	Resolution	1mV	10mV
	Accuracy	$\pm(0.05\%+0.05\%FS)$	$\pm(0.05\%+0.05\%FS)$
CC mode	Range	0~6A	0~60A
	Resolution	1mA	10mA
	Accuracy	$\pm(0.05\%+0.05\%FS)$	$\pm(0.05\%+0.05\%FS)$
CR mode *1	Range	0.05Ω~10Ω	10Ω~7.5KΩ
	Resolution	16bit	
	Accuracy	0.02%+0.08S *2	0.02%+0.0008S
CP mode *3	Range	1500W	
	Resolution	10mW	
	Accuracy	$\pm(0.2\%+0.2\%FS)$	
<b>Dynamic mode</b>			
Dynamic mode	CC mode		
	T1&T2	100uS~3600S /Res:1 uS	
	Accuracy	10uS±100ppm	
	Rising/Falling slope *4	0.001~0.15A/uS	0.01~0.8A/uS
	Minimum rise time *5	≈60uS	≈60uS
<b>Measuring range</b>			
Readback voltage	Range	0~50V	0~500V
	Resolution	0.1 mV	1mV
	Accuracy	$\pm(0.025\%+0.025\%FS)$	$\pm(0.025\%+0.025\%FS)$
Readback current	Range	0~6A	0~60A
	Resolution	1mA	10mA
	Accuracy	$\pm(0.05\%+0.05\%FS)$	
Readback power	Range	1500W	
	Resolution	10mW	
	Accuracy	$\pm(0.2\%+0.2\%FS)$	
<b>Protection range</b>			
OPP Protection	≈1550W		
OCP Protection	≈6.7A	≈67A	
OVP Protection	≈530V		
OTP Protection	≈85°C		
<b>Specification</b>			
Short	Current( CC )	≈6.7/6A	≈67/60A
	Voltage( CV )	0V	0V
	Resistance( C R )	≈50mΩ	≈50mΩ



<b>Input Impedance</b>	1MΩ
<b>Dimension</b>	436.5mm*88.2mm*463.5mm

- \*1 The voltage/current input is no less than 10% FS
- \*2 The scope of read-back resistance is:  $(1/(1/R+(1/R)*0.02\%+0.08), 1/(1/R-(1/R)*0.02\%-0.08))$
- \*3 The voltage/current input is no less than 10% FS
- \*4 Ascending/descending slope: 10%-90% current ascending slope from 0 to maximum current.
- \*5 Minimum rise time: 10%-90% current rise time

Model		IT8516C+	
<b>Rated value</b> (0~40 °C)	Input voltage	0~120V	
	Input current	0~24A	0~240A
	Input power	3000W	
	Minimum operation value	0.15V at 24A	1.5V at 240A
<b>CV mode</b>	Range	0.1~18V	0.1~120V
	Resolution	1mV	10mV
	Accuracy	$\pm(0.05\%+0.025\%FS)$	$\pm(0.05\%+0.025\%FS)$
<b>CC mode</b>	Range	0~24A	0~240A
	Resolution	1mA	10mA
	Accuracy	$\pm(0.1\%+0.1\%FS)$	$\pm(0.1\%+0.1\%FS)$
<b>CR mode</b> *1	Range	0.05Ω~10Ω	10Ω~7.5KΩ
	Resolution	16bit	
	Accuracy	0.02%+0.08S *2	0.02%+0.0008S
<b>CP mode</b> *3	Range	3000W	
	Resolution	10mW	
	Accuracy	$\pm(0.2\%+0.2\%FS)$	
<b>Dynamic mode</b>			
<b>Dynamic mode</b>	CC mode		
	T1&T2	120uS~3600S /Res:1 uS	
	Accuracy	10uS+100ppm	
	Rising/Falling slope *4	0.001~0.25A/uS	0.01~2.5A/uS
	Minimum rise time *5	$\cong 70uS$	$\cong 70uS$
<b>Measuring range</b>			
<b>Readback voltage</b>	Range	0~18V	0~120V
	Resolution	0.1 mV	1mV
	Accuracy	$\pm(0.025\%+0.025\%FS)$	$\pm(0.025\%+0.025\%FS)$
<b>Readback current</b>	Range	0~24A	0~240A
	Resolution	1mA	10mA
	Accuracy	$\pm(0.1\%+0.1\%FS)$	
<b>Readback power</b>	Range	3000W	
	Resolution	10mW	
	Accuracy	$\pm(0.2\%+0.2\%FS)$	
<b>Protection range</b>			
<b>OPP Protection</b>	$\cong 3000W$		
<b>OCP Protection</b>	$\cong 26A$	$\cong 260A$	
<b>OVP Protection</b>	$\cong 125V$		
<b>OTP Protection</b>	$\cong 85^{\circ}C$		
<b>Specification</b>			

<b>Short</b>	Current( CC )	$\approx 26/24A$	$\approx 260/240A$
	Voltage( CV )	0V	0V
	Resistance( CR )	$\approx 6m\Omega$	$\approx 6m\Omega$
<b>Input Impedance</b>	$\approx 300K\Omega$		
<b>Dimension</b>	436.5mm*176mm*463.5mm		

- \*1 The voltage/current input is no less than 10% FS
- \*2 The scope of read-back resistance is:  $(1/(1/R+(1/R)*0.02\%+0.08), 1/(1/R-(1/R)*0.02\%-0.08))$
- \*3 The voltage/current input is no less than 10% FS
- \*4 Ascending/descending slope: 10%-90% current ascending slope from 0 to maximum current.
- \*5 Minimum rise time: 10%-90% current rise time

\* The above specifications may be subject to change without prior notice.

## Supplementary Characteristics

- Memory capacity: 100 registers  
Suggested calibration frequency: Once a year
- AC input level (A transfer switch is selectable on the rear panel)  
Option Opt.1: 220V  $\pm 10\%$  50Hz/60Hz  
Option Opt.2: 110V  $\pm 10\%$  50Hz/60Hz
- Cooling type  
Intelligent fans
- Fans working principle:  
Fans running speed is determined by radiator temperature. When temperature reaches 40°C, fans start to work and intelligently adjust its speed with temperature variation.

# Chapter6 Communication Interfaces

## 6.1 Communication Modules Introduction

DB9 in the rear panel of the DC load IT8511+/IT8511A+/IT8511B+/IT8512+/IT8512A+/IT8512B+/IT8512C+/IT8512H+/IT8513A+/IT8513C+ is TTL level, which can be connected to the serial port of the PC through the level conversion of the accessory.

The communication module is IT-E121/IT-E121A/IT-E122/IT-E123.

The IT8513B+/IT8514B+/IT8514C+/IT8516C+ comes standard with RS232 and USB communication interfaces.

### CAUTION

Please do not connect the standard RS232 cable to the IT8511+/IT8511A+/IT8511B+/IT8512+/IT8512A+/IT8512B+/IT8512C+/IT8512H+/IT8513A+/IT8513C+ electronic load, which may damage the instrument.

### IT-E121 Communication Module

The DB9 interface connector on the rear panel of the DC load is TTL voltage level; you can use the communication module IT-E121 and a standard RS232 extension cable to connect the DB9 interface connector of the DC load and the RS-232 interface connector of computer for the communication.

IT-E121 communication cable

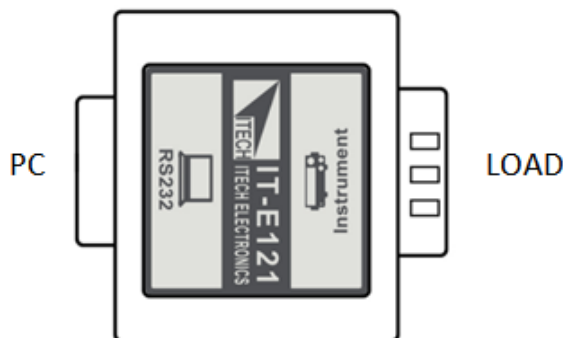

### IT-E121A Communication Module

The DB9 interface connector on the rear panel of the DC load is TTL voltage level; you can use the communication module IT-E121A and a standard RS232 extension cable to connect the DB9 interface connector of the DC load and the RS-232 interface connector of computer for the communication.

IT-E121A is derived on the basis of IT-E121, the main difference between them is that the DB9 interface connector of the RS232 changes from female to male, so that can be directly connected to the standard LAN interface.

IT-E121A communication cable

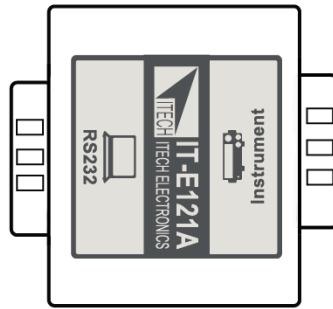

## IT-E122 Communication Module

The DB9 interface connector on the rear panel of the DC load is TTL voltage level; IT-E122 has a USB interface (male connector B) on one end, you can use IT-E122 and a standard USB extension cable (type B female connector at one end and type A at one end) to connect the DB9 interface connector of the DC load and the USB interface connector of computer for the communication.

After connecting the load and computer by USB, you need to install IT-E122 driver (download from

<http://www.itech.sh/support/Down-3.htm?model=IT-E122%E5%85%89%E9%9A%94%E7%A6%BB%E9%80%9A%E8%AE%AF%E6%8E%A5%E5%8F%A3%E9%A9%B1%E5%8A%A8> or contact ITECH agent). The device manager of PC will display 'Prolific USB-to-Serial COM Port' after installing.

### IT-E122 communication cable

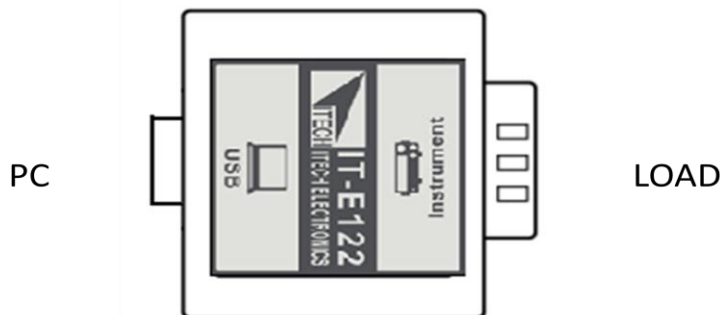

## IT-E123 Communication Module

The DB9 interface connector on the rear panel of the DC load is TTL voltage level;

The interface on both side port of IT-E123 are DB9 interface and RS485 interface, you can use the communication module IT-E123 and an a standard RS485-RS232 conversion cable to connect the DB9 interface connector of the DC load and the RS-232 interface connector of computer for the communication.

## IT-E123 communication cable

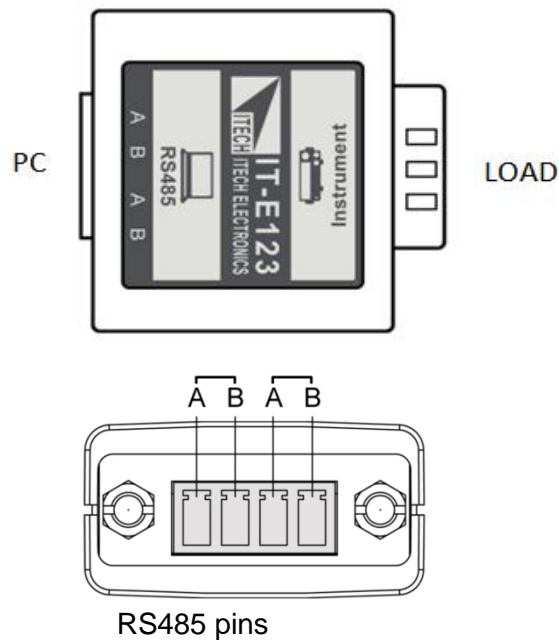

## 6.2 Communication with PC

Before using the remote operation mode, please make sure that the baud rate and communication address in the DC load are the same as in the computer software, otherwise, the communication will fail, you can change the baud rate and communication address from the front panel or from computer.

### DB9 Serial Port

In order for the computer to communicate with the DC load, both must be set to the same RS-232 settings. These communication settings are:

1. Baud rate: 4800,9600,19200 and 38400 are selectable, default setting is 9600.
2. Data bit: 8 bit
3. Stop bit: 1
4. Parity: None
5. Address: the range is from 0 to 31, default setting is 0

Start Bit	8 Data Bits	Parity=None	Stop Bit
-----------	-------------	-------------	----------

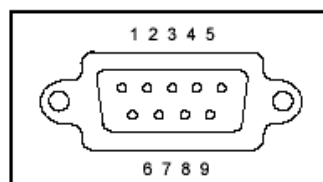

### RS-232

IT8513B+/IT8514B+/IT8514C+/IT8516C+ electronic load has a DB9 interface on rear panel. Connect E-load and computer by cable of COM ends (DB9). Composite key **[Shift] + [8]** on front board can be used to enter system menu for activation.

- RS-232 Interface

In RS-232 interface, all SCPI commands can be used for programming. If RS-232 interface is selected, in accordance with internal connection of data terminal equipment (DTE) and data communication equipment (DCE) as defined in EIA RS-232, the load is connected to another DTE (e.g., PC COM interface) with direct-connected Modem cable.

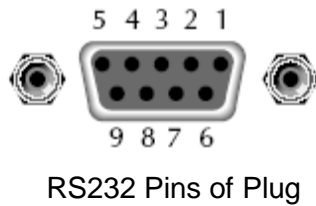

Base Pin Number	Description
1	No conjunction
2	TXD, data transmission
3	RXD, data receiving
4	No conjunction
5	GND, grounding
6	No conjunction
7	CTS, clear to send
8	RTS, request to send
9	No conjunction

- Communication Setup

Please ensure the PC and the load have the same configuration in the following items.

Baudrate: 9600(4800, 9600, 19200, 38400). You could enter the system menu to set the baudrate.

Data bit: 8

Stop bit: 1

Parity bit: (none, even, odd)

**EVEN 8 data bits have even parity**

**ODD 8 data bits have odd parity**

**NONE 8 data bits have no parity**

Native machine address: (0 ~31, factory default is 0)

Start Bit	8 Data Bits	Parity=None	Stop Bit
-----------	-------------	-------------	----------

## USB Interface

Connect the load and the computer using a cable with two USB interfaces (each end). All functions of the load can be programmed via USB.

After connecting the load and computer by USB, you need to install IT-E122 driver (download from

<http://www.itech.sh/support/Down-3.htm?model=IT-E122%20%E5%85%89%E9%9A%94%E7%A6%BB%E9%80%9A%E8%AE%AF%E6%8E%A5%E5%8F%A3%E9%A9%B1%E5%8A%A8> or contact ITECH agent). The device manager of PC will display 'Prolific USB-to-Serial COM Port' after installing.

Notes: Only IT8513B+/IT8514B+/IT8514C+/IT8516C+ models have the USB communication interface. After the driver is installed successfully, use USB line to connect in communication. (Please don't connect DB9 interface at the same time). Don't need to set the menu.

## Appendix

### Specifications of Red and Black Test Lines

ITECH provides you with optional red and black test lines, which individual sales and you can select for test. For specifications of ITECH test lines and maximum current values, refer to the table below.

Model	Specification	Cross Section	Length
IT-E301/10A	10A	-	1m
IT-E301/30A	30A	6mm <sup>2</sup>	1.2m
IT-E301/30A	30A	6mm <sup>2</sup>	2m
IT-E301/60A	60A	20mm <sup>2</sup>	1.5m
IT-E301/120A	120A	50mm <sup>2</sup>	2m
IT-E301/240A	240A	70mm <sup>2</sup>	1m
IT-E301/240A	240A	70mm <sup>2</sup>	2m
IT-E301/360A	360A	95mm <sup>2</sup>	2m

For maximum current of AWG copper wire, refer to table blow.

AWG	10	12	14	16	18	20	22	24	26	28
The Maximum Current Value( A)	40	25	20	13	10	7	5	3.5	2.5	1.7

**Note:** AWG ( American Wire Gage), it means X wire ( marked on the wire). The table above lists current capacity of single wire at working temperature of 30°C. For reference only.

## **Contact Us**

Thanks for purchasing ITECH products. In case of any doubts, please contact us as follows:

1. Refer to accompanying data disk and relevant manual.
2. Visit ITECH website: [www.itechate.com](http://www.itechate.com).
3. Select the most convenient contact method for further information.