

This Quick Start Guide is provided so that you can properly set up your new TV.

## 1 PACKAGE CONTENT

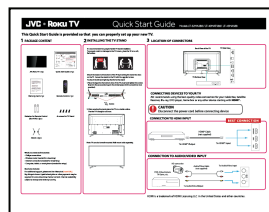

JVC Roku TV x 1pc



Quick Start Guide x 1pc



Warranty Card x 1pc



Remote Control x 1pc



Batteries for Remote Control (Size AAA) x 2pcs



4x screws for TV Stand



Stands x 2pcs

### What you need (not included)

- Phillips screw driver
- Wireless router (needed for streaming)
- Internet connection (needed for streaming)
- Computer, tablet, or smart phone (needed for setup)

For additional support, please refer to User Manual and JVC Customer Support at

<http://go.roku.com/tvmanual>

<http://jvcproducts.com/>

Key things to know: A paid subscription or other payments may be required for some streaming channel content. Channel availability subject to change and varies by country.

Payment required for some channels and content. 4K and HDR require 4K and HDR content, is not available on all channels and is subject to channel provider bandwidth requirements. Channels are subject to change and vary by region.

## 2 INSTALLING THE TV STAND

It is recommended two people handle TV stand installation. To prevent scratch or damage to the TV screen, place the TV on a soft, flat surface.

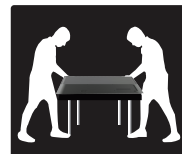

Attach the stands to the bottom of the TV by inserting the stand into slots on the TV. Secure the stands to the TV with the supplied screws.

To attach the left and right leg that forms the stand:

1. Place the legs into the bottom slots of the TV, insert and tighten the screws (found in the accessories bag) in the circled areas with the screwdriver (not provided).

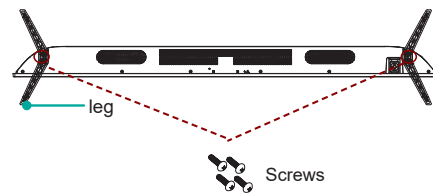

2. After securing the stand, place the TV on a stable surface. The TV is ready for use now.

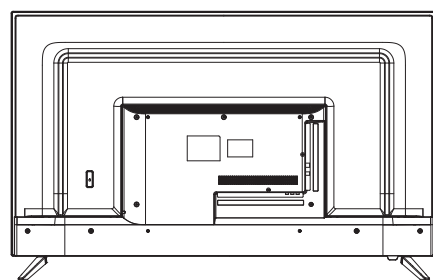

Note: TV can also be wall mounted. Wall mount sold separately.

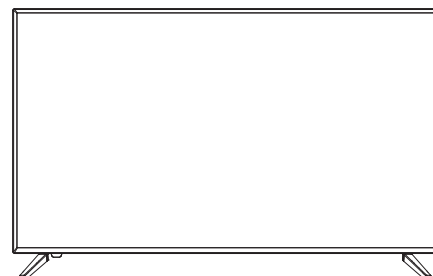

## 3 LOCATION OF CONNECTORS

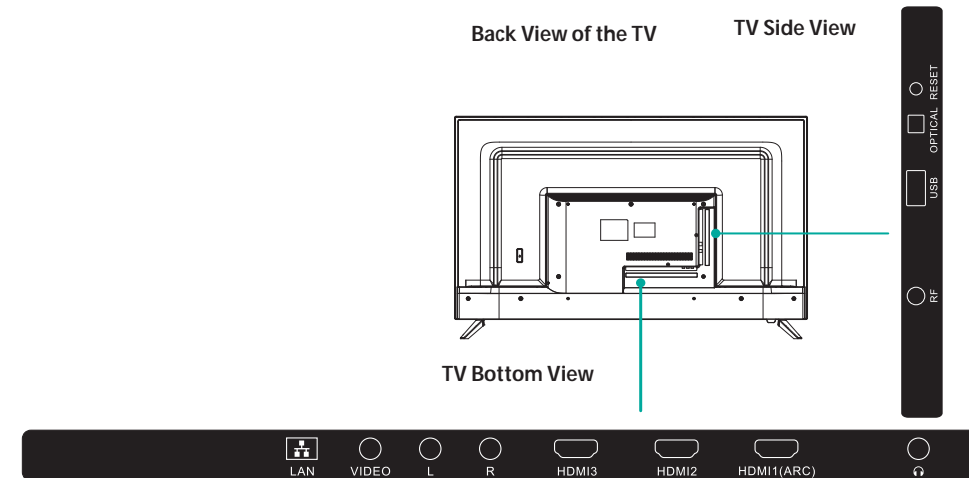

## 4 CONNECTING DEVICES TO YOUR TV

JVC recommends using the best-quality video connection for your Cable Box, Satellite Receiver, Blu-ray, DVD player, Game box or any other device starting with **HDMI®**.

**CAUTION**  
Disconnect the power cord before connecting device

### CONNECTION TO HDMI INPUT

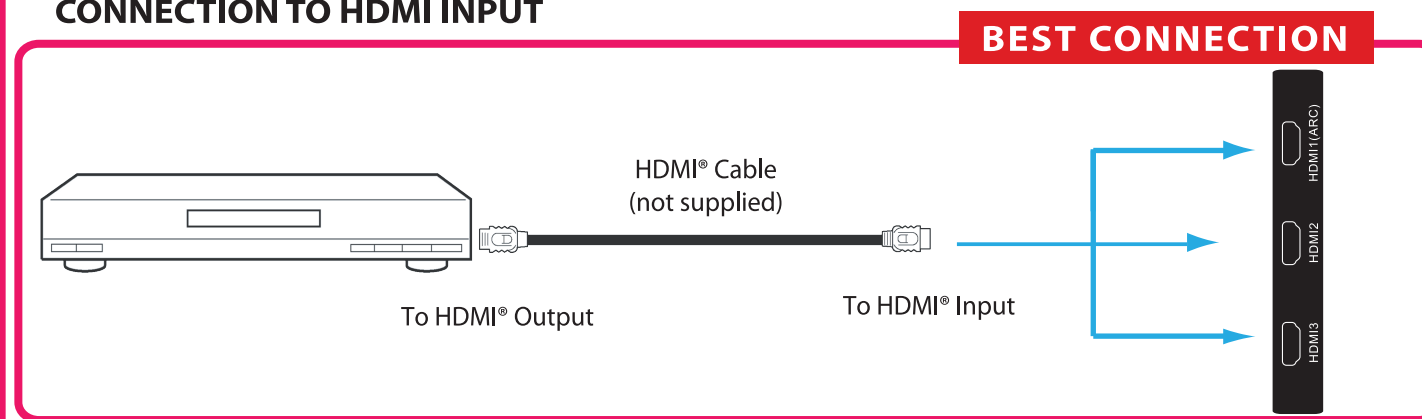

### CONNECTION TO AUDIO/VIDEO INPUT

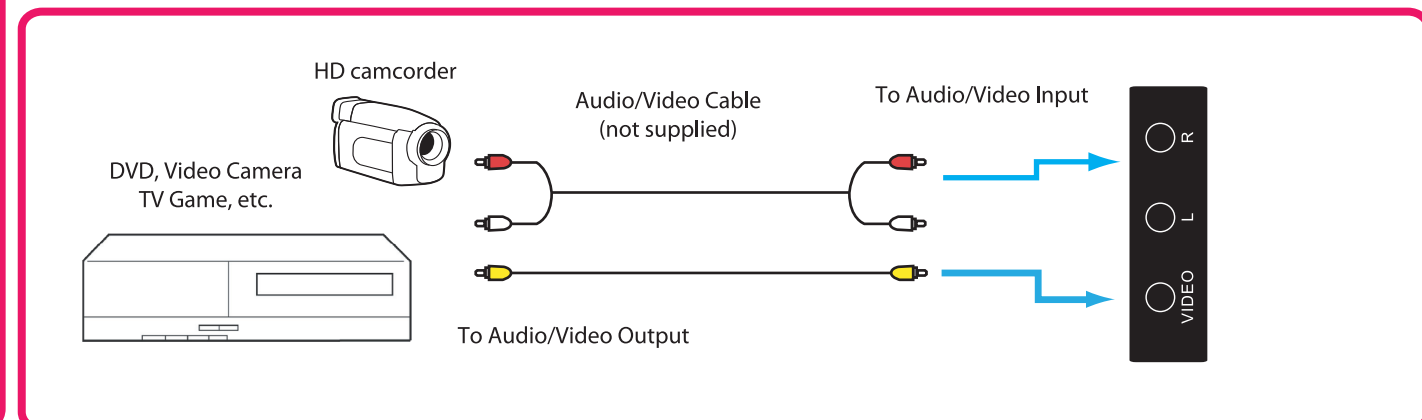

4010Q50A019



The Adopted Trademarks HDMI, HDMI High-Definition Multimedia Interface, and the HDMI Logo are trademarks or registered trademarks of HDMI Licensing Administrator, Inc. in the United States and other countries.

## 5 SETTING UP YOUR TV

### 1. Place batteries in remote

Power your TV remote by inserting the included batteries carefully matching (+) and (-) indicated inside the battery compartment.

Tip: Always replace dead batteries with two brand-new batteries from the same manufacturer. Never use damaged batteries.

If your remote gets warm/hot during use, discontinue use and contact customer support immediately at <https://jvcsmart.com/pages/contact>

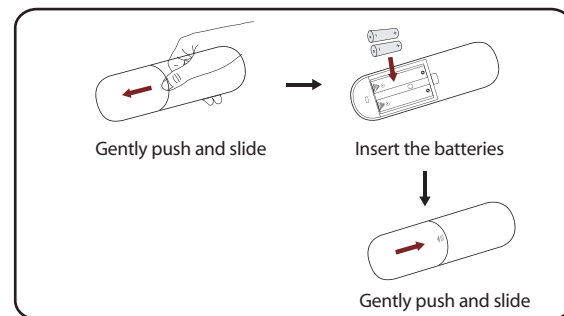

### 2. Plug in and turn on TV

Connect your power cord to the TV, then plug it into the wall outlet.

Press the power button on your TV remote control.

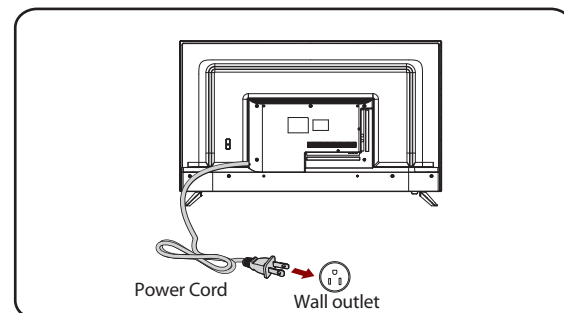

### 3. Complete Guided Setup and Activation

Tip: Have your wireless network name and password handy.

Follow the on-screen instructions on your Roku TV.

Activate your Roku TV using your computer, smartphone, or tablet to link to a Roku account. You need a Roku account to activate your Roku TV and access entertainment across thousands of streaming channels.

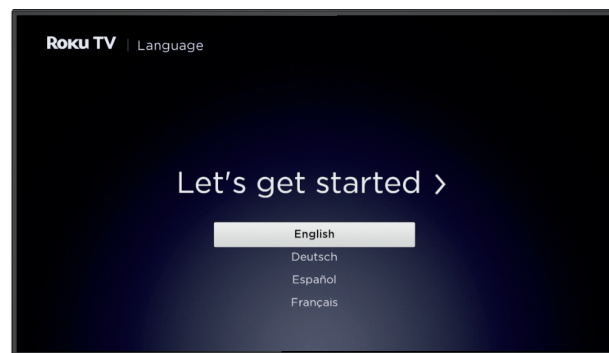

**Note:** Roku doesn't charge for activation support – **beware of scams.**

Roku accounts are free and while a valid credit card number is not required to create a Roku account, saving your credit card information makes renting, purchasing, and subscribing to entertainment from the Roku Channel Store fast and convenient.

Once connected to your account, your TV will automatically update with the latest software, and you can start streaming immediately.



If you aren't ready to connect your TV to a wireless network, you can still use it as a regular TV.

## 6 CONNECT AN ANTENNA (OPTIONAL)

Check to ensure that you have selected the right cables for the ports and that they are connected securely. Loose connections can affect the quality of the picture image and color. (Cables and External Equipment not included.)

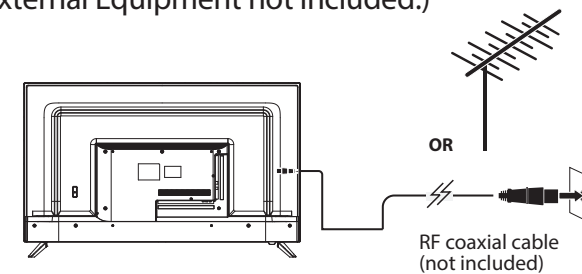

Note:  
Aerial connections : F connector.  
Input impedance : 75Ω unbalanced.

With the tuner built-in you can connect your TV to an antenna and enjoy over-the-air entertainment.

1. When the setup wizard is complete select the Antenna TV icon  from the home screen.
2. Follow the on-screen instructions.
3. Whenever you want to watch antenna TV, select the Antenna icon.

## 7 REMOTE CONTROL

The Roku TV remote should feel right at home in your hand. We designed it to be incredibly intuitive for watching TV and navigating on-screen menus.

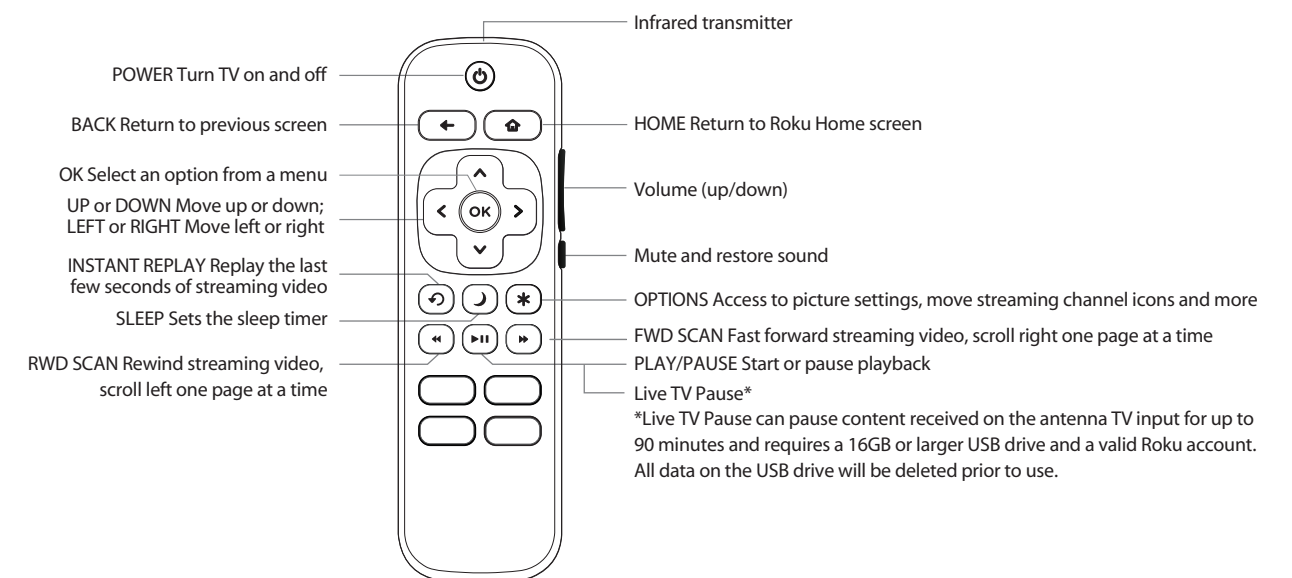

Tip: The  gives you easy access to picture settings, display options and more. Try it on every screen.

Tip: If you prefer to use your cable set-top box or satellite receiver remote as a Universal Remote, please refer to the manual that your cable or satellite service provided. It includes instructions on how to program their remote to your television. You can find codes that work with your JVC Roku TV and most common cable and satellite provider's universal remote controls at [www.roku.com/universalremote](http://www.roku.com/universalremote).