

KEITHLEY

Model 197A Autoranging Microvolt DMM

User's Manual

A GREATER MEASURE OF CONFIDENCE

WARRANTY

Keithley Instruments, Inc. warrants this product to be free from defects in material and workmanship for a period of 1 year from date of shipment.

Keithley Instruments, Inc. warrants the following items for 90 days from the date of shipment: probes, cables, rechargeable batteries, diskettes, and documentation.

During the warranty period, we will, at our option, either repair or replace any product that proves to be defective.

To exercise this warranty, write or call your local Keithley representative, or contact Keithley headquarters in Cleveland, Ohio. You will be given prompt assistance and return instructions. Send the product, transportation prepaid, to the indicated service facility. Repairs will be made and the product returned, transportation prepaid. Repaired or replaced products are warranted for the balance of the original warranty period, or at least 90 days.

LIMITATION OF WARRANTY

This warranty does not apply to defects resulting from product modification without Keithley's express written consent, or misuse of any product or part. This warranty also does not apply to fuses, software, non-rechargeable batteries, damage from battery leakage, or problems arising from normal wear or failure to follow instructions.

THIS WARRANTY IS IN LIEU OF ALL OTHER WARRANTIES, EXPRESSED OR IMPLIED, INCLUDING ANY IMPLIED WARRANTY OF MERCHANTABILITY OR FITNESS FOR A PARTICULAR USE. THE REMEDIES PROVIDED HEREIN ARE BUYER'S SOLE AND EXCLUSIVE REMEDIES.

NEITHER KEITHLEY INSTRUMENTS, INC. NOR ANY OF ITS EMPLOYEES SHALL BE LIABLE FOR ANY DIRECT, INDIRECT, SPECIAL, INCIDENTAL OR CONSEQUENTIAL DAMAGES ARISING OUT OF THE USE OF ITS INSTRUMENTS AND SOFTWARE EVEN IF KEITHLEY INSTRUMENTS, INC., HAS BEEN ADVISED IN ADVANCE OF THE POSSIBILITY OF SUCH DAMAGES. SUCH EXCLUDED DAMAGES SHALL INCLUDE, BUT ARE NOT LIMITED TO: COSTS OF REMOVAL AND INSTALLATION, LOSSES SUSTAINED AS THE RESULT OF INJURY TO ANY PERSON, OR DAMAGE TO PROPERTY.



Keithley Instruments, Inc. • 28775 Aurora Road • Cleveland, OH 44139 • 440-248-0400 • Fax: 440-248-6168 • <http://www.keithley.com>

BELGIUM:	Keithley Instruments B.V.	Bergensesteenweg 709 • B-1600 Sint-Pieters-Leeuw • 02/363 00 40 • Fax: 02/363 00 64
CHINA:	Keithley Instruments China	Yuan Chen Xin Building, Room 705 • 12 Yumin Road, Dewai, Madian • Beijing 100029 • 8610-62022886 • Fax: 8610-62022892
FRANCE:	Keithley Instruments Sarl	3, allée des Garays • 91127 Palaiseau Cedex • 01-64 53 20 20 • Fax: 01-60 11 77 26
GERMANY:	Keithley Instruments GmbH	Landsberger Strasse 65 • 82110 Germering • 089/84 93 07-40 • Fax: 089/84 93 07-34
GREAT BRITAIN:	Keithley Instruments Ltd	The Minster • 58 Portman Road • Reading, Berkshire RG30 1EA • 0118-9 57 56 66 • Fax: 0118-9 59 64 69
INDIA:	Keithley Instruments GmbH	Flat 2B, WILOCRISSA • 14, Rest House Crescent • Bangalore 560 001 • 91-80-509-1320/21 • Fax: 91-80-509-1322
ITALY:	Keithley Instruments s.r.l.	Viale S. Gimignano, 38 • 20146 Milano • 02-48 39 16 01 • Fax: 02-48 30 22 74
NETHERLANDS:	Keithley Instruments B.V.	Postbus 559 • 4200 AN Gorinchem • 0183-635333 • Fax: 0183-630821
SWITZERLAND:	Keithley Instruments SA	Kriesbachstrasse 4 • 8600 Dübendorf • 01-821 94 44 • Fax: 01-820 30 81
TAIWAN:	Keithley Instruments Taiwan	1 Fl. 85 Po Ai Street • Hsinchu, Taiwan, R.O.C. • 886-3572-9077 • Fax: 886-3572-903

Model 197A Autoranging Microvolt DMM User's Manual

©1990, Keithley Instruments, Inc.
All rights reserved.
Cleveland, Ohio, U.S.A.
Third Printing, February 2001
Document Number: 197A-901-01 Rev. C

SAFETY PRECAUTIONS

The following safety precautions should be observed before operating the Model 197A.

This instrument is intended for use by qualified personnel who recognize shock hazards and are familiar with the safety precautions required to avoid possible injury. Read over the manual carefully before operating this instrument.

Exercise extreme caution when a shock hazard is present at the instrument's input. The American National Standards Institute (ANSI) states that a shock hazard exists when voltage levels greater than 30V rms or 42.4V peak are present. **A good safety practice is to expect that a hazardous voltage is present in any unknown circuit before measuring.**

Inspect the test leads for possible wear, cracks or breaks before each use. If any defects are found, replace the test leads.

For optimum safety do not touch the test leads or the instrument while power is applied to the circuit under test. Turn the power off and discharge all capacitors, before connecting or disconnecting the instrument.

Do not touch any object which could provide a current path to the common side of the circuit under test or power line (earth) ground. Always make measurements with dry hands while standing on a dry, insulated surface, capable of withstanding the voltage being measured.

Exercise extreme safety when testing high energy power circuits (AC line or mains, etc). Refer to High Energy Circuit Safety Precautions found in paragraph 2.2.

Do not exceed the instrument's maximum allowable input as defined in the specifications and operation section.

Instrumentation and accessories should not be connected to humans.

Safety Precautions

The following safety precautions should be observed before using this product and any associated instrumentation. Although some instruments and accessories would normally be used with non-hazardous voltages, there are situations where hazardous conditions may be present.

This product is intended for use by qualified personnel who recognize shock hazards and are familiar with the safety precautions required to avoid possible injury. Read the operating information carefully before using the product.

The types of product users are:

Responsible body is the individual or group responsible for the use and maintenance of equipment, for ensuring that the equipment is operated within its specifications and operating limits, and for ensuring that operators are adequately trained.

Operators use the product for its intended function. They must be trained in electrical safety procedures and proper use of the instrument. They must be protected from electric shock and contact with hazardous live circuits.

Maintenance personnel perform routine procedures on the product to keep it operating, for example, setting the line voltage or replacing consumable materials. Maintenance procedures are described in the manual. The procedures explicitly state if the operator may perform them. Otherwise, they should be performed only by service personnel.

Service personnel are trained to work on live circuits, and perform safe installations and repairs of products. Only properly trained service personnel may perform installation and service procedures.

Keithley products are designed for use with electrical signals that are rated Installation Category I and Installation Category II, as described in the International Electrotechnical Commission (IEC) Standard IEC 60664. Most measurement, control, and data I/O signals are Installation Category I and must not be directly connected to mains voltage or to voltage sources with high transient over-voltages. Installation Category II connections require protection for high transient over-voltages often associated with local AC mains connections. The user should assume all measurement, control, and data I/O connections are for connection to Category I sources unless otherwise marked or described in the Manual.

Exercise extreme caution when a shock hazard is present. Lethal voltage may be present on cable connector jacks or test fixtures. The American National Standards Institute (ANSI) states that a shock hazard exists when voltage levels greater than 30V RMS, 42.4V peak, or 60VDC are present. **A good safety practice is to expect that hazardous voltage is present in any unknown circuit before measuring.**

Users of this product must be protected from electric shock at all times. The responsible body must ensure that users are prevented access and/or insulated from every connection point. In some cases, connections must be exposed to potential human contact. Product users in these circumstances must be trained to protect themselves from the risk of electric shock. If the circuit is capable of operating at or above 1000 volts, **no conductive part of the circuit may be exposed.**

Do not connect switching cards directly to unlimited power circuits. They are intended to be used with impedance limited sources. NEVER connect switching cards directly to AC mains. When connecting sources to switching cards, install protective devices to limit fault current and voltage to the card.

Before operating an instrument, make sure the line cord is connected to a properly grounded power receptacle. Inspect the connecting cables, test leads, and jumpers for possible wear, cracks, or breaks before each use.

When installing equipment where access to the main power cord is restricted, such as rack mounting, a separate main input power disconnect device must be provided, in close proximity to the equipment and within easy reach of the operator.

For maximum safety, do not touch the product, test cables, or any other instruments while power is applied to the circuit under test. ALWAYS remove power from the entire test system and discharge any capacitors before: connecting or disconnecting cables or jumpers, installing or removing switching cards, or making internal changes, such as installing or removing jumpers.

Do not touch any object that could provide a current path to the common side of the circuit under test or power line (earth) ground. Always make measurements with dry hands while standing on a dry, insulated surface capable of withstanding the voltage being measured.

The instrument and accessories must be used in accordance with its specifications and operating instructions or the safety of the equipment may be impaired.

Do not exceed the maximum signal levels of the instruments and accessories, as defined in the specifications and operating information, and as shown on the instrument or test fixture panels, or switching card.

When fuses are used in a product, replace with same type and rating for continued protection against fire hazard.

Chassis connections must only be used as shield connections for measuring circuits, NOT as safety earth ground connections.

If you are using a test fixture, keep the lid closed while power is applied to the device under test. Safe operation requires the use of a lid interlock.

If a  screw is present, connect it to safety earth ground using the wire recommended in the user documentation.

The  symbol on an instrument indicates that the user should refer to the operating instructions located in the manual.

The  symbol on an instrument shows that it can source or measure 1000 volts or more, including the combined effect of normal and common mode voltages. Use standard safety precautions to avoid personal contact with these voltages.

The **WARNING** heading in a manual explains dangers that might result in personal injury or death. Always read the associated information very carefully before performing the indicated procedure.

The **CAUTION** heading in a manual explains hazards that could damage the instrument. Such damage may invalidate the warranty.

Instrumentation and accessories shall not be connected to humans.

Before performing any maintenance, disconnect the line cord and all test cables.

To maintain protection from electric shock and fire, replacement components in mains circuits, including the power transformer, test leads, and input jacks, must be purchased from Keithley Instruments. Standard fuses, with applicable national safety approvals, may be used if the rating and type are the same. Other components that are not safety related may be purchased from other suppliers as long as they are equivalent to the original component. (Note that selected parts should be purchased only through Keithley Instruments to maintain accuracy and functionality of the product.) If you are unsure about the applicability of a replacement component, call a Keithley Instruments office for information.

To clean an instrument, use a damp cloth or mild, water based cleaner. Clean the exterior of the instrument only. Do not apply cleaner directly to the instrument or allow liquids to enter or spill on the instrument. Products that consist of a circuit board with no case or chassis (e.g., data acquisition board for installation into a computer) should never require cleaning if handled according to instructions. If the board becomes contaminated and operation is affected, the board should be returned to the factory for proper cleaning/servicing.

197A 5½-Digit Multimeter Specifications

DC VOLTS

RANGE	RESOLUTION	INPUT RESISTANCE	ACCURACY** ±(%rdg + counts)	
			24 Hr.,* 22°-24°C	1 Year, 18°-28°C
200 mV	1 µV	>1 GΩ	0.007 + 2	0.016 + 3
2 V	10 µV	>1 GΩ	0.005 + 2	0.011 + 2
20 V	100 µV	11 MΩ	0.006 + 2	0.015 + 3
200 V	1 mV	10 MΩ	0.006 + 2	0.015 + 2
1000 V	10 mV	10 MΩ	0.007 + 2	0.015 + 2

*Relative to calibration accuracy. **When properly zeroed.

NMR: >60dB at 50Hz, 60Hz ±0.1%.

MAXIMUM ALLOWABLE INPUT: 1000V DC or peak AC (<10 seconds per minute on 200mV and 2V ranges; 300V rms continuous).

SETTLING TIME: 1 second to within 3 counts of final reading on range.

dB MODE (ref: 600Ω): Accuracy: ±(0.02dB+1 count) above -78dBm.

RESOLUTION: 0.01dB above 0.7% of range.

dB REFERENCE IMPEDANCE: 50, 75, 93, 135, 300, or 600 ohms (default), front panel selectable.

DC AMPS

RANGE	RESOLUTION	MAXIMUM VOLTAGE BURDEN	ACCURACY (1 Year) 18°-28°C ±(%rdg + counts)
200 µA	1 nA	0.3 V	0.1 + 15
2 mA	10 nA	0.3 V	0.1 + 15
20 mA	100 nA	0.3 V	0.1 + 15
200 mA	1 µA	0.3 V	0.2 + 15
2000 mA	10 µA	0.8 V	0.2 + 15
10 A	100 µA	0.3 V	0.5 + 15*

*Above 5A derate 0.15% rdg per amp for self-heating.

OVERLOAD PROTECTION: mA Input: 2A fuse (250V), externally accessible. 10A Input: 20A for 15s, unfused.

SETTLING TIME: 1 second to within 3 counts of final reading.

ANALOG/IEEE OUTPUT (Model 1972A Option)

ANALOG OUTPUT:

Accuracy: ±(0.25% of displayed reading + 2mV).

Response Time: Follows display conversion rate.

Level: 1V=100,000 counts on ×1 gain. 1V=100 counts on ×1000 gain.

Maximum output voltage = 4V.

Output Resistance: 1000Ω.

Isolation: 500V peak, Input LO to Output LO.
30V peak, Output LO to earth ground.

IEEE OUTPUT: See IEEE BUS IMPLEMENTATION.

IEEE BUS IMPLEMENTATION

(1972A ANALOG/IEEE & 1973A IEEE OPTIONS)

MULTILINE COMMANDS: DCL, SDC, GET, GTL, UNT, UNL, SPE, SPD.

UNILINE COMMANDS: IFC, REN, BOI, SRQ, ATN.

INTERFACE FUNCTIONS: SH1, AHI, T5, TE0, L4, LEO, SRJ, RLO, PPO, DC1, DT1, C0, E1.

PROGRAMMABLE PARAMETERS: Range, REL, dB, EOI, Trigger, Calibration, SRQ, Status, Output Format, Terminator, Data Logger Retrieval.

TRMS AC VOLTS

RANGE	20Hz-50Hz	50Hz-10kHz	ACCURACY (1 Year)* 18°-28°C ±(%rdg + counts)		
			10kHz-20kHz	20kHz-50kHz	50kHz-100kHz
200 mV	1.00 + 100	0.35 + 100	0.6 + 200	1.5 + 250	5 + 400
2V-200V	1.00 + 100	0.35 + 100	0.6 + 200	1.5 + 250	3 + 400
750 V	1.25 + 100	0.5 + 100	1.0 + 200	1.8 + 250	3 + 400

*Above 1800 counts. **Above 18000 counts.

MAXIMUM ALLOWABLE INPUT: 750V rms, 1000V peak (<10 seconds per minute on 200mV and 2V ranges; 300V rms continuous). 10V-Hz maximum.

3dB BANDWIDTH: 300kHz typical.

INPUT IMPEDANCE: 1MΩ paralleled by <75pF on 200V and 750V ranges; 1.1MΩ on 200mV, 2V, and 20V ranges. Capacitively coupled.

SETTLING TIME: 1 second to within 0.1% of final reading on range.

dB MODE (ref.: 600Ω)

RANGE	INPUT	ACCURACY (±dBm)			
		20Hz-10kHz	10kHz-20kHz	20kHz-50kHz	50kHz-100kHz
2V-750V	200 mV to 750 V (-12 to 59.8dBm)	0.18	0.18	0.28	0.50
200 mV	20 mV to 200 mV (-32 to -12dBm)	0.18	0.18	0.28	0.65
	2 mV to 20 mV (-52 to -32dBm)	0.85	1.10	2.00	---
	1 mV to 2 mV (-58 to -52dBm)	2.00	3.00	---	---

RESOLUTION: 0.01dBm above 0.5% of range.

dB REFERENCE IMPEDANCE: 50, 75, 93, 135, 300, or 600 ohms (default), front panel selectable.

TRMS AC AMPS

RANGE	MAX VOLTAGE BURDEN	ACCURACY (1 Year)* 18°-28°C ±(%rdg+counts)		
		20Hz-50Hz	50Hz-10kHz	10kHz-30kHz
200µA-20mA	0.3 V	1.0 + 100	0.8 + 100	2 + 250
200 mA	0.3 V	1.0 + 100	0.8 + 100	---
2000 mA	0.8 V	1.0 + 100	0.8 + 100	---
10 A	0.3 V	1.5 + 100	1.0 + 100**	---

*Above 1800 counts.

**1kHz max. Above 5A derate 0.15% rdg/amp for self-heating.

SETTLING TIME: 1 second to within 0.1% of final reading.

OHMS

RANGE	RESOLUTION	NOMINAL I-SHORT	OUTPUT MAX. V ACROSS UNKNOWN	ACCURACY ±(%rdg+counts)	
				24 Hr., 22°-24°C	1 Year, 18°-28°C
200 Ω	1 mΩ	2mA	0.5 V	0.01 + 2*	0.018 + 3*
2 kΩ	10 mΩ	2mA	4.0 V	0.01 + 2	0.018 + 2
20 kΩ	100 mΩ	400µA	4.0 V	0.014 + 2	0.026 + 2
200 kΩ	1 Ω	40µA	4.0 V	0.014 + 2	0.026 + 2
2 MΩ**	10 Ω	4µA	4.0 V	0.02 + 2	0.035 + 2
20 MΩ**	100 Ω	400nA	4.0 V	0.10 + 2	0.12 + 2
200 MΩ**	10 kΩ	400nA	5.0 V	2.00 + 1	2.00 + 1

*When properly zeroed. **Appropriate range selected automatically in MΩ.

CONFIGURATION: Automatic 2- or 4-terminal.

MAXIMUM ALLOWABLE INPUT: 450V DC or peak AC 10 seconds per minute. 350V rms continuous.

OPEN CIRCUIT VOLTAGE: +5V.

DIODE TEST: Display reads junction voltage up to 2.2V. Test Current: 1.6mA nominal.

SETTLING TIME: 2 seconds to within 3 counts of final reading on range.

GENERAL

DISPLAY: Backlit ±220,000-count LCD, 0.45 in height; polarity, function, range, and status indication.

RANGING: Auto or manual on DC volts, AC volts, and ohms; manual on AC amps and DC amps.

AUTORANGING TIME: 300ms per range average.

RELATIVE: Pushbutton allows zeroing of on range readings. Allows readings to be made with respect to baseline value. Front panel annunciator indicates REL mode.

DATA LOGGER and MIN/MAX: 100 reading storage capacity; records data at one of six selectable rates from 3 readings/second to 1 reading/hour or by manual triggering.

Also detects and stores maximum and minimum readings continuously while in data logger mode.

CONVERSION RATE: 3 readings/second.

OVERRANGE INDICATION: "OL" displayed.

CREST FACTOR (ratio of peak value to rms value), AC FUNCTIONS: 3.

MAXIMUM COMMON MODE VOLTAGE: 500V peak.

COMMON MODE REJECTION RATIO (1kΩ unbalance): >120dB at DC, 50Hz, 60Hz ±0.1%. >60dB in AC volts.

TEMPERATURE COEFFICIENT (0°-18°C & 28°-50°C): ±(0.1 × applicable one year accuracy specification) / °C.

ENVIRONMENT: Operating: 0°-50°C; <80% relative humidity up to 35°C; linearly derate 3% RH/°C. 35°-50°C. **Storage:** -40° to +70°C.

WARM-UP: 1 hour to rated accuracy.

POWER: 105-125V or 210-250V (external switch selected); 90-110V available; 50-60Hz, 12VA. Removable power cord. Optional 5 hour battery pack, Model 1978.

DIMENSIONS, WEIGHT: 89mm high × 235mm wide × 275mm deep (3½ in × 9¼ in × 10¾ in). Net weight 1.8kg (3 lb, 14 oz).

ACCESSORIES SUPPLIED: Model 1751 Safety Test Leads, instruction manual.

Table of Contents

SECTION 1 — General Information

1.1	INTRODUCTION	1-1
1.2	FEATURES	1-1
1.3	WARRANTY INFORMATION	1-2
1.4	MANUAL ADDENDA	1-2
1.5	SAFETY SYMBOLS AND TERMS	1-2
1.6	SPECIFICATIONS	1-2
1.7	UNPACKING AND INSPECTION	1-2
1.8	USING THE MODEL 197A MANUAL	1-2
1.9	INITIAL OPERATION	1-3
1.10	ACCESSORIES	1-3

SECTION 2 — Bench Operation

2.1	INTRODUCTION	2-1
2.2	HIGH ENERGY CIRCUIT SAFETY PRECAUTIONS	2-1
2.3	PREPARATION FOR USE	2-2
2.3.1	Line Power	2-2
2.3.2	Battery Pack Power	2-2
2.3.3	Battery Charging	2-2
2.4	FRONT AND REAR PANEL FAMILIARIZATION	2-2
2.4.1	Display	2-2
2.4.2	Front Panel Controls	2-4
2.4.3	Input Terminals	2-4
2.4.4	Current Fuse Replacement	2-4
2.4.5	Rear Panel Switches	2-5
2.5	ERROR MESSAGES	2-5
2.6	OPERATING CONDITIONS	2-5
2.6.1	Environmental Conditions	2-5
2.6.2	Maximum Allowable Inputs	2-5
2.6.3	Warm Up	2-6
2.7	BASIC BENCH MEASUREMENTS	2-6
2.7.1	Power Up	2-6
2.7.2	Relative Mode	2-6
2.7.3	DC Voltage Measurement	2-7
2.7.4	TRMS AC Voltage Measurements	2-8
2.7.5	Microvolt Measurement Considerations	2-8
2.7.6	Resistance Measurements	2-9
2.7.7	Current Measurements (DC or TRMS AC)	2-11
2.7.8	AC Plus DC Measurements	2-12
2.7.9	dB Measurements	2-13
2.7.10	dB Measurement Considerations and Applications	2-15
2.7.11	MIN/MAX and 100 Point Data Logger Operation	2-16
2.7.12	Diode Test	2-16

2.8	TRMS CONSIDERATIONS	2-17
2.8.1	AC Voltage Offset	2-17
2.8.2	TRMS Measurement Comparison	2-17
2.8.3	Crest Factor	2-17
2.8.4	Extended Frequency Response	2-17

SECTION 3 — Performance Verification

3.1	INTRODUCTION	3-1
3.2	ENVIRONMENTAL CONDITIONS	3-1
3.3	RECOMMENDED TEST EQUIPMENT	3-1
3.4	INITIAL CONDITIONS	3-1
3.5	VERIFICATION PROCEDURE	3-2
3.5.1	DC Voltage Accuracy Check	3-2
3.5.2	AC Voltage Accuracy Check	3-3
3.5.3	Resistance Accuracy Check	3-4
3.5.4	DC Current Accuracy Check	3-6
3.5.5	AC Current Accuracy Check	3-7

SECTION 4 — Maintenance

4.1	INTRODUCTION	4-1
4.2	DISASSEMBLY INSTRUCTIONS	4-1
4.3	BATTERY PACK (Model 1978) INSTALLATION	4-3
4.4	LINE VOLTAGE SELECTION	4-4
4.5	FUSE REPLACEMENT	4-5
4.5.1	Line Fuse Replacement	4-5
4.5.2	Current Fuse Replacement	4-5
4.6	FRONT PANEL CALIBRATION	4-5
4.6.1	Recommended Calibration Equipment	4-6
4.6.2	Environmental Conditions	4-6
4.6.3	Calibration Switch	4-6
4.6.4	DC Voltage Calibration	4-6
4.6.5	AC Voltage Calibration	4-7
4.6.6	Frequency Compensation	4-7
4.6.7	Resistance Calibration	4-9
4.6.8	Calibration Storage	4-10

List of Illustrations

SECTION 2 — Bench Operation

Figure 2-1	Model 197A Front Panel	2-3
Figure 2-2	Model 197A Rear Panel	2-3
Figure 2-3	DC Voltage Measurements	2-7
Figure 2-4	TRMS AC Voltage Measurements	2-8
Figure 2-5	Four Terminal Zeroing	2-10
Figure 2-6	Two Terminal Resistance Measurement	2-11
Figure 2-7	Four Terminal Resistance Measurement	2-11
Figure 2-8	Current Measurement Between 2000mA and 20A	2-12
Figure 2-9	Current Measurements up to 2000mA	2-12
Figure 2-10	Typical ACV Frequency Response	2-18

SECTION 3 — Performance Verification

Figure 3-1	Connections for DCV Verification	3-2
Figure 3-2	Connections for ACV Verification	3-4
Figure 3-3	Connections for 200 Ω , 2k Ω and 20k Ω Range Verification (4-terminal)	3-5
Figure 3-4	Connections for 200k Ω through M Ω Ranges Verification (2-terminal)	3-5
Figure 3-5	Connections for DC Current Verification (200 μ A to 2000mA)	3-6
Figure 3-6	Connections for DC Current Verification (2000mA to 20A)	3-7
Figure 3-7	Connections for AC Current Verification (200 μ A to 2000mA)	3-8
Figure 3-8	Connections for AC Current Verification (2000mA to 10A)	3-8

SECTION 4 — Maintenance

Figure 4-1	Model 197A Miscellaneous Parts	4-2
Figure 4-2	Display Assembly Exploded View	4-4
Figure 4-3	DC Voltage Calibration Configuration	4-7
Figure 4-4	AC Voltage Calibration Configuration	4-8
Figure 4-5	200, 2k and 20k Four Wire Resistance Calibration	4-9
Figure 4-6	200k, 2M and 20M Two Wire Resistance Calibration	4-10

List of Tables

SECTION 2 — Bench Operation

Table 2-1	Error Messages	2-5
Table 2-2	Model 197A Maximum Allowable Inputs	2-6
Table 2-3	Resistance Ranges	2-10
Table 2-4	dB Specifications for DC Volts (600 Ω Ref)	2-13
Table 2-5	dB Specifications for AC Volts (600 Ω Ref)	2-13
Table 2-6	Selectable Reference Impedances	2-13
Table 2-7	Levels for Other Reference Impedances	2-14
Table 2-8	Comparison of Average and TRMS Meter Readings	2-19

SECTION 3 — Performance Verification

Table 3-1	Equipment Specifications	3-2
Table 3-2	Limits for DC Voltage Verification	3-3
Table 3-3	Limits for AC Voltage Verification	3-3
Table 3-4	Limits for Resistance Verification	3-4
Table 3-5	Limits for DC Current Verification	3-7
Table 3-6	Limits for AC Current Verification	3-9

SECTION 4 — Maintenance

Table 4-1	Input Terminal Identification	4-3
Table 4-2	Recommended Calibration Equipment	4-6
Table 4-3	DC Voltage Calibration	4-7
Table 4-4	AC Voltage Calibration	4-9
Table 4-5	Resistance Calibration	4-9

SECTION 1

General Information

1.1 INTRODUCTION

The Model 197A is a six function, 5-1/2 digit resolution autoranging digital multimeter with a $\pm 220,000$ count LCD (Liquid Crystal Display). This A/D range is greater than the normal $\pm 199,999$ count A/D used in many 5-1/2 digit DMMs. The 5-1/2 digit resolution allows the Model 197A to measure DC voltage for $1\mu\text{V}/\text{count}$ to 1000V . AC voltage and current measurements are standard in the Model 197A. TRMS ACV capability ranges from $1\mu\text{V}/\text{count}$ to 750V . The Model 197A measures resistance from $1\text{m}\Omega$ to $220\text{M}\Omega$ on seven resistance ranges. The Model 197A has six current ranges that measure current from 1nA (10^{-9}A) to 10A .

The dB function makes it possible to compress a large range of readings into a much smaller scope. Model 197A dBm measurements can be referenced to 50, 75, 93, 135, 300 or 600Ω (default), but can be modified with the use of the relative (REL) feature.

The Model 197A has two IEEE-488 interface options: The Model 1972A and the Model 1973A. These optional interfaces enhance the capabilities of the Model 197A by allowing programmed control over the IEEE-488 bus. The Model 1972A also includes an analog output. The bus commands are the same for each interface and respond to IEEE-488 protocol.

1.2 FEATURES

The Model 197A includes the following features:

1. Six Measurement Functions — DCV, ACV, DCA, ACA, OHMS and dB all built in.
2. (REL) Relative Mode — The relative mode allows offsets to be nulled out (e.g. test lead resistance for low resistance measurements) and selects a variety of reference impedances for dB measurements.
3. Digital Calibration — A non-volatile RAM stores calibration constants and can be performed from the front panel or over the IEEE-488 bus.
4. Data Logger — A data storage buffer is included to allow up to 100 readings and minimum/maximum readings be internally stored at a user selectable rate. The buffer may be read and controlled from the front panel or over the IEEE-488 bus. In the talk-only mode, the output rate can also be programmed.
5. Autoranging — The Model 197A includes a fast autoranging feature for easier measurements.
6. 5-1/2 Digit Resolution — The Model 197A has a $\pm 220,000$ count A/D that surpasses the more common $\pm 199,999$ count A/D.
7. Four Terminal Ohms — These terminals are used to eliminate the voltage from across the current carrying leads.
8. Sensitivity — The Model 197A has $1\mu\text{V}$, $1\text{m}\Omega$ and 1nA sensitivity. The $1\mu\text{V}$ of sensitivity allows minute levels of offset, temperature etc. A 1nA sensitivity allows low current measurements without special equipment. Measure leakage, bias and offset cur-

rent. A $1\text{m}\Omega$ sensitivity allows easy low resistance measurements.

9. Electroluminescent Display Backlight — An electroluminescent display backlight is used to enhance the liquid crystal display under low light or dark conditions.
10. dB Reference Impedances — Selectable dB reference impedances of 50Ω , 75Ω , 93Ω , 135Ω , 300Ω and 600Ω (default).

1.3 WARRANTY INFORMATION

Warranty information may be found on the inside front cover of this manual. Should it become necessary to exercise the warranty, contact your Keithley representative or the factory to determine the proper course of action. Keithley Instruments maintains service facilities in the United States, United Kingdom and throughout Europe. Information concerning the application, operation or service of your instrument may be directed to the applications engineer at any of these locations. Check the inside front cover for addresses.

1.4 MANUAL ADDENDA

Information concerning improvements or changes to this instrument which occur after the printing of this manual will be found on an addendum sheet included with this manual. Be sure to review these changes before attempting to operate or service the instrument.

1.5 SAFETY SYMBOLS AND TERMS

The following safety symbols and terms are used in this manual or found on the Model 197A.

The symbol  on the instrument denotes the user should refer to the operating instructions in this manual.

The symbol  on the instrument denotes that a potential of 1000V or more may be present on the terminal(s). Standard safety practices should be observed when such dangerous levels are encountered.

The **WARNING** heading used in this manual explains dangers that could result in personal injury or death.

The **CAUTION** heading used in this manual explains hazards that could damage the instrument.

1.6 SPECIFICATIONS

Detailed Model 197A specifications may be found preceding the table of contents of this manual.

1.7 UNPACKING AND INSPECTION

The Model 197A Autoranging Microvolt DMM was carefully inspected, both electrically and mechanically before shipment. Upon receiving the instrument, carefully unpack all items from the shipping carton and check for any obvious signs of physical damage that may have occurred during transit. Report any damage to the shipping agent. Retain and use the original packing material in case reshipment is necessary. The following items are shipped with every Model 197A order:

- Model 197A Autoranging DMM
- Model 197A User's Manual
- Model 1751 Safety Shrouded Test Leads
- Additional accessories as ordered.

If an additional instruction manual is required, order the manual package (Keithley Part Number 197A-901-00). The manual package includes an instruction manual and any applicable addenda.

1.8 USING THE MODEL 197A MANUAL

This manual contains information necessary for operating and servicing the Model 197A Autoranging Microvolt DMM and the 1978 Rechargeable Battery Pack. This section of the manual contains general information and an initial operation procedure. The rest of the manual is organized as follows:

- Section 2 contains detailed bench operation information for the Model 197A.
- Section 3 contains the information needed to verify the accuracy of the Model 197A. Performance verification can be done upon receipt of the unit or whenever the basic accuracy of the instrument is in question.
- Section 4 contains information on maintenance and calibration for the Model 197A.

NOTE

The Models 1973A and 1972A IEEE-488 interfaces come supplied with their own manual.

1.9 INITIAL OPERATION

Perform the following steps in sequence to acquaint yourself with the basic operation of the Model 197A.

- Verify that the instrument was not damaged in transit, (see paragraph 1.7).
- Carefully read over all safety information (see Section 2 Basic Operation).
- Refer to paragraph 2.3 (Line Power) and set the line voltage switch. Connect the female end of the power cord to the AC receptacle on the rear of the Model 197A. Plug the other end of the line cord into a properly grounded receptacle. If the Model 1978 is installed, the charging circuit is activated.
- Acquaint yourself with the front panel controls as follows:
 1. Turn on the instrument using the ON/OFF button. All of the zeroes are briefly displayed.
 2. Connect the supplied test leads to the HI and LO input terminals. Connect the red test lead to the HI terminal and the black test lead to the LO terminal. Short the test leads together.
 3. Select AC volts and autoranging by pressing in the AC/DC, V, and AUTO buttons. The AC, AUTO, and mV annunciators are displayed. Pressing in any of the other range buttons activates manual ranging. This is indicated by the absence of the AUTO annunciator.
 4. Select DC volts by releasing (out position) the AC/DC button. V is still selected. The AC annunciator turns off.
 5. Select the autoranging OHMS by pressing in the AUTO, and Ω buttons. DC must still be selected. The Ω (omega) symbol is displayed. Press the AC/DC button in (means select AC) and note the "Err" message is displayed. This indicates an invalid mode.
 6. Select AC or DC current by setting the AC/DC button accordingly and pressing in the A button. The annunciator that reflects the selected mode is displayed. Note that current will not autorange. The 10A and LO terminals must be used on the 10A range.
 7. Select dB by selecting AC or DC volts and pressing the dB button. The dB annunciator will turn on and the default reference impedance (600 Ω) will be displayed momentarily. Pressing dB a sec-

ond time disables the dB measurement mode. To select an alternate dB reference impedance, enable dB as previously described, but hold in the dB button to scroll through the alternate impedance selections. Release the dB button when the desired dB reference impedance is displayed. When finished, again press dB to exit the dB mode.

8. The REL (relative) feature can be used with any measurement function: Volts, Amps, Ohms, or dB. For example, select the ohms function and autorange. The display reads approximately 000.140 Ω , which is the test lead resistance. Press the REL button. The REL annunciator is turned on and the display reads 000.000 Ω . The relative level of 000.14 Ω will be subtracted from all subsequent measurements. Press the REL button a second time to cancel the REL level.
9. To activate the 100 point DATA LOGGER with minimum/maximum, press and hold in the STO/CLR button. When the reading rate r=0 is displayed release the STO/CLR button. The STO annunciator turns on. Press the RCL button and the last data point is briefly displayed followed by the reading (data). Other data points can be displayed by holding in the RCL button. Turn off the DATA LOGGER by pressing the STO/CLR button again.

1.10 ACCESSORIES

The following accessories can be used with the Model 197A.

MODEL 1010 SINGLE RACK MOUNTING KIT — Used to mount one Model 197A in a standard 5-1/2" x 19" rack.

MODEL 1017 DUAL RACK MOUNTING KIT — Used to mount two Model 197As in a standard 5-1/4" x 19" rack.

MODEL 1301 TEMPERATURE PROBE — A rugged low cost temperature probe designed to allow precision temperature measurements from -55 to 150°C.

MODEL 1600A HIGH VOLTAGE PROBE — Extends DMM measurements to 40kV.

MODEL 1641 KELVIN TEST LEAD SET — Special clip leads allow 4-terminal measurements to be made while making only two connections.

SECTION 1

General Information

MODEL 1651 50-AMPERE CURRENT SHUNT — The external $0.001\Omega \pm 1\%$ 4-terminal shunt, permits current measurements from 0 to 50A AC or DC.

MODEL 1681 CLIP ON TEST LEAD SET — Contains two leads, 1.2m (48") long terminated with banana plugs and spring action clip probes.

MODEL 1682 RF PROBE — Permits voltage measurements from 10kHz to 250MHz. AC to DC transfer accuracy is $\pm 1\text{dB}$ from 100kHz to 250MHz at 1V, peak responding, calibrated in RMS of a sine wave.

MODEL 1684 HARD SHELL CARRYING CASE — Hard vinyl case, 100mm \times 300mm \times 350mm (4" \times 13" \times 14") has a fitted foam insert with room for the Model 197A, an instruction manual and small accessories.

MODEL 1685 CLAMP ON AC PROBE — Measure AC current by clamping on to a single conductor. Interruption of the circuit is unnecessary. The Model 1685 detects currents by sensing the changing magnetic produced by the current flow.

MODEL 1751 SAFETY TEST LEADS — This test lead set is supplied with every Model 197A. Finger guards and shrouded banana plugs help minimize the chance of making contact with live circuitry.

MODEL 1754 UNIVERSAL TEST LEAD KIT — A 12 piece test lead kit, with interchangeable plug-in accessories. Included in the kit is one set of test leads (1-red, 1-black), two spade lugs, two standard banana plugs, two phone tips

(.06 DIA.) two hooks and miniature alligator clips (with boots).

MODEL 1972A ANALOG OUTPUT IEEE-488 INTERFACE — The Model 1972A is an optional IEEE-488 interface that includes all of the logic necessary to interface the Model 197A to the IEEE-488 bus. The Model 1972A is similar to the Model 1973A however, it contains an analog output. The analog output is a scaled output that follows the display of the Model 197A. The Model 1972A is field installable.

MODEL 1973A IEEE-488 INTERFACE — The Model 1973A is an optional IEEE-488 interface for the Model 197A. This interface adds extra versatility to the Model 197A by allowing the transmission of data and commands over the IEEE-488 bus. The interface provides all the logic necessary to interface the Model 197A to the bus using standard IEEE-488-1978 protocol. The Model 1973A is field installable.

MODEL 1978 RECHARGEABLE BATTERY PACK — The rechargeable battery pack allows off line or in the field operation of the Model 197A. The pack typically provides five hours operation from full charge. The battery pack contains its own charging circuit and can be recharged within 15 hours. The battery pack is field installable.

MODEL 7008 IEEE-488 DIGITAL CABLE — Useful for connecting the 1973 to the IEEE-488 bus. The Model 7008-3 is 0.9m (3 ft.) in length and has a standard IEEE-488 connector at each end. The Model 7008-6 is 1.8m (6 ft.) in length and has a standard IEEE-488 connector at each end.

SECTION 2

Bench Operation

2.1 INTRODUCTION

This section contains the information needed to prepare and operate the Model 197A as a bench DMM. Bench operation consists of using the Model 197A to perform basic voltage, current, resistance and dB measurements. Also, the operation of the data logger is covered. The capabilities of the Model 197A can be enhanced with the addition of the Model 1973A or Model 1972A IEEE-488 interface. IEEE operation is covered in the Model 1973/1972 Manual. The optional battery pack (Model 1978) is also covered in this section.

2.2 HIGH ENERGY CIRCUIT SAFETY PRECAUTIONS

To optimize safety when measuring voltage in high energy distribution circuits, read and use the directions in the following warning.

WARNING

Dangerous arcs of an explosive nature in a high energy circuit can cause severe personal injury or death. If the meter is connected to a high energy circuit when set to a current range, low resistance range or any other low impedance range, the circuit is virtually shorted. Dangerous arcing can result even when the meter is set to a voltage range if the minimum voltage spacing is reduced.

When making measurements in high energy circuits use test leads that meet the following requirements:

- Test leads should be fully insulated.
- Only use test leads that can be connected to the circuit (e.g. alligator clips, spade lugs, etc.) for hands-off measurements.
- Do not use test leads that decrease voltage spacing. This diminishes arc protection and creates a hazardous condition.

Use the following sequence when testing power circuits:

1. De-energize the circuit using the regular installed connect-disconnect device such as the circuit breaker, main switch, etc.
2. Attach the test leads to the circuit under test. Use appropriate safety rated test leads for this application.
3. Set the DMM to the proper function and range.
4. Energize the circuit using the installed connect-disconnect device and make measurements without disconnecting the DMM.
5. De-energize the circuit using the installed connect-disconnect device.
6. Disconnect the test leads from the circuit under test.

CAUTION

The maximum common-mode input voltage (the voltage between input LO and chassis ground) is 500V peak. Exceeding this value may damage the instrument.

2.3 PREPARATION FOR USE

2.3.1 Line Power

The Model 197A has a three-wire line cord which mates with third-wire grounded receptacles. Connect the instrument to AC line power as follows:

1. Set the LINE VOLTAGE switch on the back of the instrument to correspond to line voltage available. Ranges are 105V-125V or 210V-250V 50/60Hz AC.

CAUTION

Be sure that the power line voltage agrees with the indicated range on the panel of the instrument. Failure to observe this precaution may result in instrument damage.

2. Connect the female end of the power cord to the AC receptacle on the rear panel of the Model 197A. Plug in the other end of the power cord into a properly grounded receptacle.

WARNING

The Model 197A is equipped with a 3-wire power cord that contains a separate ground wire and is designed to be used with grounded outlets. Failure to use a grounded outlet may result in personal injury or death because of electric shock.

2.3.2 Battery Pack Power

The Model 197A may be operated from rechargeable sealed nickel-cadmium batteries contained in the optional Model 1978 Rechargeable Battery Pack. The battery pack will operate the Model 197A for typically five hours. The BAT annunciator turns on when the charge is insufficient to maintain accurate readings.

2.3.3 Battery Charging

After the Model 1978 is installed in the Model 197A it can be charged and recharged as follows:

1. Connect the instrument to line power as described in paragraph 2.3.1.
2. The battery charge circuit is energized automatically when the instrument is plugged into the AC line. The rate at which the batteries charge is the same regardless

of the power switch state. When the battery pack is first installed, or if it is completely discharged, allow it to charge for a minimum of 15 hours.

NOTE

For maximum battery efficiency only charge the battery pack after it has become completely discharged (BAT annunciator on). Do not make measurements with BAT annunciator on as the readings may be erroneous.

If the battery pack is not maintaining a charge (BAT off) for five hours after a full 15 hour charge cycle, do the following.

- A. Disconnect the Model 197A from line power.
 - B. Turn on the Model 197A and leave it on to completely discharge the battery pack.
 - C. Connect the Model 197A to line power and charge the battery pack for 15 hours with power off.
 - D. Repeat steps A through C three more times. The battery pack should again be good for typically five hours.
3. When the Model 197A is in use on line power, the battery charger maintains a trickle charge on the battery pack.

NOTE

The IEEE options (Model 1972A and Model 1973A) do not run off of battery power.

2.4 FRONT AND REAR PANEL FAMILIARIZATION

Figure 2-1, Figure 2-2 and the following paragraphs, provide a brief description of the display, front panel controls, input terminals, and rear panel switches.

2.4.1 Display

The Model 197A has a 5-1/2 digit liquid crystal display (LCD). Positive polarity is implied by the absence of the minus (-) sign. The following annunciators are displayed on the LCD.

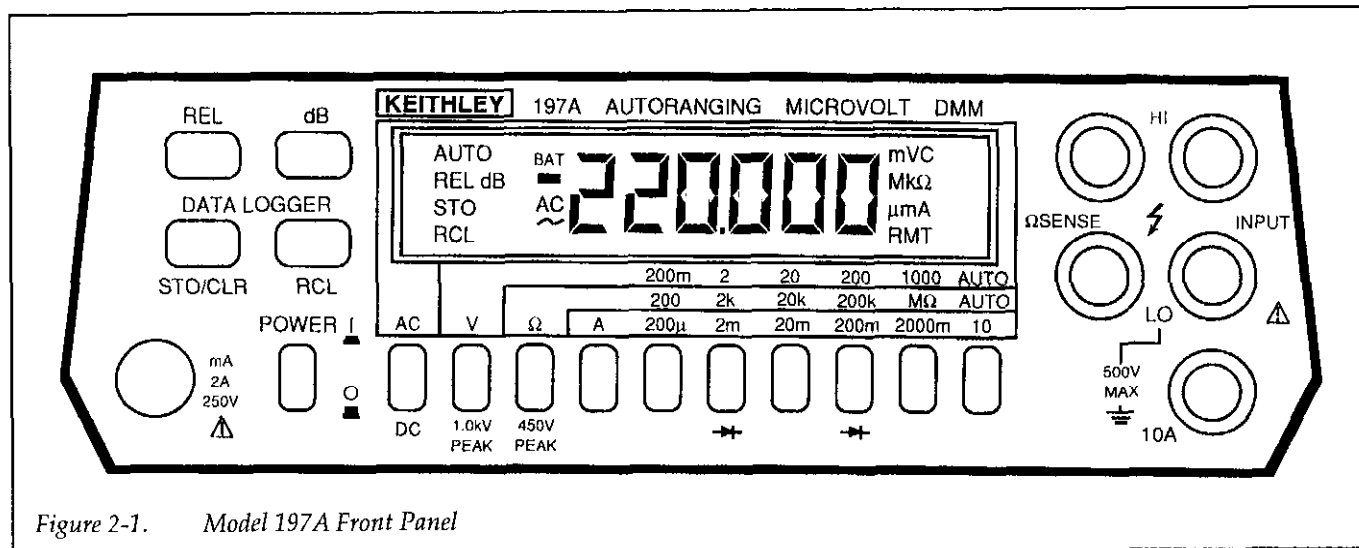

Figure 2-1. Model 197A Front Panel

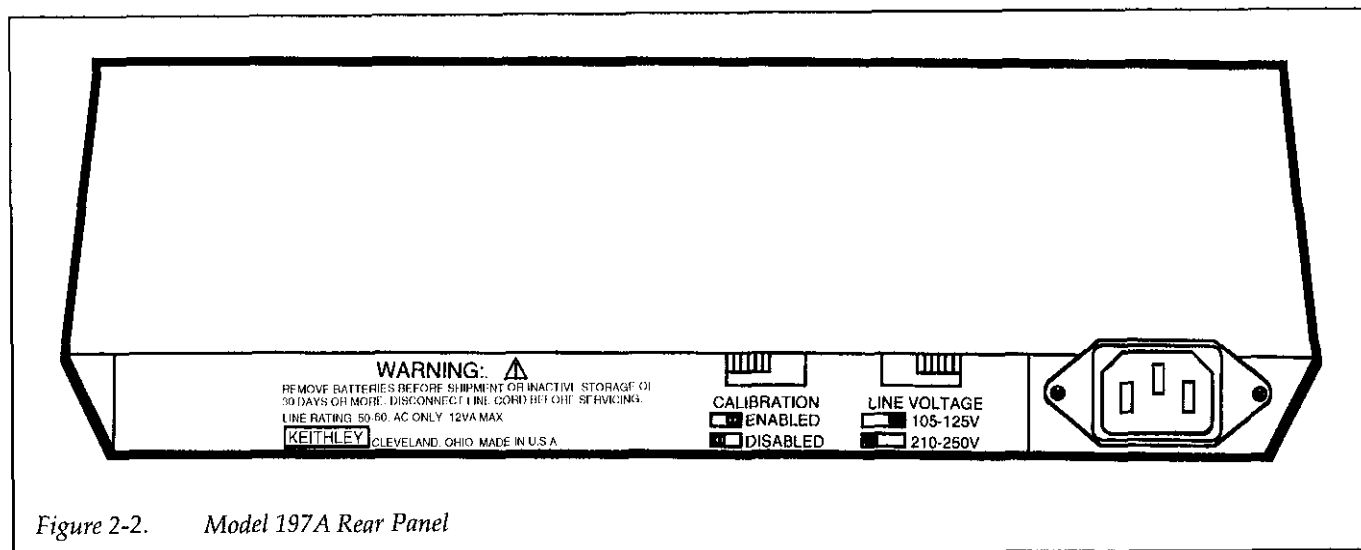

Figure 2-2. Model 197A Rear Panel

BAT — Low battery indicator for the Model 197A.

AC — AC selected (DC implied by the absence of the AC annunciator).

mV or V — Millivolts or volts.

Ω, kΩ or MΩ — Ohms, kilohms or megohms.

μ, mA or A — Microamps, milliamps or amps.

RMT (Remote) — Model 197A being controlled over the IEEE-488 bus (Model 1973A or Model 1972A installed).

C — Model 197A in calibration mode.

AUTO — Autorange.

REL — Relative.

dB — Decibel measurement mode.

STO — Data being stored.

RCL — Data being recalled. RCL flashes when buffer is full during logging cycle.

2.4.2 Front Panel Controls

ON/OFF — Pressing this button turns on the Model 197A. Releasing (out) this button turns the instrument off.

REL — (RELATIVE) — This button allows readings to be made with respect to any baseline value. Also allows detailed information on REL.

dB — This button selects the dB function and is used along with the ACV or DCV function. Measurements are made in dBm referenced to 50, 75, 93, 135, 300 or 600 Ω (default). REL can be used to make any voltage level the 0dB reference point for dB measurements.

DATA LOGGER and MIN/MAX — 100 reading storage capacity; records data at one of seven selectable rates from 3 reading/second to 1 reading/hour or by manual trigger (r=6). Also detects and stores maximum and minimum readings continuously while in the data logger mode.

1. STO/CLR — Pressing this button initiates the logging sequence. Pressing this button a second time turns off the data logger. For r=6 rate (manual trigger) every time a reading is desired, press the STO/CLR button.
2. RCL — Pressing and holding in this button scrolls the data pointer. To read the data at a certain point, simply release the button. The logged readings are stored in buffer locations 01 to 102. They are depicted on the front panel as follows: Buffer location #1 is represented by n=01.

AC/DC — This button is used along with the volts (V), current (A), and dB functions. Depressing (in) this button selects AC, releasing (out) this button selects DC. AC Ω is invalid condition. See Table 2-1.

V — Depressing this button selects the volts function.

Ω — Depressing this button selects the ohms function. The AC/DC button must be released (out).

A — Depressing (in) this button selects the current function. Up to 2A on red and black input jacks and up to 10A

with the black and white input jacks. Refer to paragraph 2.4.3.

RANGE BUTTONS

1. Depressing AUTO button allows volts and ohms to autorange. In current, it selects the 10A range. There is no autorange function for current.
2. Manual ranging is accomplished by depressing the appropriate range button.

2.4.3 Input Terminals

The input terminals are intended to be used with safety shrouded test leads to help minimize the possibility of contact with live circuits. Safety shrouded test leads (Model 1751) are supplied with the Model 197A. Always disconnect all unused test leads from the instrument.

HI and LO INPUT (Red and Black) — Use this pair of terminals for all volt, ohm, milliamp and dB measurements.

10A and LO (White and Black) — Use this pair of terminals for measuring current up to 10A (up to 20A for 15 seconds).

OHMS Sense HI and LO — Use this pair of terminals along with HI and LO input for four wire resistance measurements.

2.4.4 Current Fuse Replacement

The current fuse protects the 200 μ A through 2000mA ranges from an input current greater than 2A. To replace the current fuse, perform the following steps:

NOTE

The front panel current fuse (F101) is rated at 2A. With a 220,000 count display, the 2A range can momentarily (approx. one minute) read 2.2A before the fuse will blow. This 10% over-range will not harm the instrument.

1. Turn off the power and disconnect the power line and test leads.
2. Place the end of a flat-blade screwdriver into the slot in the fuse holder on the front panel. Press in slightly

and rotate the fuse carrier on quarter turn counterclockwise. Release pressure and remove the fuse carrier and the fuse.

- Remove the defective fuse and replace it with the following type: 2A, 250V, 3AG, normal-blow (Keithley part number FU-13) or equivalent.

CAUTION

Use only the recommended fuse type. If a fuse with a higher current rating is installed, instrument damage may occur.

2.4.5 Rear Panel Switches

The rear panel of the Model 197A is shown in Figure 2-2. Note that if an IEEE-488 interface module (Mode 1972A or 1973A) is installed, a modified top cover (provided with the interface) will be installed. The modified top cover has clearance holes in the rear panel to provide access to the interface connector(s) and switches. Refer to the Model 1973/1972 IEEE-488 Interface Instruction Manual for details.

CALIBRATION — This slide switch is used to enable or disable calibration of the Model 197A. In the ENABLED position, calibration constants can be stored. In the DISABLED position, newly entered calibration constants are lost when the instrument is turned off. During normal operation, keep this switch in the DISABLED position.

LINE VOLTAGE — This slide switch is used to match the instrument to the available line power voltage.

2.5 ERROR MESSAGES

Table 2-1 lists the error messages associated with basic front panel operation. Note that the instrument has a number of other messages that are discussed in the appropriate sections of the manual.

2.6 OPERATING CONDITIONS

2.6.1 Environmental Conditions

All measurements should be made at an ambient temperature within the range of 0°C to 50°C, and with a relative humidity of less than 80% up to 35°C. For ambient above 35°C derate humidity 3% per C up to 50°C. If the instrument has been subjected to extremes of temperatures, allow sufficient time for internal temperature to reach environmental conditions. Typically, it takes one hour to stabilize a unit that is 10°C (18°F) out of the specified temperature range.

2.6.2 Maximum Allowable Inputs

Table 2-2 lists the maximum allowable inputs for the Model 197A.

Table 2-1. Error Messages

Display	Message	Comments
	RAM Error	Model 197A locks up.
	Calibration Error (NVRAM Failure)	Model 197A locks up, but operation can be restored by pressing any one of the four momentary pushbuttons. If restored, calibration is invalid as indicated by the flashing "C" annunciator.
	Overrange	Overrange input applied to the Model 197A. Leading minus sign indicates that input signal has a negative value.
	Invalid Ω Function	"AC" and "Ω" annunciators flash. Correct problem by releasing (out) AC/DC pushbutton.

Table 2-2. Model 197A Maximum Allowable Inputs

Function	Ranges	Maximum Allowable Inputs
DCV	200mV, 2V 20-1000V	1000VDC or peak AC for less than 10sec per minute 300Vrms continuous. 1000VDC or peak AC.
ACV	200mV, 2V 20-750V	750Vrms, 1000V peak for less than 10sec per minute 300Vrms, continuous. 10 ⁷ •Hz maximum. 750Vrms, 1000V peak. 10 ⁷ •Hz maximum.
DCA, ACA	200μ-2000mA 10A	2A, 250VDC or rms (fuse protected). 10A continuous; 20A for 15sec (unfused).
Ω	All	450V peak AC or DC, 10 seconds per minute, 350Vrms continuous.

2.6.3 Warm Up

The Model 197A requires one hour for warm up to achieve rated accuracy.

CAUTION

Do not exceed the maximum input limits shown in Table 2-2.

2.7 BASIC BENCH MEASUREMENTS

Basic measurement techniques for using the Model 197A to measure AC and DC volts, resistance, AC and DC current and dB are covered in the following paragraphs. Also included is the operation of the minimum/maximum and 100 point data logger.

WARNING

Before operating the Model 197A, observe all previously mentioned safety precautions. When testing high energy power circuits follow the instructions found in paragraph 2.2. Failure to observe these and other safety precautions mentioned in this manual could result in severe injury or death.

The LO terminal on the Model 197A is designed to float above earth ground to avoid ground loop problems.

WARNING

Hazardous voltage may be applied to the LO terminal. The maximum allowable voltage between the LO terminal and chassis ground is 500V. Destruction of insulation, which could present a shock hazard, may occur if the 500V maximum is exceeded.

2.7.1 Power up

NOTE

The software revision level of the Model 197A can be displayed upon power up by running the diagnostic program.

Turn on the Model 197A by pressing in the ON/OFF switch. All zeroes are briefly displayed before going into the measurement mode.

2.7.2 Relative Mode

When the relative mode is selected with an on-scale reading on the display the following occurs:

1. The REL annunciator is displayed.
2. The next reading is stored.
3. This reading is algebraically subtracted from all subsequent readings and displayed.

A REL level can be established for any measurement function (Volts, Ohms, Amps and dB) and is effective only on that function. Changing functions will not affect a REL level already established. However, if another REL level is set (on any function) the previous REL level is cancelled. For example, place the Model 197A in the ohms function and select the 200Ω range. Short the test leads and press the REL button. Note that the REL annunciator is on. Select DCV and note that the REL annunciator is off, indicating that there is not a REL level established for DCV. Switch back to ohms and note that the REL level is still there. Again, go to DCV and set a REL level of +1V. The REL annunciator turns on. Switch back to ohms and note that the REL level for ohms is cancelled.

It is important to remember what the REL function does. The REL function establishes a baseline. That baseline is algebraically subtracted from all subsequent readings for that function.

Once a REL level is established for a measurement function, that stored level will be the same regardless of what range the Model 197A is on. For example, if +1V is established as the REL level on the 20VDC range, +1V is also the REL level for other DCV ranges.

The dynamic range of the display is $\pm 400,000$ counts. This means that if a REL level of $-2.00000V$ is established, then applying $+1.99999V$ to the input displays $+3.99999V$. Once the REL level is established, that level is algebraically subtracted from the input signal. For example: if a $+1.00000V$ REL level is established, then applying a $+2.00000V$ level displays a $+1.00000V$ level.

The instrument accepts a $\pm 220,000$ count input before going into the overrange condition (OL). For example: $-1.00000V$ REL level is established and $1.50000V$ is applied. The instrument displays $+2.500000V$. If the input is $2.20000V$ the instrument overranges.

2.7.3 DC Voltage Measurement

The Model 197A can make DC voltage measurements between $1\mu V$ and $1000V$. The basic procedure is as follows:

1. Connect the test leads to the HI and LO INPUT terminals of the Model 197A.
2. Select the DCV function.
3. Select a range consistent with the expected voltage. For automatic range selection, press in the AUTO button.

NOTE

To prolong instrument life, manual ranging is recommended for routine measurements above 200V.

4. Connect the test leads to the source as shown in Figure 2-3. If the positive source terminal is connected to the LO terminal of the instrument, the display shows a negative value. If the negative source terminal is connected to the LO terminal, the display shows a positive value.
5. Observe the display; If the "OL" message is shown, select a higher range until a normal reading is displayed. Always use the lowest possible range for the best resolution.
6. Take the reading from the display.

The term "when properly zeroed" means that the user must establish a proper baseline for subsequent measure-

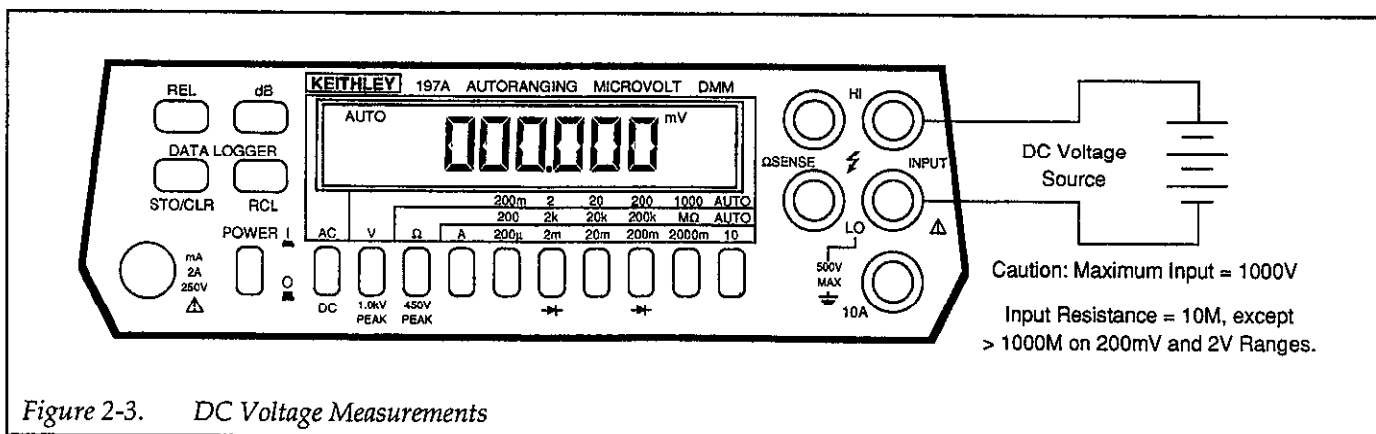

Figure 2-3. DC Voltage Measurements

ments on that range. To zero the Model 197A use the following procedure:

1. Short the INPUT HI and LO test leads together.
2. Wait until the display reading settles. Noise and thermal emfs may require a few moments to settle out.
3. Press the REL button.

The 200mV DC range and the 200Ω range require zero to be set in order to achieve rated accuracy.

2.7.4 TRMS AC Voltage Measurements

The Model 197A can make TRMS AC voltage measurements between 1μV and 750V. To measure AC proceed as follows:

1. Connect the test leads to the HI and LO terminals of the Model 197A.
2. Select the ACV function.
3. Select a range consistent with the expected voltage. For automatic range selection, press in the AUTO button.
4. Connect the test leads to the source as shown in Figure 2-4.

NOTE

There is a small amount of offset (typically 50 counts or less) present when using the AC function. Do not REL this level out. The reason for this is that the offset is generally negligible as compared to the input signal. For example:

$$\begin{aligned} \text{offset} &= 22\mu\text{V} \\ \text{applied signal} &= 20\text{mV} \\ \text{display reading} &= \sqrt{(20\text{mV})^2 + (22\mu\text{V})^2} \\ &= \sqrt{.0004 + 484 \times 10^{-12}} \\ &= .0200000121 \end{aligned}$$

This offset is seen as the last digit which is not displayed on the Model 197A. Therefore, the offset is negligible.

5. Observe the display, if the "OL" message is shown, select a higher range until a normal reading is displayed. Always use the lowest possible range to obtain the best resolution.
6. Take the reading from the display.

NOTE

See paragraph 2.8 for TRMS considerations. When measuring AC signals disconnect any test leads from the OHMS SENSE terminals.

2.7.5 Microvolt Measurement Considerations

Accuracy Considerations — For sensitive measurements, other external considerations besides the Model 197A will affect the accuracy. Effects not noticeable when working with higher voltages are significant in microvolt signals. The Model 197A reads only the signal received at its input; therefore, it is important that this signal be properly transmitted from the source. The following paragraphs indicate factors which affect accuracy, noise, source resistance, thermal emfs and stray pick-up.

Noise and Source Resistance — The limit of resolution in measuring voltages with the Model 197A is determined

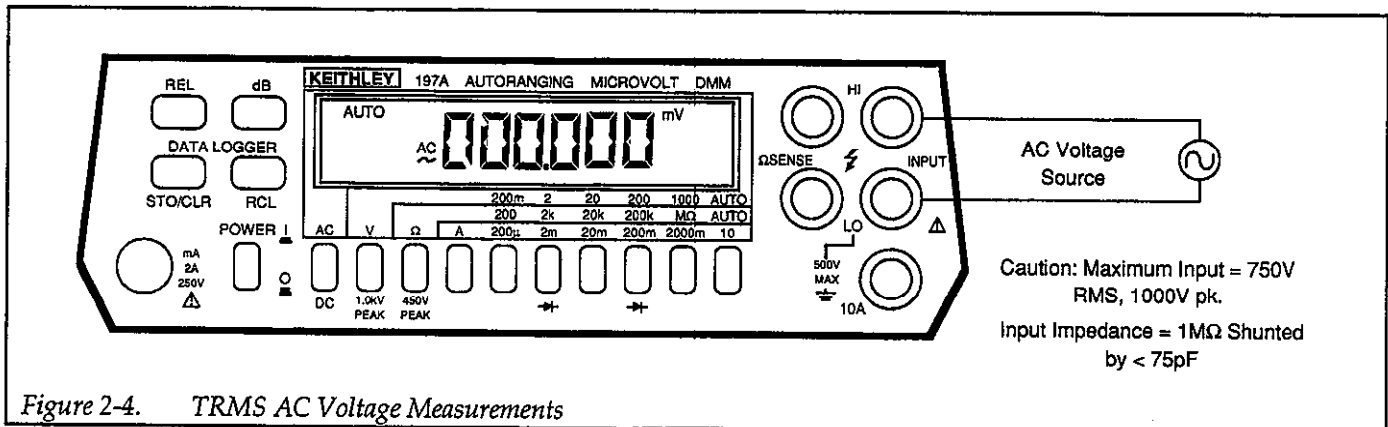

Figure 2-4. TRMS AC Voltage Measurements

by the noise present. The displayed noise of the Model 197A is $1.5\mu\text{V}$ peak to peak. This noise is inherent in the Model 197A and is the minimum amount present in all measurements. The $1.5\mu\text{V}$ of noise is due to the instrument voltage noise. The noise at the Model 197A input increases beyond this minimum when the noise current passes through a resistor thus generating a voltage noise. The total noise becomes a function of the source resistance and is given by the equation:

$$n^2 = e_n^2 + (i_n R_s)^2 + e_r^2$$

where

- n = total noise input.
- e_n = input voltage noise of the Model 197A.
- i_n = input current noise.
- R_s = parallel combination of source resistance and input impedance.
- e_r = Johnson noise of the source resistance.

Even on the most sensitive range, the noise due to the current is not applicable until R_s reaches approximately $1\text{M}\Omega$. Thus, for an R_2 of 0Ω to $1\text{M}\Omega$, the noise at the input is the inherent $1.5\mu\text{V}$ peak to peak. Beyond $1\text{M}\Omega$ the noise due to R_s becomes a limiting factor in the measurement. Therefore, it is recommended that for sensitive measurements R_s be kept relatively low, if possible below $1\text{M}\Omega$.

As an example of determining e_r noise voltage generation (due to Johnson noise of source resistance) assume that the Model 197A is connected to a voltage source with an internal resistance of $1\text{M}\Omega$. At a room temperature of 20°C (293K), the p-p noise voltage generated over a bandwidth of 1Hz will be:

$$e_r = 6.35 \times 10^{-10} \sqrt{R \times f}$$

$$e_r = 6.35 \times 10^{-10} \sqrt{(1 \times 10^6)(1)}$$

$$e_r = 0.635\mu\text{V}$$

Thus it is clear that optimum microvolt measurements with the Model 197A are possible with source resistance as high as $1\text{M}\Omega$. However, this resolution will not be realized unless shielding is employed.

Shielding — The Model 197A is insensitive to AC voltages superimposed upon a DC signal at the input terminals. However, AC voltages which are extremely large compared with the DC signal may erroneously produce a DC output. Therefore, if there is AC interference, the cir-

cuit should be shielded and the shield connected to the Model 197A ground (particularly for low-level sources). Improper shielding can cause the Model 197A to behave in one or more of the following ways:

1. Unexpected offset voltages.
2. Inconsistent readings between ranges.
3. Sudden shifts in reading.

To minimize pick up, keep the voltage source and the Model 197A away from strong AC magnetic sources. The voltage induced due to magnetic flux is proportional to the area of the loop formed by the input leads. Therefore, minimize the loop area of the input leads and connect each signal at only one point.

Thermal EMFs — Thermal emfs (thermoelectric potentials) are generated by thermal differences between two junctions of dissimilar metals. These can be large compared to the signal which the Model 197A can measure. Thermal emfs can cause the following problems:

1. Instability or zero offset is much higher than expected.
2. The reading is sensitive to (and responds to) temperature changes. This can be demonstrated by touching the circuit, by placing a heat source near the circuit or by a regular pattern of instability (corresponding to heating and air-conditioning systems or changes in sunlight).
3. To minimize the drift caused by thermal emfs, use copper leads to connect the circuit to the Model 197A. A banana plug is generally sufficient and generates just a few microvolts. A clean copper conductor such as #10 bus wire is about the best for the application. The leads to the input may be shielded or unshielded, as necessary. Refer to Shielding.
4. Widely varying temperatures within the circuit can also create thermal emfs. Therefore, maintain constant temperatures to minimize these thermal emfs. A cardboard box around the circuit under test also helps by minimizing air currents.
5. The REL control can be used to null out constant offset voltages.

2.7.6 Resistance Measurements

The Model 197A can make resistance measurements between $1\text{m}\Omega$ and $220\text{M}\Omega$. The $2\text{M}\Omega$, $20\text{M}\Omega$ and $200\text{M}\Omega$ ranges autorange when the $\text{M}\Omega$ button is selected. The Model 197A provides automatic selection of 2-terminal or 4-terminal resistance measurements. This means that

if the ohms sense leads are not connected, the measurement is done 2-terminal. If the sense leads are connected the measurement is done 4-terminal. For 4-terminal measurements, rated accuracy can be obtained as long as the maximum lead resistance does not exceed the values listed in Table 2-3. For 2-terminal or 4-terminal measurements on the 200Ω range, zero must be set by the REL function to obtain rated accuracy. For best results, on the 200Ω, 2kΩ and 20kΩ ranges, it is recommended that 4-terminal measurements be made to eliminate errors caused by the voltage drop across the test leads that occurs when 2-terminal measurements are made. To make resistance measurements, proceed as follows:

1. Connect the test leads to the HI and LO INPUT terminals. If four-wire measurements are to be made, connect an additional set of leads to the OHMS SENSE terminals.

NOTE

The Model 1641 Kelvin test lead kit is ideal for low resistance 4-terminal measurements.

2. Select the ohms function.
3. Select a range consistent with the expected resistance. If desired, use the autorange mode for automatic range selection.
4. If readings are to be made on the 200Ω range, zero the instrument to obtain rated accuracy. To zero the instrument for resistance measurements: Short the test leads together after disconnecting them from the measured circuit. If 4-wire measurements are to be made, short all four test leads as shown in Figure 2-5, allow the reading to settle then press the REL button.

5. For 2-wire measurements connect the instrument as shown in Figure 2-6. For 4-wire measurements, use the connections shown in Figure 2-7.

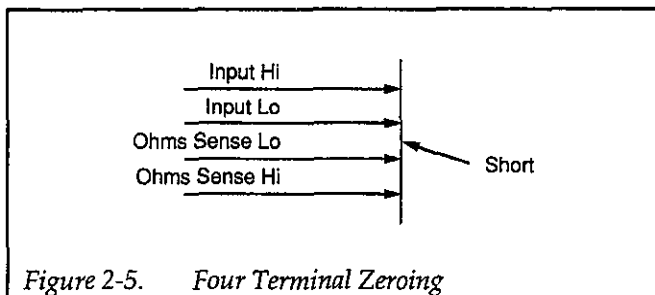

Figure 2-5. Four Terminal Zeroing

CAUTION

The maximum input voltage between the HI and LO INPUT terminals is 450V DC or peak AC for 10 seconds per minute, 350V RMS continuous. Do not exceed these values or instrument damage may occur. Table 2-3 shows the current output for various resistance ranges.

CAUTION

Incorrect readings will result if the resistance being measured is part of a live circuit.

6. Take the reading from the display.

NOTE

It is helpful to shield resistance greater than 10⁶Ω (1MΩ) if a stable reading is expected. Place the resistance in a shielded enclosure and electrically connect the shield to the LO input terminal of the Model 197A.

Table 2-3. Resistance Ranges

Range	Resolution	I-Short	Max V Across Unknown	Maximum Test Lead Resistance for <1 Count Error (Ω)
200	1mΩ	2mA	0.5V	10
2 k	10mΩ	2mA	4.0V	32
20 k	100mΩ	400μA	4.0V	100
200 k	1 Ω	40 μA	4.0V	320
2M	10 Ω	4 μA	4.0V	1K
20M	100 Ω	400 nA	4.0V	3.2K
200M	10 kΩ	400 nA	5.0V	10K

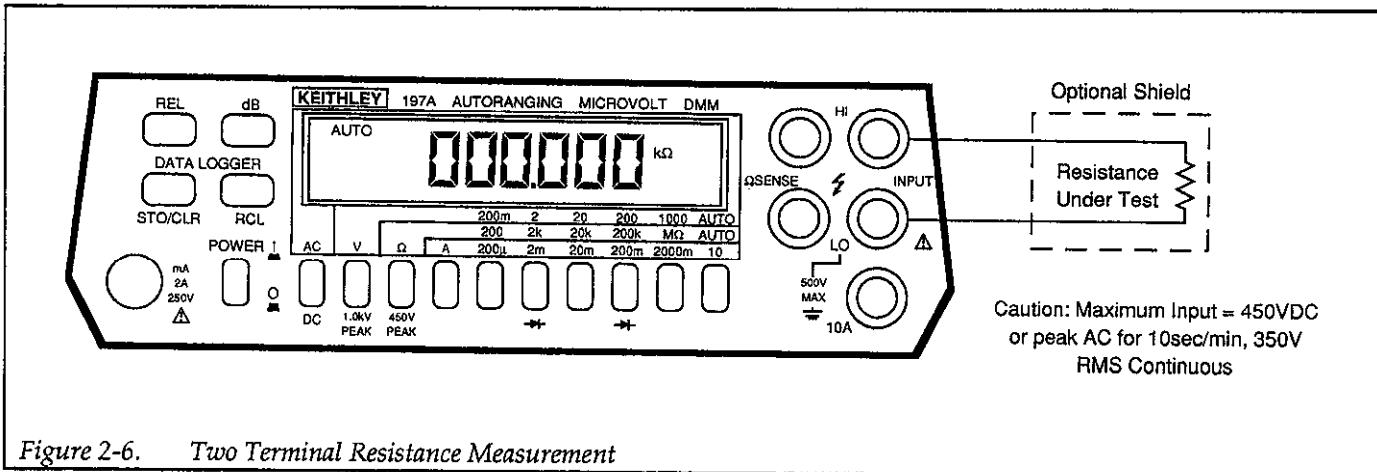

Figure 2-6. Two Terminal Resistance Measurement

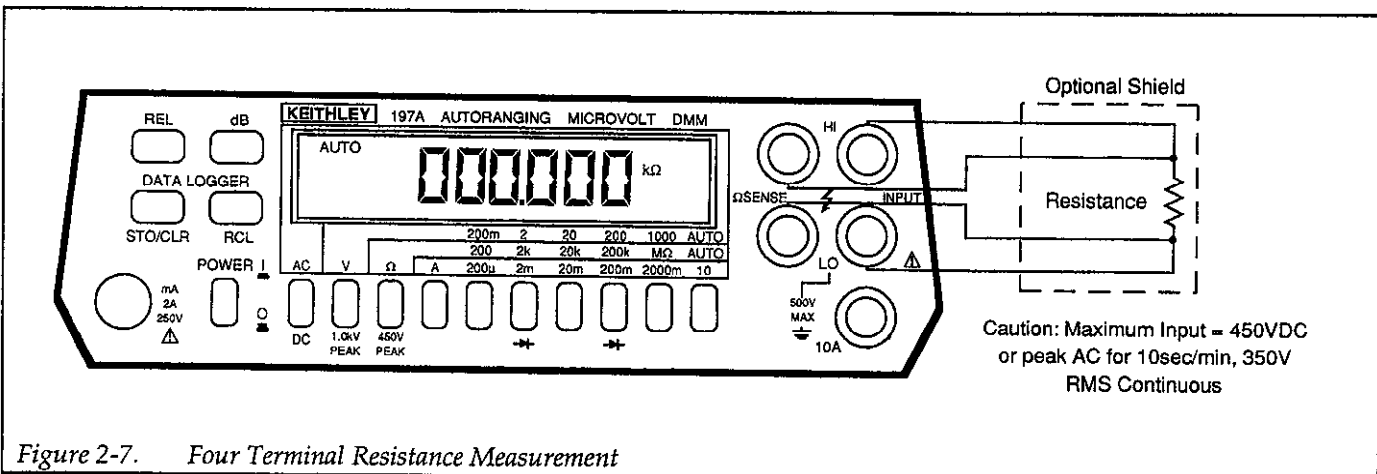

Figure 2-7. Four Terminal Resistance Measurement

2.7.7 Current Measurements (DC or TRMS AC)

The Model 197A can make DC or TRMS AC current measurements between 1nA and 10A (20A for 15 seconds). If the expected current level is in question, make the initial measurement on the 10A range. This helps prevent inadvertent blowing of the 2A current fuse which is located on the front panel.

NOTE

For routine measurements above 10A it is recommended that the Model 1651 50A shunt be used.

1. For current measurements between 2000mA and 20mA.
 - A. Connect the test leads to the 10A and LO terminals of the Model 197A. Refer to Figure 2-8.

NOTE

The test leads used must be rated to handle 20A. Twist the wires as shown in Figure 2-8 to help in minimizing external fields which could affect the Model 197A or other equipment. Also, keep the test leads as short as possible to minimize voltage drop.

- B. Select the ACA or DCA function.
- C. Select the 10A range. The amps functions does not autorange.
- D. Connect the test leads to the current source as shown in Figure 2-8 and take the reading from the display.

NOTE

Up to 5A may be applied continuously without degradation of the measurement due to self heating effects. Above 5A derate 0.15% rdg per amp for self heating, refer to specifica-

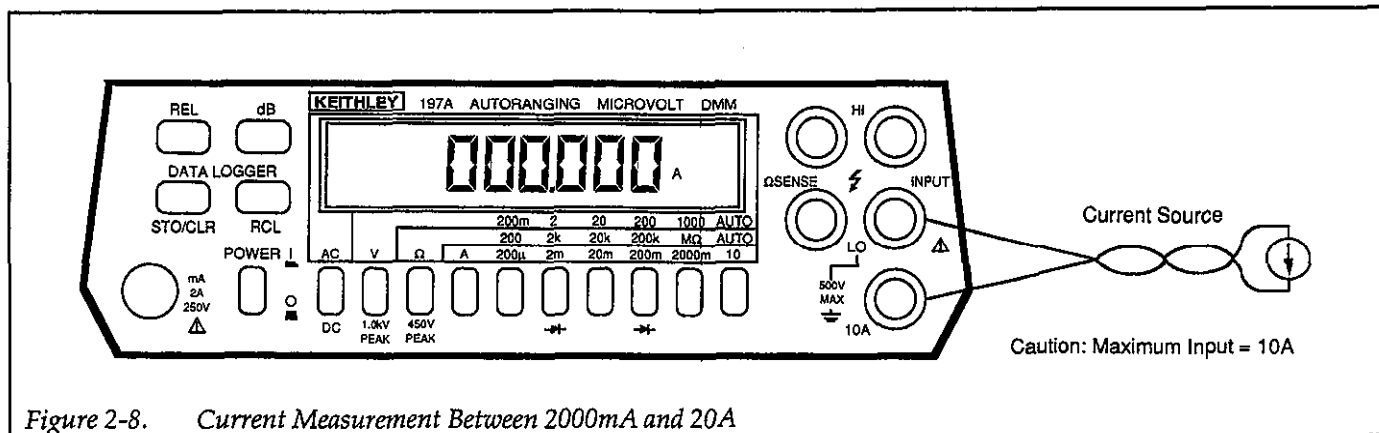

tions that precede Section 1. For currents between 10A and 20A, specified accuracy can only be obtained when measurements are limited to a maximum of 15 seconds.

2. For current measurements up to 2000mA:
 - A. Connect the test leads to the INPUT HI and LO terminals of the Model 197A.
 - B. Select the ACA or DCA function.
 - C. Select an appropriate range for the expected current. The current function does not autorange.
 - D. Connect the test leads to the current source as shown in Figure 2-9. If an overrange indication is displayed, select a higher range until a normal reading is shown. Use the lowest possible range to obtain the best resolution.

E. Take the reading from the display.

2.7.8 AC Plus DC Measurements

Use the Model 197A to measure TRMS on a signal which has both AC and DC components.

1. Measure and record the TRMS AC component as described in paragraph 2.7.4.
2. Measure and record the DC component as described in paragraph 2.7.3.
3. Compute the rms value from the following equation:

$$E_{rms} = \sqrt{E_{DC}^2 + E_{AC}^2}$$

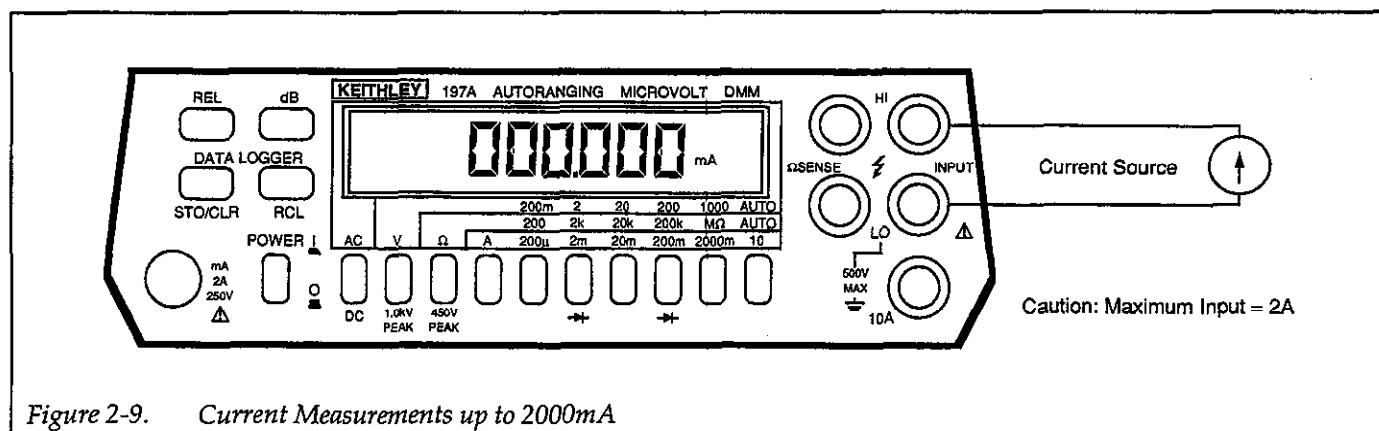

2.7.9 dB Measurements

The dB function makes it possible to compress a large range of readings into a much smaller scope. The relationship between dB and voltage can be expressed by the following equation.

$$\text{dB} = 20 \log \frac{V_{\text{IN}}}{V_{\text{REF}}}$$

Tables 2-4 and 2-5 list the dB specifications for DC volts and AC volts.

Table 2-4. dB Specifications for DC Volts (600Ω Ref)

Linear Counts	Resolution	Accuracy
10-99	1dBm	±2dBm typical
100-999	0.1dBm	±1dBm
1000-9999	0.01dBm	±0.1dBm
10000-220,000	0.01dBm	±0.02dBm

The Model 197A can make dB measurements referenced to one of six selectable impedances. The selectable reference impedances are listed in Table 2-6. dB measurements referenced to other (non-selectable) impedances can also be done. One method is to use the relative (REL)

feature. REL can also be used to make dB measurements independent of impedance.

Table 2-6. Selectable Reference Impedances

Reference Impedances
600Ω*
300Ω
135Ω
93Ω
75Ω
50Ω

*Power-up default impedance

The basic procedure for placing the instrument in the dB mode is to first select AC or DC volts and then press the dB button. The currently selected dB reference impedance will then be displayed briefly and the dB annunciator will turn on. Note that on power up, the reference impedance will default to 600Ω. To exit from the dB mode, again press dB, or press the Ω or A function button.

dBm Measurements with Selectable Reference Impedances

dBm is defined as decibels above or below a 1mW reference. The default reference impedance (on power-up) of the Model 197A is 600Ω. With this reference impedance, the Model 197A is designed to read 0dBm when the voltage needed to dissipate 1mW through a 600Ω impedance is applied. That calculated voltage level is 0.7764V as derived from the basic power equation:

Table 2-5. dB Specifications for AC Volts (600Ω Ref)

dB Mode (Ref: 600Ω)		Accuracy (±dBm)			
Range	Input	20Hz-10kHz	10kHz-20kHz	20kHz-50kHz	50kHz-100kHz
200mV	1mV to 2mV (-58 to -52dBm)	2.00	3.00	—	—
	2mV to 20mV (-52 to -32dBm)	0.85	1.10	2.00	—
	20mV to 200mV (-32 to -12dBm)	0.18	0.18	0.28	0.65
2V-750V	200mV to 750V (-12 to +59.8dBm)	0.18	0.18	0.28	0.50

$$E = \sqrt{P \cdot R}$$

$$E = \sqrt{10^{-3} \text{ W} \cdot 600 \Omega}$$

$$E = 0.77456 \text{ V}$$

Thus with a 600Ω reference impedance the Model 197A will read 0dBm whenever 0.7746V is applied.

NOTE

Do not confuse reference impedance with input impedance. The input impedance of the instrument is not modified in the dB mode.

To make dBm measurements referenced to one of the selectable impedances, proceed as follows:

1. Connect the test leads to the INPUT HI and LO terminals of the Model 197A.
2. Select the ACV or DCV function.
3. Select autorange for optimum resolution.
4. Press and hold the dB button to scroll through the selectable reference impedances (see Table 2-6) Release the button when the desired reference impedance is displayed.
5. Connect the test leads to the voltage source.
6. Make the dBm reading from the display.

dBm Measurements with Other Non-Selectable Reference Impedances

dBm measurements can be made with other reference impedances. The most convenient method for using other reference impedances is to algebraically subtract the calculated dB offset for the desired reference impedance from the reading on the display of the Model 197A Table 2-7 lists common reference impedances and the corresponding offset values. The following equation can be used to calculate the offset for impedances not listed in Table 2-7.

$$\text{Offset (for dBm)} = 10 \log \frac{\text{New ref Z}}{600 \Omega}$$

To make dBm measurements referenced to a non-selectable impedance, proceed as follows:

1. Choose the desired reference impedance.
2. Calculate or look up the offset value in Table 2-7 for the desired reference impedance.
3. Determine dBm at the desired reference impedance as follows:

$$\text{dBm (at ref Z)} = 197\text{A reading} - \text{offset}$$

Example: Make dBm measurements references to a 100Ω reference impedance.

Table 2-7. Levels for Other Reference Impedances

Reference Impedance (Ω)	Reference Voltage Level for		Offset (600Ω Ref)	
	0dBm	0dBW	0dBm	0dBW
8	0.0894	2.828	-18.75	11.25
50	0.2236		-10.79	
75	0.2739		- 9.03	
93	0.3050		- 8.10	
135	0.3674		- 6.49	
150	0.3873		- 6.03	
300	0.5477		- 3.01	
600	0.7746		0.00	
1000	1.0000		2.22	

$$V_{\text{ref. for 0dBm}} = \sqrt{10^{-3} \text{ W} \cdot Z_{\text{REF}}}$$

$$V_{\text{ref. for 0dBW}} = \sqrt{Z_{\text{REF}}}$$

$$\text{Offset (for dBm)} = 10 \log \left(\frac{Z_{\text{REF}}}{600 \Omega} \right)$$

$$\text{Offset (for dBW)} = 10 \log \left(\frac{Z_{\text{REF}}}{600 \Omega} \right) - 30 \text{ dB}$$

- A. 100Ω not listed in Table 2-7 so the offset must be calculated as follows:

$$\text{Offset} = 10 \log \left(\frac{100\Omega}{600\Omega} \right)$$

$$\text{Offset} = -7.78\text{dB}$$

- B. Subtract -7.78 from all subsequent displayed readings on the Model 197A.

dBm measurements, referenced to another impedance, can be read directly from the display of the Model 197A by utilizing the REL feature, and an accurate voltage source. The basic procedure is as follows:

1. Calculate or look up the equivalent voltage level (Table 2-7) for 0dBm at the desired reference impedance.
2. Input that voltage level to the Model 197A.
3. With the Model 197A in the dB mode, press the REL button.
4. dBm measurements referenced to the desired impedance can now be read directly from the display of the Model 197A.

dBW Measurements

dBW is defined as decibels above or below a one watt reference. The procedure is the same as that found in paragraph 2.7.9 step 2. The only difference is that the reference point is 0dBW (1W) rather than 0dBm (1mW).

dBV Measurements

dBV is defined as decibels above or below 1V (0dBV point). This is a voltage relationship independent of impedance. The basic procedure is to simply subtract 2.22dB (Table 2-7) from all subsequent displayed readings on the Model 197A.

Relative dB Measurements

Just about any voltage level within the measurement limit of the Model 197A can be established as the 0dB point. The basic procedure is to establish the level as the 0dB point by using REL and making the desired dB measurement.

2.7.10 dB Measurement Considerations and Applications

1. Typical Instrument Performance
Typically, the Model 197A will perform better than its published dB specification. The following example will illustrate this point:
 - A. Using the Model 197A in the dB mode (600Ω ref) measure a 1mV RMS, 1kHz source (common application in the communications field). Typically, the Model 197A will read -57.7dBm .
 - B. The calculated dBm level for that source is -57.8dBm .
 - C. The 0.1dBm error is considerably better than the $\pm 2\text{dBm}$ specification. The specifications are intended to cover worst measurement conditions.
2. Measuring Circuit Gain/Loss
Any point in a circuit can be established as the 0dB point. Measurements in that circuit are then referenced to that point expressed in terms of gain (+dB) or loss (-dB). To set the 0dB point:
 - A. Place the Model 197A in volts, autorange and dB.
 - B. Connect the Model 197A to the desired location in the circuit.
 - C. Press the REL button. The display will read 0dB.
 - D. Gain/Loss measurements can now be made referenced to the 0dB point.
3. Measuring Bandwidth
The Model 197A can be used to determine the bandwidth of an amplifier as follows:
 - A. Connect a signal generator to the input of the amplifier.
 - B. Set the Model 197A to ACV and autorange.
 - C. Connect the DMM and a frequency counter to the load of the amplifier.
 - D. Adjust the frequency of the signal generator until a peak AC voltage reading is measured on the Model 197A.
 - E. Press the dB button and then press the REL button. The 0dB point is now established.
 - F. Increase the frequency input until the Model 197A reads -3.00dB . The frequency measured on the frequency counter is the high end limit of the bandwidth.
 - G. Decrease the frequency input until the dB reading again falls to -3dB . The frequency measured on the signal generator is the low end limit of the bandwidth.
4. Determining Q
The Q of a tuned circuit can be determined as follows:
 - A. Determine the center frequency and bandwidth as explained in paragraph 2.7.10 step 3.
 - B. Calculate Q by using the following formula:

$$Q = \text{Center Frequency} / \text{Bandwidth}$$

2.7.11 MIN/MAX and 100 Point Data Logger Operation

The data logger can store up to 100 readings and store the minimum and maximum readings recorded during the period that the data logger is active. The 100 points of data are stored at one of seven selectable rates from three per second to one reading per hour. Also, manual triggering is available (r=6). In the r=6 mode, one reading is stored every time the STO/CLR button is pressed. Readings for minimum and maximum are sampled at the rate of three per second regardless of the selected rate. The procedure for operating the data logger is as follows:

1. Connect the desired measurement configuration to the Model 197A. Make sure that the controls of the Model 197A are set appropriately.
2. Logging Data:
 - A. Press and hold the STO/CLR button. The following reading rates will scroll on the display:

rate/meaning
r=0 (every reading)
r=1 (1 rdg/sec)
r=2 (1 rdg/10 sec)
r=3 (1 rdg/min)
r=4 (1 rdg/10 min)
r=5 (1 rdg/hour)
r=6 (1 rdg every time STO/CLR is pressed)

NOTE

There is no need to select a rate if just minimum/maximum readings are desired. Press the STO/CLR button to start the logger.

- B. Release the STO/CLR button when the desired reading rate is displayed. The STO annunciator turns on and data is logged at the selected rate.
 - C. In the manual trigger mode (r=6), a reading is stored every time the STO/CLR button is pressed. The following sequence takes place after the STO/CLR button is pressed when in the manual trigger mode.
 - a. The Model 197A stores the reading.
 - b. The buffer location number is briefly displayed. For example: Buffer location #1 is represented by n=01.

- c. The Model 197A displays the applied signal and waits for the next manual trigger.

NOTE

The logging cycle can be terminated at any time by pressing the STO/CLR button. This shuts off the data logger. However, data is retained and can be recalled at any time as long as the instrument remains on. In the r=6 mode, press the RCL and the STO/CLR button to terminate the data logger cycle.

In the store mode (STO annunciator on) and when the buffer is full (100 readings stored), the minimum and maximum readings are continuously updated. When the store mode is turned off the minimum and maximum readings are not updated.

3. Data Retrieval — Data can be retrieved at any time, but a flashing RCL annunciator indicates that the maximum number of readings (100) have been stored.
 - A. Press and hold in the RCL button. The display scrolls through the data points and MIN/MAX (LO/HI). The first data point displayed is the last stored reading. The next two data points are the HI and LO readings made during that logging cycle. Notice that the longer the RCL button is held in the faster the data points scroll on the display.
 - B. Release the RCL button at the desired data point and note the reading (data) on the display. The data pointer can be incremented by steps of one by momentarily holding in the RCL button.

2.7.12 Diode Test

The 2k Ω and 200k Ω ranges can be used for testing semiconductor junctions as follows:

1. Select the ohms function.
2. Press the 2k and 200k button (diode symbols) in simultaneously.
3. Display reads forward V drop of a silicon diode at 1.6mA (1.1mA for an LED), up to 2.2V. Red terminal is positive. Accuracy is typically better than 1.5% of reading.

2.8 TRMS CONSIDERATIONS

Most DMMs actually measure the average value of an input waveform but are calibrated to read its RMS equivalent. This poses no problems as long as the waveform being measured is a pure, low distortion sine wave. For complex, nonsinusoidal waveforms, however, measurements made with an averaging type meter can be grossly inaccurate. Because of its TRMS (True Root Mean Square) measuring capabilities, the Model 197A provides accurate AC measurement for a wide variety of AC input waveforms.

2.8.1 AC Voltage Offset

Typically, the Model 197A displays 50 counts or less of offset on AC volts with the input shorted. This offset is caused by amplifier noise and offset of the TRMS converter. This offset does not affect the reading accuracy and should not be zeroed out using the REL feature. Refer to paragraph 2.7.4 step 4.

2.8.2 TRMS Measurement Comparison

The RMS value of a pure sine wave is equal to 0.707 times its peak value. The average value of such a waveform is 0.637 times the peak value. Thus, for an average-responding meter, a correction factor must be designed in. This correction factor, K, can be found by dividing the RMS value by the average value as follows:

$$K = \frac{0.707}{0.637} = 1.11$$

By applying this correction factor to an averaged reading, a typical meter can be designed to give the RMS equivalent. This works fine as long as the waveform is a pure sine wave, but the ratios between RMS and average values of different waveforms are far from constant, and can vary considerably.

Table 2-8 shows a comparison of common types of waveforms. For reference, the first waveform is an ordi-

nary sine wave with peak amplitude of 10V. The average value of this voltage is 6.37V, while its RMS value is 7.07V. If we apply the 1.11 correction factor to the average reading, it can be seen that both meters will give the same reading, resulting in no error in the average type meter reading.

The situation changes with the half-wave rectified sine wave. As before, the peak value of the waveform is 10V, but the average value drops to 3.18V. The RMS value of this waveform is 3.86V, but the average responding meter will give 3.53V (3.18 x 1.11), creating an error of 11%.

A similar situation exists for the rectified square wave, which has an average value of 5V and an RMS value of 7.07V. Here, the average responding meter gives a reading of 5.55V (5 x 1.11), while the Model 197A gives a TRMS reading of 5V. Other waveform comparisons can be found in Table 2-8.

2.8.3 Crest Factor

The crest factor of a waveform is the ratio of its peak value to its RMS value. Thus, the crest factor specifies the dynamic range of a TRMS instrument. For sinusoidal waveforms, the crest factor is 1.414. For a symmetrical square wave, the crest factor is unity.

The crest factor of other waveforms will, of course, depend on the waveform in question because the ratio of peak to RMS value varies. For example, the crest factor of a rectangular pulse is related to its duty cycle; as the duty cycle decreases, the crest factor increases. The Model 197A has a crest factor of 3, which means the instrument gives accurate TRMS measurements of rectangular waveforms with duty cycles as low as 10%.

2.8.4 Extended Frequency Response

Figure 2-10 illustrates the extended frequency response of the ACV ranges up to 1MHz.

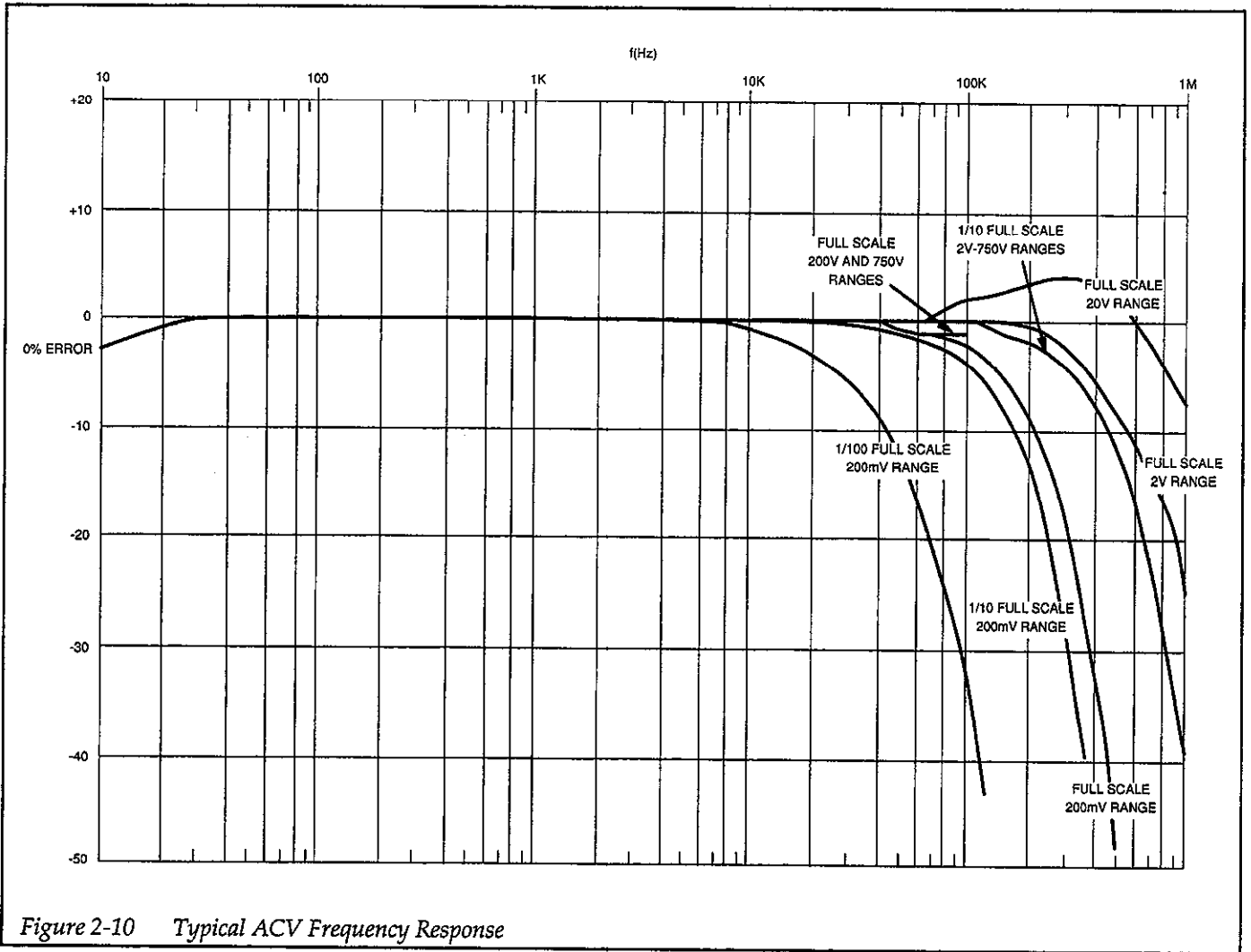
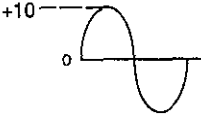

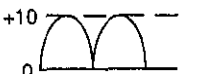

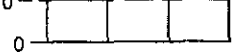
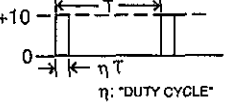
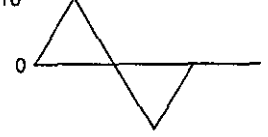

Table 2-8. Comparison of Average and TRMS Meter Readings

Waveform	AC Coupled Peak Value	RMS Value	Average Responding Meter Reading	AC Coupled TRMS Meter Reading	Averaging Meter Percent Error
Sine 	10V	7.07V	7.07V	7.07V	0%
Half-Wave Rectified Sine 	10V	5.00V	3.53V	5.00V	29.4%
Full-Wave Rectified Sine 	10V	7.07V	7.07V	7.07V	0%
Square 	10V	10.00V	11.10V	10.00V	11%
Rectified Square Wave 	10V	5.00V	5.55V	5.00V	11%
Rectangular Pulse 	10V	$10V \cdot \sqrt{\eta}$	$11.1V \cdot \eta$	$10V \cdot \sqrt{\eta}$	$(1.11V \sqrt{\eta} - 1) \cdot 100\%$
Triangular Sawtooth 	10V	5.77V	5.55V	5.77V	3.8%

SECTION 3

Performance Verification

3.1 INTRODUCTION

This section contains information necessary to verify that the Model 197A's performance is within specified accuracy. Model 197A specifications may be found at the front of this manual. Ideally, performance verification should be performed when the instrument is first received to ensure that no damage or change in calibration has occurred during shipment. The verification procedure may also be performed whenever instrument accuracy is suspect or following calibration. If performance on any of the ranges or functions is inconsistent with specifications, calibration should be performed as described in Section 4.

NOTE

If the instrument does not meet specifications and it is still under warranty (less than 12 months since date of shipment), contact your Keithley representative or the factory to determine the action to be taken.

3.2 ENVIRONMENTAL CONDITIONS

All measurements should be made at an ambient temperature between 18°C and 28°C (65°F to 82°F) with a relative humidity less than 80%.

3.3 RECOMMENDED TEST EQUIPMENT

Equipment for verifying the performance of the Model 197A is listed in Table 3-1. Alternate equipment may be used as long as equipment accuracy is at least equal to the specifications listed in Table 3-1.

NOTE

The verification limits in this section only reflect the specifications of the Model 197A. They do not include test equipment tolerance.

3.4 INITIAL CONDITIONS

Before performing the verification procedures, make sure the Model 197A meets the following conditions:

1. If the instrument has been subjected to temperature below 18°C (65°F) or above 28°C (82°F), allow sufficient time for the instrument to reach temperatures within the range. Generally, it takes one hour to stabilize an instrument that is 10°C (18°F) outside of this range.
2. Turn on the Model 197A and allow it to warm up for one hour. The instrument may be operated from either line power or battery pack power, as long as the battery pack has been fully charged as described in paragraph 2.3.3.

Table 3-1. Equipment Specifications

Mfg	Model	Description	Specifications
Fluke	343A	DC Voltage Calibrator	200mV, 2V, 20V, 200V, 1000V ranges $\pm 0.005\%$
Fluke	5200A	AC Voltage Calibrator	200mV, 2V, 20V, 100V, 50Hz to 10kHz $\pm 0.05\%$
Valhalla	2500E	AC-DC Current Calibrator	200 μ A, 2mA, 20mA, 200mA, 2000mA, 10A ranges $\pm 0.03\%$ DC, $\pm 0.1\%$ AC to 5kHz (at full scale)
Fluke	5450A	Resistance Calibrator	100 Ω , 1k Ω , 10k Ω , 100k Ω ranges $\pm 0.05\%$; 1m Ω range $\pm 0.01\%$; 10M Ω range $\pm 0.05\%$; 100M Ω $\pm 0.5\%$
Fluke	5215A	Power Amplifier	1000V range: 10Hz-30Hz $\pm 0.12\%$; 50kHz-100kHz $\pm 0.10\%$; 100V max @ 100kHz = 10^7 VHZ; 750V max @ ≈ 13 kHz = 10^7 VHZ

3.5 VERIFICATION PROCEDURE

The following paragraphs give the basic verification procedure for the following functions DC volts, AC volts, resistance and current.

CAUTION

Do not exceed 1000V between the input HI and LO terminals or damage to the instrument may occur.

WARNING

The maximum common-mode voltage (voltage between input low and chassis ground) is 500V peak. Exceeding this value may cause a shock hazard. Some of the procedures in this section may expose the user to dangerous voltages. Use standard safety precautions when such dangerous voltages are encountered.

2. Connect the calibrator to the instrument as shown in Figure 3-1.
3. Set the calibrator to 0V and enable the relative mode. Leave the relative mode enabled for all DCV measurements. Check to see that the reading is 000.000V ± 1 count.
4. Apply a positive 200mV to the HI and LO INPUT terminals. The reading must be within the limits specified in Table 3-2.
5. For each remaining range, apply the required voltage as specified in Table 3-2 and verify that the reading is within specifications.
6. repeat all checks with negative voltage.

3.5.1 DC Voltage Accuracy Check

1. Select the DC volt function and autorange.

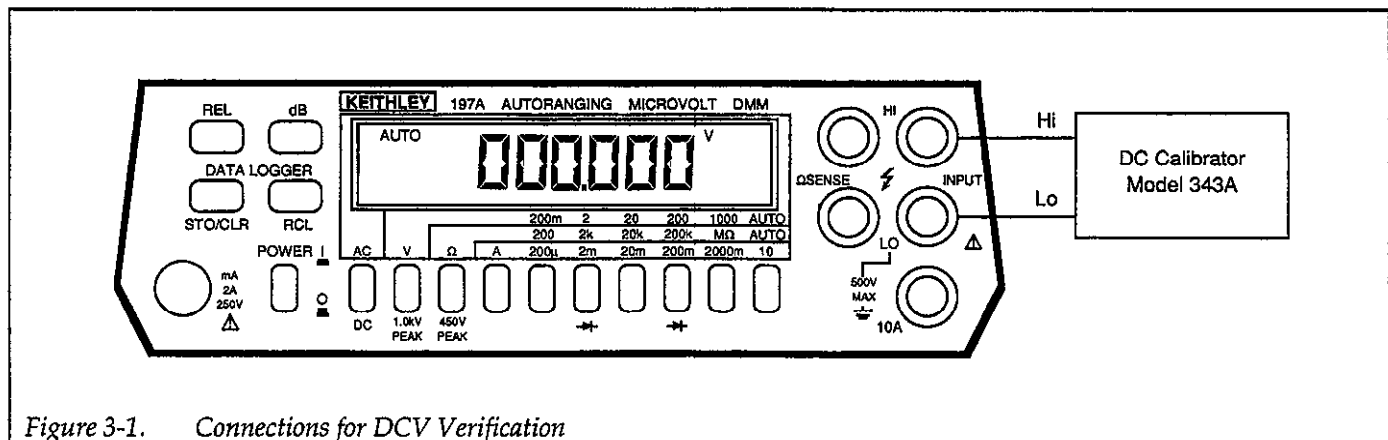

Figure 3-1. Connections for DCV Verification

Table 3-2. Limits for DC Voltage Verification

197A DCV Range	Applied DC Voltage	Allowable Readings (18°C to 28°C)
200mV	200.000mV	199.965 to 200.035
2 V	2.00000 V	1.99976 to 2.00024
20 V	20.0000 V	19.9968 to 20.0032
200 V	200.000 V	199.968 to 200.032
1000 V	1000.00 V	999.83 to 1000.17

10⁷VHz between HI and LO INPUT terminals or instrument damage may occur.

3.5.2 AC Voltage Accuracy Check

CAUTION

Do not exceed 750V RMS, 1000V peak

1. Select the AC volts function and autorange. Do not use REL to zero the offset in this procedure. Refer to paragraph 2.7.4 step 4.
2. Connect the AC calibrator to the HI and LO INPUT terminals of the Model 197A as shown in Figure 3-2.
3. Set the calibrator to output 2.00000V at a frequency of 50Hz. Verify that the reading is within the limits specified in Table 3-3.
4. Repeat the 2.00000V AC measurement at the other frequencies specified in Table 3-3.
5. Check the 20V, 200V and 750V ranges by applying the required voltage and frequencies specified in Table 3-3 and verifying that the readings are within the specified limits.

Table 3-3. Limits for AC Voltage Verification

197A AC Range	Applied AC Voltage	20Hz	50Hz	10kHz	20kHz	50kHz	100kHz
200mV	200.000mV	197.900	199.200	198.600	196.750	189.600	189.600
		to 202.100	to 200.800	to 201.400	to 203.250	to 210.400	to 210.400
2 V	2.00000V	1.97900	199.200	1.98600	1.96750	1.93600	1.93600
		to 2.02100	to 2.00800	to 2.01400	to 2.03250	to 2.06400	to 2.06400
20 V	20.0000V	19.7900	19.9200	19.8600	19.6750	19.3600	19.3600
		to 20.2100	to 20.0800	to 20.1400	to 20.3250	to 20.6400	to 20.6400
200 V	200.000V	197.900	199.200	198.600	196.750	193.600	*
		to 202.100	to 200.800	to 201.400	to 203.250	to 206.400	
750 V	750.000V	739.63	745.25	740.50	*	*	*
		to 760.37	to 754.75	to 759.50			

*Exceeds the V•Hz product.

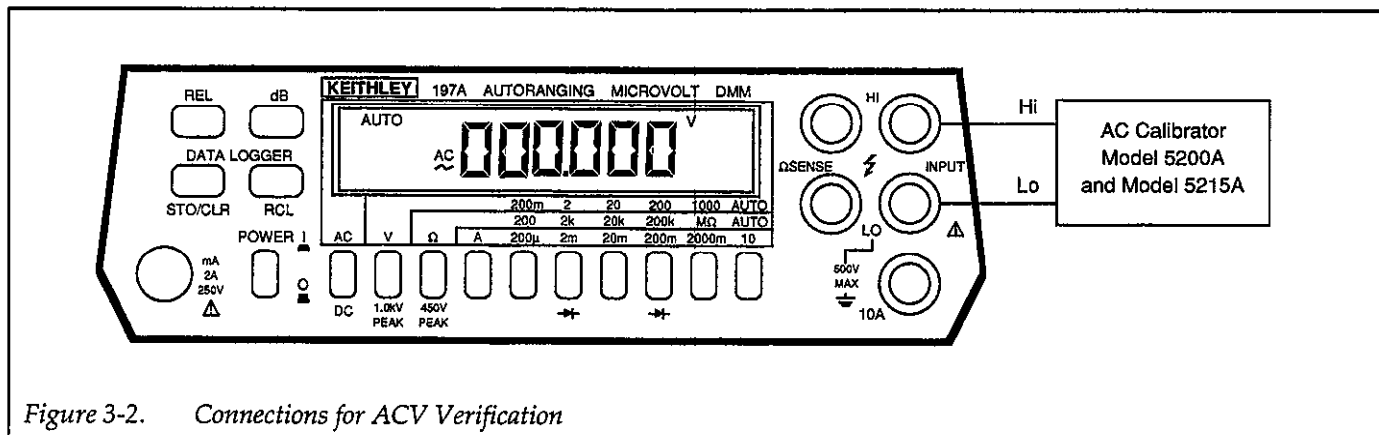

Figure 3-2. Connections for ACV Verification

3.5.3 Resistance Accuracy Check

Resistance verification is performed by connecting known, precise resistance values to the HI and LO input terminals and checking to see that the displayed reading is within the required limits. Measurements on the 200Ω, 2kΩ and 20kΩ ranges will be done using the 4-terminal configuration to minimize errors due to the voltage drop across the test leads.

CAUTION

Do not exceed 450VDC or peak AC for 10 seconds per minute, 350V rms continuous between the HI and LO INPUT terminals or the instrument might be damaged.

1. Select the ohms function (AC/DC button must be out) and the 200Ω range.
2. Use Kelvin test leads (e.g. Keithley Model 1641) in the input HI and LO, and then OHMS SENSE HI and LO terminals. Short the leads together. Enable the relative (REL) mode. Check to see that the display reads 000.000. Leave the relative mode enabled for the remaining resistance measurements.
3. Connect the 190Ω calibration resistor as shown in Figure 3-3. Note that the 4-terminal configuration is used for this measurement.
4. Check to see that the displayed reading is within the limits specified in Table 3-4.
5. Connect a 1.9kΩ calibration resistor to the instrument as shown in Figure 3-3. Switch the instrument

to the 2kΩ range. Verify that the displayed reading is within the limits specified in Table 3-4.

6. Connect a 19kΩ calibration resistor to the instrument as shown in Figure 3-4. Switch the instrument to the 20kΩ range. Verify that the displayed reading is within the limits specified in Table 3-4.
7. Connect a 190kΩ calibration resistor to the instrument as shown in Figure 3-4. Switch the instrument to the 200kΩ range. Verify that the displayed reading is within the limits specified in Table 3-4. Note that the 2-terminal configuration may be used on the 200kΩ and higher ranges.
8. Continue with each of the calibration resistance values listed in Table 3-4. Be sure to place the Model 197A on the correct range for each measurement. The remaining readings may be done using 2-terminal configuration.

Table 3-4. Limits for Resistance Verification

197A Range	Applied Resistance	Allowable Readings (18°C to 28°C)
200	190.000 Ω	189.963 to 190.037
2 k	1.90000 kΩ	1.89964 to 1.90036
20 k	19.0000 kΩ	18.9949 to 19.0051
200 k	190.000 kΩ	189.949 to 190.051
2M	1.90000MΩ	1.89931 to 1.90069
20M	19.0000MΩ	18.9770 to 19.0230
200M	190.000MΩ	186.199 to 193.801

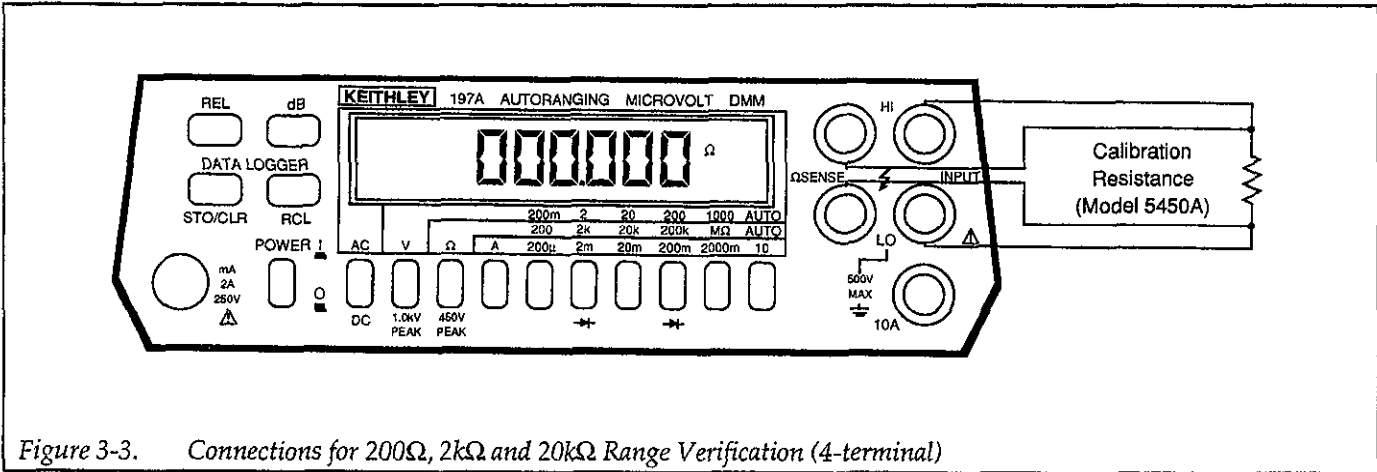

Figure 3-3. Connections for 200Ω, 2kΩ and 20kΩ Range Verification (4-terminal)

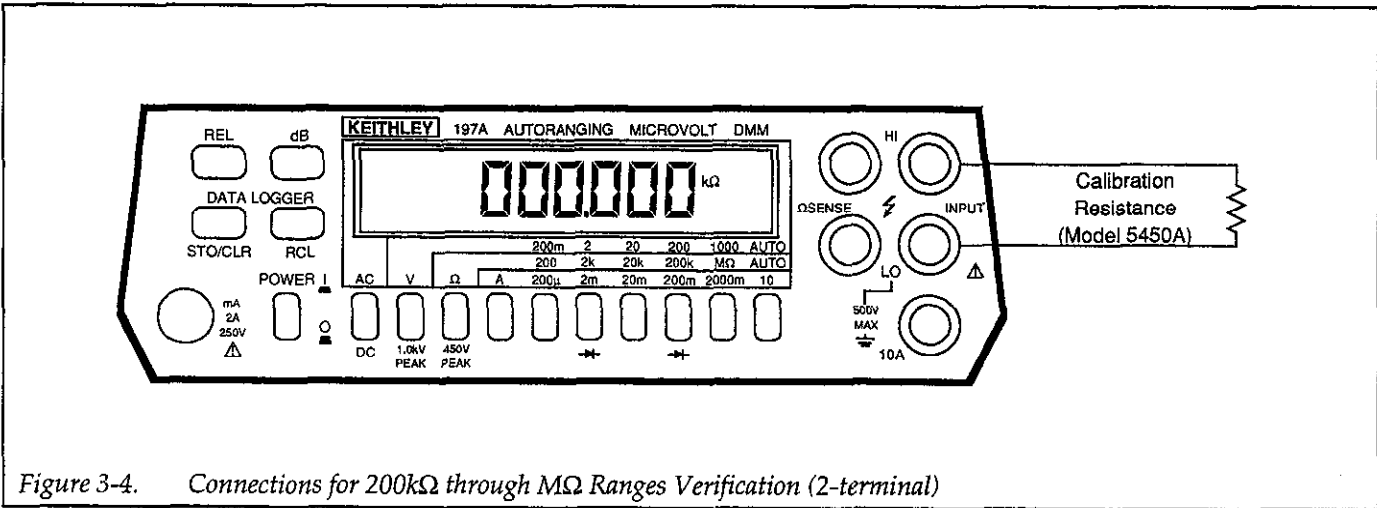

Figure 3-4. Connections for 200kΩ through MΩ Ranges Verification (2-terminal)

3.5.4 DC Current Accuracy Check

DC current accuracy is checked by connecting a calibrated DC current source to the HI and LO INPUT terminals for up to 2000mA (10A and LO terminals for 2000mA through 10A). The accuracy is then verified by referring to Table 3-5 which shows the exact number of counts allowed in order to remain in the limit of the specifications.

CAUTION

Do not exceed 2A to the HI and LO INPUT terminals or the front panel amps fuse will blow. Refer to paragraph 2.4.4.

1. Select the DC current function. Select the 2000mA range.
2. Connect the instrument to the DC current calibrator as shown in Figure 3-5. The HI side of the AMPS terminal should be connected to the HI terminal and the LO side of the calibrator output should be connected to LO.
3. Set the calibrator to 00.000 and enable the relative (REL) mode.
4. Verify that the displayed reading is within the limits specified in Table 3-5.

5. Switch the Model 197A to the 20mA range. Set the calibrator to output +20.0000mA. Verify that the displayed reading is within the limits specified in Table 3-5.
6. Switch the Model 197A to the 200mA range. Set the calibrator to output +200.000mA. Verify that the displayed reading is within the limits specified in Table 3-5.
7. Switch the Model 197A to the 2000mA range. Set the calibrator output +2000.00mA. Verify that the reading is within the limits specified in Table 3-5.
8. Set the Model 197A to the 10A range. Connect the DC current to the 10A and LO terminal as shown in Figure 3-6.

NOTE

Be sure to connect the calibrator to the 10A and LO terminals. Otherwise, applying the 5A (as specified in Table 3-5) would blow the front panel current fuse.

9. Apply +0.50000VDC to the current calibrator to output 5.0000A. Verify that the reading is within the limits specified in Table 3-5.
10. Repeat steps 1 through 10 with negative current.

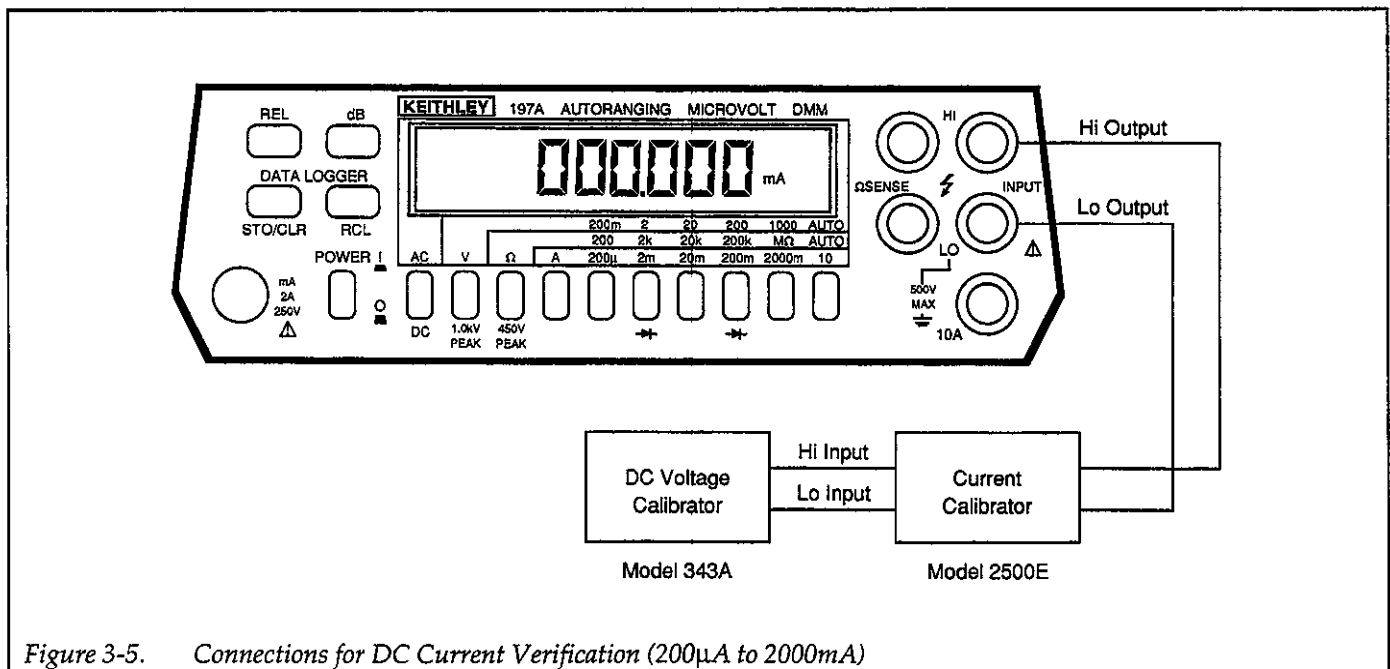

Figure 3-5. Connections for DC Current Verification (200μA to 2000mA)

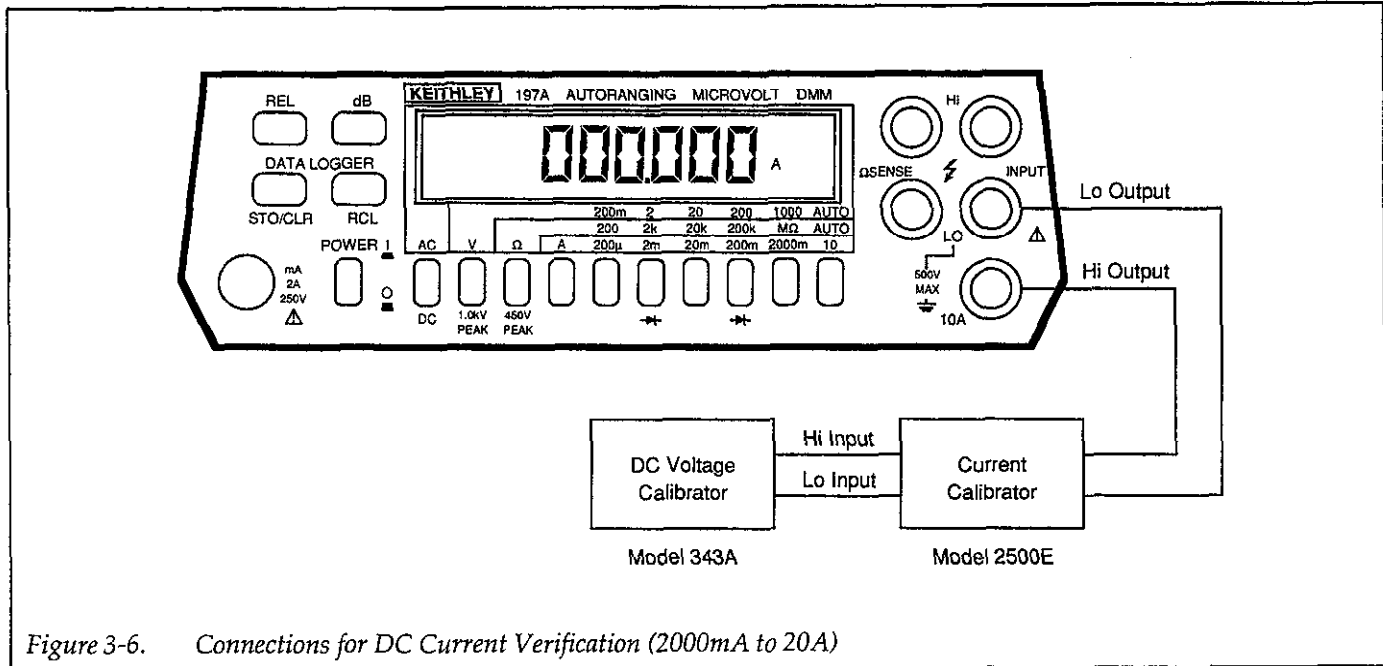

Figure 3-6. Connections for DC Current Verification (2000mA to 20A)

Table 3-5. Limits for DC Current Verification

197A DC Range	Applied DC Current	Allowable Readings (18°C to 28°C)
200μA	200.00μA	199.785 to 200.215
2mA	2.00000mA	1.99785 to 2.00215
20mA	20.0000mA	19.9785 to 20.0215
200mA	200.000mA	199.585 to 200.415
2000mA	2000.00mA	1995.85 to 2004.15
10 A	5.0000 A	4.9735 to 5.0265

3.5.5 AC Current Accuracy Check

AC current accuracy is checked by connecting a calibrated AC current source to the HI and LO INPUT terminals for 200μA to 2000mA, 10A and LO terminals for 2000mA to 20A, and then verifying that the displayed reading is within the specified range.

CAUTION

Do not exceed 2A between the HI and LO INPUT terminals or instrument damage might occur. Refer to paragraph 2.4.4.

1. Select the AC current function on the Model 197A. Place the instrument in the 2000mA range.
2. Connect the AC calibrator to the Model 197A as shown in Figure 3-7. Set the calibrator frequency to 1kHz. Do not use the relative mode to zero the offset in the AC mode.
3. Set the calibrator to output 200.000μA and switch the Model 197A to the 200μA range. Verify that the displayed reading is within the limits specified in Table 3-6.
4. Change the Model 197A to the 2mA range. Set the calibrator to output 2.00000mA. Verify that the displayed reading is within the limits specified in Table 3-6.
5. Change the Model 197A to the 20mA range. Set the calibrator to output 20.0000mA. Verify that the displayed reading is within the limits specified in Table 3-6.
6. Change the Model 197A to the 200mA range. Set the calibrator to output 200.000mA. Verify that the displayed reading is within the limits specified in Table 3-6.
7. Change the Model 197A to the 2000mA range. Set the calibrator to output 2000.00mA. Verify that the displayed reading is within the limits specified in Table 3-6.
8. Connect the calibrator to the Model 197A 10A and LO terminals as shown in Figure 3-8. Change the Model 197A to the 10A range.

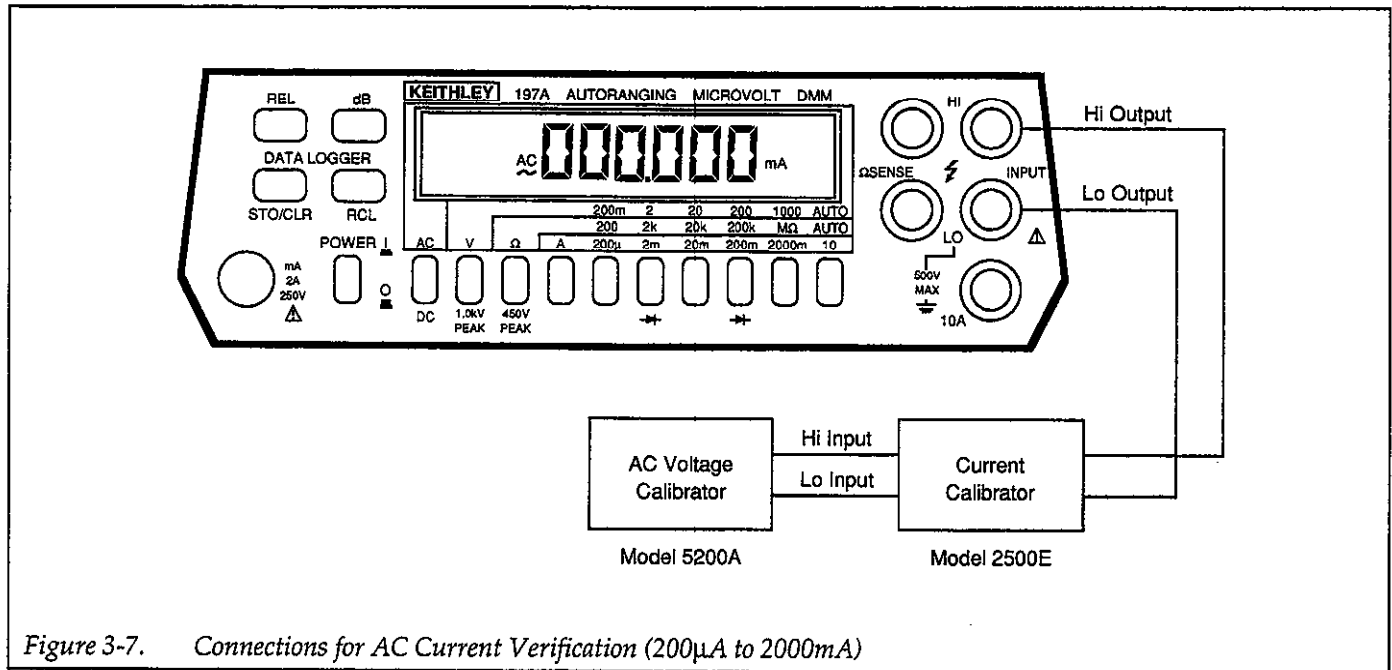

Figure 3-7. Connections for AC Current Verification (200µA to 2000mA)

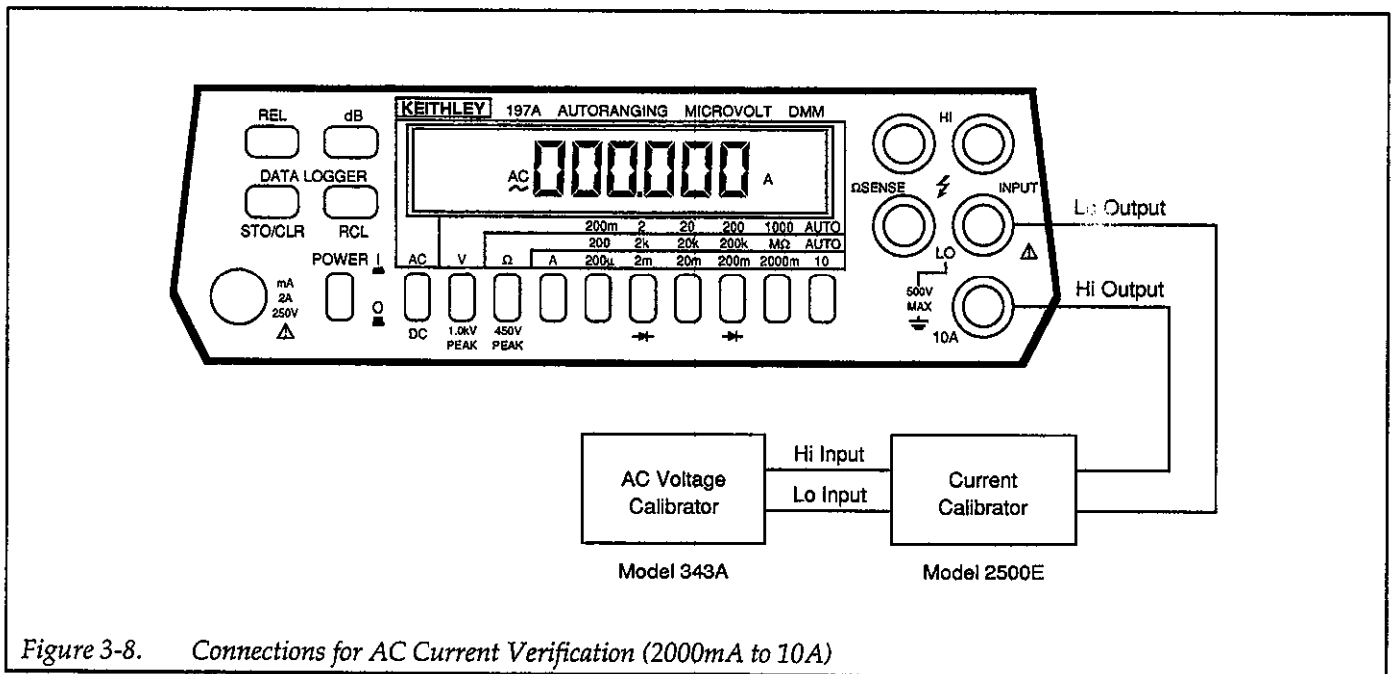

Figure 3-8. Connections for AC Current Verification (2000mA to 10A)

NOTE

Be sure to connect the calibrator to the 10A and LO terminals. Otherwise, applying the 5A (as specified in Table 3-6) would blow the front panel current fuse.

9. Set the calibrator to output 5.0000A. Verify that the displayed reading is within the limits specified in Table 3-6.

Table 3-6. Limits for AC Current Verification

197A AC Range	Applied AC Current	20Hz	50Hz	10kHz	30kHz
200μA	200.000μA	197.900 to 202.100	198.300 to 201.700	198.300 to 201.700	195.750 to 204.250
2mA	2.00000mA	1.97900 to 2.02100	1.98300 to 2.01700	1.98300 to 2.01700	1.95750 to 2.04250
20mA	20.0000mA	19.7900 to 20.2100	19.8300 to 20.1700	19.8300 to 20.1700	19.5750 to 20.4250
200mA	200.000mA	197.900 to 202.100	198.300 to 201.700	198.300 to 201.700	—
2000mA	2000mA	1979.00 to 2021.00	1983.00 to 2017.00	1983.00 to 2017.00	—
10A	5.0000 A	4.9150 to 5.0850	4.9400 to 5.0600	4.9400* to 5.0600	—

*Not to exceed 1kHz



SECTION 4

Maintenance

4.1 INTRODUCTION

This section contains installation, service and calibration information for the Model 197A and Model 1978. Fuse replacement, line voltage selection and troubleshooting procedures are also included in this section.

WARNING

The procedures described in this section are intended for use by qualified service personnel only. Do not perform these procedures unless qualified to do so. Many of the steps covered in this section expose the individual to potentially lethal voltages that could result in personal injury or death if normal safety precautions are not observed.

4.2 DISASSEMBLY INSTRUCTIONS

If it is necessary to troubleshoot the instrument, replace a component, or install an option, use the following disassembly procedure. Disassembly should be done in order that it is presented since, in general, each step depends on a previously performed procedure. Most parts referred to in the following steps are shown in Figure 4-1.

WARNING

Disconnect the line cord and any test leads from the instrument.

Top Cover Removal

1. Turn off the power, disconnect the line cord and remove all test leads from the terminals of the Model 197A.
2. Turn the unit over and remove the four screws from the bottom of the case.
3. Turn the unit over again and separate the top cover from the rest of the unit.

NOTE

When reinstalling the top cover, make sure to properly position the tilt-bail / handle into the bottom cover.

IEEE-488 Interface Removal (If Installed)

The interface board is secured to the mother board by the 6-pin male connector (P1008) and a rear standoff. To remove the interface board, gently lift it upward until it separates from the connector and the standoff.

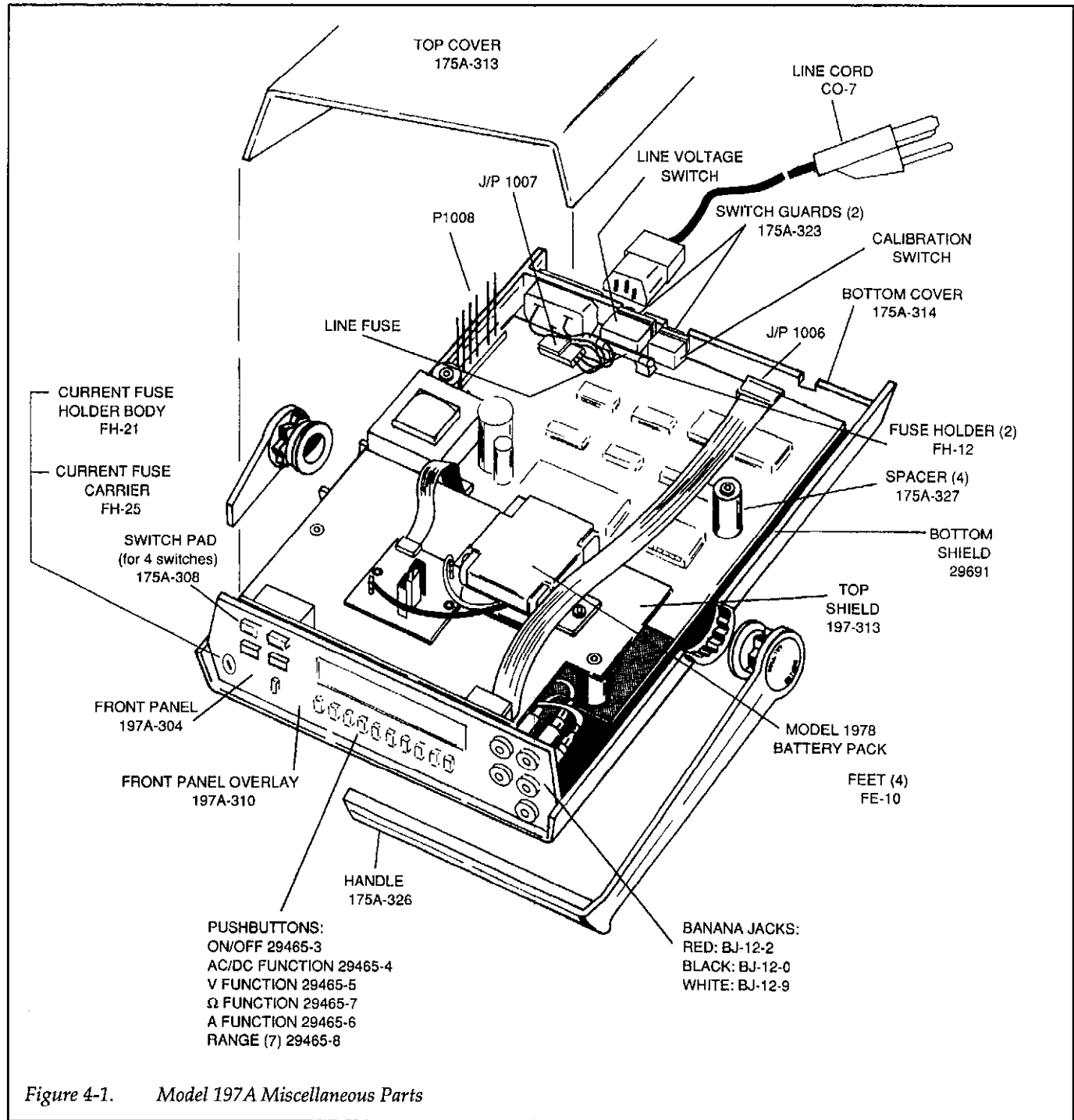

Figure 4-1. Model 197A Miscellaneous Parts

Battery Pack Removal (If Installed)

The Model 1978 battery pack is mounted on top of the mother board top shield. Perform the following steps to remove the complete shield/battery pack assembly:

1. Disconnect the battery pack ribbon cable connector from P1009 on the mother board.
2. Remove the one screw that secures the top shield to the mother board. The screw is located at the rear of the shield.
3. Carefully remove the shield/battery pack assembly from the unit.

Display Board Removal

1. Disconnect the display board ribbon cable from the mother board at J/P1006.
2. Disconnect the input leads from the input jack terminals. Table 4-1 provides terminal identification for reassembly.
3. Remove the front panel assembly from the unit.
4. The display board assembly is secured to the front panel with three screws. Remove these three screws and separate the display board assembly from the front panel.
5. The LCD (liquid crystal display) assembly is secured to the display board by five tabs. To remove, gently push the tabs away from the display board and pull the LCD assembly away from the display board. The phosphor layer of the electroluminescent backlight will remain intact with the display board. An exploded view of the display assembly is shown in Figure 4-2.

Table 4-1. Input Terminal Identification

Input Terminal	Conductor Insulator Color
INPUT HI	Red
INPUT LO	Black
Ω SENSE HI	Orange
Ω SENSE LO	Grey
10A INPUT	White

Mother Board Removal

1. Disconnect the AC power receptacle from the mother board at J/P1007.
2. Remove the four case spacers.

3. Carefully lift the mother board out of the bottom case cover.

WARNING

When reinstalling the mother board, make sure the two switch guards are installed on the rear panel CALIBRATION and LINE VOLTAGE slide switches. These switch guards block openings in the rear panel preventing access to hazardous voltage.

4.3 BATTERY PACK (Model 1978) INSTALLATION

Refer to Figure 4-1 and perform the following procedure to install the battery pack:

WARNING

Disconnect the line cord and remove all test leads from the terminals of the Model 197A.

1. Remove the top cover as explained in paragraph 4.2.
2. Remove the shield.
 - A. Remove the screw that secures the shield to the mother board. The screw is located at the rear of the shield.
 - B. Carefully pull up on either side of the shield.
 - C. Lift the shield out of the Model 197A.
3. Position the battery board as shown in Figure 4-1 and secure it to the shield using the two supplied screws. The screws are positioned through the shield into the battery board fasteners.
4. Place the battery pack in the bracket and position on the shield as shown. Route the two screws through the shield into the bracket and tighten.

CAUTION

Do not allow the battery leads to short together or damage to the batteries may occur.

5. Connect the red battery lead to the +RED terminal pin on the battery board. Connect the black battery lead to the -BLK terminal pin on the battery board.

CAUTION

Be careful not to reverse the wires (NOTE: Reds to Red and Black to Black).

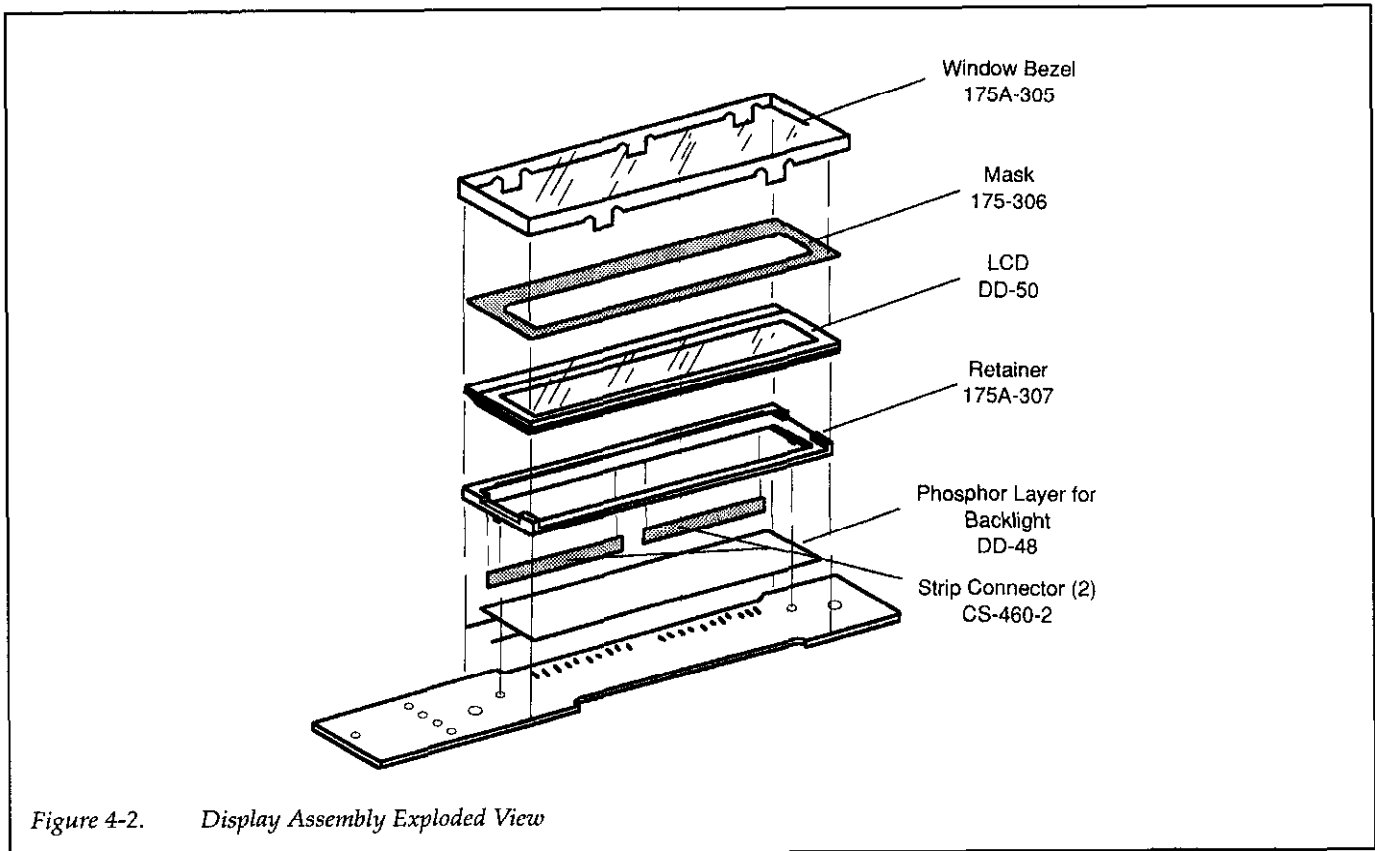

Figure 4-2. Display Assembly Exploded View

6. Carefully place the shield (with battery pack) back into the Model 197A so that it seals properly on the two spacers. Replace retaining screw in the shield.

NOTE

The retaining screw on the rear of the shield also serves to connect the shield to circuit LO.

7. Connect the ribbon cable from the battery board to P1009 on the mother board. Make sure pin 1 on the cable connects to pin 1 of P1009. Refer to the detailed drawing of Figure 4-1.

CAUTION

Make a close visual inspection of the connections to ensure that they are properly connected. Otherwise, damage to the instrument may result.

8. Reinstall the top cover as explained in paragraph 4.2.

NOTE

The IEEE Interface options do not run off of battery power.

4.4 LINE VOLTAGE SELECTION

The Model 197A may be operated from either 105V-125V or 210V-250V, 50-60Hz. A special transformer may be installed for 90-110V or 195-235V operation. The instrument was shipped from the factory set for an operating voltage marked on the front panel. To change the line voltage, proceed as follows:

1. Turn off the Model 197A and disconnect it from line power.
2. Set the LINE VOLTAGE switch on the back of the instrument to correspond to line voltage available. Example: 110VAC is available, set the switch to 105V-125V.

CAUTION

Connect only to the line voltage selected. Application of incorrect voltage can damage the instrument.

3. Plug the power cord into a properly grounded outlet.

WARNING

Ground the instrument through a properly grounded receptacle before operation. Failure to ground the instrument can result in severe injury or death in the event of a short circuit or malfunction.

4.5 FUSE REPLACEMENT

WARNING

Disconnect the instrument from the power line and from other equipment before replacing fuses.

4.5.1 Line Fuse Replacement

The line fuse is located internally in the Model 197A. For exact fuse location refer to Figure 4-1. To replace the fuse proceed as follows:

1. Remove the top cover as explained in paragraph 4.2.
2. If the Model 1973A or Model 1972A IEEE-488 interface is installed, it must be removed to gain access to the fuse. The IEEE board secured to the mother board by a support post at the rear and connector P1008. To remove, lift the board up until it disengages from the connector and support post.
3. Replace the blown fuse with the following type: 1/8A, 250V, 3AG, Slo-Blo (Keithley Part Number FU-20).

CAUTION

Do not use a fuse with a higher rating than specified or instrument damage may occur. If the instrument persistently blows the fuse, a problem may exist within the instrument. If so, the problem must be corrected before operation may continue.

4. If the IEEE interface was installed, reinstall the interface as follows:
 - A. Install the rear standoffs.
 - B. Position the interface board above the rear standoffs.

WARNING

Do not push down on J1008. The male connector pins will pass through J1008 and may cause personal injury.

- C. Guide the terminals of P1008 and firmly push down on that end of the board to mate the connectors.
 - D. Push down on the other side of the interface board until it snaps onto the rear most standoff. Make sure the board is properly seated on the other two standoffs.
 - E. Reinstall the modified top cover.
5. Reinstall the top cover as explained in paragraph 4.2

4.5.2 Current Fuse Replacement

The current fuse protects the 200 μ A through 2000mA ranges from an input current greater than 2A. To replace the current fuse, perform the following steps:

1. Turn off the power, disconnect the power line and remove the test leads.
2. Place the end of a flat blade screwdriver into the slot of the fuse holder on the front panel. Carefully press in and rotate the fuse carrier one-quarter turn counter-clockwise. Release pressure, remove the fuse and the fuse carrier from the front panel.
3. Remove the defective fuse and replace it with the following type:

2A, 250V, 3AG, normal blow (Keithley Part Number FU-13) or equivalent.

CAUTION

Use only the recommended fuse type. If a fuse with a higher current rating is installed, instrument damage may occur upon overload.

4.6 FRONT PANEL CALIBRATION

Calibration should be performed every 12 months, or if the performance verification procedures in Section 3 show that the Model 197A is out of specification. If any of the calibration procedures in this section cannot be performed properly, refer to the troubleshooting information in this section. If the problem persists, contact your Keithley representative or the factory for further information.

NOTE

ACA and DCA do not need to be calibrated. These current ranges are calibrated when ACV is calibrated.

4.6.1 Recommended Calibration Equipment

Calibration may be performed using the equipment listed in Table 4-2. Alternate calibration equipment may be used as long as the equipment's accuracy is at least as good as the specifications listed in Table 4-2.

4.6.2 Environmental Conditions

Calibration should be performed in an ambient temperature of 23°C ±3°C and a relative humidity of less than 70%. If the instrument has been subject to temperature outside of this range, or to higher humidity, allow at least one additional hour for the instrument to stabilize before beginning the calibration procedure.

4.6.3 Calibration Switch

The Model 197A is shipped from the factory with its external calibration switch in the DISABLED position. In this position, calibration constants cannot be stored when entered from the front panel or over the IEEE-488 bus. The switch must be moved to ENABLED to allow calibration constant storage.

The calibration switch is located in the middle of the rear panel. Slide the switch to ENABLED. Plug in the line cord

and turn on the instrument. Press in the REL and dB push-buttons simultaneously until the message "CAL" is displayed. Release the buttons. The unit is now in calibration as indicated by the "C" annunciator.

WARNING

Some procedures require the use of high voltage. Take care to prevent contact with live circuits which could cause electrical shock resulting in injury or death.

NOTE

Calibration may be stopped at any time and if desired, only selected ranges may be calibrated.

4.6.4 DC Voltage Calibration

Select the DCV function. Connect the DC calibrator to the Model 197A as shown in Figure 4-3.

NOTE

The following procedure must be performed in the exact sequence listed.

1. Press the REL and dB buttons simultaneously until the message "CAL" is displayed. Release the buttons. The Model 197A is now in the calibration mode.

Table 4-2. Recommended Calibration Equipment

Description	Required Minimum Specifications	Mfr.	Model No.
DV Voltage Calibrator	200mV, 0.003% + 0.5μV 2V, 0.003% + 0.5μV 20V, 0.003% + 0.5μV 200V, 0.003% + 0.5μV 1000V, 0.003% + 0.5μV (90 day accuracy)	Fluke	5440
AC Voltage Calibrator	200mV, 2V, 20V, 200V and 750V ranges, ±0.05%	Fluke	5200A & 5215A
Resistance Calibrator	190Ω, 50ppm 1.9kΩ, 50ppm 19kΩ, 50ppm 190kΩ, 50ppm 1.9MΩ, 100ppm 19MΩ, 500ppm (90 day accuracy)	Fluke	5450A

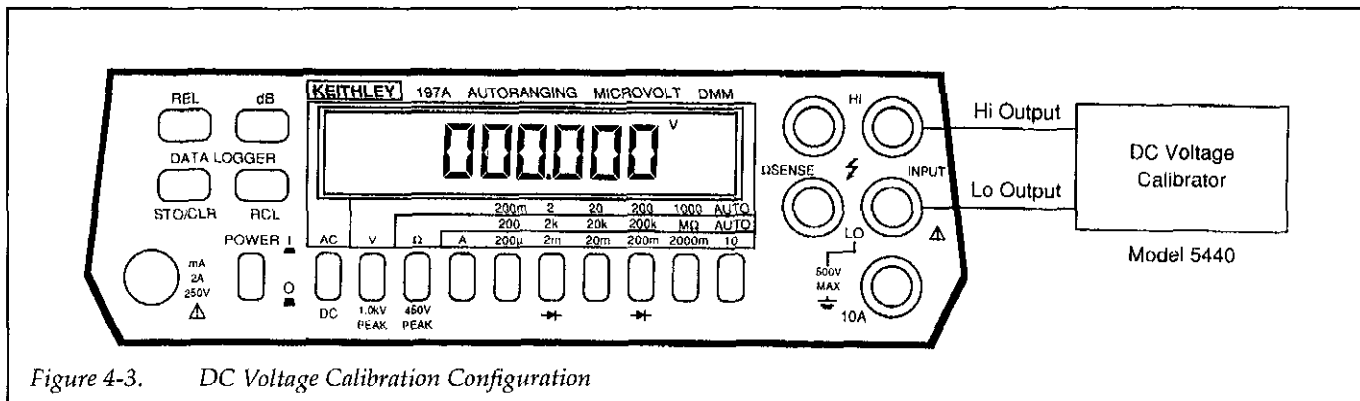

Figure 4-3. DC Voltage Calibration Configuration

The calibration mode is indicated by the "C" annunciator on the front panel display.

2. Select the 200mV range, short INPUT HI and LO, and press the REL button (REL annunciator is on).
3. Set the calibrator to output +190.000mV.
4. Adjust the display to read 190.000 with the use of the STO/CLR and RCL buttons. The STO/CLR button increments the displayed reading. The RCL button decrements the displayed reading. The longer either button is held in, the faster the displayed reading is modified.
5. Select the next range (2V) and set the calibrator output to +1.90000V.
6. Repeat step 4 to read 1.90000.
7. Reverse the calibrator leads in order to output -1.90000V.
8. Repeat step 4 to read -1.90000.
9. Repeat steps 2 through 4 for the remaining DC voltage ranges listed in Table 4-3.

Table 4-3. DC Voltage Calibration

Range	Calibrator Voltage	Model 197A Reading
200mV	+190.000mV	190.000mV
2 V	+1.90000 V	1.90000 V
2 V	-1.90000 V	-1.90000 V
20 V	+19.0000 V	19.0000 V
200 V	+190.000 V	190.000 V
1000 V	+1000.00 V	1000.00 V

4.6.5 AC Voltage Calibration

With the Model 197A still in the calibration mode ("C" annunciator on), connect the AC voltage calibrator to the

Model 197A as shown in Figure 4-4. Steps 1-6 must be performed in the exact sequence listed.

1. Select the AC voltage function and the 200mV range.
2. Set the calibrator to output 190.000mV at 500Hz.
3. Adjust the display using the STO/CLR and RCL buttons to read 190.000mV AC.
4. Press the dB button and verify that the dB annunciator is displayed.
5. Set the calibrator to output 19.000mV at 500Hz.
6. Adjust the displayed reading for 19.000mV.
7. Press the REL button and verify that the dB annunciator is off.
8. Repeat steps 2 and 3 for the remaining ranges using Table 4-4 as a guide.
9. Store the new cal constants before proceeding. See paragraph 4.6.8.

4.6.6 Frequency Compensation

The following section is to be used to determine if frequency compensation should be performed on the Model 197A, and to perform frequency compensation if necessary. This procedure requires the Model 197A to be warmed up for at least one hour. Note that this section is not to be used to verify that the Model 197A AC Voltage function is within specifications. If desired refer to Section 3 Performance Verification.

WARNING

Steps 1 through 4 require the use of high voltage. Take care not to come into contact with live circuits that could cause personal injury or death.

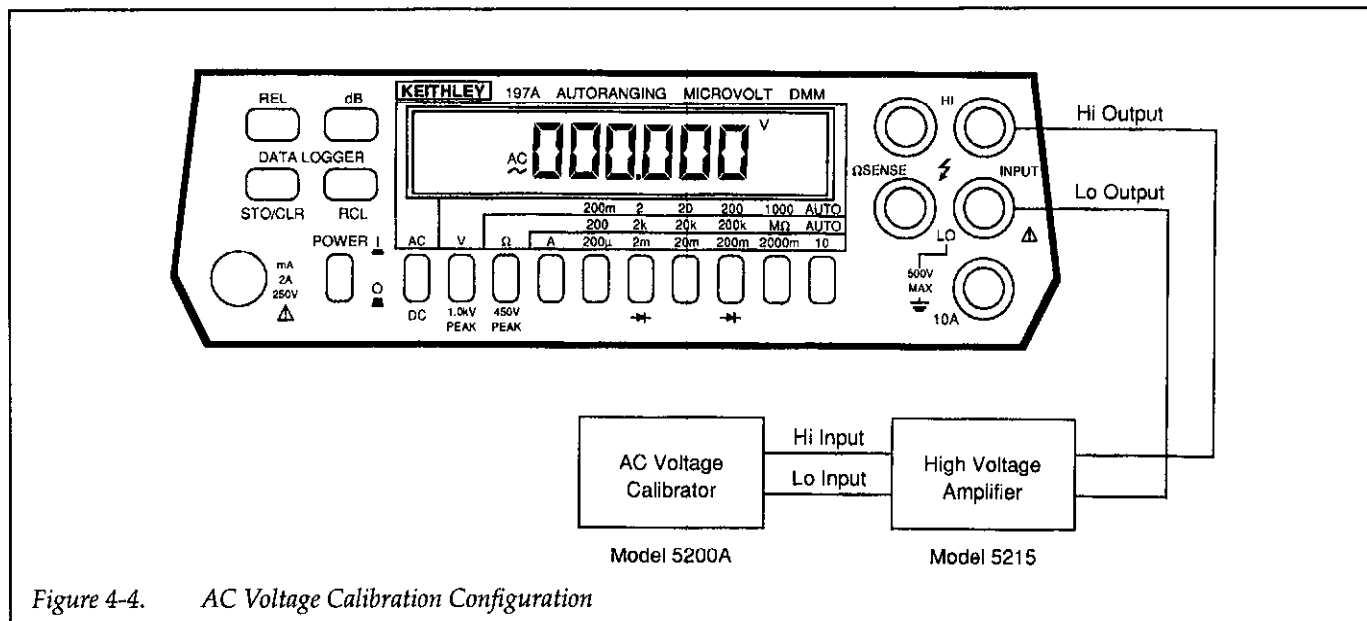

Figure 4-4. AC Voltage Calibration Configuration

1. Select the 1000VAC range and set the calibrator to output 500.00V at 500Hz. Press the REL button (REL annunciator turns on).
2. Set the calibrator to output 500.00V at 20kHz. Verify that the reading on the Model 197A is 000.00 ±150 counts. Press REL (REL annunciator turns off).
3. Set the calibrator to output 100.00V at 500Hz and select the 200VAC range. Press the REL button (REL annunciator turns on).
4. Set the calibrator to output 100.000V at 20kHz. Verify that the reading on the Model 197A is 000.000V ±200 counts. Press REL (REL annunciator turns off).
5. Set the calibrator to output 10.0000V at 500Hz and select the 20VAC range. Press REL (REL annunciator turns on).
6. Set the calibrator to output 10.0000V at 20kHz. Verify that the reading on the Model 197A is 00.0000 ±200 counts. Press REL (REL annunciator turns off).

If any of the above verifications are not met by the Model 197A, the top cover must be removed and three trimmer capacitors adjusted. The adjustments must be performed within 10 minutes after the top cover is removed so that the circuit components will be close to normal operating temperature. The three trimmer capacitors (C103, C105 and C107) are accessible through the shield. The shield and PC board must be secured to the bottom cover in order to prevent movement. This assembly can be secured with two screws and nuts (not supplied). Route the screws through the bottom cover through the two brown spacers to the shield. Secure the screws with the nuts.

Also, use a flat blade, insulated calibration tool for all the adjustments. Perform the following steps in the exact sequence listed.

WARNING

Steps 1 through 4 require the use of high voltage. Take care not to come into contact with live circuits that could cause personal injury or death.

1. Select the 1000VAC range and set the calibrator to output 500.00V at 500Hz. Press the REL button (REL annunciator turns on).
2. Set the calibrator to output 500.00V at 20kHz. Adjust C103 for a reading of 000.00 ±50 counts. Press REL (REL annunciator turns off).
3. Set the calibrator to output 100.00V at 500Hz and select the 200VAC range. Press REL (REL annunciator turns on).
4. Set the calibrator to output 100.00V at 20kHz. Adjust C105 for a reading on the Model 197A of 000.000V ±50 counts. Press REL (REL annunciator turns off).
5. Set the calibrator to output 10.0000V at 500Hz and select the 20VAC range. Press REL (REL annunciator turns on).
6. Set the calibrator to output 10.0000V at 20kHz. Adjust C107 for a reading on the Model 197A of 00.0000V ±50 counts.
7. Reinstall the top cover.

Table 4-4. AC Voltage Calibration

Range	Calibrator Voltage	Calibrator Frequency	Model 197A Reading
200mV	190.000mV	500Hz	190.000mV
200mV*	19.000mV	500Hz	19.000mV
2 V	1.90000 V	500Hz	1.90000 V
20 V	19.0000 V	500Hz	19.0000 V
200 V	190.000 V	500Hz	190.000 V

4.6.7 Resistance Calibration

With the Model 197A in the calibration mode ("C" annunciator on), select the ohms function and connect the calibrator to the Model 197A as shown in Figure 4-5. Use the following procedure and refer to Table 4-5 to calibrate the ohms function.

1. Select the 200Ω range and set the resistance calibrator to output zero ohms (short).
2. Press the REL button on the Model 197A. The REL annunciator appears on the display and the display reads zero (test lead compensation).
3. Set the calibrator to output 190Ω. Adjust the display using the STO/CLR and RCL buttons for a reading of 190.000Ω. Press REL (REL annunciator turns off).
4. Select the 2kΩ range and set the resistance calibrator to output zero ohms (short). Press REL (REL annunciator turns on).

5. Set the calibrator to output 1.9kΩ. Adjust the display for a reading of 1.90000kΩ.
6. Press the REL button and note that the REL annunciator turns off.
7. Select the 20kΩ range and set the resistance calibrator output zero ohms (short). Press REL (REL annunciator turns on).
8. Set the calibrator output to 19kΩ. Adjust the display for a reading of 19.0000kΩ. Press REL (REL annunciator turns off).
9. Repeat steps 7 and 8 for the 200k, 2M and 20M ranges using Table 4-5 as a guide. For these ranges use the configuration shown in Figure 4-6.

Table 4-5. Resistance Calibration

Range	Calibrator Voltage	Model 197A Reading
200Ω	190 Ω	190.000 Ω
2kΩ	1.9kΩ	1.90000kΩ
20kΩ	19kΩ	19.0000kΩ
200kΩ	190kΩ	190.000kΩ
2MΩ	1.9MΩ	1.90000kΩ
20MΩ	19MΩ	19.0000MΩ

NOTE

Four terminal resistance measurements need only be done when not using the REL feature.

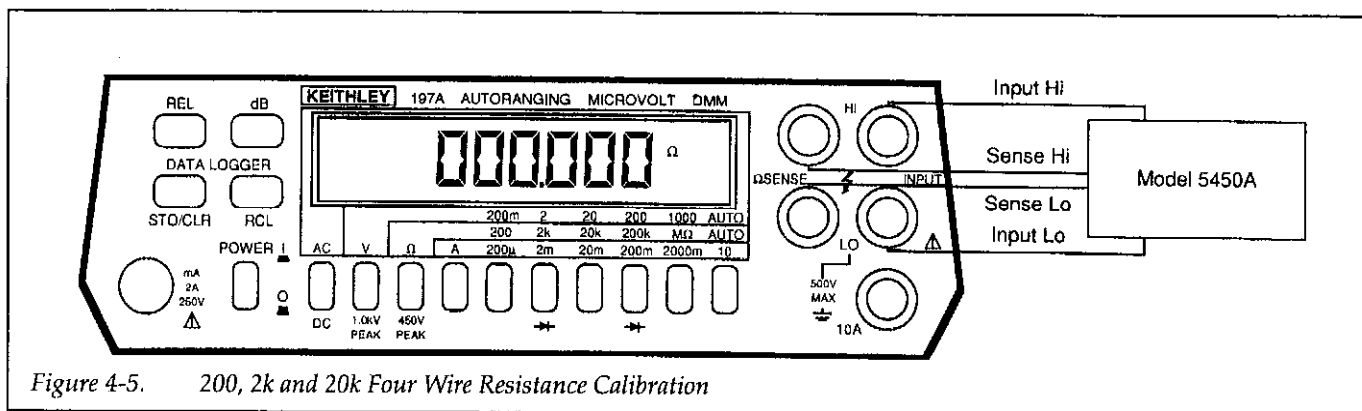

Figure 4-5. 200, 2k and 20k Four Wire Resistance Calibration

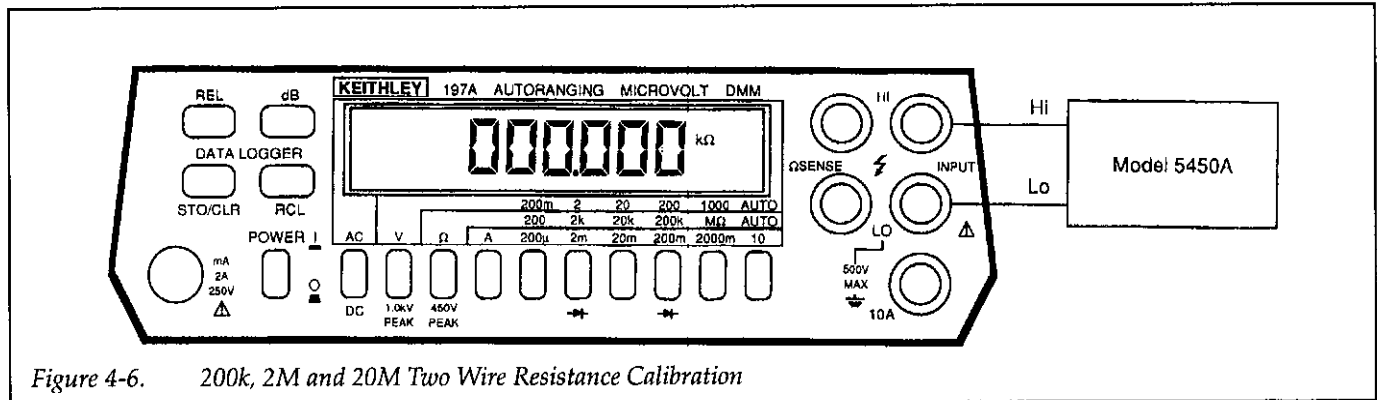

Figure 4-6. 200k, 2M and 20M Two Wire Resistance Calibration

4.6.8 Calibration Storage

To store the calibration constants, simultaneously press the REL and dB buttons until the message "Stor" is displayed. If instead the message "out" is displayed, then calibration storage was not enabled and the calibration constants will only be valid until the Model 197A is turned off. Temporary calibration is denoted by the flashing "C" annunciator.

To save calibration constants after "out" appears on the display, slide the calibration switch to ENABLED. Press REL and dB simultaneously until "CAL" appears on the display. Then simultaneously press REL and dB until "Stor" is displayed. The calibration constants are now stored and the Model 197A is ready for normal operation.



Service Form

Model No. _____ Serial No. _____ Date _____

Name and Telephone No. _____

Company _____

List all control settings, describe problem and check boxes that apply to problem. _____

- | | | |
|--|--|--|
| <input type="checkbox"/> Intermittent | <input type="checkbox"/> Analog output follows display | <input type="checkbox"/> Particular range or function bad; specify |
| <input type="checkbox"/> IEEE failure | <input type="checkbox"/> Obvious problem on power-up | <input type="checkbox"/> Batteries and fuses are OK |
| <input type="checkbox"/> Front panel operational | <input type="checkbox"/> All ranges or functions are bad | <input type="checkbox"/> Checked all cables |

Display or output (check one)

- | | |
|-----------------------------------|--|
| <input type="checkbox"/> Drifts | <input type="checkbox"/> Unable to zero |
| <input type="checkbox"/> Unstable | <input type="checkbox"/> Will not read applied input |
| <input type="checkbox"/> Overload | |

Calibration only Certificate of calibration required

Data required

(attach any additional sheets as necessary)

Show a block diagram of your measurement system including all instruments connected (whether power is turned on or not). Also, describe signal source.

Where is the measurement being performed? (factory, controlled laboratory, out-of-doors, etc.)

What power line voltage is used? _____ Ambient temperature? _____ °F

Relative humidity? _____ Other? _____

Any additional information. (If special modifications have been made by the user, please describe.)

Be sure to include your name and phone number on this service form.

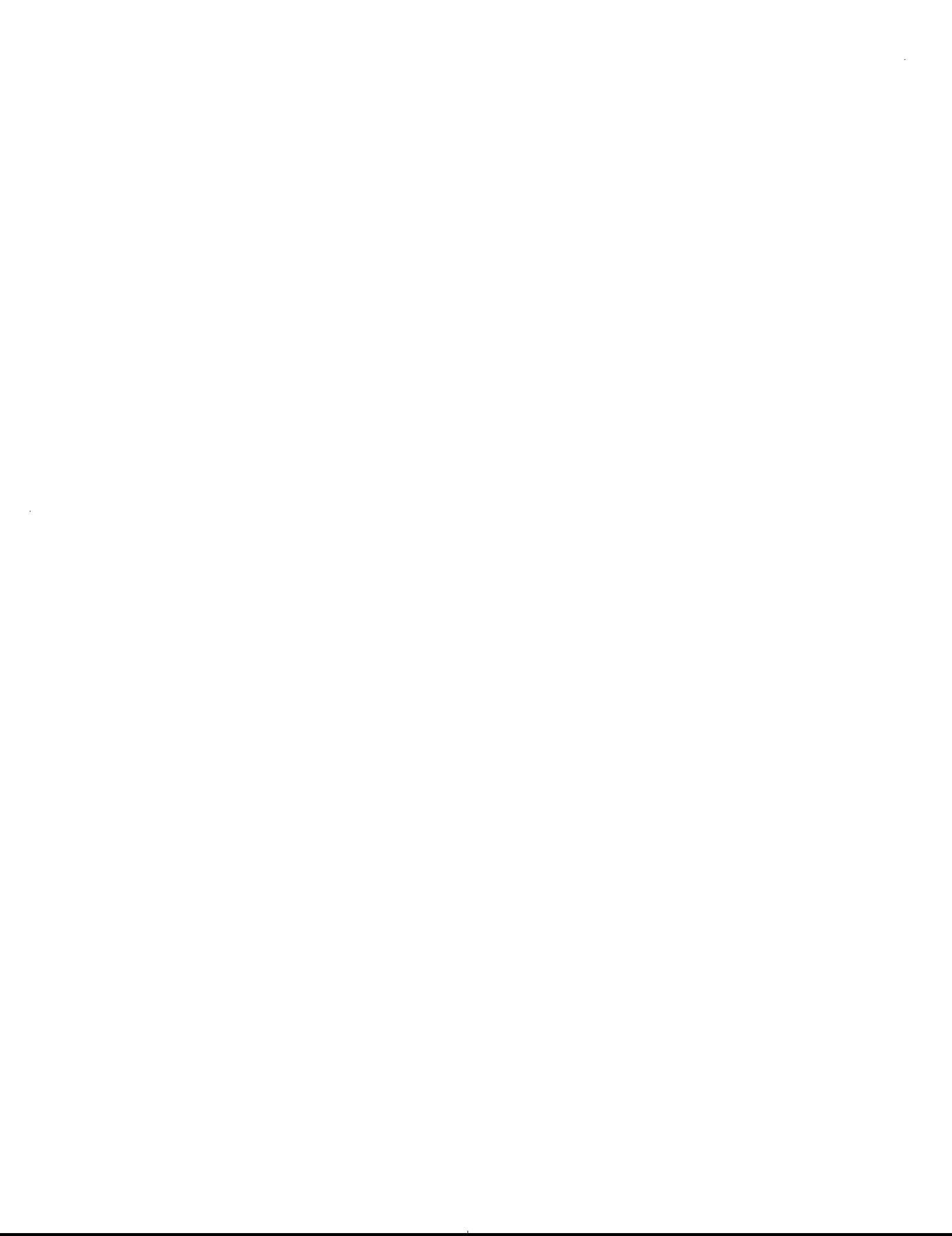

Specifications are subject to change without notice.

All Keithley trademarks and trade names are the property of Keithley Instruments, Inc. All other trademarks and trade names are the property of their respective companies.

KEITHLEY

Keithley Instruments, Inc.

BELGIUM: Keithley Instruments B.V.
CHINA: Keithley Instruments China
FRANCE: Keithley Instruments Sarl
GERMANY: Keithley Instruments GmbH
GREAT BRITAIN: Keithley Instruments Ltd.
INDIA: Keithley Instruments GmbH
ITALY: Keithley Instruments s.r.l.
KOREA: Keithley Instruments Korea
NETHERLANDS: Keithley Instruments B.V.
SWITZERLAND: Keithley Instruments SA
TAIWAN: Keithley Instruments Taiwan

28775 Aurora Road • Cleveland, Ohio 44139 • 440-248-0400 • Fax: 440-248-6168
1-888-KEITHLEY (534-8453) www.keithley.com

Bergensesteenweg 709 • B-1600 Sint-Pieters-Leeuw • 02/363 00 40 • Fax: 02/363 00 64
Yuan Chen Xin Building, Room 705 • 12 Yumin Road, Dewai, Madian • Beijing 100029 • 8610-6202-2886 • Fax: 8610-6202-2892
3, allée des Garays • 91127 Palaiseau Cédex • 01 64 53 20 20 • Fax: 01 60 11 77 26
Landsberger Strasse 65 • D-82110 Germering • 089/84 93 07-40 • Fax: 089/84 93 07-34
The Minster • 58 Portman Road • Reading, Berkshire RG30 1EA • 0118-9 57 56 66 • Fax: 0118-9 59 64 69
Flat 2B, WILLOCRISSA • 14, Rest House Crescent • Bangalore 560 001 • 91-80-509-1320/21 • Fax: 91-80-509-1322
Viale San Gimignano, 38 • 20146 Milano • 02-48 39 16 01 • Fax: 02-48 30 22 74
2FL., UR1 Building • 2-14 Yangjae-Dong • Seocho-Gu, Seoul 137-130 • 82-2-574-7778 • Fax: 82-2-574-7838
Postbus 559 • NL-4200 AN Gorinchem • 0183-635333 • Fax: 0183-630821
Kriesbachstrasse 4 • 8600 Dübendorf • 01-821 94 44 • Fax: 01-820 30 81
1FL., 85 Po Ai Street • Hsinchu, Taiwan, R.O.C. • 886-3-572-9077 • Fax: 886-3-572-9031