

KEITHLEY

Model 486

PICOAMMETER

Model 487

PICOAMMETER/SOURCE

QUICK REFERENCE GUIDE

INTRODUCTION

This quick reference guide contains descriptions of various features and information concerning the operation of the Model 486/487.

©1990, Keithley Instruments, Inc.
All rights reserved.
Cleveland, Ohio, U.S.A.
Document Number: 486-903-01 Rev. A

**Asyst is a registered trademark of Asyst Software technologies.
Hewlett-Packard is a registered trademark of Hewlett-Packard
Company.**

**IBM and AT are registered trademarks and PC/XT is a trademark
of International Business Machines, Inc.**

PC-488 is a registered trademark of Capital Equipment Corporation.

TABLE OF CONTENTS

SAFETY WARNINGS	5
ERROR MESSAGES	7
CURRENT MEASUREMENTS	8
VOLTAGE SOURCE (Model 487)	14
V/I OHMS MEASUREMENTS (Model 487)	19
MENU	21
FRONT PANEL TRIGGERING	22
EXTERNAL TRIGGERING	24
DATA STORE OPERATION	26
ANALOG OUTPUT	27
TALK-ONLY	28
IEEE-488 PROGRAMMING	29
Device-dependent Commands	29
Display Intensity	29
Reading Source	29
Zero Check and Correct	29
Display	30
V/I Ohms	30
Data Format	30
Hit Control	31
Self-Test	31
EOI and Bus Hold-off	31
Default Conditions or Calibration	32
SRQ	32
Data Store	32
Operate	33
Filters	33
Interval	33
Range	33
Integration	34

Trigger	34
Status	34
Voltage Source (487)	35
Delay	35
Execute	35
Terminator	35
Relative	36
Data Formats	36
SRQ Mask and Serial Poll Byte	40
Status Words	41

SAFETY WARNINGS

The following precautions should be observed before using Model 486/487. Refer to main manual for detailed safety information and complete operating instructions.

The Model 486/487 is intended for use by qualified personnel who recognize shock hazards and are familiar with the safety precautions required to avoid possible injury. Read over the instruction manual carefully before using the instrument.

Before operating the instrument, make sure the line cord is connected to a properly grounded power receptacle.

Exercise extreme caution when a shock hazard is present. Lethal voltages may be present on the test fixture or the Model 487 output jacks. The American National Standards Institute (ANSI) states that a shock hazard exists when voltage levels greater than 30V RMS or 42.4V peak are present. **A good safety practice is to expect that hazardous voltage is present in any unknown circuit before measuring.**

Inspect the connecting cables, test leads, and jumpers for possible wear, cracks, or breaks before each use.

For maximum safety, do not touch the Model 487 connections, test fixture, test cables or connections to any other instruments while power is applied to the circuit under test. Turn off all power and discharge all capacitors before connecting or disconnecting cables or jumpers. Also, keep the test fixture lid closed while power is applied to the device under test. Safe operation requires the use of the lid interlock.

Do not touch any object which could provide a current path to the common side of the circuit under test or power line (earth) ground.

Do not exceed the maximum signal levels of the instrument, as shown on the rear panel and as defined in the specifications and operation section of the instruction manual.

Connect the chassis of the test fixture to safety earth ground using #18 AWG or larger wire.

Instrumentation and accessories should not be connected to humans.

Maintenance should only be performed by qualified service personnel. Before performing any maintenance, disconnect the line cord and all test cables from the instrument.

ERROR MESSAGES

Table 1. Error Messages

Message	Description
NO DEFLT	Checksum error in default condition during power-up.
UNCAL	Checksum error in calibration during power-up
ROM ERROR	Failed ROM self-test.
RAM ERROR	Failed RAM self-test.
TRG OVERUN	Trigger overrun; instrument triggered while still processing a previous trigger.
CAL VALUE	Calibration value conflicts with the currently selected range.
CAL ERROR	Calibration value not within allowable limits.
CAL LOCK	Sent calibration command with calibration switch (CAL LOCK) disabled.
CAL ZCHK	Cannot calibrate picoammeter with zero check enabled.
INTERLOCK	Tried to put V-Source of Model 487 in operate while an enabled safety interlock switch is open.

CURRENT MEASUREMENTS

Current Ranges

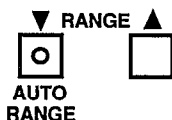

The available current ranges of the Model 486/487 are listed in Table 2.

Table 2. Current Ranges

Range	Maximum Reading (5-1/2d)	Maximum Overload*
2nA	2.19999nA	350Vdc
20nA	21.9999nA	350Vdc
200nA	219.999nA	350Vdc
2μA	2.19999μA	350Vdc
20μA	21.9999μA	50Vdc
200μA	219.999μA	50Vdc
2mA	2.19999mA	50Vdc

*Higher voltages require current to be limited to 3mA.

Autorange is enabled by pressing SHIFT and then AUTO RANGE in that order.

CAUTION

To avoid possible damage to the instrument, do not apply more than 50Vdc to the input when autorange is enabled (unless an external series resistor to limit current to 3mA is used).

Zero Check and Correct

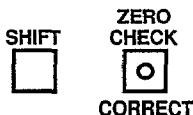

When zero check is enabled, the input amplifier is internally disconnected from the input connector of the instrument. A 100k Ω resistor shunts the input connector, and the instrument displays the offset of the selected range.

When zero correction is performed, the offset is measured and algebraically subtracted from every subsequent reading (including zero checked readings).

Zero check is enabled by pressing ZERO CHECK. Pressing ZERO CHECK a second time disables the feature.

When zero correction is performed, only the present range is zero corrected. Before making measurements, it is recommended that each current range be zero corrected.

To perform zero correction:

1. Enable zero check.
2. To perform zero correction, press SHIFT and then CORRECT in that order.

Filters



Filtering is used to stabilize noisy measurements. The Model 486/487 has two available filters; a digital filter and an analog filter. The digital filter bases the reading on the weighted average of a number of measurement conversions. The analog filter is a simple RC filter whose time constant varies with the selected range.

When the filter is enabled, the selected filter(s) (digital filter, analog filter or both) will be used.

To check or change the filter selection:

1. Press SHIFT and then FILTER SELECT in that order. One of the following messages will be displayed to indicate the currently selected filter(s):

FILTER	DIGITAL	(Digital filter selected)
FILTER	ANALOG	(Analog filter selected)
FILTER	DIG+AN	(Both digital and analog filters selected)

2. To select a different filter, use the rotary knob or the ◀ and ▶ keys to display the desired filter selection.
3. Enter the displayed filter selection by pressing SHIFT and then FILTER SELECT.

Rel



The rel (relative) feature serves as a means of baseline suppression by allowing a stored offset value to be subtracted from subsequent readings. When rel is enabled, the instrument takes the currently displayed reading as a baseline value. All subsequent readings represent the difference between the applied signal level and the stored baseline.

A baseline can be established for both current and V/I ohm measurements and is "remembered" by both functions.

Rel is enabled by pressing the REL key. Pressing REL a second time disables the feature.

Making Current Measurements

To make current measurements:

1. Select a current range that is appropriate for the expected measurement or enable autorange (press SHIFT and then AUTO RANGE).
2. Enable zero check and, if the display is not zeroed, perform zero correction by pressing SHIFT and then CORRECT.
3. Connect the current to be measured to the input of the Model 486/487 (see Figures 1 and 2).
4. Disable zero check and read the measured current on the display of the Model 486/487.

Input Connector

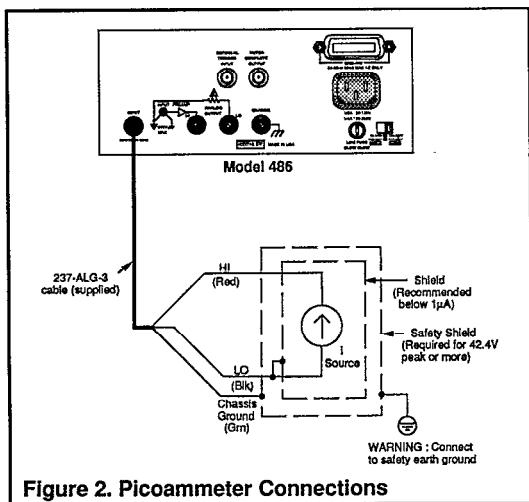
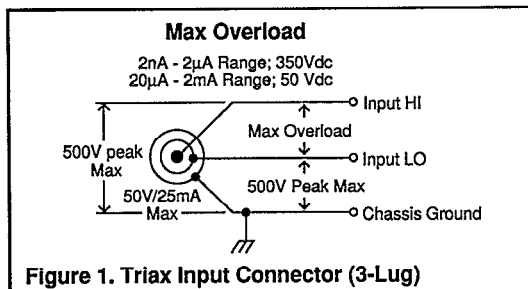

VOLTAGE SOURCE

(Model 487)

CAUTION

The voltage source may float. However, neither V-Source terminal may ever be more than 500V above chassis.

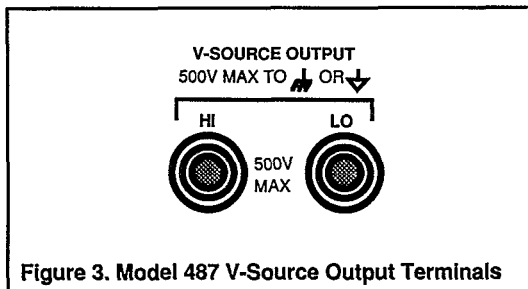

Table 3. Model 487 V-Source

Range	Maximum Output	Step Size
50V	50.500V	1mV
500V	505.00V	10mV

Test Fixture and Interlock

The voltage source of the Model 487 is designed to be used with a test fixture that incorporates a safety interlock switch, such as the Keithley Models 8002A High Resistance Test Fixture. By using the interlock feature, the Model 487 cannot source voltage when the lid of the test fixture is open or ajar.

Adjusting V-Source Level

The rotary knob and the ◀ and ▶ keys are used to adjust the V-Source level and select range.

WARNING

With the instrument in operate (OPERATE indicator on), the displayed voltage level (possibly hazardous) will be applied to the output terminals of the V-Source. The V-Source should be kept in standby until ready to safely source voltage to a load.

Preset



Preset allows the V-Source to be toggled between two preset values.

To preset a V-Source level:

1. Enable preset by pressing PRESET. Indicator will turn on.
2. Adjust the V-Source to the desired range and level.
3. Disable preset by again pressing PRESET.
4. Whenever preset is enabled, V-Source will adjust to the value and range set in step 2.

I-Limit

The V-Source has current limit (I-limit) capabilities to protect the instrument and external current sensitive circuitry from possible damage. The V-Source can be set for an I-limit of $25\mu\text{A}$ or 2.5mA .

When I-limit occurs, the OPERATE indicator will flash.

To set I-limit:

1. Keep pressing and releasing MENU until the currently selected I-limit is displayed:

ILIMIT 25 μ A
or
ILIMIT 2.5mA

2. Use the rotary knob to display the desired I-limit value.
3. to enter the displayed I-limit, press MENU.

Operate

500V 2mA
MAX
OPERATE

FLASHES
IN I LIMIT

The OPERATE key toggles the output between standby and operate. In standby, the V-Source is removed from the rear panel output terminals. In operate, V-Source is applied to the output terminals.

V-Source Operation

1. While in standby, connect the V-Source as shown in Figure 4.
2. Use the rotary knob, and the ◀ and ▶ keys to set the desired voltage range and level.
3. Select the appropriate I-limit ($25\mu\text{A}$ or 2.5mA).
4. Press Operate.
5. To disable the V-Source, again press OPERATE.

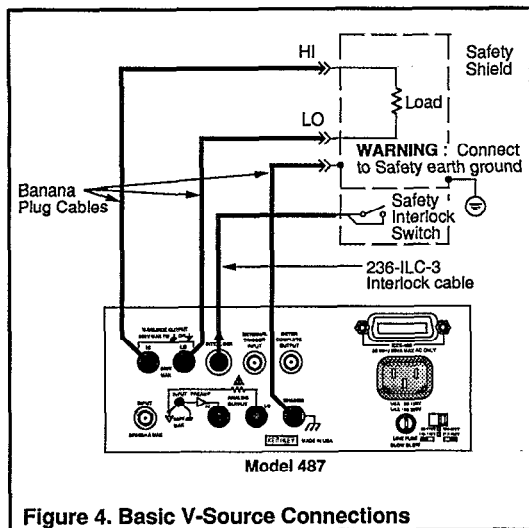

V/I OHMS MEASUREMENTS

(Model 487)

By using the V-Source in conjunction with its picoammeter, the Model 487 can make resistance measurements as high as $5.05 \times 10^{16} \Omega$. With V/I ohms selected, the resistance is automatically calculated from the applied voltage and measured current ($R=V/I$) and displayed (in ohms) on the Model 487.

The V/I ohms function is enabled by pressing SHIFT and then OHMS.

To make V/I ohms measurements:

1. With zero check enabled and the V-Source in standby, connect the circuit shown in Figure 5.
2. Select a current range that gives the nearest full scale reading or autorange, and perform zero correction by pressing SHIFT and then CORRECT.
3. Set the V-Source to 0V on the range that will be used and press OPERATE to enable the source output.
4. Press REL to cancel offset current.
5. Set the V-Source to the desired voltage level.
6. Disable zero check. The current measurement will be displayed.
7. Enable V/I ohms by pressing SHIFT and then OHMS.
8. To measure from a baseline resistance, enable rel while in V/I ohms.

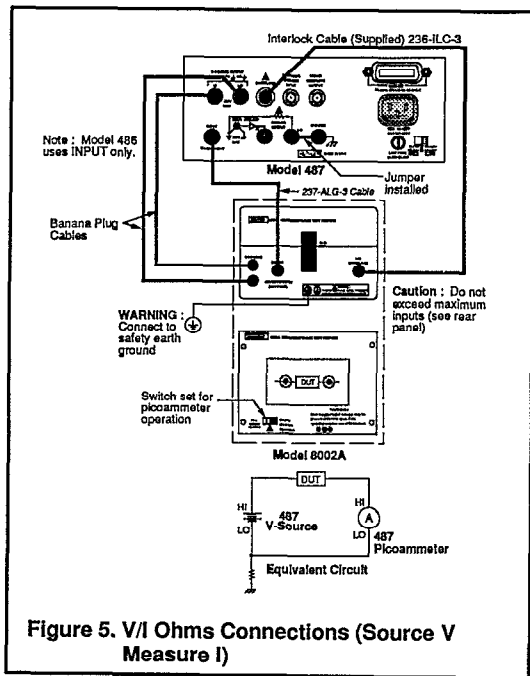

Figure 5. V/I Ohms Connections (Source V Measure I)

MENU

The menu items are listed in Table 4. In general, each press of the MENU key displays a menu item in the order shown in the table. The available selections of the displayed menu items are selected and displayed with the rotary knob or the ◀ and ▶ keys. The displayed option of the displayed menu item is selected by again pressing MENU. To exit the menu, press SHIFT and then EXIT.

Table 4. MENU Items

Menu Item	Description
DATA STORE	Arm data store and set buffer size
DATA RECL	Recall data stored in buffer
ILIMIT	Set current limit; 25 μ A or 2.5mA (Model 487 only)
INTEGRATE	Set integration period; fast or line cycle (50 or 60Hz)
IEEE-488	Set IEEE-488 address 0-30 or se- lect Talk-only
DEFAULTS	Save steps as power-up defaults, return to previously saved defaults, or return to factory defaults
SELFTEST	Test display and memory elements
DEBUG	Troubleshooting mode
CALIBRATE	Calibrate current range
CAL V SRC	Calibrate V-Source (Model 487 only)

FRONT PANEL TRIGGERING

Trigger Setups

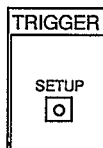

In general, trigger setup (mode, internal, delay and sources) is performed by:

1. Press SETUP to display the setup.
2. Use the rotary knob to display the desired option of the setup.
3. Press SHIFT and then SETUP to select the displayed setup.

Trigger Mode

In the one-shot mode, a separate trigger is required to initiate each reading. For the multiple mode, however, only a single trigger is required.

Trigger Interval

Determines the time period between individual readings when the instrument is in the multiple trigger mode.

The trigger interval can be set from 10msec to 999.999sec.

Trigger Delay

Time from the trigger point until the unit takes a reading. In the multiple trigger mode, the delay period affects only the first conversion; however in the one-shot trigger mode, the delay period affects every conversion.

The Model 486/487 can be programmed for a delay interval from 0sec to 999.999sec in 1msec increments.

Trigger Sources

Available trigger source selections:

TRIG SRC	EXTERNAL
TRIG SRC	OPERATE
TRIG SRC	BUS X
TRIG SRC	GET
TRIG SRC	TALK

EXTERNAL TRIGGERING

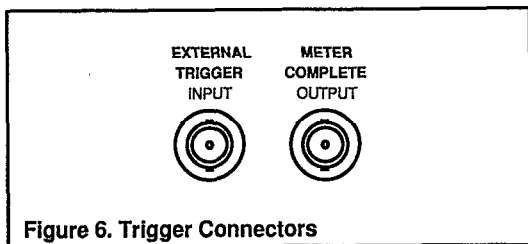

Figure 6. Trigger Connectors

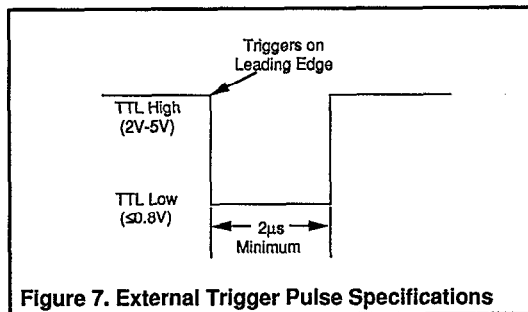
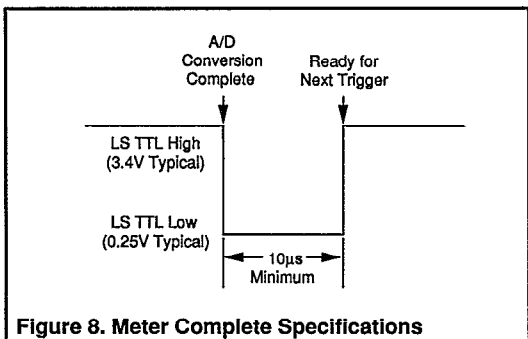

Figure 7. External Trigger Pulse Specifications



DATA STORE OPERATION

Storing Data

1. Set the trigger mode, interval and delay.
2. Arm data store and set buffer size as follows:
 - A. Press MENU until the data store is selected, and use the rotary knob to display the following:

DATA STORE YES

- B. Press MENU to display buffer size.
 - C. Use the rotary knob or the ◀ and ▶ keys to display the desired buffer size value.
 - D. Press MENU.
3. Press TRIGGER to initiate storage.

Recalling Data

1. Press MENU until data recall is selected, and use the rotary knob to display the following message:

DATA RECL YES

2. Press MENU. The reading stored in the first memory location will be displayed.
3. For sequential access, use the rotary knob.
4. To access a reading at a particular memory location, adjust the display to the desired location value.
5. To exit data recall, press SHIFT and then EXIT.

ANALOG OUTPUT

The Model 486/487 has a non-inverting analog output. For a 200,000 count input, the analog output will be 2V.

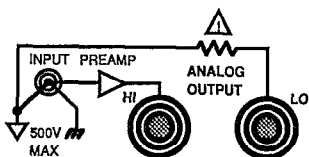

TALK-ONLY

In talk-only, the Model 486/487 will talk continuously on the IEEE-488 bus and output readings to a listen-only device whenever a measurement conversion occurs.

To place the Model 486/487 in talk-only:

1. Press and release MENU until the present IEEE-488 selection is displayed.
2. Use the rotary knob to display talk-only as follows:

IEEE-488

TALK ONLY

3. Press MENU. The TALK indicator will turn on.
4. Exit the menu by pressing SHIFT and then EXIT.

IEEE-488 PROGRAMMING

Device-dependent Commands

Display Intensity	
A0	Normal display
A1	Dim display
A2	Turn display off

Reading Source	
B0	Readings from A/D
B1	Single reading from data store
B2	All readings from data store
B3	Maximum reading from data store
B4	Minimum reading from data store

Zero Check and Correct	
C0	Disable zero check
C1	Enable zero check
C2	Enable zero check and perform zero correction

Display

Da	Display up to 18 character (a) message
D	Cancel display mode

V/I Ohms

F0	Disable V/I ohms
F1	Enable V/I ohms

Data Format

G0	ASCII rdgs with prefix
G1	ASCII rdgs without prefix
G2	ASCII rdgs and buffer locations with prefix
G3	ASCII rdgs and buffer locations without prefix
G4	Binary rdgs: IEEE Std 754 single-precision, bytes reversed for Intel CPUs
G5	Binary rdgs: IEEE Std 754 single-precision, bytes in normal order for Motorola CPUs
G6	Binary rdgs: counts and exponent, bytes reversed for Intel CPUs
G7	Binary rdgs: counts and exponent, bytes in normal order for Motorola CPUs

Hit Control

H1	Hit DISPLAY INTENSITY key
H2	Hit LOCAL key
H3	Hit SHIFT key
H4	Hit MENU key
H5	Hit ZERO CHECK key
H6	Hit FILTER key
H7	Hit RANGE ▼ key
H8	Hit REL key
H9	Hit RANGE ▲ key
H10	Hit SETUP key
H11	Hit TRIGGER key
H12	Hit OPERATE key (487)
H13	Hit PRESET key (487)
H14	Hit ◀
H15	Hit ▶
H16	Hit Rotary Knob counterclockwise
H17	Hit Rotary Knob clockwise

Self-Test

J0	Perform ROM/RAM self-test
J1	Perform display and ROM/RAM self-test

EOI and Bus Hold-off

K0	Enable EOI and bus hold-off on X
K1	Disable EOI, enable bus hold-off on X
K2	Enable EOI, disable bus hold-off on X
K3	Disable both EOI and bus hold-off on X

Default Conditions or Calibration

L0	Return to factory default conditions and save (L1)
L1	Save present states as default conditions
L2	Return to saved default conditions
L3,v	Calibrate present measurement range using "v"; v=-2mA to +2mA
L4	Calibrate zero on present voltage source range (Model 487 only)
L5	Calibrate full scale on present voltage source range (Model 487 only)
L6	Prepare to calibrate present voltage source range (Model 487 only)

SRQ

M0	Disable SRQ
M1	Reading overflow
M2	Data store full
M4	Data store half full
M8	Reading done
M16	Ready
M32	Error
M128	Voltage Source Error (Model 487 only)

Data Store

N0	Arm data store; wrap around operation
Nn	Arm data store; set buffer size "n" where n = 1 to 512

Operate	
O0	Place voltage source in standby
O1	Place voltage source in operate

Filters	
P0	Disable digital and analog filters
P1	Enable digital filter; disable analog filter
P2	Disable digital filter; enable analog filter
P3	Enable digital and analog filters

Interval	
Q0	175msec (factory default)
Qn	Set to "n" seconds. n=0.010sec to 999.999sec

Range	
R0	Enable autorange
R1	Select 2nA range
R2	Select 20nA range
R3	Select 200nA range
R4	Select 2 μ A range
R5	Select 20 μ A range
R6	Select 200 μ A range
R7	Select 2mA range
R8	No range
R9	No range
R10	Disable autorange

Integration

S0	Fast integration; 1.6msec at 4-1/2 digit resolution
S1	Line cycle integration; 16.67msec (60Hz) or 20msec (50Hz) at 5-1/2 digit resolution

Trigger

T0	Multiple on Talk
T1	One-shot on Talk
T2	Multiple on GET
T3	One-shot on GET
T4	Multiple on X
T5	One-shot on X
T6	Multiple on External Trigger
T7	One-shot on External Trigger
T8	Multiple on Operate (487)
T9	One-shot on Operate (487)

Status

U0	Send machine status word
U1	Send error status word
U2	Send model number and firmware revision
U3	Send calibration value
U4	Send interval
U5	Send delay
U6	Send relative value for current
U7	Send relative value for V/I ohms
U8	Send voltage source value (487)
U9	Send voltage source error status word (487)

Voltage Source (487)

Vn,r,l Specify voltage source level "n" in volts,
range "r" and limit "l"
n: -505 to +505
r: 0 = 50V range; 1 = 500V range
l: 0 = 20 μ A limit; 1 = 2mA limit

Delay

Wn Delay trigger "n" seconds; n = 0 to
999.999sec

Execute

X Execute other device-dependent com-
mands

Terminator

Y0 CR LF
Y1 LF CR
Y2 CR
Y3 LF
Y4 None

Relative	
Z0	Disable relative
Z1	Enable relative using present reading as baseline
Z2,V	Enable relative using "v" as baseline; v = -2mA to +2mA for current = 0Ω to 50.5PΩ for V/I ohms
Z3	Enable relative using the baseline previously defined

Data Formats

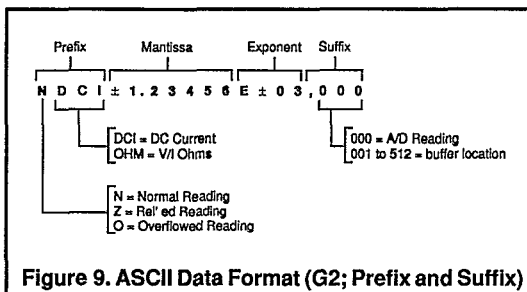

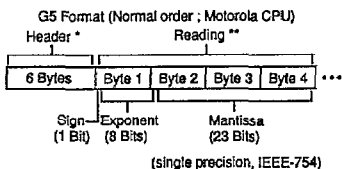

G4 Format (Reverse order ; Intel CPU) : Reading bytes sent in reverse order ; Header*, Byte 4, Byte 3, Byte 2, Byte 1

*Headers for the G4 and G5 formats are shown in Fig. 4-4

** When recalling data from the buffer, one header is followed by one or more readings, depending on buffer size.

Figure 10. G4 and G5 Binary Data Formats (IEEE Std. 754)

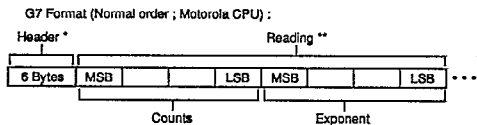
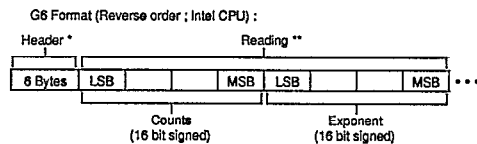

* Headers for the G6, and G7 formats are shown in Fig. 4-4

** When recalling data from the buffer, one header is followed by one or more readings, depending on buffer size.

NOTE : True reading = Counts X 10^{Exponent}

**Figure 11. G6 and G7 Binary Data Formats
(Counts/Exponent)**

G5 and G7 Header (6 bytes) :

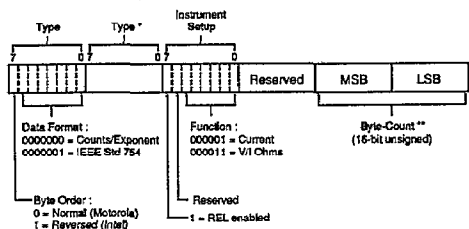

G4 and G6 Header (5 bytes) :

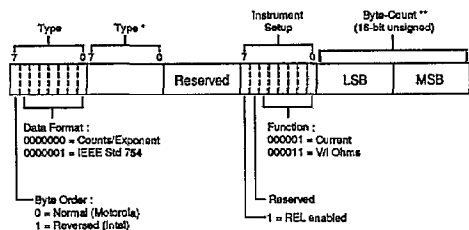

* Same as first type byte.

** Provides byte count for readings after header (does not include terminators).

Figure 12. Headers for Binary Formats

SRQ Mask and Serial Poll Byte

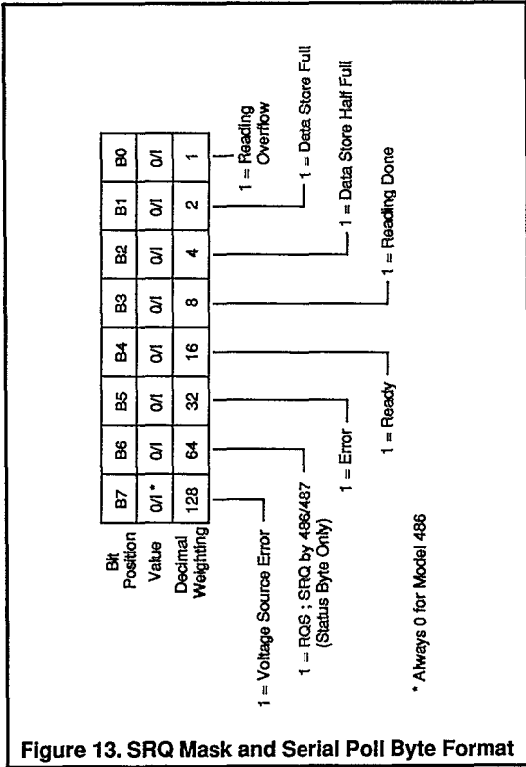

Status Words

U0 Machine Status Word

Model 486: 486 A0 B0 C1 G0 H** J0 K0 M000 N000
P3 R11 S1 T6 Y0 Z0 c*

Model 487: 487 A0 B0 C1 F0 G0 H** J0 K0 M000
N000 O0 P3 R11 S1 T6 V01 Y0 Z00 c*

*Calibration switch (CAL LOCK) position;

**Last pressed key

DISPLAY INTENSITY (A)

0=Normal

1=Dim

2=Off

READING SOURCE (B)

0=A/D Reading

1=One data store reading

2=All data store reading

3=Max data store reading

4=Min data store reading

ZERO CHECK and CORRECT (C)

0=Zero check disabled

1=Zero check enabled

V/I OHMS (F)

0=V/I Ohms disabled

1=V/I Ohms enabled

DATA FORMAT (G)

0=Rdg with prefix (ASCII)

1=Rdg without prefix (ASCII)

2=Rdg and buffer location
with prefix (ASCII)

3=Rdg and buffer location
without prefix (ASCII)

4=Binary rdg – IEEE Std 754
single – precision, bytes
reversed for Intel CPUs

5=Binary Rdg – IEEE Std 754
single – precision, bytes in
normal order for Motorola
CPUs

6=Binary Rdg – counts and
exponent, bytes re-
versed for Intel CPUs

7=Binary Rdg – Counts and
exponent, bytes in normal
order for Motorola CPUs

Figure 14. U0 Machine Status Word (Factory Defaults Shown)

U0 Machine Status Word (cont.)

HIT CONTROL (H)

- 00=POWER*
- 01=DISPLAY INTENSITY*
- 02=LOCAL*
- 03=SHIFT*
- 04=MENU*
- 05=ZERO CHECK*
- 06=FILTER*
- 07=RANGE▼*
- 08=REL*
- 09=RANGE▲*
- 10=SETUP*
- 11=TRIGGER*
- 12=OPERATE*
- 13=PRESET*
- 14=◀*
- 15=▶*
- 16=Knob rotated CCW
- 17=Knob rotated CW
- *Last pressed

SELF-TEST (J)

- 0=No errors
- 1=ROM error
- 2=RAM error
- 3=ROM and RAM error

EOI & BUS HOLD-OFF (K)

- 0=EOI and Hold-off
- 1=No EOI and Hold-off
- 2=EOI and no Hold-off
- 3=No EOI and no Hold-off

SRQ (M)

- 000=Disabled
- 001=Reading overflow
- 002=Data Store Full

SRQ (M) (cont)

- 004=Data Store 1/2 Full
- 008=Reading Done
- 016=Ready
- 032=Error
- 128=Voltage Source Error

DATA STORE SIZE (N)

- 000=Wrap around
- nnn=001 to 512

OPERATE (O)

- 0=V-Source in Standby
- 1=V-Source in Operate

FILTERS (P)

- 0=Both Filters Disabled
- 1=Digital Filter Enabled,
Analog Filter Disabled
- 2=Digital Filter Disabled
Analog Filter Enabled
- 3=Both Filters Enabled

RANGE (RMN)

- m: 0 = Autorange Disabled
- 1=Autorange Enabled
- n: 1=2nA range
- 2= 20nA range
- 3=200nA range
- 4=2μA range
- 5=20μA range
- 6=200μA range
- 7=2mA

INTEGRATION PERIOD (S)

- 0=Fast (4-1/2d)
- 1=Line cycle (5-1/2d)

U0 Machine Status Word (cont.)

TRIGGER (T)

- 0=Multiple on Talk
- 1=One-shot on Talk
- 2=Multiple on GET
- 3=One-shot on GET
- 4=Multiple on X
- 5=One-shot on X
- 6=Multiple on External Trigger
- 7=One-shot on External Trigger
- 8=Multiple on Operate
- 9=One-shot on Operate

VOLTAGE SOURCE (Vmn)

- m: 0 = 50V range
- 1 = 500V range
- n: 0 = 25 μ A Limit
- 1 = 2.5mA Limit

TERMINATOR (Y)

- 0=CR LF
- 1= LF CR
- 2=CR
- 3=LF
- 4=None

RELATIVE (Zm or Zmn)

- m: 0=Current Rel Disabled
- 1=Current Rel Enabled
- n: 0=V/I Ohms Rel Disabled
- 1=V/I Ohms Rel Enabled

CAL LOCK (c)

- 0=Switch in disabled (locked) position
- 2=Switch in enable (locked) position

U2 through U8 Status Words

U2 Model Number and Firmware Revision

e.g. 486A03

U3 Calibration Value

e.g. CV=+0.00000E-05A

U4 Trigger Interval

e.g. TI=001.236E+00S

U5 Trigger Delay

e.g. TD=002.000E+00S

U6 Relative Value (Current)

e.g. RV=+1.00000E-03A

U7 Relative Value (V/I Ohms)

e.g. RV=+1.00000E+02OHM

U8 Voltage Source Value

e.g. VS=+20.000E+00V

Figure 16. U2 through U8 Status Words

U9 Voltage Source Error Status

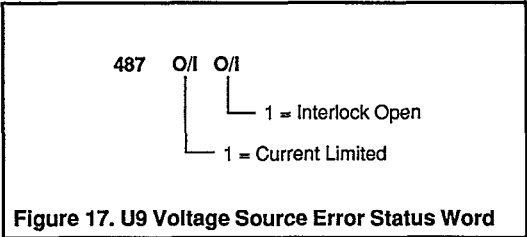

KEITHLEY

Keithley Instruments, Inc.
28775 Aurora Road
Cleveland, Ohio 44139

Printed in the U.S.A.