

KENWOOD

HF TRANSCEIVER

TS-130S

INSTRUCTION MANUAL

TRIO-KENWOOD CORPORATION

INTRODUCTION

You are the owner of our latest product, the new TS-130S(V) transceiver. Please read this instruction manual carefully before placing your transceiver in service. The unit has been carefully engineered and manufactured to rigid quality standards, and should give you satisfactory and dependable operation for many years.

AFTER UNPACKING:

- Shipping container:
Save the boxes and packing in the event your unit needs to be transported for remote operation, maintenance, or service.
- The following explicit definitions apply in this manual:
Note: If disregarded inconvenience only, no risk of equipment damage or personal injury.
Caution: Equipment damage may occur, but not personal injury.

CONTENTS

SPECIFICATIONS	3
SECTION 1. FEATURES	4
SECTION 2. PREPERATION FOR USE	
2.1 ACCESSORIES	4
2.2 INSTALLATION	4
2.3 INTERCONNECTION	5
SECTION 3. CONTROLS	
3.1 FRONT PANEL	7
3.2 REAR TOP PANEL	9
SECTION 4. OPERATION	
4.1 RECEPTION	10
4.2 TRANSMISSION	11
4.3 VOX OPERATION	12
4.4 SEMI-BREAK-IN OPERATION	13
4.5 OPRATION WITH A LINEAR AMPLIFIER	13
4.6 FIXED CHANNEL OPERATION	13
4.7 CW OPERATION	14
4.8 MOBILE OPERATION	15
4.9 FIXED STATION OPERATION	17
4.10 DIGITAL DISPLAY CALIBRATION	17
4.11 ANALOG DIAL CALIBRATION	17
SECTION 5. ADDITIONAL INFORMATION	18
SECTION 6. OPTIONAL ACCESSORIES	20
INTERNAL VIEWS	22
BLOCK DIAGRAM	23
SCHEMATIC DIAGRAM	24~31

TS-130S, TS-130V SPECIFICATIONS

[GENERAL]

Frequency Ranga:

80 meter band	3.5 ~ 4.0 MHz
40 meter band	7.0 ~ 7.3 MHz
*30 meter band	10.1 ~ 10.15 MHz (10.0 MHz Receiving only)
20 meter band	14.0 ~ 14.35 MHz
*17 meter band	18.068 ~ 18.168 MHz
15 meter band	21.0 ~ 21.45 MHz
*12meter band	24.89 ~ 24.99 MHz
10 meter band	28.0 ~ 29.7 MHz

Mode:

SSB/CW

Power Requirement:

TS-130S	TS-130V
RX: 0.7A 13.8V DC	RX: 0.7A 13.8V DC
TX: 18A 13.8V DC	TX: 4A 13.8V DC

Dimensions:

TS-130S	TS-130V
241 (9.6) W × 94 (3.8) H × 293 (11.7) D mm	241 (9.6) W × 94 (3.8) H × 235 (9.4) D mm (inch)

Weight:

TS-130S	TS-130V
5.6 kg (12.4 lbs)	4.9 kg (10.8 lbs)

[TRANSMITTER]

Final Power Input:

TS-130S	TS-130V
80 — 15 meter band 200 W PEP for SSB operation 160 W DC for CW operation	25W PEP for SSB operation 20W DC for CW operation
10 meter band 160 W PEP for SSB operation 140 W DC for CW operation	25W PEP for SSB operation 20W DC for CW operation

Audio Input Impedance:

500Ω ~ 50 kΩ

RF Output Impedance:

50Ω

Frequency Stability:

Within 100 Hz during any 30-minute period after warmup
Within ±1 kHz during the first hour after 1 minute of warmup

Carrier Suppression:

Better than 40 dB

Sideband Suppression:

Better than 50 dB

Spurious Radiation:

Better than 40 dB

Harmonic Radiation:

Better than 40 dB

[RECEIVER]

Receiver Sensitivity:

0.25μV at 10 dB S+N/N

Image Ratio:

Better than 50 dB

IF Rejection:

Better than 70 dB

Receiver Selectivity:

SSB/CW WIDE

2.4 kHz (−6 dB), 4.2 kHz (−60 dB)

SSB NARROW

1.8 kHz (−6 dB), 3.3 kHz (−60 dB) with optional YK-88SN filter

CW NARROW

500 Hz (−6 dB), 1.5 kHz (−60 dB) with optional YK-88C filter

270 Hz (−6 dB), 1.1 kHz (−60 dB) with optional YK-88CN filter

Audio Output Impedance:

4 ~ 16Ω

Audio Output:

1.5 W

NOTE: Circuit and ratings may change without notice due to developments in technology.

* Will transmit on the new 30, 17, and 12 meter bands. Diodes installed for preventing accidental transmission before government amateur arthorization.

SECTION 1. FEATURES

1. SINGLE-CONVERSION SYSTEM USING PLL CIRCUITRY

The single-conversion system, with a unique Phase Locked Loop circuit, FET balanced mixers and MOS FET's, assures excellent spurious and intermod characteristics.

2. BUILT-IN DIGITAL DISPLAY

The digital display affords easy reading of operating frequency to an accuracy of 100 Hz on any band and any mode.

3. BUILT-IN IF SHIFT CIRCUIT (Passband Tuning)

An IF SHIFT system is built into the transceiver to allow shifting the IF passband, thereby eliminating adjacent channel interference.

4. 3.5 ~ 29.7 MHz BAND

The transceiver is designed to operate on LSB/USB/CW in the 3.5 ~ 29.7 MHz bands. As supplied, the 10, 18, and 24.5 MHz bands are for reception only.

5. COMPACT, LIGHTWEIGHT DESIGN

The TS-130S(V) has many advanced features, yet it is compact and lightweight, suitable for mobile and field operations as well as fixed-station operation.

6. EASY OPERATION

All controls and switches are carefully arranged for ease of operation, ensuring convenience and versatility.

7. ALL SOLID-STATE DESIGN

The all solid-state, compact unit features a wide-band final stage, eliminating the need for peaking controls.

8. FOUR FIXED CHANNELS

Four FIXED channels can be installed, one for each of 7, 14, 21 and 28 MHz bands. The 3.5 MHz and 28 MHz FIXED XTAL position can be exchanged by simply moving a connector on the AF-GEN unit. The 10 and 18 MHz bands are shared by the 14 MHz band, and the 24.5 MHz band is shared by the 28 MHz band.

9. FULL RANGE OF AUXILIARY FUNCTIONS

Equipped with VOX, balanced-gate noise blanker for pulse noise rejection, a 25 kHz marker, and processor circuits.

10. SSB narrow filter YK-88SN

An optional SSB narrow filter YK-88SN can be installed. (Reception only)

11. OPTIONAL CW FILTERS YK-88C AND YK-88CN

The TS-130S(V) permits use of the optional YK-88C or YK-88CN CW filter (Reception only). CW semi-break-in operation is provided using the built-in VOX and CW side-tone circuits.

12. WIDE VARIETY OF OPTIONAL ACCESSORIES

The following optional accessories are available: Regulated power supply (PS-30) for the TS-130S, or (PS-20) for the TS-130V, frequency controller (DFC-230), external VFO (VFO-120), external speaker (SP-120), mobile mount (MB-100), CW filter (YK-88C), CW narrow filter (YK-88CN), SSB narrow filter (YK-88SN), and other optional units are available.

SECTION 2. PREPERATION FOR USE

2.1 ACCESSORIES

The following accessories are furnished with the TS-130S(V):

External speaker plug (E12-0001-05).....	1
7P DIN remote plug (E07-0751-05)	1
DC power cord (TS-130S) (E30-1638-05)	1
(TS-130V) (E30-1675-05).....	1
Fuse, 20A (TS-130S) (F05-2034-05).....	1
4A (TS-130V) (F05-4022-05)	1
4P MIC plug (E07-0403-05)	1
(Excluded in U.S.A.)	

2.2 INSTALLATION

It is preferable to choose an operating location that is dry and cool, and to avoid operating the transceiver in direct sunlight.

Allow adequate ventilation, particularly during mobile operation.

NOTE:

The TS-130S(V) is supplied to receive on the following frequencies (transmission is disabled):

- 10 MHz band (10.0—10.25 MHz)
- 18 MHz band (18.0—18.5 MHz)
- 24.5 MHz band (24.5—25.0 MHz)

2.3 INTERCONNECTION

Connect the transceiver as illustrated in Fig. 2-1, 2-2.

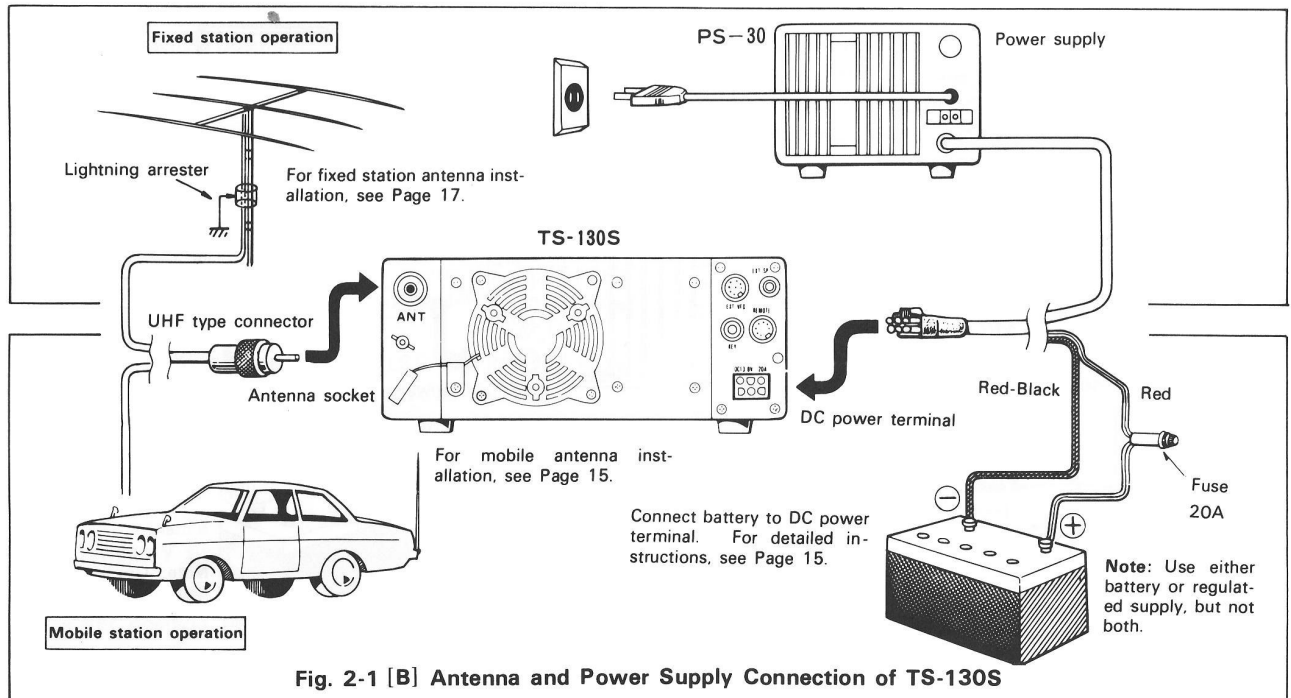
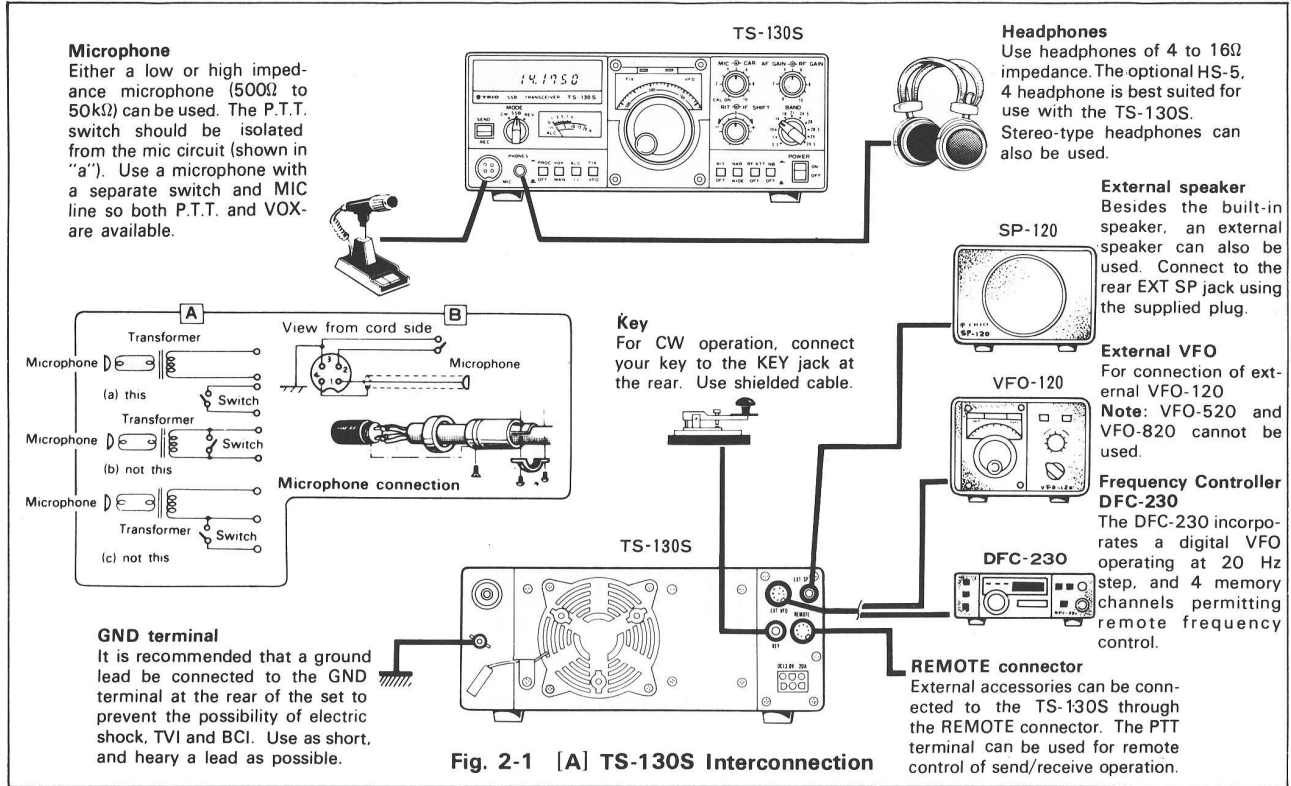

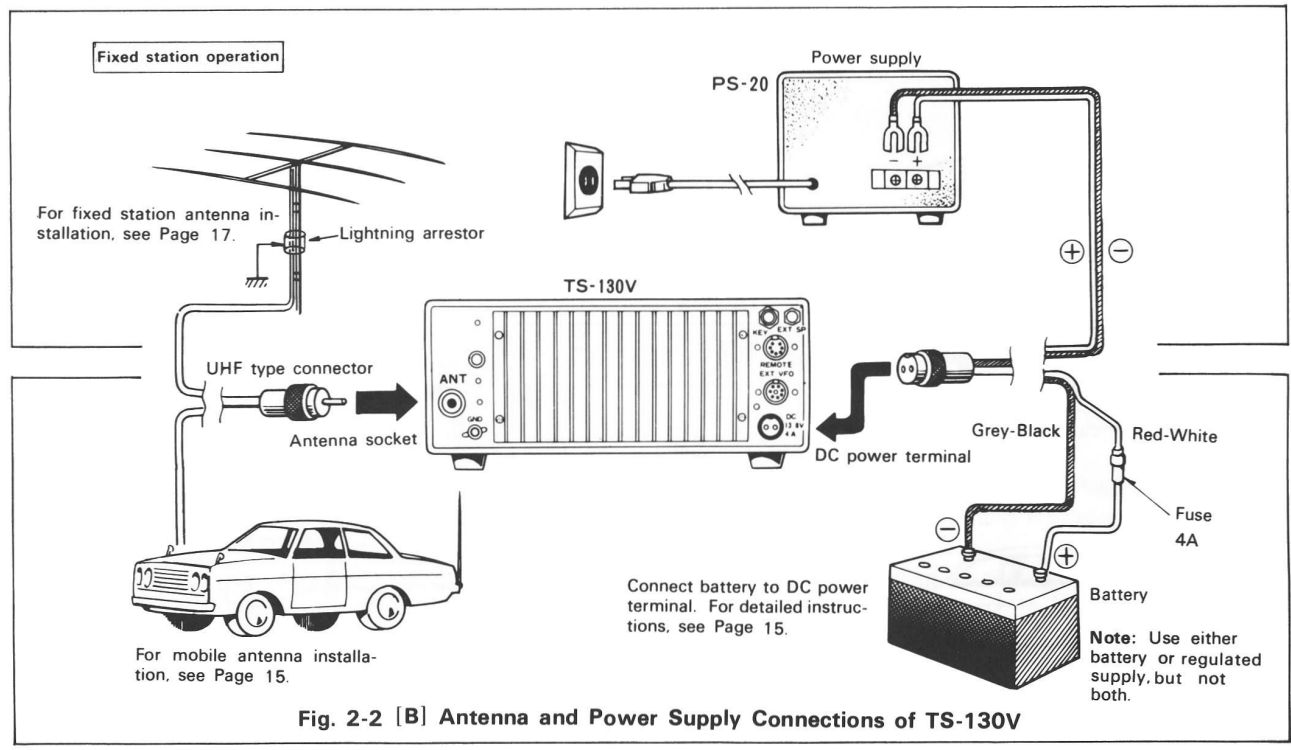
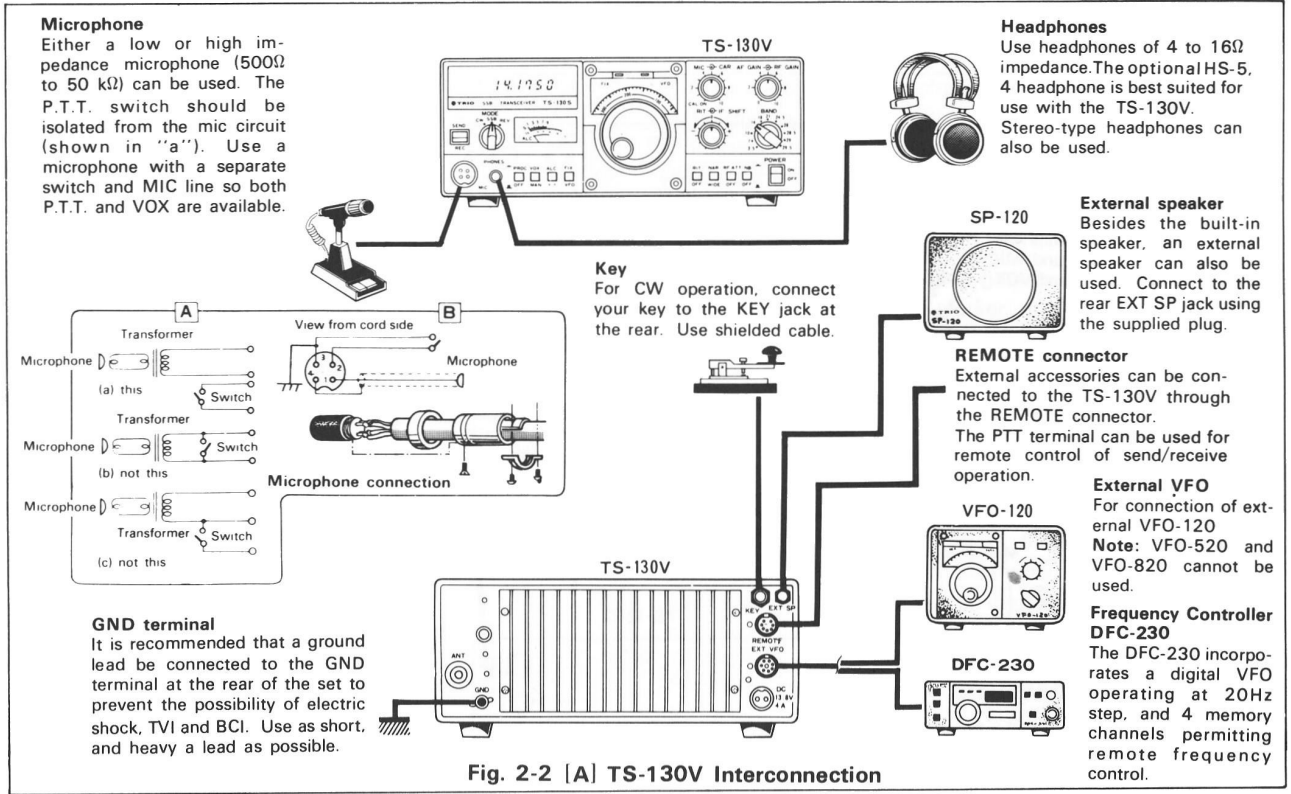

SECTION 3. CONTROLS

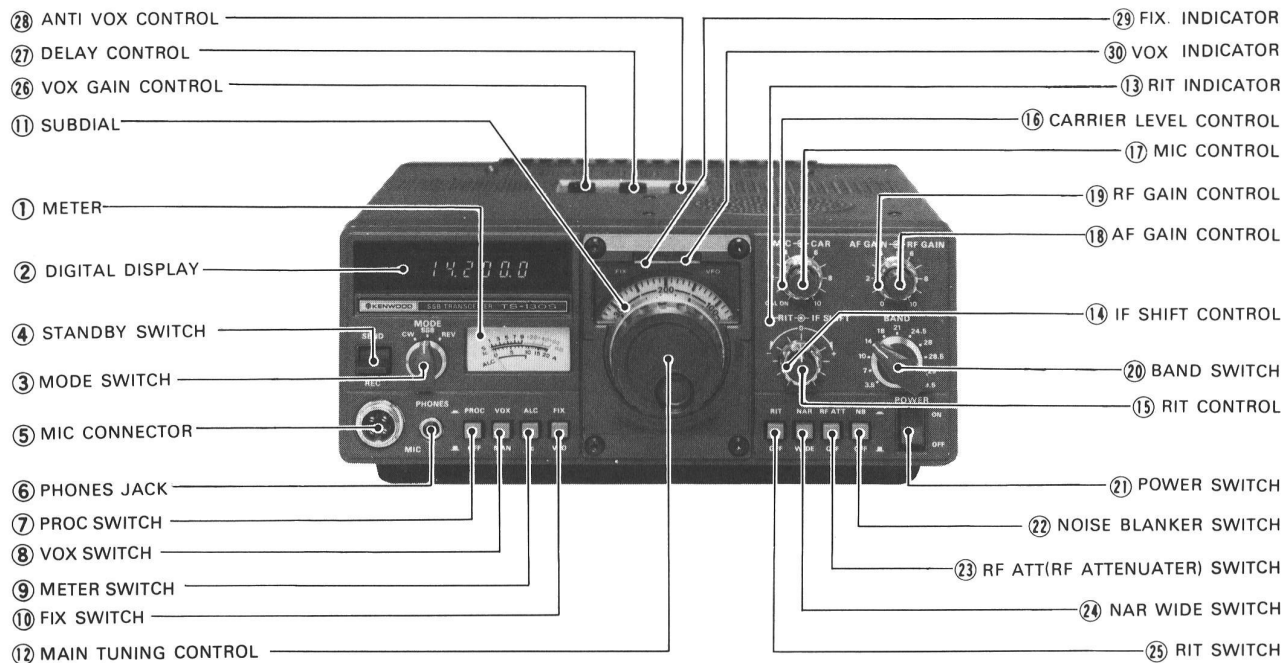

Fig. 3-1 Front Panel

3.1 FRONT PANEL

① METER

The meter has three functions, two being selected by the METER switch. In receive the meter is automatically an S-meter showing receive signal strength on a scale of 1 ~ 9, 9 + 20, + 40 and + 60 dB. In transmit, the meter shows Ic (TS-130S), RF output (TS-130V) or ALC level depending on METER switch position.

② DIGITAL DISPLAY

The digital display indicates true operating frequency to an accuracy of 100 Hz.

③ MODE SWITCH

SSB Permits SSB operation. LSB is normally selected for operation on the 3.5 and 7 MHz bands, and USB for operation on and above the 10 MHz bands.

Switching between LSB and USB is done automatically by the BAND switch.

REV During SSB operation, this position selects the reverse side band from USB to LSB or vice versa.

CW Used for CW operation.

④ STANDBY SWITCH

This switch selects receive or transmit function.

In the REC position, the transceiver is normally in the receive mode unless the microphone PTT switch is depressed. In the SEND position, the TS-130S(V) is switched to the transmit mode.

CAUTION: Do not transmit without an antenna or dummy load. Equipment damage will occur. Such damage is not covered by warranty.

⑤ MIC CONNECTOR

Connect your microphone (MC-30S, MC-35S, MC-50, etc.), referring to Fig. 2-1, 2-2. The TS-130S(V) accepts both low and high impedance microphones.

⑥ PHONES JACK

The headphone jack allows use of 4-to-16-ohm headphones. HS-5, HS-4 optional headphones provide optimum results. Stereo-type headphones can also be used. This will disable the internal and external speaker.

⑦ PROC (processor) switch

During SSB transmission, the speech processor may be used to increase "talk power".

⑧ VOX (VOICE OPERATED TRANSMIT) SWITCH

This function is used for SSB VOX or CW semi-break-in - operation. In the MAN (manual) position, the transceiver is keyed by either the standby switch or the microphone PTT switch. For VOX operation, the standby switch remains in REC. (See page 12.)

⑨ METER SWITCH

During transmission, the meter switch determines meter function. The switch selects between:

ALC The meter monitors the output of the final stage power amplifier during transmission. During SSB operation, adjust the MIC control so that the meter pointer is within the ALC zone. Similarly, adjust the CAR control for CW operation.

IC (TS-130S)... The meter monitors final stage collector current. 12 ~ 19A is normal, 17A typical.
RF (TS-130V)... In this position the meter monitors the relative RF output of the transceiver.

⑩ **FIX (fixed channel) SWITCH**

The TS-130S(V) has a built-in fixed channel oscillator (crystals are user-provided, optional) which is activated by the FIX switch for fixed channel or VFO operation.

⑪ **SUBDIAL**

The subdial is calibrated from 0 to 500. It is driven from the main tuning knob to indicate the transceiver's operating frequency.

⑫ **MAIN TUNING CONTROL**

This control is used to select the desired operating frequency. The scale on the control knob is calibrated at 1 kHz intervals, allowing accurate tuning. For exact frequency, read the Digital Display.

⑬ **RIT INDICATOR**

This light emitting diode indicates the RIT circuit is ON.

⑭ **IF SHIFT CONTROL**

By using this control, the IF crystal filter center frequency can be shifted ± 1 kHz, allowing adjustment of tone quality, or eliminating interference from adjacent frequencies. For normal operation, this control should be set to the center "0" position (detent).

⑮ **RIT CONTROL**

When the RIT circuit is ON, this will vary receive frequency by about ± 1.5 kHz. When the control is set to the "0" center position, there is no frequency shift.

⑯ **CAR (CARRIER LEVEL) CONTROL**

This control is used to adjust the carrier output level and is effective only during CW operation. Adjust the control so the ALC meter indication is within the ALC zone. For "QRP" operation, reduce carrier injection.

⑰ **MIC (MICROPHONE GAIN) CONTROL**

This adjusts mic amplifier gain during SSB operation. Again, adjust the control so the ALC meter indication is within the ALC zone.

When this control is set to the CAL ON position, the built-in calibrator is activated, permitting calibration of the receiver dial scale at 25 kHz intervals.

⑱ **AF GAIN (AUDIO GAIN) CONTROL**

This control adjusts the receiver audio amplifier gain. Volume of the received signal increases as the control is turned clockwise.

⑲ **RF GAIN CONTROL**

This adjusts the receiver section's RF amplifier gain. Turn the control fully clockwise for maximum gain. Turn counterclockwise to reduce the gain.

⑳ **BAND SWITCH**

This switch selects all entire Amateur bands from 3.5 — 29.7 MHz. The 10, 18, and 24.5 MHz bands as supplied are for reception only, and transmission on these frequencies is not possible. Use the 10 MHz band to receive WWV at 10.0 MHz.

CAUTION:

Do not turn the bandswitch during transmit.

㉑ **POWER SWITCH**

This switches the TS-130S(V) ON and OFF.

㉒ **NB (NOISE BLANKER) SWITCH**

This switch is used to reduce pulsating ignition noises of the type usually emitted from motor vehicles. Power-line, QRM and atmospheric "white" noise will not operate the noise blanker.

㉓ **RF ATT (ATTENUATER) SWITCH**

With this switch ON, A 20 dB attenuator is inserted in the antenna circuit, protecting the RF amplifier and mixer from overload on strong input signals.

㉔ **NAR/WIDE switch**

This switch selects receive IF bandwidths between narrow and wide. The WIDE position provides the same IF bandwidth for both CW and SSB. For the NARROW position, optional filters are available for both CW and SSB.

㉕ **RIT SWITCH**

This push switch turns the RIT (Receiver Incremental Tuning) circuit ON and OFF. With the switch depressed, the circuit is activated and the RIT indicator is illuminated, allowing the receive frequency to be shifted by about ± 1.5 kHz independent of the transmit frequency by using the RIT control. The RIT circuit is turned OFF when the switch is out.

㉖ **VOX GAIN CONTROL**

This control adjusts VOX circuit sensitivity for both SSB and CW operation.

㉗ **DELAY CONTROL**

This control is used to adjust the "Hold" time of the VOX circuit. Clockwise adjustment gives longer hold-time.

㉘ **ANTI-VOX CONTROL**

This control is used to adjust the VOX system so that it is not tripped by sound from the speaker.

㉙ **FIX INDICATOR**

The FIX indicator illuminates when the internal fixed frequency oscillator controls transceiver operation.

㉚ **VFO INDICATOR**

The VFO indicator illuminates when the internal VFO controls transceiver operation. The indicator is not lighted during fixed channel or remote VFO operation.

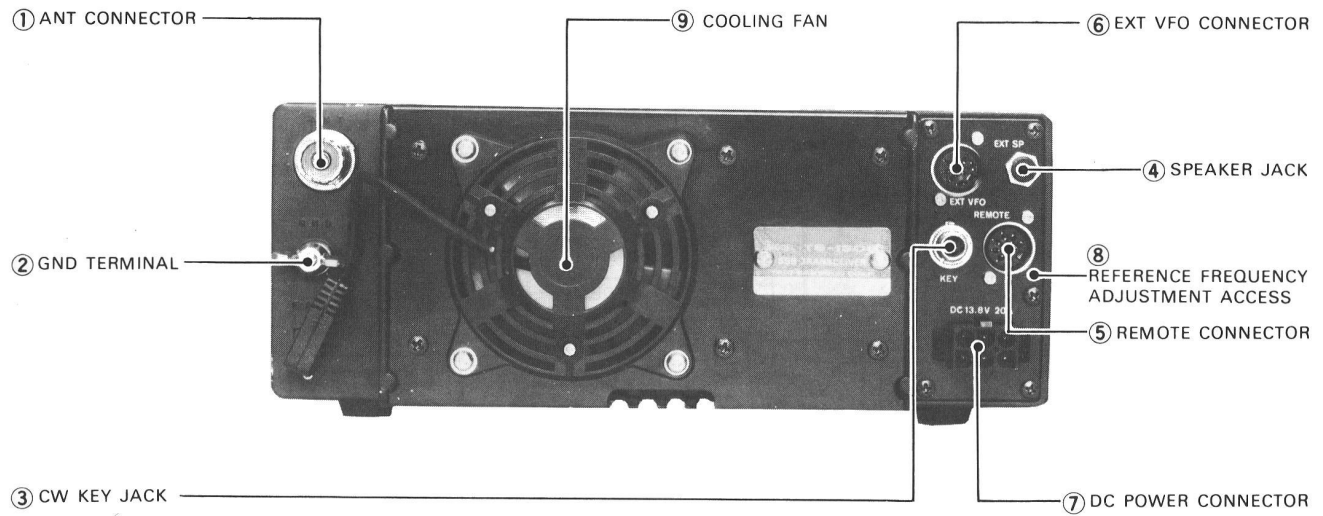

Fig 3-2 Rear, Top Panel

3.2 REAR PANEL

① ANT (ANTENNA) CONNECTOR

This UHF connector should be attached to a suitable antenna for transmitting and receiving. The antenna cable should be 50-ohm coax, terminated with a PL-259 connector.

② GND (GROUND) TERMINAL

The TS-130S(V) should be grounded through this terminal to avoid the possibility of TVI and BCI. Use as short and heavy a lead as possible.

③ CW KEY JACK

For CW operation, connect your key to this terminal using a two conductor phone plug and shielded cable.

④ SPEAKER (EXTERNAL SPEAKER) JACK

An external speaker of 4 ~ 16 ohms impedance (such as the SP-120) can be connected here. This will disable the internal speaker.

⑤ REMOTE CONNECTOR

This is used for interconnecting a linear amplifier or other equipment. For connection, refer to the illustration below, fig. 3-3.

⑥ EXT VFO (EXTERNAL VFO) CONNECTOR

This is for connection of an external VFO-120, remote Frequency Controller DFC-230. (Note: the VFO-520 and VFO-820 cannot be used, since their operating frequency is incorrect.)

⑦ DC POWER CONNECTOR

This is used to connect the DC power supply.

⑧ REFERENCE FREQUENCY ADJUSTMENT

For PLL reference oscillator adjustment. Use WWV signal for calibration.

⑨ COOLING FAN

The cooling fan operates when the heat-sink temperature rises.

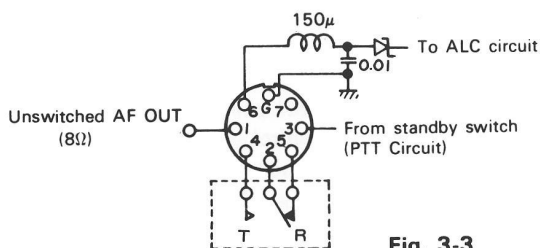

Fig. 3-3

INTERNAL WIRING IN THE TS-130S(V)

SECTION 4. OPERATION

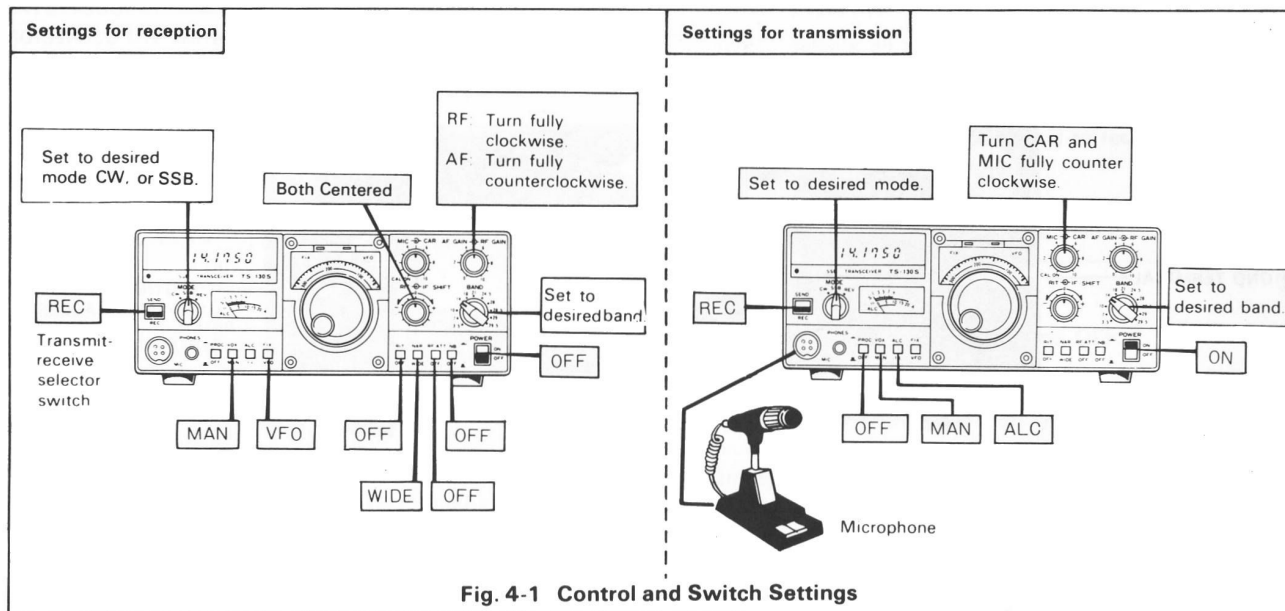

Fig. 4-1 Control and Switch Settings

4.1 RECEPTION

First connect the antenna, microphone and key. Then, set the controls and switches referring to Fig. 4-1.

Ascertain that the TS-130S(V) is ready for operation, then turn the POWER switch ON. The meter, dial scale and digital display will illuminate, indicating the transceiver is in operation. The transceiver is fully solid-state, allowing reception as soon as the POWER switch is turned ON.

Advance the AF GAIN control clockwise until some receiver noise is heard from the speaker. Turn the main tuning control so the desired signal can be heard clearly.

4.1.1. WWV RECEPTION

To receive WWV at 10 MHz, set the BAND switch to "10" and turn the main tuning control until the subdial reads "0".

4.1.2 RF ATT switch

The input to the receive RF amplifier is attenuated approximately 20 dB, providing distortion-free reception. This feature may be used in cases of receiver overload, caused either by a strong local signal, or during weak signal reception when a strong adjacent signal may blank the receiver.

4.1.2. NB SWITCH

The TS-130S(V) has a sophisticated noise blanker designed to reduce ignition-type pulse noise. The noise blanker is particularly important for mobile operation. When necessary, activate the noise-blanker by depressing the NB switch ON.

4.1.3. RF GAIN CONTROL (Fig. 4-2)

For normal operation, this control should be turned fully clockwise for maximum sensitivity. Receive sensitivity is reduced by turning the control counterclockwise.

Adjust the RF GAIN so the S-meter does not show excessive deflection. This minimizes noise during reception and allows the S-meter to indicate signal peak (or a little below that point). Noise is markedly reduced when the signal is absent.

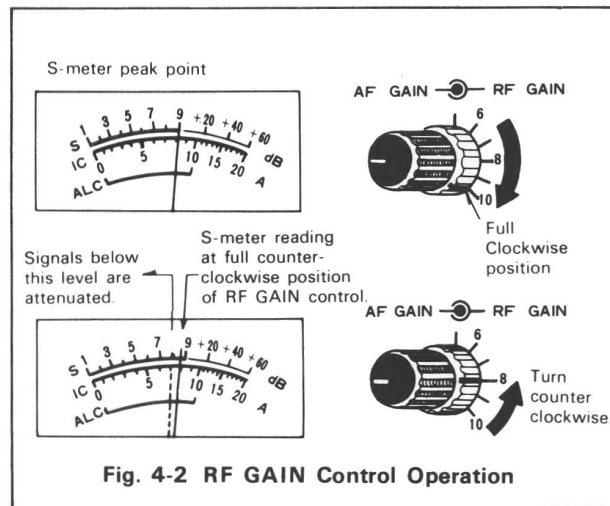

Fig. 4-2 RF GAIN Control Operation

4.1.4. RIT CONTROL

By using the RIT (Receiver Incremental Tuning) control, the receive frequency can be shifted by about ± 1.5 kHz without changing the transmit frequency.

If the frequency of the station you are working changes, your receive frequency can be reset by turning the RIT switch ON and adjusting the RIT control. Adjusting the control clockwise increases the frequency. The RIT shift can be checked by the digital display. When first calling another station, the RIT should be OFF, otherwise your transmit and receive frequency will not coincide.

4.1.5. IF SHIFT CONTROL

The IF SHIFT control is used to shift the passband of the IF filter without changing receive frequency. By turning this control in either direction, the IF passband is shifted as shown in Fig. 4-3.

The IF SHIFT is effective in eliminating interference when the receive signal is superimposed on nearby signals during operation in both SSB or CW mode.

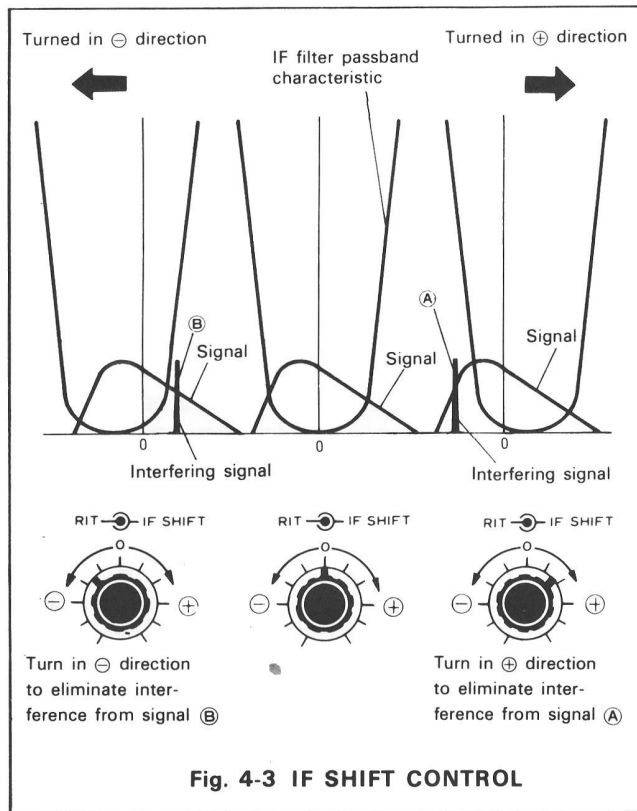

Fig. 4-3 IF SHIFT CONTROL

(1) USB Mode (10 MHz and above)

Adjust the IF SHIFT control in the ⊕ direction and lower frequencies are cut. Adjust the control in the ⊖ direction and high frequencies are cut.

(2) LSB Mode (3.5, 7 MHz)

Adjust the control in the ⊕ direction and higher frequencies are cut. Adjust the control in the ⊖ direction and low frequencies are cut.

(3) CW Mode

By using the IF SHIFT in conjunction with the RIT, tone quality can be adjusted.

4.1.7 NAR-WIDE switch operation

For short to medium distance communication, the WIDE position may be used for both SSB and CW operation. For DX (long distance) communication, the NAR position will be an advantage in reducing interference.

This feature, in combination with the IF SHIFT control, will provide outstanding interference rejection. The receive IF

bandwidth is 2.4 kHz in the wide position, and 270 or 500Hz for CW (with optional filters YK-88CN and YK-88C respectively) and 1.8 kHz for SSB (with optional filter YK-88SN), both in the NAR position. In transmit, bandwidth is automatically WIDE.

PASSBAND WIDTH (−6dB) kHz

FILTER	MODE		SSB	
	WIDE	NARROW	WIDE	NARROW
No optional filter	2.4	*	2.4	*
YK-88C or CN	2.4	500 or 270	2.4	*
YK-88SN	2.4	1.8	2.4	1.8
YK-88C or CN YK-88SN	2.4	500 or 270	2.4	1.8

* Can not be received.

4.2 TRANSMISSION (Fig. 4-4)

CAUTION:

Before transmitting, be sure to connect an antenna or dummy load with a VSWR of less than 1.5:1. Never attempt to transmit with the antenna terminal left open.

When testing the transmitter, connect a 50-ohm dummy load, rated at more than 100W (TS-130S), or 10W (TS-130V). Refer to Fig. 4-1 for initial control settings. When the TS-130S(V) is ready for transmission, use the following procedure:

● SSB Operation

- 1 Set the MODE switch to SSB.
- 2 Meter switch to ALC.
- 3 Standby switch to SEND.
- 4 Speak into the microphone and adjust the MIC GAIN for meter deflection within the ALC zone at signal peaks.

● PROC (processor) operation

In DX (long distance) operation, it may be desirable to increase talk-power by using the speech processor.

The speech processor in the TS-130S(V) Series combines an audio compression amplifier with changes in ALC time constant to provide extra audio punch and to increase average SSB output power, while suppressing sideband splatter.

To activate, turn on the PROC switch, and readjust mic gain operated as described, distortion will be minimal, however, tone quality will be affected, it is therefore advisable to conduct normal operation with the processor disabled.

NOTE:

When a high-output microphone is used, input overload and distortion will result.

To prevent this, use an attenuator in the microphone circuit as shown below, or connect a 10 — 33kΩ resistor (depending on microphone used) across the microphone input. (Mic control setting should be approximately 12 O'clock)

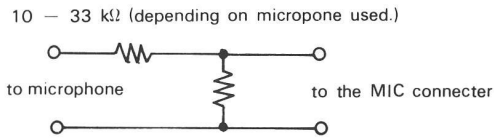

The MC-50 microphone is recommended (Microphone sensitivity: $-55 \pm 3\text{dB}$ when for approx. 5 cm distance to the mic.)

● **CW Operation**

- 1 Set the MODE switch to CW and the meter switch to ALC.
- 2 Set the standby switch to SEND and adjust the CAR control so the meter deflects within the ALC zone. If a key is connected, it should be depressed during the adjustment.

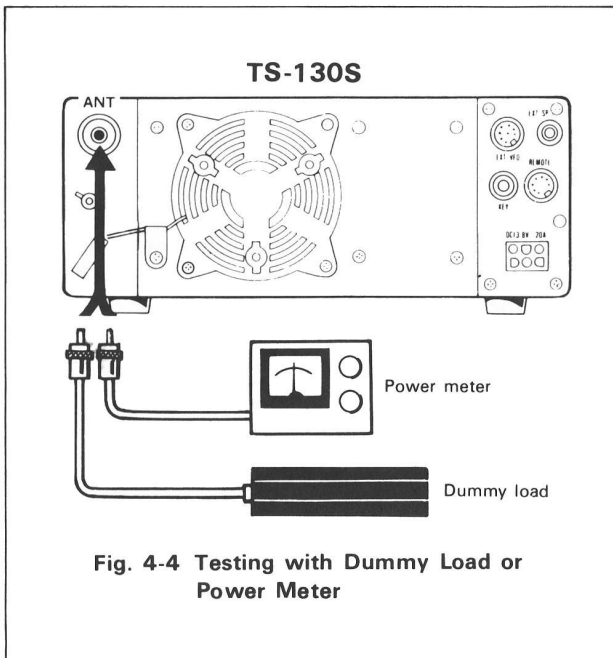

4.2.1. FINAL STAGE PROTECTION

The TS-130S(V) features a VSWR protection circuit to protect the final-amplifier transistors. The circuit in the TS-130V is different than the circuit in the TS-130S.

(1) TS-130V

If the VSWR increases because of improper antenna impedance, the protection circuit activates to prevent the final-stage transistors from being overloaded. In this case, transmitter output power is reduced.

(2) TS-130S

Three different protection circuits are designed into the TS-130S.

- i) The same VSWR protection method as used in the TS-130V is used in the TS-130S. That is, the final-stage transistors are protected by detecting VSWR of the antenna system and automatically lowering transmitter output power if the VSWR is too high.

this cooling fan sufficiently cools off the heat sink radiator.

- ii) When the heat-sink temperature rises, a detection circuit activates a cooling fan. Under normal conditions,
- iii) The heat-sink temperature could rise abnormally during long transmissions, if the area adjacent to the heat-sink is blocked. In this case, the TS-130S automatically returns to the receiving mode, and transmitting is not possible until the heat-sink cools to the proper temperature.

NOTES:

1. If transmitter output decreases due to activation of the protection circuit caused by high VSWR, recheck and retune the antenna system carefully.
2. When the cooling fan starts to turn, determine that adequate air flow is possible in the heat-sink area.

(3) Operation of the Cooling Fan

The cooling fan operates when the heat-sink temperature rises, to approximately 50°C (122°F) and it ceases to operate when the temperature decreases to normal, approximately 40°C (104°F). The heat-sink is made of die-cast aluminum and is actually the rear panel. It must be kept clear of surrounding objects, in order that heat will dissipate easily.

The cooling fan is designed to operate when the heat-sink temperature is at a specific level, regardless of whether the unit is in transmit or receive mode.

Fan life is approximately 500 hours.

4.2.2. MIC GAIN CONTROL (Fig. 4-5)

This control adjusts the microphone input level. When using the TS-130S(V) in SSB mode, connect a microphone and set the standby switch to SEND (antenna or dummy load MUST be connected).

Set the meter switch to ALC and speak into the microphone. Adjust the MIC GAIN control so the meter does not deflect out of the ALC zone at signal peaks.

The TS-130S(V) accepts either a low or high impedance microphone (500 Ω to 50 k Ω). When using a low impedance microphone (500 Ω) the MIC GAIN control should be advanced higher than when a high impedance microphone is used, while observing the ALC meter.

● **ALC (Automatic Level Control)**

The ALC monitors the transmitter final stage output to minimize distortion in your transmitted signal. It automatically adjusts output to an optimum level.

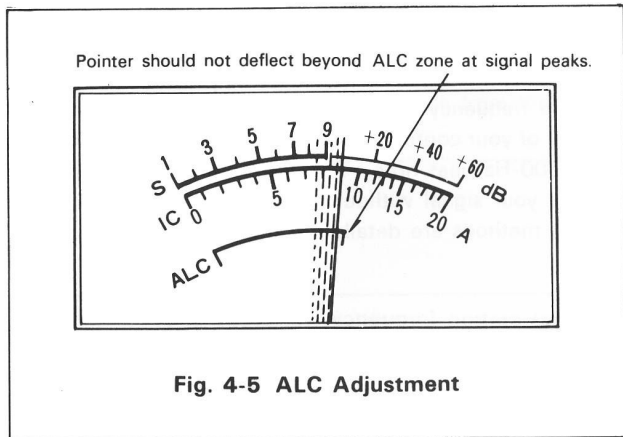

4.3 VOX OPERATION

4.3.1. VOX SWITCH

VOX (voice operated transmit) is used to switch the TS-130S(V) into transmit mode by your voice. Depress the switch ON and speak into the microphone. The transceiver automatically switches to transmit mode (the MIC control should be adjusted in advance as explained in Item 4.2.2). Both the send switch and the MIC P.T.T. switch are left in the REC position.

4.3.2. VOX GAIN CONTROL

This adjusts the VOX circuit sensitivity. Speak into the microphone at normal voice levels and adjust the control. Clockwise increases sensitivity, allowing transmission with a low voice level. Transceiver operating condition can be checked by the sound from the speaker. When the speaker is silent, the transceiver is in transmit mode.

Note that if the control is advanced too far, the VOX circuit is "tripped" by ambient noise.

4.3.3. ANTI-VOX CONTROL

This prevents the VOX circuit from being "tripped" by sound from the speaker.

Adjust the control so the VOX will not operate at the desired speaker volume level.

4.3.4. VOX DELAY CONTROL

This control adjusts the transmit hold time of the VOX circuit. If the hold time is too short, the transceiver will return to receive mode as soon as you stop talking into the microphone. This can be eliminated by turning the control clockwise. Adjust the control for comfortable operation at a normal rate of speech.

4.4 SEMI-BREAK-IN OPERATION

The TS-130S(V) has a built-in side-tone oscillator to permit semi-break-in operation, besides the normal CW operation. During semi-break-in operation, the transceiver is placed in transmit mode when the key is depressed, and returns to receive mode when the key is released. The VOX circuit is activated by the side-tone.

For semi-break-in operation, set the VOX switch ON and the MODE switch to CW. Adjust the VOX GAIN to insure that the transceiver is set in transmit mode whenever the key is depressed. Also, adjust the VOX DELAY for desired hold-in. ANTI VOX adjustment is not required.

4.5 OPERATION WITH A LINEAR AMPLIFIER

The ACSY connector on the rear panel provides for inter-connection with an amplifier. See the amplifier instruction manual to determine whether the linear requires a normally opened or normally closed (during receive) relay contact.

Connect the amplifier control line to either pin 5 (N.C.) or pin 4 (N.O. during receive). Connect the Ground (Shield) of the Control Line to Pin 2 and Pin 7. Connect amplifier ALC to pin 6 of the ACSY connector. The TS-130S output is quite adequate to drive most amplifiers to full rated output.

4.6 FIXED CHANNEL OPERATION (Fig. 4-6)

The TS-130S(V) has a built-in crystal-controlled oscillator for fixed-channel operation. This feature is most useful for commonly used frequencies, nets, or any situation where crystal-controlled operation is required.

The TS-130S(V) accepts a maximum of four crystals one each for the 7, 14, 21 and 28 MHz bands. The 14 MHz position can also be used as 10 MHz and 18 MHz position. The 28 MHz position can be used as 24.5 MHz position.

Since the 28 MHz band position can be used for the 24.5, 28.0, 28.5, 29.0, and 29.5 MHz bands, channel frequencies of 24.6, 28.1, 28.6, 29.1, and 29.6 MHz are obtained when a crystal of 28.6 MHz is used.

For operation in the 3.5 MHz band, change the position of the connector from the 28 MHz to the 3.5 MHz position as shown in Fig. 4-6

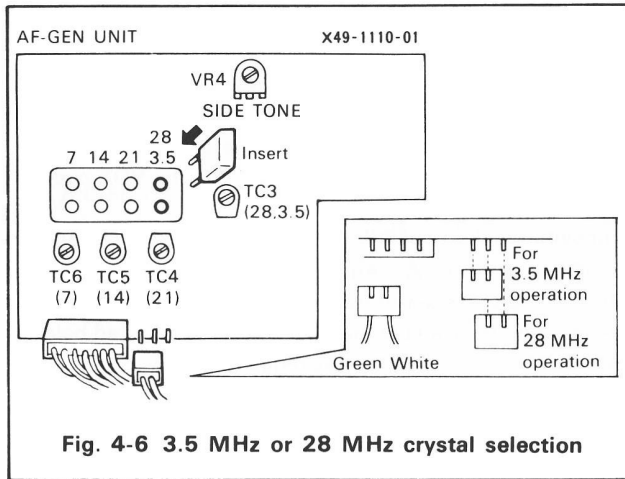

Fig. 4-6 3.5 MHz or 28 MHz crystal selection

The crystal frequency is determined by the following formula:

$$\text{Crystal frequency (MHz)} = 5.5 - X + \text{Operating frequency (MHz)}$$

- X = 3.5 (80m band)
- X = 7.0 (40m band)
- X = 10.0 (30m band)
- X = 14.0 (20m band)
- X = 18.0 (17m band)
- X = 21.0 (15m band)
- X = 24.5 (12m band)
- X = 28.0 (10m band)
- X = 28.5 (10m band)
- X = 29.0 (10m band)
- X = 29.5 (10m band)

Crystal Specifications:

- Type of crystal holder: HC-25/U
- Oscillation frequency: 5.5 ~ 6.0 MHz
- Multiplication: Fundamental
- Frequency tolerance: ±0.002% at normal temperature
- Oscillation circuit: See Fig. 4-7

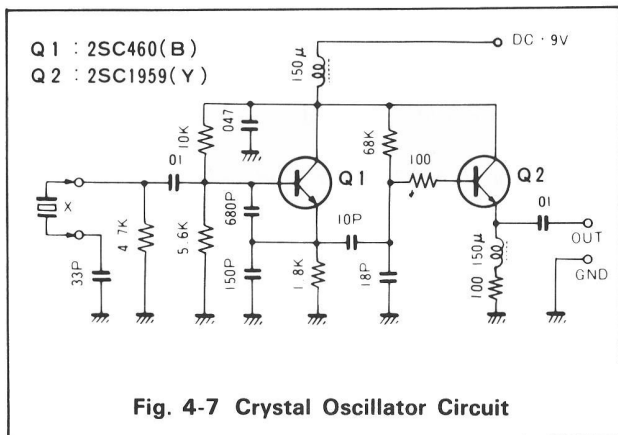

Fig. 4-7 Crystal Oscillator Circuit

4.7 CW OPERATION (Fig. 4-8)

For CW operation, your transmit frequency should be "zeroed" to the transmit frequency of your contact station. Receive frequency is 800 Hz lower than the transmit frequency of your contact station, so that his signal is received as a 800-Hz beat note. This also allows your contact to receive your signal without having to retune receiver. Tuning methods are detailed in the following paragraphs.

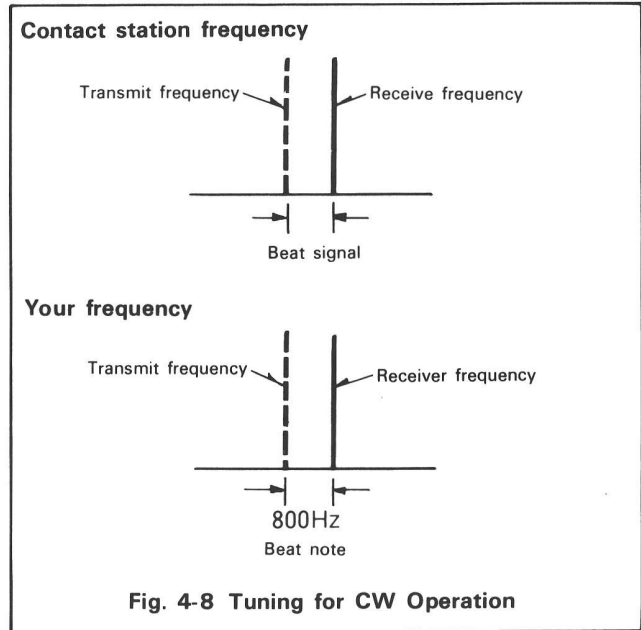

Fig. 4-8 Tuning for CW Operation

4.7.1. OPERATION WITHOUT OPTIONAL CW FILTER

Set the IF SHIFT control to its center position and the RIT switch OFF. Adjust the main tuning control for an 800-Hz beat note and your transmit frequency will then coincide with that of your contact station ("zeroed"). During reception, the side-tone monitor is activated by pressing down the key (VOX OFF). In this case, listen to the side-tone superimposed on the receive signal and adjust the main tuning for similar side-tone and incoming CW audio tone. By so doing, transmit frequencies will be zeroed.

You may now adjust the RIT for a pitch which suits your preference. If interference is encountered, adjust the IF SHIFT. For more convenient and effective CW operation, use of the optional YK-88C or YK-88CN CW crystal filter is recommended.

4.7.2. OPERATION WITH CW FILTER (YK-88C)

Set the IF SHIFT to its center position and the RIT to OFF. Adjust the main tuning control for maximum deflection of the S-meter. Receive signal pitch will be about 800 Hz, indicating correct tuning.

4.7.3. KEY CONNECTION (Fig. 4-9)

Your key should be connected as illustrated in Fig. 4-9. When using an electronic keyer, make sure that polarity is set for positive. Always use shielded line from the key to transceiver.

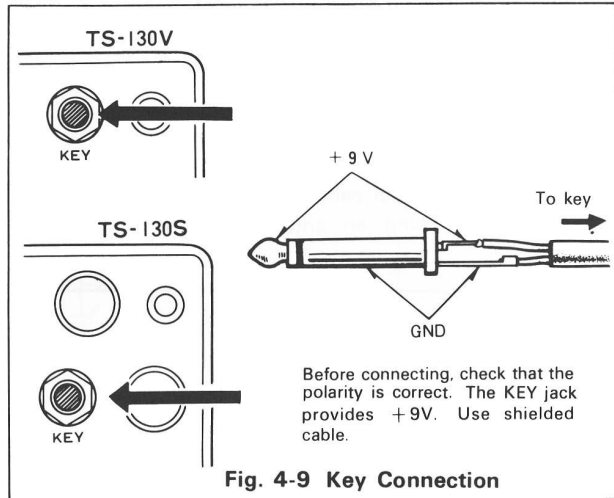

Fig. 4-9 Key Connection

4.8 MOBILE OPERATION (Fig. 4-10)

The TS-130S(V) being compact in design, is ideal for mobile operation. Satisfactory mobile operation is achieved through proper power and antenna connection, and thoughtful transceiver installation and adjustment.

4.8.1. TS-130S(V) INSTALLATION

Secure the TS-130S(V) under the dashboard using an optional MB-100 mounting bracket as shown in Fig. 4-10. As an alternative, use strapping, making sure that the TS-130S(V) will not slip out of place while driving the vehicle.

NOTES:

1. Do not install the TS-130S(V) near the heater outlet.
2. Allow sufficient space behind the TS-130S(V) to ensure proper ventilation.

4.8.2. HOW TO HANDLE THE POWER CABLE

When connecting or disconnecting the power cable to or from the power connector, be sure that the power switch is always in the "OFF" position. Observe polarity of the cable. The TS-130S(V) operates on 13.8 VDC, negative ground. Battery polarity must be correct. The power cord is color coded:

CAUTION: Observe battery polarity.

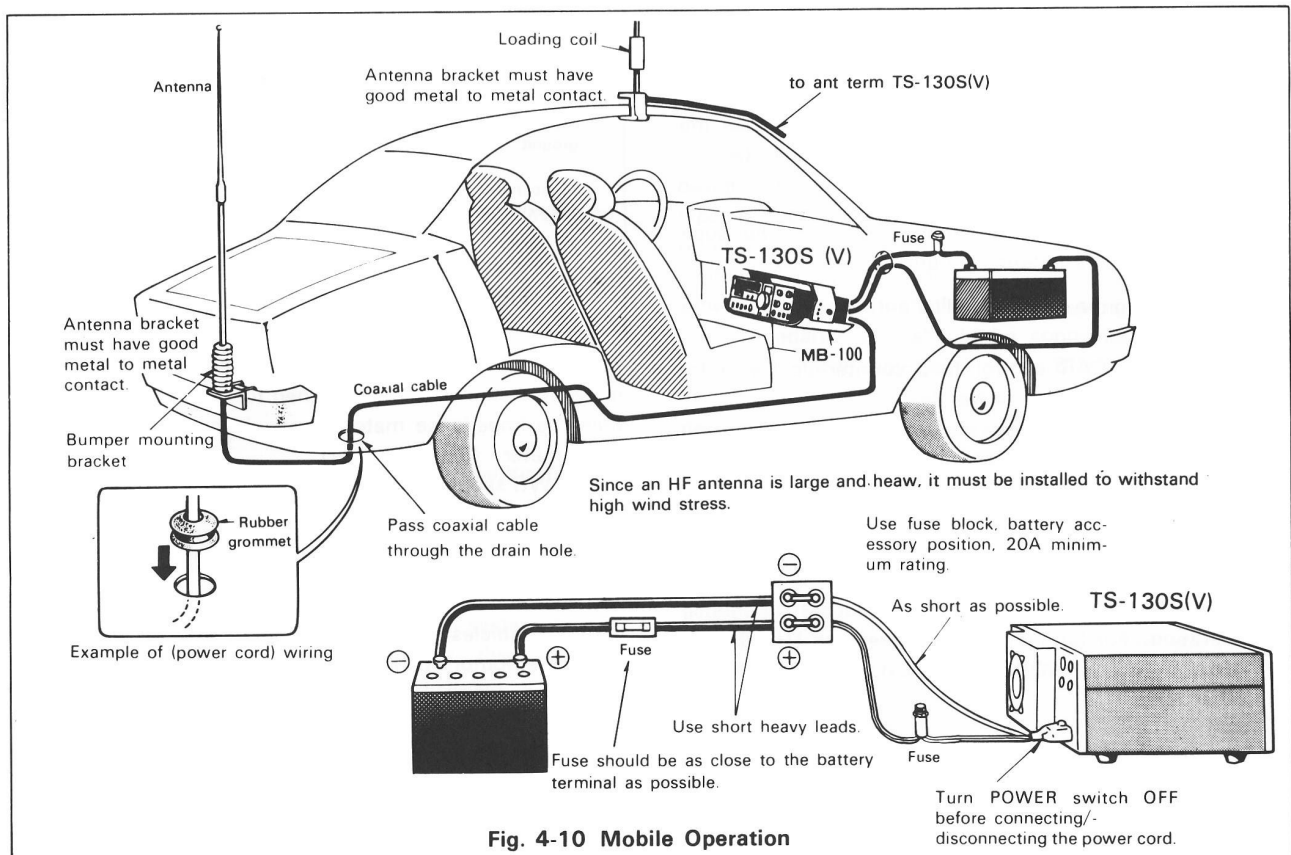

Fig. 4-10 Mobile Operation

POWER CABLE

TS-130V	TS-130S
red ⊕ red or black ⊖	red and white ⊕ black and gray ⊖

Connect the TS130S(V) power cable to the battery terminals, with consideration to current requirements and noise prevention. The maximum current drawn by the TS-130S reaches to between 18 and 20A when transmitting. Therefore, the cable should be made as short as possible, using the specified fuse. Also, determine that the power system of the car (including the battery and generator or alternator) will handle the increased load of the TS-130S(V).

Route battery and ANTENNA leads away from all high voltage secondary circuits to prevent ignition noise interference.

4.8.3. MOBILE ANTENNA

(1) Antenna Installation

Use a rugged mount for the mobile antenna because HF antennas are larger (and have more wind load) and are heavier than VHF antennas. A bumper mount is recommended for general use. The ground side of the mount must be grounded perfectly to the body of the car since the body itself functions as the ground plane for the mobile antenna. (Refer to Fig. 4-10.)

NOTES:

- Some cars have a urethane plastic bumper. For such cars, ground the antenna mount to the body.
- When tuning the newly installed antenna, use following procedure:
 - Turn the CAR control fully counter-clockwise for minimum transmit power.
 - With the transceiver in transmit mode, raise transmit power output slowly by rotating the CAR control clockwise. The antenna should be adjusted with minimum power.
 - Transmitting with full power is recommended after the antenna is adjusted for a VSWR below 1.5:1.
- Antenna installation is critical for successful mobile operation. For further information refer to THE RADIO AMATEUR'S HANDBOOK, RADIO HANDBOOK, or other texts.

(2) Coaxial Cable Connection (Fig. 4-10)

When the antenna is mounted on the vehicles bumper, the coaxial cable from the antenna can be routed through a drain hole in the trunk. When the antenna is roof mounted, pass the cable between the body and door. Leave a drip-loop at the lowest point in the cable before entry into the vehicle to prevent water from entering the car.

(3) Antenna Adjustment (Fig. 4-11)

Some mobile antennas are not designed for 50-ohm impedance. In this case, impedance matching between the antenna and the coaxial cable (50Ω) is required. This can be achieved by using an antenna matching device or coupler.

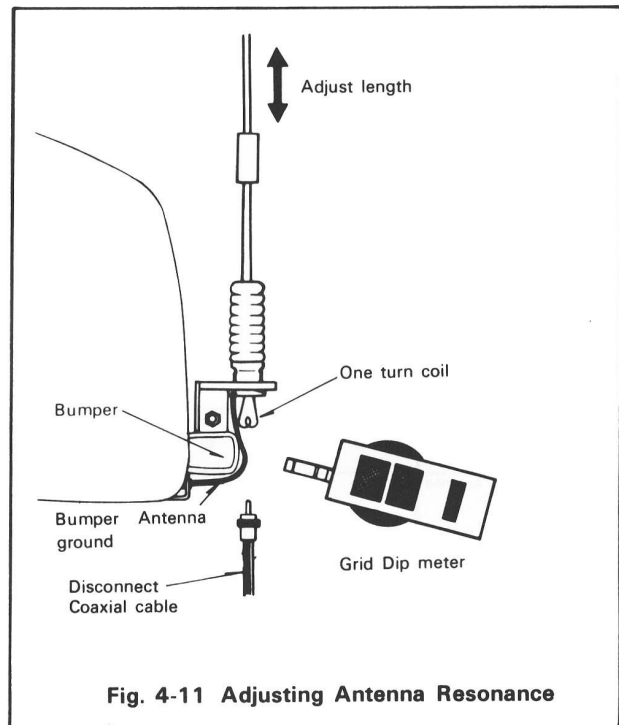

Fig. 4-11 Adjusting Antenna Resonance

The antenna to be used should first be checked with a dip meter to insure that it is designed for your operating band, then the impedance matching should be checked with an SWR meter. (See Fig. 4-11)

The VSWR should preferably be less than 1.5:1 for satisfactory operation. For antenna adjustment refer to the antenna instruction manual.

4.8.4. NOISE REDUCTION

In motor vehicles, ignition noise is generated by the ignition coil or distributor. Other sources of noise include the wiper and heater motor.

Although the TS-130S(V) is equipped with a noise blanker to minimize ignition noise, it is imperative that some preventive measures be taken to reduce the noise to the lowest possible level.

(1) Antenna Location Selection

Since ignition noise is generated by the vehicles engine, the antenna must be installed as far from the engine as possible.

(2) Antenna Matching

In general, mobile antennas have a lower impedance than 50-ohm coaxial cable, resulting in a mismatch between the antenna and the coax. Such trouble can be eliminated by using an antenna tuner between the TS-130S(V) and the coaxial cable.

- Matching Circuit Examples

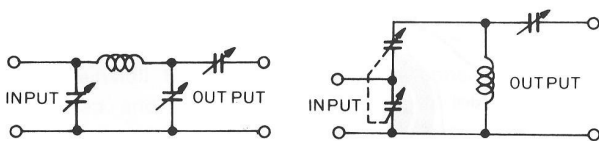

Fig. 4-12 Matching Circuits

(3) Bonding

The component parts of motor vehicles, such as the engine, transmission, muffler system, accelerator, etc., are coupled to one another at DC and low frequencies, but are isolated at high frequencies. By connecting these parts using heavy, braided ground straps, ignition noise can be reduced. This connection is called "bonding".

(4) Use Ignition Suppressor Cable or Suppressor Spark Plugs

Noise can be reduced by using spark plugs with internal resistors, or resistive suppressor ignition cable.

(5) Battery Power Connection

It is recommended that battery power be supplied directly to the TS-130S(V) from the battery terminals.

CAUTION:

Disconnect the TS-130S(V) before jump-starting or before charging the battery.

(6) Battery Capacity

The power system of a motor vehicle is comprised of a battery and an alternator (which generates power while the engine is running) to supply current to loads or to charge the battery.

Since the transceiver draws high current during transmit, care should be exercised so the power system is not overloaded. When using the transceiver, the following points should be observed from the viewpoint of battery maintenance:

- ① Turn the transceiver OFF when the lights, heater, wipers and other high-draw accessories are used.
- ② Avoid transceiver operation when the engine is not running.

- ③ If necessary, use an ammeter and/or a voltmeter to check battery condition.

4.9 FIXED STATION OPERATION

4.9.1. Power

The TS-130V power requirement is 4A at 13.8 VDC when transmitting with full power. The model PS-20 power supply for fixed stations matches the TS-130V in design and performance.

The TS-130S requires more than 18A at 13.8 VDC when transmitting with full power. Use the model PS-30 power supply for fixed stations.

4.9.2. ANTENNA

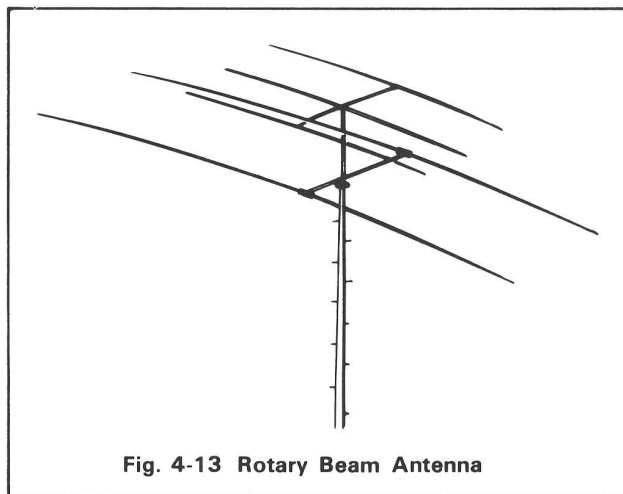

Fig. 4-13 Rotary Beam Antenna

For HF fixed-station operation, an antenna specifically designed for amateur operation is recommended. Antenna types include the wire antennas, verticals, rotary beam, and other antennas. HF antennas are quite large and must be installed to withstand strong wind, heavy rain, etc.

Any antenna used with the TS-130S(V) should be of 50-ohm impedance and should be connected using an appropriate coaxial cable such as RG-8/U.

Impedance matching is important. Impedance mismatching will result in a high VSWR and power loss, or can cause unwanted harmonic radiation and interference (TVI, BCI).

The impedance match can be checked with an SWR meter. Generally satisfactory operation is assured when the VSWR (Voltage Standing Wave Ratio) is less than 1.5:1.

For impedance matching between the antenna system and transceiver, use of the AT-130 Antenna Tuner (option) is recommended. A rotary beam antenna is very effective for DX operation in the 14, 21 and 28 MHz bands. (Fig. 4-13)

NOTE:

Protect your equipment — use a lightning arrester.

4.10 DIGITAL DISPLAY CALIBRATION (Fig. 4-14)

Connect the antenna and set the BAND switch to 10. Turn the main tuning dial to about "0" to receive the 10 MHz WWV signal. Adjust the dial until a low-frequency beat is heard. Next, depress the CAL switch and a marker signal is superimposed on the WWV beat signal. A double beat (two beat signals of high and low frequencies) will now be heard.

While receiving this double beat, adjust the Counter unit trimmer through the reference frequency adjustment access opening (at the side of the TS-130S(V) so the two beats are heard as a single beat. This completes calibration of the Digital Display. After calibration depress and release the CAL switch.

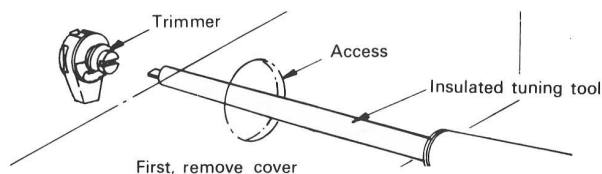

Fig. 4-14 Digital Display Calibration

4.11 ANALOG DIAL CALIBRATION (Fig. 4-15)

The main dial scale is graduated at 1-kHz intervals. One revolution of the main dial covers 25 kHz. To calibrate the scale, turn the CAL switch ON AND IN SSB mode zero-beat. Hold the main tuning knob from rotating and slip the calibration ring to the nearest major (5 kHz) graduation. The dial is now calibrated.

Note: For exact frequency, read the Digital Display.

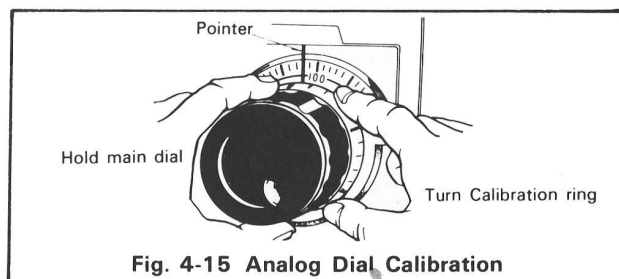

Fig. 4-15 Analog Dial Calibration

SECTION 5. ADDITIONAL INFORMATION

5.1 GENERAL INFORMATION

Your TS-130S(V) has been factory aligned and tested to specification before shipment. Under normal circumstances, the transceiver will operate in accordance with these operating instructions.

If your transceiver fails to work, contact the authorized dealer from whom you purchased it for quick, reliable repair. All adjustable trimmers and coils in your transceiver were preset at the factory and should only be readjusted by a qualified technician with proper test equipment. Attempting service or alignment without factory authorization can void the transceiver's warranty.

5.2 INSTALLING THE OPTIONAL FILTER

1. Using a #2 philips screwdriver, remove the top cover (8 screws). Be careful of the VOX controls, and the speaker lead, which may be unplugged.
2. Remove the bottom cover (7 screws).
3. Remove 6 screws from the IF unit and swing the board up and towards the center of the radio.
4. Using a 45W (or less) soldering pencil, clear the 6 holes for the filter, if they are filled with solder.

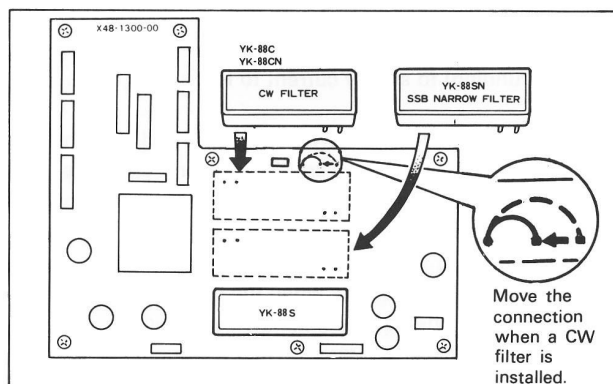
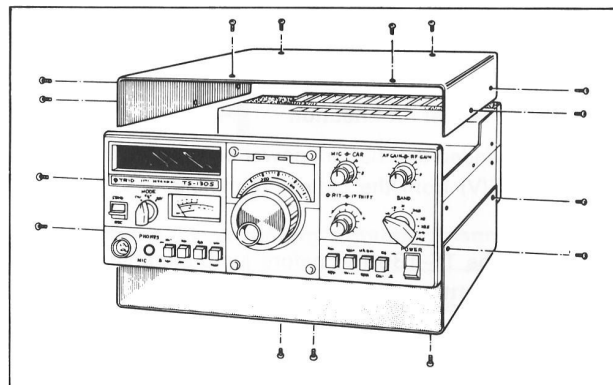

5. There is no polarity to the filter. Install the filter into its position on the IF unit. Solder the 2 mounting tabs, and the 4 input and output pins to the circuit board. Solder sparingly, and heat the connections only long enough to insure a good solder joint. Don't overheat the filter or circuit board.
6. Carefully inspect your soldering. Be certain that all pins are actually soldered, and that you have not soldered across any spots on the board or between any of the pins on the filter. Clip the pins flush to the board.
7. Replace the IF unit in its place. Make certain no wires will be pinched underneath the board. Replace the 6 screws.
8. Move the connector as illustrated when a CW filter is installed.
9. Reinstall the bottom cover. Reconnect the speaker lead, and reinstall the top cover.
10. Apply power and verify your work. Filter installation is now complete.

5.3 TS-130S(V) ANALOG DIAL ADJUSTMENT

1. Turn the main dial fully CCW. The red cursor should line up with the VFO start mark on the sub-dial. If it does not, remove the main knob, loosen set screws and line up the scale start point to the red cursor.
2. Turn the main knob to 50 kHz analog. Adjust the aluminum slip sub-dial to line up with any one of the larger black dial marks.
3. Note the digital error. If it is MORE than 2 kHz adjust the VFO trimmer capacitor TC1 (center under the seal tape) to exactly 50.0 on the digital readout.
4. Turn the main knob to 450 analog. If the digital error is less than 2 kHz it is in spec. If the digital error is greater, proceed:
For instance if the digital error is 14.454.0 (plus 4 kHz), multiply the error times 4 (16 kHz) and adjust the VFO trimmer cap to the desired frequency (14.450.0) LESS the error, or 14.434.0. Next adjust the VFO inductor L10 (front under the seal tape) back up to the desired frequency of 14.450.0.
5. If the error in step 4 was in the minus direction, reverse the direction of correction adjustment in step 4.
6. VFO linearity final check: The digital readout and analog dial should agree to within ± 2 kHz at every 100 kHz dial point.

5.4 HOW THE TX FINAL TRANSISTORS ARE PROTECTED

Final transistor protection is provided by sampling the reflected power. As the reflected power is increased (higher SWR) transmitter drive is reduced, thus decreasing input to the final transistors. This in turn reduces collector loss, protecting the final transistors.

5.5 TRANSMITTING ON WARC BANDS

As supplied, the TS-130S(V) will receive but not transmit on the 3 new WARC bands. If transmit capability is desired, a minor wiring change is required.

1. For all 3 bands: On the Rf unit X44-1380-00 unplug J5 (or cut the brown wire).
2. Of for individual Bands: On the RF unit:

Band	Remove (orcut) Part
10 MHz	D8
18 MHz	D9
24.5 MHz	D10

5.6 PHONE PATCH OPERATION

The PC-1 Phone Patch may be used with the TS-130S(V).

Recommended settings are:

PC-1	RX Gain	4
	TX Gain	4
	Null	as necessary
TS-130S(V)	Vox Gain	1
	AF Gain	4
	Mic Gain	5
	Anti Vox	Max

Most other phone patches will work satisfactorily without any modification to the radio, requiring only an external speaker connection, and that the Mic line be run through the patch.

For those operators who desire a Patch input similar to the TS-520SE or TS-820S, an input connection and terminal must be added at the Mic input preamp circuit.

Use a 100-K Ω resistor in series, with a 10-k Ω to ground on the input side of the 100-k Ω resistor. Use shielded line, and connect as follows:

On the AF Gen unit X49-1110-01 install the fixed divider at the junction of R43 10k, C42 100pf, and C43 1uF (input of Q18). Add an RCA jack, or use remote pins 7 and Gnd for input.

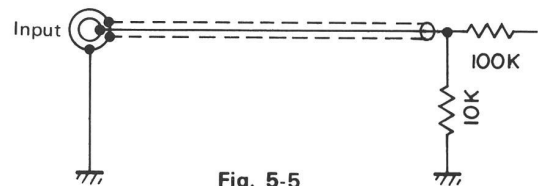

Fig. 5-5

5.7 ORDERING SPARE PARTS

When ordering replacement or spare parts for your equipment, be sure to specify the following:

- Model and serial number of your transceiver, Schematic number of the part, Printed circuit board number on which the part is located, Part number and name, if known, and Quantity desired.

NOTE:

A full service manual is available as a separate publication.

5.8 SERVICE

Should it ever become necessary to return the equipment for repair, pack in its original boxes and packing, and include a full description of the problems involved. Also include your telephone number. You need not return accessory items unless directly related to the service problem. Tag all returned items with your call for easy I.D.

You may return your radio for service to the Authorized Kenwood Dealer from whom you purchased it. A copy of the service report will be returned with the unit. Please do not send sub — assemblies or printed circuit boards — send the complete unit, in its original boxes and packing. If you want verification of receipt, please supply a self — addressed card (or letter) and you will be informed of the date of receipt and estimated service time.

SERVICE NOTE: Dear OM, if you desire to correspond on a technical or operational problem, please make your note short, complete, and to the point. And PLEASE make it readable.

Please list: Model and serial number.

The question or problem you are having. Please give sufficient detail to diagnose; other equipment in the station, meter readings and anything you feel might be useful in attempting diagnosis.

NOTES:

1. Record the date of purchase, serial number and dealer from whom purchased.
2. For your own information, retain a written record of any maintenance performed on the unit.
3. When claiming warranty service, please include a photocopy of the bill of sale, or other proof of purchase showing the date of sale.

SECTION 6. OPTIONAL ACCESSORIES

The following optional accessories are available for use with the TS-130S(V).

■ * Model PS-20 Regulated DC Power Supply

Perfectly matches the design and characteristics of the TS-130V, Equipped with a protection circuit which guards transceiver against damage due to shorts or overload.

■ Model PS-30 Regulated DC Power Supply

The PS-30 is a regulated DC power supply with a large capacity. The output is 13.8 VDC/20A (Intermittent). Since terminals for 13.8 VDC/5A are also provided, in addition to output power cables for use with the TS-130S, the PS-30 can be used as a power source for other mobile transceivers (such as 2-meter rigs).

■ Model AT-130 Antenna Tuner

The AT-130 is a compact antenna tuner designed for use with the TS-130 S(V) in either a mobile or fixed station. The SWR meter is illuminated so that it can be used in the car even at night. Also, it is equipped with a highly accurate SWR detecting circuit for matching within the impedance range between 20 and 300 ohms on all bands between 3.5 and 29.7 MHz.

■ Model DFC-230

A compact digital frequency controller with special design emphasis on mobile operation. It contains a digital VFO operating at 20 Hz steps and a 4 channel memory. Remote

frequency control by the up/down switch on the supplied microphone is possible, as is "cross" operation with the TS-130S(V).

■ Model VFO-120

The VFO-120 is an all solid-state VFO with high stability, designed to match the TS-130S(V) in design and performance. "Split frequency" operation is possible by using the TS-130S(V) with the VFO-120. Also, the T-F switch makes it possible to check the transmit frequency while in the receiving mode.

■ Model SP-120 External Speaker

The SP-120 is an external speaker designed exclusively for use with the TS-130S(V). It matches the TS-130S(V) in design and tone quality.

■ MICROPHONE MC-30S, MC-35S

Dynamic microphone with PTT switch specifically designed for mobile operation.

Impedance: 50 k Ω (MC-30S)

500 Ω (MC-35S)

■ MICROPHONE MC-50

Unidirectional dynamic microphone with locking PTT switch provides excellent performance for VOX operation.

Impedance: 50 k Ω and 600 Ω (switchable)