



MULTISOURCE GENERATOR 2026



Operating Manual

Document part no. 46892/439

Issue 3

6 April 2001

MULTISOURCE GENERATOR

2026

10 kHz to 2.4 GHz

Includes information on:

- Option 1 – Three internal signal sources.
- Option 3 – High-stability frequency standard.
- Option 4 – Rear-panel connections.

This manual applies to instruments with software issues of 10.00 and higher.

© IFR Ltd. 2007

No part of this book may be reproduced or transmitted in any form or by any means, electronic or mechanical, including photocopying, or recorded by any information storage or retrieval system, without permission in writing by IFR Ltd.

Printed in the UK

Manual part no. 46892/439
Issue 3

6 April 2001

About this manual

This manual explains how to use the 2026 Multisource Generator.

Intended audience

Persons who have a need for accurately generated signals in the VHF and UHF spectrum.

It is assumed that the reader will be familiar with telecommunication terms used in modern communication systems.

Structure

Chapter 1	Main features and performance data
Chapter 2	Installation details
Chapter 3	Local operation
Chapter 4	Source configuration, coupling and selected applications
Chapter 5	GPIB operation with keywords and sample programs
Chapter 6	Brief technical description
Chapter 7	Instructions for doing acceptance testing

Document conventions

The following conventions apply throughout this manual:

RF OUTPUT	Titles marked on the instrument panel are shown in capital letters.
[SET UP]	Key titles are as shown on the key-caps in square brackets.
<i>[Carrier Freq]</i>	Soft key titles are shown in italics in square brackets; for example, <i>[Carrier Freq]</i> means the soft key adjacent to the <i>Carrier Freq</i> title box at the side of the menu.
<i>RF Level</i>	Messages on the display are shown in italic letters.

Associated publications

Other publications covering specific aspects of this equipment are:

Maintenance Manual	(46882/295)	Covers maintenance and repair.
Service Manual	(46880/094)	Consists of operating manual (this document) plus maintenance manual.

Contents

PREFACE	iv
Precautions	v
Précautions	viii
Vorsichtsmaßnahmen	x
Precauzioni	xii
Precauciones	xiv
Chapter 1 GENERAL INFORMATION	1-1
Chapter 2 INSTALLATION	2-1
Chapter 3 LOCAL OPERATION	3-1
First-time use	3-9
Individual source operation	3-17
Sweep	3-27
Utilities	3-31
Memory	3-45
Error messages	3-49
Chapter 4 SETUP	4-1
Combiner setup	4-3
Coupling	4-5
Applications	4-7
Chapter 5 REMOTE OPERATION	5-1
Chapter 6 BRIEF TECHNICAL DESCRIPTION	6-1
Chapter 7 ACCEPTANCE TESTING	7-1
Test procedures	7-5
Acceptance test results tables	7-31
INDEX	I-1

PREFACE

PATENT PROTECTION

The 2026 Multisource Generator is protected by the following patents:

EP 0322139

GB 2214012

US 4870384

EP 0125790

GB 2140232

US 4609881

Precautions

WARNING

CAUTION

Note

These terms have specific meanings in this manual:

WARNING

information to prevent personal injury.

CAUTION



information to prevent damage to the equipment.

Note

important general information.

Hazard symbols

The meaning of hazard symbols appearing on the equipment is as follows:

Symbol	Description
	General hazard
	Toxic hazard

General conditions of use

This product is designed and tested to comply with the requirements of IEC/EN61010-1 'Safety requirements for electrical equipment for measurement, control and laboratory use', for Class 1 portable equipment and is for use in a pollution degree 2 environment. The equipment is designed to operate from an installation category 2 supply.

Equipment should be protected from the ingress of liquids and precipitation such as rain, snow, etc. When moving the instrument from a cold to a hot environment, it is important to allow the temperature of the instrument to stabilize before it is connected to the supply to avoid condensation forming. The instrument must only be operated within the environmental conditions specified in Chapter 1 'Performance data' in the Operating Manual otherwise the protection provided by the equipment may be impaired.

This product is not approved for use in hazardous atmospheres or medical applications. If the equipment is to be used in a safety-related application, e.g. avionics or military applications, the suitability of the product must be assessed and approved for use by a competent person.

WARNING



Electrical hazards (AC supply voltage)

This equipment conforms with IEC Safety Class I, meaning that it is provided with a protective grounding lead. To maintain this protection the supply lead must always be connected to the source of supply via a socket with a grounded contact.

Be aware that the supply filter contains capacitors that may remain charged after the equipment is disconnected from the supply. Although the stored energy is within the approved safety requirements, a slight shock may be felt if the plug pins are touched immediately after removal.

Do not remove covers, no user serviceable parts inside. See list of IFR Ltd International Service Centers at rear of manual.

Fuses

Note that the internal supply fuse is in series with the live conductor of the supply lead. If connection is made to a 2-pin unpolarized supply socket, it is possible for the fuse to become transposed to the neutral conductor, in which case, parts of the equipment could remain at supply potential even after the fuse has ruptured.

WARNING



Fire hazard

Make sure that only fuses of the correct rating and type are used for replacement.

If an integrally fused plug is used on the supply lead, ensure that the fuse rating is commensurate with the with current requirements of this equipment. See under 'Performance Data' in Chapter 1 for power requirements.

WARNING



Toxic hazards

Some of the components used in this equipment may include resins and other materials which give off toxic fumes if incinerated. Take appropriate precautions, therefore, in the disposal of these items.

WARNING



Beryllia

Beryllia (beryllium oxide) is used in the construction of some of the components in this equipment. This material, if incorrectly handled, could cause a danger to health – refer to the Maintenance part of the Service Manual for safe handling precautions.

WARNING



Beryllium copper

Some mechanical components within this instrument are manufactured from beryllium copper. This is an alloy with a beryllium content of approximately 5%. It represents no risk in normal use. The material should not be machined, welded or subjected to any process where heat is involved. It must be disposed of as “special waste”. It must NOT be disposed of by incineration.

WARNING



Heavy instrument

The weight of this instrument exceeds the 18 kg (40 lb) guideline for manual handling by a single person. To avoid the risk of injury, an assessment should be carried out prior to handling which takes account of the load, workplace environment and individual capability, in accordance with European Directive 90/269/EEC and associated National Regulations.

WARNING



Tilt facility

When the instrument is in the tilt position, it is advisable, for stability reasons, not to stack other instruments on top of it.

CAUTION

Static sensitive components

This equipment contains static sensitive components which may be damaged by handling – refer to the Maintenance Manual for handling precautions.

CAUTION

Suitability for use

This equipment has been designed and manufactured by IFR Ltd. to provide RF signals from two or three configurable sources. IFR Ltd. has no control over the use of this equipment and cannot be held responsible for events arising from its use other than for its intended purpose.

Précautions

WARNING

CAUTION

Note

Les termes suivants ont, dans ce manuel, des significations particulières:

WARNING

contient des informations pour éviter toute blessure au personnel.

CAUTION

contient des informations pour éviter les dommages aux équipements.

Note

contient d'importantes informations d'ordre général.

Symboles signalant un risque

La signification des symboles liés à cet équipement est la suivante:

Symbole

Nature du risque



Risques généraux



Danger produits toxiques

Conditions générales d'utilisation

Ce produit a été conçu et testé pour être conforme aux exigences des normes CEI/EN61010-1 "Règles de sécurité pour appareils électriques de mesure, de régulation et de laboratoire", pour des équipements Classe I portables et pour une utilisation dans un environnement de pollution de niveau 2. Cet équipement est conçu pour fonctionner à partir d'une alimentation de catégorie II.

Cet équipement doit être protégé de l'introduction de liquides ainsi que des précipitations d'eau, de neige, etc... Lorsqu'on transporte cet équipement d'un environnement chaud vers un environnement froid, il est important de laisser l'équipement se stabiliser en température avant de le connecter à une alimentation afin d'éviter toute formation de condensation. L'équipement doit être utilisé uniquement dans les conditions d'environnement spécifiées dans "Performance data" dans le chapitre 1 du manuel d'utilisation, toute autre utilisation peut endommager les systèmes de protection.

Ce produit n'est pas garanti pour fonctionner dans des atmosphères dangereuses ou pour un usage médical. Si l'équipement doit être utilisé pour des applications en relation avec la sécurité, par exemple des applications militaires ou aéronautiques, la compatibilité du produit doit être établie et approuvée par une personne compétente.

WARNING



Securite electrique (tension d'alimentation alternative)

Cet appareil est protégé conformément à la norme CEI de sécurité class 1, c'est-à-dire que sa prise secteur comporte un fil de protection à la terre. Pour maintenir cette protection, le câble d'alimentation doit toujours être branché à la source d'alimentation par l'intermédiaire d'une prise comportant une borne terre.

Notez que les filtres d'alimentation contiennent des condensateurs qui peuvent encore être chargés lorsque l'appareil est débranché. Bien que l'énergie contenue soit conforme aux exigences de sécurité, il est possible de ressentir un léger choc si l'on touche les bornes sitôt après débranchement.

Ne pas enlever les capots, aucune pièce réparable ne se trouve à l'intérieur. Contacter un des Centres de Maintenance Internationaux de IFR Ltd dans la liste jointe à la fin du manuel.

Fusibles

Notez que le fusible d'alimentation interne est en série avec la phase du câble d'alimentation. Si la prise d'alimentation comporte deux bornes non polarisées, il est possible de connecter le fusible au neutre. Dans ce cas, certaines parties de l'appareil peuvent rester à un certain potentiel même après coupure du fusible.

WARNING**Risque lie au feu**

Lors du remplacement des fusibles vérifiez l'exactitude de leur type et de leur valeur.

Si le câble d'alimentation comporte une prise avec fusible intégré, assurez vous que sa valeur est compatible avec les besoins en courant de l'appareil. Pour la consommation, reportez-vous au chapitre 1 "Spécifications".

WARNING**Danger produits toxiques**

Certains composants utilisés dans cet appareil peuvent contenir des résines et d'autres matières qui dégagent des fumées toxiques lors de leur incinération. Les précautions d'usages doivent donc être prises lorsqu'on se débarrasse de ce type de composant.

WARNING**Le Beryllia**

Le **Beryllia** (oxyde de Beryllium) entre dans la composition de certains composants de cet appareil. Cette matière peut représenter un danger pour la santé s'il elle n'est pas manipulée de façon correcte – se référer à la partie "Maintenance" du "Manuel de Maintenance" pour les précautions de manipulation.

WARNING**Bronze au béryllium**

Dans cet équipement, certaines pièces mécaniques sont à base de bronze au béryllium. Il s'agit d'un alliage dans lequel le pourcentage de béryllium ne dépasse pas 5%. Il ne présente aucun danger en utilisation normale.

Toutefois, cet alliage ne doit pas être travaillé, soudé ou soumis à un processus qui implique l'utilisation d'une source de chaleur.

En cas de destruction, il sera entreposé dans un container spécial. IL ne devra pas être détruit par incinération.

WARNING**Instrument lourd**

Le poids de cet appareil est supérieur à la limite de 18 kg (40 lb), fixée pour le transport par une seule personne. Afin d'éviter tout risque de blessure, il est nécessaire de faire, avant le transport, une évaluation de la charge, des contraintes de l'environnement et des capacités de l'individu, en conformité avec la Directive Européenne 90/269/EEC ainsi que les recommandations Nationales concernées.

WARNING**Position inclinée**

Lorsque l'appareil est dans une position inclinée, il est recommandé, pour des raisons des stabilité, de ne pas y empiler d'autres appareils.

Vorsichtsmaßnahmen

WARNING

CAUTION

Note

Diese Hinweise haben eine bestimmte Bedeutung in diesem Handbuch:

WARNING

dienen zur Vermeidung von Verletzungsrisiken.

CAUTION

dienen dem Schutz der Geräte.

Note

enthalten wichtige Informationen.

Gefahrensymbole

Die Gefahrensymbole auf den Geräten sind wie folgt:

Symbol

Gefahrenart



Allgemeine Gefahr



Warnung vor giftigen Substanzen

Allgemeine Hinweise zur Verwendung

Dieses Produkt wurde entsprechend den Anforderungen von IEC/EN61010-1 "Sicherheitsanforderungen für elektrische Ausrüstung für Meßaufgaben, Steuerung und Laborbedarf", Klasse I, transportabel zur Verwendung in einer Grad 2 verunreinigten Umgebung, entwickelt und getestet. Dieses Gerät ist für Netzversorgung Klasse II zugelassen.

Das Gerät sollte vor dem Eindringen von Flüssigkeiten sowie vor Regen, Schnee etc. geschützt werden. Bei Standortänderung von kalter in wärmere Umgebung sollte das Gerät wegen der Kondensation erst nach Anpassung an die wärmere Umgebung mit dem Netz verbunden werden. Das Gerät darf nur in Umgebungsbedingungen wie in Kapitel 1 "Leistungsdaten (Performance data)" der Bedienungsanleitung beschrieben, betrieben werden; ansonsten wird der vom Gerät vorgesehene Schutz des Anwenders beeinträchtigt.

Dieses Produkt ist nicht für den Einsatz in gefährlicher Umgebung (z.B. Ex-Bereich) und für medizinische Anwendungen geprüft. Sollte das Gerät für den Einsatz in sicherheitsrelevanten Anwendungen wie z.B. im Flugverkehr oder bei militärischen Anwendungen vorgesehen sein, so ist dieser von einer für diesen Bereich zuständigen Person zu beurteilen und genehmigen.

WARNING



Elektrische Schläge (Wechselspannungsversorgung)

Das Gerät entspricht IEC Sicherheitsklasse 1 mit einem Schutzleiter nach Erde. Das Netzkabel muß stets an eine Steckdose mit Erdkontakt angeschlossen werden.

Filterkondensatoren in der internen Spannungsversorgung können auch nach Unterbrechung der Spannungszuführung noch geladen sein. Obwohl die darin gespeicherte Energie innerhalb der Sicherheitsmargen liegt, kann ein leichter Spannungsschlag bei Berührung kurz nach der Unterbrechung erfolgen.

Entfernen Sie keine Gehäuseabdeckungen, es befinden sich keine austauschbaren Teile im Gerät. Eine Liste der IFR Servicestellen finden Sie auf der Rückseite des Handbuchs.

Sicherungen

Die interne Sicherung in der Spannungszuführung ist in Reihe mit der spannungsführenden Zuleitung geschaltet. Bei Verbindung mit einer zweiadrigen, nicht gepolten Steckdose kann die Sicherung in der Masseleitung liegen, so daß auch bei geschmolzener Sicherung Geräteteile immer noch auf Spannungspotential sind.

WARNING**Feuergefahr**

Es dürfen nur Ersatzsicherungen vom gleichen Typ mit den korrekten Spezifikationen entsprechend der Stromaufnahme des Gerätes verwendet werden. Siehe hierzu die Leistungsdaten (Performance Data) in Kapitel 1.

WARNING**Warnung vor giftigen Substanzen**

In einigen Bauelementen dieses Geräts können Epoxyharze oder andere Materialien enthalten sein, die im Brandfall giftige Gase erzeugen. Bei der Entsorgung müssen deshalb entsprechende Vorsichtsmaßnahmen getroffen werden.

WARNING**Beryllium Oxid**

Beryllium Oxid wird in einigen Bauelementen verwendet.

Bei inkorrektter Handhabung kann dieses Material Gesundheitsschäden verursachen. Siehe hierzu die Hinweise zur Handhabung im Service-Handbuch.

WARNING**Beryllium Kupfer**

In diesem Gerät sind einige mechanische Komponenten aus Beryllium Kupfer gefertigt. Dies ist eine Verbindung welche aus einem Berylliumanteil von ca. 5 % besteht. Bei normaler Verwendung besteht kein Gesundheitsrisiko.

Das Metall darf nicht bearbeitet, geschweißt oder sonstiger Wärmebehandlung ausgesetzt werden.

Es muß als Sondermüll entsorgt werden.

Es darf nicht durch Verbrennung entsorgt werden.

WARNING**Schweres Gerät**

Das Gewicht dieses Geräts liegt über der 18 kg (40 lb) Grenze für Transport durch eine einzelne Person. Zur Vermeidung von Verletzungen sollten vor einem Transport die Arbeitsumgebung und die persönlichen Möglichkeiten im Verhältnis zur Last abgewogen werden, wie in der EU-Regelung 90/269/EEC und nationalen Normen beschrieben.

WARNING**Schrägstellung**

Bei Schrägstellung des Geräts sollten aus Stabilitätsgründen keine anderen Geräte darauf gestellt werden.

Precauzioni

WARNING

CAUTION

Note

Questi termini vengono utilizzati in questo manuale con significati specifici:

WARNING

riportano informazioni atte ad evitare possibili pericoli alla persona.

CAUTION

riportano informazioni per evitare possibili pericoli all'apparecchiatura.

Note

riportano importanti informazioni di carattere generale.

Simboli di pericolo

Significato dei simboli di pericolo utilizzati nell'apparato:

Simbolo

Tipo di pericolo



Pericolo generico



Pericolo sostanze tossiche

Condizioni generali d'uso.

Questo prodotto è stato progettato e collaudato per rispondere ai requisiti della direttiva IEC/EN61010-1 'Safety requirements for electrical equipment for measurement, control and laboratory use' per apparati di classe I portatili e per l'uso in un ambiente inquinato di grado 2. L'apparato è stato progettato per essere alimentato da un alimentatore di categoria II.

Lo strumento deve essere protetto dal possibile ingresso di liquidi quali, ad es., acqua, pioggia, neve, ecc. Qualora lo strumento venga portato da un ambiente freddo ad uno caldo, è importante lasciare che la temperatura all'interno dello strumento si stabilizzi prima di alimentarlo per evitare formazione di condense. Lo strumento deve essere utilizzato esclusivamente nelle condizioni ambientali descritte nel capitolo 1 'Performance Data' del manuale operativo, in caso contrario le protezioni previste nello strumento potrebbero risultare non sufficienti.

Questo prodotto non è stato approvato per essere usato in ambienti pericolosi o applicazioni medicali. Se lo strumento deve essere usato per applicazioni particolari collegate alla sicurezza (per esempio applicazioni militari o avioniche), occorre che una persona o un istituto competente ne certifichi l'uso.

WARNING



Pericoli da elettricità (alimentazione c.a.)

Quest' apparato è provvisto del collegamento di protezione di terra e rispetta le norme di sicurezza IEC, classe 1. Per mantenere questa protezione è necessario che il cavo, la spina e la presa d'alimentazione siano tutti provvisti di terra.

Il circuito d'alimentazione contiene dei filtri i cui condensatori possono restare carichi anche dopo aver rimosso l'alimentazione. Sebbene l'energia immagazzinata è entro i limiti di sicurezza, purtroppo una leggera scossa può essere avvertita toccando i capi della spina subito dopo averla rimossa.

Non rimuovere i coperchi, utilizzare solo parti di scorta originali. Vedi elenco internazionale dei Centri di Assistenza in fondo al manuale.

Fusibili

Notare che un fusibile è posto sul filo caldo del cavo di alimentazione. Qualora l'alimentazione avvenga tramite due poli non polarizzati, è possibile che il fusibile vada a protezione del neutro per cui anche in caso di una sua rottura, l'apparato potrebbe restare sotto tensione.

WARNING**Pericolo d'incendio**

Assicurarsi che, in caso di sostituzione, vengano utilizzati solo fusibili della portata e del tipo prescritto.

Se viene usata una spina con fusibili, assicurarsi che questi siano di portata adeguata coi requisiti di alimentazione richiesti dallo strumento. Tali requisiti sono riportati nel cap. 1 "Performance data".

WARNING**Pericolo sostanze tossiche**

Alcuni dei componenti usati in questo strumento possono contenere resine o altri materiali che, se bruciati, possono emettere fumi tossici. Prendere quindi le opportune precauzioni nell'uso di tali parti.

WARNING**Berillio**

Berillio (ossido di berillio) è utilizzato nella costruzione di alcuni componenti di quest'apparato.

Questo materiale, se maneggiato non correttamente, può causare danni alla salute. Far riferimento ai capitoli di manutenzione del Manuale di Servizio per le precauzioni richieste.

WARNING**Rame berillio**

Alcuni componenti meccanici in questo strumento sono realizzati in rame berillio. Si tratta di una lega con contenuto di berillio di circa il 5%, che non presenta alcun rischio in usi normali.

Questo materiale non deve essere lavorato, saldato o subire qualsiasi processo che coinvolge alte temperature.

Deve essere eliminato come "rifiuto speciale". Non deve essere eliminato tramite "inceneritore".

WARNING**Strumento pesante**

Il peso di questo strumento supera i 18 kg (40 lb) raccomandati come limite per il trasporto manuale da parte di singola persona. Per evitare rischi di danni fisici è bene quindi considerare il carico complessivo, le condizioni del trasporto e le capacità individuali in accordo con la direttiva comunitaria 90/269/EEC e con eventuali regolamenti locali.

WARNING**Posizionamento inclinato**

Quando lo strumento è in posizione inclinata è raccomandato, per motivi di stabilità, non sovrapporre altri strumenti.

Precauciones

WARNING

CAUTION

Note

Estos términos tienen significados específicos en este manual:

WARNING

contienen información referente a prevención de daños personales.

CAUTION

contienen información referente a prevención de daños en equipos.

Note

contienen información general importante.

Símbolos de peligro

Los significados de los símbolos de peligro que aparecen en los equipos son los siguientes:

Símbolo

Naturaleza del peligro



Peligro general



Aviso de toxicidad

Condiciones generales de uso

Este producto ha sido diseñado y probado para cumplir los requerimientos de la normativa IEC/EN61010-1 "Requerimientos de la normativa para equipos eléctricos de medida, control y uso en laboratorio", para equipos clase II portátiles y para uso en un ambiente con un grado de contaminación 2. El equipo ha sido diseñado para funcionar sobre una instalación de alimentación de categorías II.

Debe protegerse el equipo de la entrada de líquidos y precipitaciones como nieve, lluvia, etc. Cuando se traslada el equipo de entorno frío a un entorno caliente, es importante aguardar la estabilización del equipo para evitar la condensación. Sólo debe utilizarse el aparato en las condiciones ambientales especificadas en el capítulo 1 "Especificaciones" o "Performance Data" del Manual de Operación/Funcionamiento, en caso contrario la propia protección del equipo puede resultar dañada.

Este producto no ha sido aprobado para su utilización en entornos peligrosos o en aplicaciones médicas. Si se va a utilizar el equipo en una aplicación con implicaciones en cuanto a seguridad, como por ejemplo aplicaciones de aviónica o militares, es preciso que un experto competente en materia de seguridad apruebe su uso.

WARNING



Nivel peligroso de electricidad (tensión de red)

Este equipo cumple las normas IEC Seguridad Clase 1, lo que significa que va provisto de un cable de protección de masa. Para mantener esta protección, el cable de alimentación de red debe de conectarse siempre a una clavija con terminal de masa.

Tenga en cuenta que el filtro de red contiene condensadores que pueden almacenar carga una vez desconectado el equipo. Aunque la energía almacenada está dentro de los requisitos de seguridad, pudiera sentirse una ligera descarga al tocar la clavija de alimentación inmediatamente después de su desconexión de red.

No quitar las tapas, en el interior no existen piezas reemplazables por el usuario. Vea la lista de Centros de Servicios Internacionales en la parte trasera del manual.

Fusibles

Se hace notar que el fusible de alimentación interno está en serie con el activo del cable de alimentación a red. Si la clavija de alimentación de red cuenta con sólo dos terminales sin polaridad, el fusible puede pasar a estar en serie con el neutro, en cuyo caso existen partes del equipo que permanecerían a tensión de red incluso después de que el fusible haya fundido.

WARNING**Peligro de incendio**

Asegúrese de utilizar sólo fusibles del tipo y valores especificados como recuento.

Si se utiliza una clavija con fusible incorporado, asegúrese de que los valores del fusible corresponden a los requeridos por el equipo. Ver sección de especificaciones del capítulo 1 para comprobar los requisitos de alimentación.

WARNING**Aviso de toxicidad**

Alguno de los componentes utilizados en este equipo pudieran incluir resinas u otro tipo de materiales que al arder produjeran sustancias tóxicas. Por tanto, tome las debidas precauciones en la manipulación de esas piezas.

WARNING**Berilio**

Berilio (óxido de berilio) Este material es utilizado en la fabricación de alguno de los componentes de este equipo.

Si se manipula incorrectamente podría causar daños a la salud – En la sección de mantenimiento y reparación encontrará normas de manejo de seguridad.

WARNING**Berilio-cobre**

Algunos componentes mecánicos contenidos en este instrumento incorporan berilio-cobre en su proceso de fabricación. Se trata de una aleación con un contenido aproximado de berilio del 5%, lo que no representa ningún riesgo durante su uso normal.

El material no debe ser manipulado, soldado, ni sometido a ningún proceso que implique la aplicación de calor.

Para su eliminación debe tratarse como un "residuo especial". El material NO DEBE eliminarse mediante incineración.

WARNING**Instrumento pesado**

El peso de este instrumento excede de los 18 kg (40 lb), lo que debe tenerse en cuenta si va ser transportado manualmente por una sola persona. Para evitar el riesgo de lesiones, antes de mover el equipo deberá evaluar la carga, el entorno de trabajo y la propia capacidad, de acuerdo con la Directiva Europea 90/269/EEC y el Reglamento Nacional Asociado.

WARNING**Tener en cuenta con el equipo Inclinado**

Si utiliza el equipo en posición inclinada, se recomienda, por razones de estabilidad, no apilar otros equipos encima de él.

Chapter 1

GENERAL INFORMATION

Contents

Introduction.....	1-1
Main features	1-2
Operation	1-2
Display	1-2
Frequency selection	1-2
Output	1-2
Modulation.....	1-2
Incrementing	1-3
Frequency sweep	1-3
Memory.....	1-3
Programming	1-3
Calibration data.....	1-3
Spectral purity.....	1-3
Calibration	1-3
Performance data	1-4
Versions, options and accessories.....	1-9

Introduction

The 2026 is a multisource signal generator offering as standard two signal sources in one instrument. Up to three sources may be fitted, each of which is a fully functional modulated signal generator. Each source can either be routed to its own individual RF output or switched to the input of an RF combiner network before being fed to a separate combined RF output. All sources cover the frequency range 10 kHz to 2.4 GHz. An additional RF input is provided to enable the output from an external RF signal generator to be combined with the signals from up to two internal sources.

Each signal source can be controlled independently in frequency and level, and each has its own amplitude, frequency, phase, FSK and pulse modulation capability. All parameters can be entered from the front-panel keyboard and a rotary control can be used to adjust most settings. The instrument includes a GPIB interface which allows remote control of all standard signal generator functions except the supply switch.

The instrument is provided with built-in tests specifically for use with two or three combined sources such as for amplifier and receiver intermodulation tests and receiver selectivity tests. The sources may be locked together, offset in frequency (additionally with a harmonic or sub-harmonic relationship) as well as level.

Microprocessor control ensures that the instrument is flexible and easy to use and allows programming by the General Purpose Interface Bus (GPIB) or RS-232 serial bus. The GPIB is designed to IEEE Standard 488.2 and is a means of sending commands to an instrument, via a data bus, from a remote controller or personal computer. The instrument can therefore be used manually or as part of a fully automated test system.

Main features

Operation

Selection of parameters on the screen may involve one or more of the numeric, hard or menu selection keys or the rotary control knob. Parameters may be set to specific values by numeric key entry, while values may be varied in steps of any size using the [↓][↑] keys or altered by moving the control knob, set to a particular sensitivity.

Display

The display is a dot matrix liquid crystal panel, with backlighting. Display contrast and brightness may be varied to accommodate differing lighting conditions and the setting saved in memory.

Frequency selection

Carrier frequency is either selected directly via the keyboard or remotely via the interfaces. Frequency resolution is 1 Hz across the complete frequency range of 10 kHz to 2.4 GHz. A series of carrier frequencies can be stored in non-volatile memory for recall when required.

Output

Peak RF output levels from each signal source of up to +24 dBm can be set up to 1.2 GHz (+20 dBm up to 2.4 GHz) by direct keyboard entry with a resolution of 0.1 dB down to -137 dBm. The peak output level from the combiner is +4 dBm up to 1.2 GHz (0 dBm up to 2.4 GHz). RF ON/OFF keys are provided to disable each individual output as well as the combined output.

A choice of level units is available to the user and provision is made for the conversion of units (for example, dBm to μ V) by a simple keypress.

An electronic trip protects each independent signal source output against reverse power of up to 50 W. This prevents damage to output circuits when RF transmitter or DC power supply is accidentally applied to an RF OUTPUT connector.

To facilitate testing of receiver squelch systems, an attenuator hold function allows control of the RF output without introducing RF level drop-outs from the step attenuator.

Modulation

Comprehensive amplitude, frequency and phase modulations are available. Pulse modulation can be applied to the carrier from an external pulse source. The instrument also produces FSK modulated outputs. An internal modulation oscillator is provided, having a frequency range of 0.01 Hz to 20 kHz. Sine, triangle and square waveforms are available. The oscillator is capable of generating one or two modulation tones simultaneously in one modulation channel. A BNC connector on the front panel offers access to the internal LF signal as well as providing an input for external modulation signals to be combined with the internal signals. These sources can be combined to give a number of modulation modes. The pulse modulation can be used in combination with the other forms of modulation.

The frequency modulation range provides a 1 dB bandwidth of typically 100 kHz and provides FM deviation of 0 to 100 kHz. AC or DC coupled FM can be selected. Phase modulation is provided with a 3 dB bandwidth of 10 kHz and deviation range of 0 to 10 radians.

Amplitude modulation with a 1 dB bandwidth of typically 30 kHz and with modulation depths of up to 99.9% is available with a resolution of 0.1%. Pulse modulation is available as standard with typical rise and fall times of less than 10 μ s and 40 dB on/off ratio.

The instrument also accepts one or two logic level inputs to produce a 2-level or 4-level FSK modulated output. The required FM deviation is set by keyboard entry.

The external input voltage required for specified modulation is 1 V RMS (1.414 V peak). To accommodate other signal levels, Automatic Level Control (ALC) can be selected which provides correctly calibrated modulation for inputs between 0.75 and 1.25 V RMS.

A modulation ON/OFF soft key simplifies the testing of signal-to noise-ratio.

Incrementing

All major parameters can be incremented or decremented in step sizes entered via keyboard entry or remotely. If no step size is entered for a parameter, the steps are preset to 1 kHz for carrier frequency, 1 kHz for modulation oscillator, 1 kHz for FM deviation, 0.1% for AM depth, 0.01 rad for Φ M and 1 dB for output level.

In addition, the rotary control knob can be used to vary the parameter with the sensitivity of the knob being changed by means of the [$\times 10$] and [$\div 10$] keys.

Control knob operation can be assigned for the adjustment of one parameter, while another parameter is adjusted by the increment and decrement keys. By this means two parameters, for example carrier frequency and RF level, can be adjusted simultaneously.

Frequency sweep

The sweep capability of the instrument allows comprehensive testing of systems. Four parameters are used to specify sweep; start, stop, step size and time per step, all of which may be specified by the user. The sweep can be paused at any time and the frequency and level manually altered. During the sweep the RF level can be altered using the rotary control. Sweep triggering can be single shot or continuous and can be initiated directly or on the detection of a trigger. The triggering signal may either be programmed or from a TTL signal applied to the rear-panel TRIGGER 1 input. When frequency coupling is enabled, the coupled sources will track with the swept source.

Memory

The instrument provides both non-volatile and volatile memory for storing instrument settings. The non-volatile memory provides 100 full instrument settings and 100 settings of carrier frequency only. The volatile memory (RAM) also provides 100 instrument settings. Any one of the non-volatile instrument settings can be selected as the power-up setting for the instrument.

Software protection

To prevent accidental interference with the contents of internal memories, internal data is protected.

Programming

A GPIB interface is fitted so that all functions are controllable via the interface bus which is designed to the IEEE Standard 488.2. The instrument can function both as talker and listener. The instrument also has an RS-232 interface which uses the common GPIB command set to control the instrument and also allow new software upgrades or applications to be downloaded into the instrument.

Calibration data

All alignment data is digitally derived. Realignment can be undertaken, without removing covers, by protected front-panel functions or via the GPIB interface.

Spectral purity

With an SSB phase noise performance of typically -121 dBc/Hz at 20 kHz offset from a 1 GHz carrier, these instruments can be used for both in-channel and adjacent channel receiver measurements. Harmonically-related signals and non-harmonics are typically better than -30 dBc and -60 dBc respectively.

Calibration

This instrument has a recommended two-year calibration interval after which it should be returned for recalibration (for addresses refer to 'International Service Centers' section at end of manual).

Performance data

Carrier frequency

Range: 10 kHz to 2.4 GHz with a resolution of 1 Hz.

Accuracy: As frequency standard.

RF output

Range

Individual outputs: -137 dBm to +24 dBm
(output power above +20 dBm is uncalibrated for carrier frequencies above 1.2 GHz).

Combined output: -137 dBm to +4 dBm (settable to +10 dBm)
(output power above 4 dBm is uncalibrated for carrier frequencies above 1.2 GHz; output power is uncalibrated at all levels for carrier frequencies below 1 MHz).

Maximum output is reduced by 5 dB when pulse modulation is selected and/or by up to 6 dB when AM is selected, dependent upon set AM depth.

Resolution: 0.1 dB.

RF level units: Units may be set to μ V, mV, EMF or PD; dB relative to 1 μ V, 1 mV, EMF or PD; or dBm. Conversion between dB and linear units may be achieved by pressing the appropriate units key (dB or V, mV, μ V). The output level can be normalized for 75 Ω operation with an external impedance converter (applies to all outputs simultaneously).

Accuracy:

Up to 1.2 GHz (over temperature range 17°C to 27°C):

RF level	-127 dBm to +6 dBm	+6 dBm to +24 dBm [†]
Individual outputs	± 0.8 dB	± 1.0 dB

RF level	>-127 dBm to +4 dBm [‡]	
Combiner output	± 1.0 dB	

Up to 2.4 GHz (over temp range of 17°C to 27°C):

RF level	-127 dBm to +6 dBm	+6 dBm to +20 dBm
Individual outputs	± 1.6 dB	± 2.0 dB

RF level	>-127 dBm to 0 dBm	
Combiner output	± 2.0 dB	

Temp stability	<1.2 GHz	>1.2 GHz
dB/°C	$< \pm 0.02$	$< \pm 0.04$

RF level tracking*

(over a temperature range of +17°C to +27°C):

The relative level accuracy between any two or more combined signals of equal amplitude is typically:

	1 MHz–1.2 GHz	1.2 GHz–2.4 GHz
-18 to +4 dBm	± 0.3 dB	± 0.6 dB
<-18 dBm	± 0.6 dB	± 1.2 dB

Attenuator hold:

Inhibits operation of the step attenuator from the level at which the key is enabled. Usable for a level reduction of at least 10 dB. Typical accuracy ± 3 dB.

* This specification does not apply to external RF input signals to combiner.

[†] Level accuracy is unspecified below 100 kHz for levels greater than +6 dBm.

[‡] Level accuracy is unspecified below 1 MHz.

VSWR

- Individual outputs: For output levels less than -5 dBm, output VSWR is less than 1.5:1 for carrier frequencies up to 1.2 GHz and less than 1.7:1 up to 2.4 GHz.
- Combined output: Output VSWR is less than 1.22:1 for carrier frequencies between 1 MHz and 1.2 GHz, and less than 1.32:1 up to 2.4 GHz.
- Output connector: 50 Ω, type N connector to MIL 390123D.
- Output protection
 - Individual outputs: Protected from a source of reverse power up to 50 W from 50 Ω, or 25 W from a source VSWR of 5:1. Protection circuit can be reset from the front panel or via the GPIB or RS-232 interface.
 - Combined output: No reverse power protection. Maximum total safe power 0.5 W.

Spectral purity

- Harmonics:
 - Individual outputs: Typically better than -30 dBc for RF levels up to +6 dBm and typically better than -25 dBc for RF levels up to +18 dBm (+14 dBm above 1.2 GHz).
 - Combined output: Typically better than -30 dBc for RF levels up to -14 dBm and typically better than -25 dBc for RF levels up to +4 dBm (0 dBm above 1.2 GHz). Harmonics unspecified below 1 MHz.
- Non-harmonics (for offsets >3 kHz): Better than -70 dBc for carrier frequencies up to 1 GHz; better than -64 dBc for carrier frequencies above 1 GHz; better than -60 dBc for carrier frequencies above 2 GHz.
- Isolation: Better than 80 dB between individual outputs in use. Better than 60 dB from a used individual output to the combiner output. Better than 40 dB between the combiner output and an unused individual output.

Intermodulation:

At an RF output level of 0 dBm on the combiner into a load VSWR of 2:1 or better:

Frequency range	2-tone intermod*
10 MHz to 2.4 GHz	<-80 dBc
5 MHz to 10 MHz	<-75 dBc
Usable but unspecified down to 1 MHz	

*Third-order intermodulation products.

Intermodulation levels reduce with reducing RF levels.

- Residual FM (FM off): Less than 4.5 Hz RMS deviation in a 300 Hz to 3.4 kHz unweighted bandwidth at a carrier frequency of 1 GHz.
Typically <1 Hz at 249 MHz, <2 Hz at 501 MHz, <3 Hz at 1001 MHz, <6 Hz at 2001 MHz.
- SSB phase noise: Better than -124 dB/Hz at 20 kHz offset from a 470 MHz carrier. Typically better than -121 dBc/Hz at 20 kHz offset from a 1 GHz carrier.
- Carrier leakage: Less than 0.5 μV PD at the carrier frequency into a 2-turn 25 mm diameter loop 25 mm from the surface of the signal generator.
- External RF input: The following applies when an external input is connected at the rear panel and the combiner is set up for 'independent' external RF input.
 - Insertion loss: 14.75 dB ±1 dB.
 - Frequency range: 10 kHz to 4 GHz (usable to 5 GHz).
 - Return loss: >20 dB to 2.4 GHz.
 - Max input power: 0.5 W.

Modulation

FM, AM or phase modulation can be applied to the carriers generated by each signal source from independent internal or external modulation sources. The internal modulation sources are capable of generating two simultaneous signals into any one of the modulation channels. Each internal and external modulation source can be enabled simultaneously to produce combined amplitude and frequency (or phase) modulation. Pulse modulation can be applied to each of the carriers from external pulse sources. The pulse modulation can be used in combination with the other forms of modulation. 2-level or 4-level FSK modulation can be applied to each carrier using data from an external source.

Frequency modulation

Deviation: 0 to 100 kHz.

Resolution: 3 digits or 1 Hz.

Accuracy: $\pm 5\%$ at 1 kHz modulation rate.

Bandwidth (1 dB): DC to 100 kHz (DC coupled),
10 Hz to 100 kHz (AC coupled),
20 Hz to 100 kHz (AC coupled with ALC).

Group delay: Less than 5 μs to 100 kHz.

Carrier frequency offset: Less than 1% of the set frequency deviation when DC coupled.

Distortion: Less than 1% at 1 kHz rate for deviations up to 100 kHz,
typically $\leq 0.3\%$ at 1 kHz rate for deviations up to 10 kHz.
Less than 3% at 1 kHz rate and deviations up to 100 kHz for carrier frequencies below 50 MHz.

Modulation source: Internal modulation oscillator or external via front-panel BNC.

FSK

Modes: 2-level or 4-level FSK.

Data source: External data via rear-panel 25-way D-type connector.

Frequency shift: Variable up to ± 100 kHz.

Accuracy: As FM deviation accuracy.

Timing jitter: ± 3.2 μs .

Filter: 8th-order Bessel, -3 dB at 20 kHz.

Phase modulation

Deviation range: 0 to 10 radians.

Resolution: 3 digits or 0.01 radians.

Accuracy at 1 kHz: $\pm 5\%$ of indicated deviation excluding residual phase modulation.

Bandwidth (3 dB): 100 Hz to 10 kHz.

Distortion: Less than 3% at 10 radians at 1 kHz modulation rate. Typically $< 0.5\%$ for deviations up to 1 radian at 1 kHz.

Modulation source: Internal LF generator or external via front panel BNC.

Amplitude modulation

Individual outputs For carrier frequencies < 500 MHz, usable to 1.5 GHz.

Combined output Unspecified below 5 MHz; usable to 1 MHz. Otherwise as for individual outputs.

Range: 0 to 99.9%.

Resolution: 0.1%.

Accuracy*: $\pm 5\%$ of set depth at 1 kHz rate, over temperature range 17°C to 27°C .
Temperature coefficient $< 0.02\%/^{\circ}\text{C}$.

Bandwidth (1 dB): DC to 30 kHz (DC coupled),
10 Hz to 30 kHz (AC coupled),
20 Hz to 30 kHz (AC coupled with ALC).

Distortion*: $< 1.5\%$ at 1 kHz rate for modulation depths up to 30%,
 $< 2.5\%$ at 1 kHz rate for modulation depths up to 80%.

Modulation source: Internal LF generator or external via front panel BNC.

Φ M on AM: Typically 0.1 radian at 30% depth at 470 MHz.

*For RF levels not exceeding +10 dBm (individual output) or -4 dBm (combined output).

Pulse modulation

Carrier frequency range: 32 MHz to 2.4 GHz, usable to 10 MHz.
 RF level range: Maximum guaranteed output is reduced by 5 dB when pulse modulation is selected.
 RF level accuracy: When pulse modulation is enabled, adds ± 0.5 dB to the RF level accuracy specification.
 Control: Front-panel BNC connector with an input impedance of 10 k Ω nominal. A logical '1' (3.5 to 5 V) turns the carrier on, a logical '0' (0 to 1 V) turns the carrier off. Maximum input is ± 15 V.
 On-off ratio: Better than 45 dB below 1.2 GHz, better than 40 dB above 1.2 GHz.
 Rise and fall time: Less than 10 μ s.
 Overshoot: Less than 1 dB

Modulation oscillator

The internal modulation oscillator for each signal source is capable of generating one or two modulation tones simultaneously in one modulation channel.
 Frequency range: 0.01 Hz to 20 kHz with a resolution of 0.01 Hz.
 Frequency accuracy: As frequency standard.
 Distortion: Less than 0.1% THD at 1 kHz.
 Waveforms: Sine to 20 kHz, triangle or square wave to 3 kHz.
 Square wave jitter: Less than 6.4 μ s on any edge.
 Audio output: The modulation oscillator signal from each source is available from the modulation input/output BNC connector at a nominal level of 2 V RMS EMF from a 600 Ω source impedance.

External modulation

A front-panel external modulation input/output BNC connector is provided.
 Input level: 1 V RMS (1.414 V peak) sine wave for set deviation. Maximum safe input is ± 15 V.
 Input impedance: 100 k Ω nominal.
 Modulation ALC: Levels the applied external modulation over the range 0.75 to 1.25 V RMS sine wave. High and low indicators in display indicate when the input is outside leveling range.
 Sweep mode: The carrier frequency of one source can be swept. To enable more than one source to be swept the coupling facility must be invoked.
 Control parameters: Start/stop values of carrier frequency, frequency step size and time per step.
 Step time: 50 ms to 10 s per step.
 Trigger: A trigger input is available on a rear-panel BNC connector and can be used in single, continuous, start/stop or single-step mode.

Frequency standard

TCXO: 10 MHz.
 Temperature stability: Better than ± 5 in 10^7 over the operating range 0 to 55°C.
 Aging rate: Less than ± 1 in 10^6 per year.
 External input/output: Rear-panel BNC connector accepts an input of 1 MHz or 10 MHz at 220 mV RMS to 1.8 V RMS into 1 k Ω .
 Rear-panel BNC connector provides an output of 10 MHz at a nominal level of 2 V pk-pk into 50 Ω .

Remote control

GPIB interface: All signal source parameters except the supply switch are remotely programmable.
 Capabilities: Designed in accordance with IEEE 488.2.
 Complies with the following subsets as defined in IEEE Std 488.1: SH1, AH1, T6, L4, SR1, RL1, PP0, DC1, DT1, C0, E2.

GENERAL INFORMATION

RS-232:	All signal source parameters except the supply switch are remotely programmable.			
Connector:	9-way male D-type			
Baud rate:	300 to 9600 bit/s.			
Handshake:	Hardware: DTR, RTS, CTS and DSR. Software: XON and XOFF.			
Electrical interface:	Interface to EIA-232-D.			
Electromagnetic compatibility	Conforms with the protection requirements of Council Directive 89/336/EEC. Conforms with the limits specified in the following standards: IEC/EN 61326-1 : 1997, RF Emission Class B, Immunity Table 1, Performance Criterion B			
Safety	Conforms with the requirements of EEC Council Directive 73/23/EEC and Standards IEC/EN 61010-1 : 1993. This instrument complies with the requirements of BS EN 61010-1/IEC 61010-1, for Class 1 portable equipment and is for use in a pollution degree 2 environment. The equipment is designed to operate from an installation category 2 supply.			
Rated range of use	Unless otherwise indicated, specification is met over the temperature range 0 to +55°C (32 to 131°F), humidity up to 93% at +40°C (104°F) and elevation up to 3050 m (10 000 ft).			
Conditions of storage and transport	The instrument can be stored at temperatures of –40 to +71°C (-40 to 160°F), in humidities up to 93% at +40°C (104°F) and at elevations up to 4600 m (15 000 ft).			
Power requirements	90 to 132 V, or 188 to 255 V at 47 to 63 Hz, 250 VA maximum.			
Calibration interval	2 years.			
Dimensions and weight	Height	Width	Depth	Weight
	177 mm	419 mm	488 mm	16 kg
	7 in	16.5 in	19.2 in	35 lb
	(Dimensions over projections but excluding front panel handles.)			

Options

Option 1: 3-source generator

Includes three signal sources.

Option 3: High stability frequency standard

Replaces the internal TCXO with a high stability OCXO. Specification as standard instrument with the following exceptions:

Aging rate:	<±2.5 in 10 ⁷ per year, <±5 in 10 ⁹ per day after 2 months' continuous use.
Stability:	Better than ±5 in 10 ⁸ over the temperature range 0 to 50°C.
Warm-up time:	Within 2 in 10 ⁷ of final frequency 10 minutes after switch-on at a temperature of 20°C.

Option 4: Rear output connections (all inputs/outputs)

All front-panel connectors are relocated on the rear panel for rack mounted operation. The specification is not altered.

Versions, options and accessories

When ordering please quote the full ordering number information.

Ordering numbers

2026

Option 1

Option 3

Option 4

–

46882/439

54311/208

46882/295

46880/094

43129/189

46884/649

46884/650

46884/293

46884/294

46884/931

46662/614

59999/724

54112/165

Versions

10 kHz to 2.4 GHz MultiSource Generator with two signal sources.

Options

Three internal signal sources.

High-stability frequency standard.

Rear-panel outputs.

Supplied accessories

AC power supply lead (see 'Power cords', Chapter 2).

Operating manual (this document).

Optional accessories

50/75 Ω adapter.

Maintenance Manual

Service manual (consists of Operating manual (this document) plus Maintenance manual).

GPIB lead assembly, 1.5 m.

RS-232 cable, 9-way female to 25-way female, 1.5 m.

RS-232 cable, 9-way female to 9-way female, 1.5 m.

Rack-mounting kit (with slides) for rack cabinets with depths from 480 to 680 mm.

Rack-mounting kit (with slides) for rack cabinets with depths from 680 to 840 mm.

Rack-mounting kit containing front mounting brackets only.

Soft carrying case.

TEM cell.

Hard carrying case.

EC Declaration of Conformity

Certificate Ref. No.: EEA00095

The undersigned, representing:

Manufacturer: **IFR Ltd.**

Address: **Longacres House, Six Hills Way,
Stevenage, Hertfordshire, U. K. SG1 2AN**

Herewith declares that the product:

Equipment Description: 10 kHz to 2.4 GHz MultiSource Generator

Model No. 2026

Options: 1, 3, and 4

is in conformity with the following EC directive(s)
(including all applicable amendments)

Reference No.	Title:
73/23/EEC	Low Voltage Directive
89/336/EEC	EMC Directive

and that the standards and/or technical specifications referenced below have been applied:

Safety:	EMC:
IEC/EN61010-1	IEC/EN 61326-1:1997 RF Emission Class B
	Immunity Table 1 and
	Performance Criterion B

Qualifying Notes:

IFR Stevenage (Place)

4th April 2001 (Date)

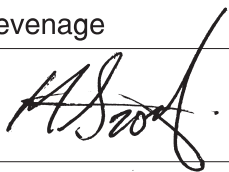

(Signature)

Mike Scott - Quality Manager

Chapter 2

INSTALLATION

Contents

Mounting arrangements	2-2
Installation requirements.....	2-2
Ventilation	2-2
Class I power cords.....	2-2
Goods-in checks.....	2-5
Connecting to supply	2-5
Fuse.....	2-5
General purpose interface bus (GPIB).....	2-5
GPIB cable connection	2-5
GPIB connector contact assignments.....	2-6
IEEE to IEC conversion.....	2-6
Interface bus connection	2-7
RS-232 interface	2-7
RS-232 connector	2-7
Auxiliary port connector	2-7
FSK operation.....	2-8
Rack mounting	2-9
Routine safety testing and inspection.....	2-9
Cleaning	2-10
Cleaning the LCD window	2-10
Putting into storage	2-10

List of tables

Table 2-1 Auxiliary port contact assignments	2-8
Table 2-2 Auxiliary port inputs for 2FSK.....	2-8
Table 2-3 Auxiliary port inputs for 4FSK.....	2-8

List of figures

Fig. 2-1 GPIB connector contact assignments (viewed from rear of instrument).....	2-6
Fig. 2-2 IEEE to IEC conversion	2-6
Fig. 2-3 RS-232 connector (viewed from rear of instrument)	2-7
Fig. 2-4 25-way AUXILIARY PORT connector.....	2-7

WARNING

Initial visual inspection

After unpacking the instrument, inspect the shipping container and its cushioning material for signs of stress or damage. If damage is identified, retain the packing material for examination by the carrier in the event that a claim is made. Examine the instrument for signs of damage; do not connect the instrument to a supply when damage is present, internal electrical damage could result in shock if the instrument is turned on.

Mounting arrangements

Excessive temperatures may affect the performance of the instrument. Completely remove the plastic cover, if one is supplied over the case, and avoid standing the instrument on or close to other equipment which is hot.

CAUTION

Installation requirements

Ventilation

This instrument is forced-air cooled by a fan mounted on the rear panel. Air must be allowed to circulate freely through the ventilator grills located on the side and underside of the instrument. Before switching on the instrument, ensure that the fan outlet on the rear panel is not restricted (i.e. clearance of at least 75 mm (3 in) at the rear, 25 mm (1 in) at each side, 15 mm (0.5 in) on the underside). Failure to provide adequate clearances will increase internal temperatures and reduce the instrument's reliability, so that its performance may not meet specification.

Class I power cords (3-core)

General

When the equipment has to be plugged into a Class II (ungrounded) 2-terminal socket outlet, the cable should either be fitted with a 3-pin Class I plug and used in conjunction with an adapter incorporating a ground wire, or be fitted with a Class II plug with an integral ground wire. The ground wire must be securely fastened to ground. Grounding one terminal on a 2-terminal socket will not provide adequate protection.

In the event that a molded plug has to be removed from a lead, it must be disposed of immediately. A plug with bare flexible cords is hazardous if engaged in a live socket outlet.

Power cords with the following terminations are available from IFR Ltd. Please check with your local sales office for availability.

This equipment is provided with a 3-wire (grounded) cordset which includes a molded IEC 320 connector for connection to the equipment. The cable must be fitted with an approved plug which, when plugged into an appropriate 3-terminal socket outlet, grounds the case of the equipment. Failure to ground the equipment may expose the operator to hazardous voltage levels. Depending upon the destination country, the color coding of the wires will differ:

Wire ended

Country	IEC 320 plug type	IFR part number
Universal	Straight through	23424-158
Universal	Right angled	23424-159

	North America	Harmonized
Line (Live)	Black	Brown
Neutral	White	Blue
Ground (Earth)	Green	Green/Yellow

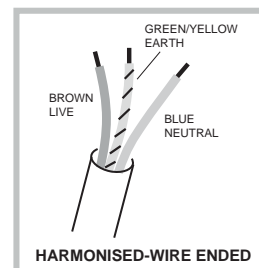

C3509

British

Country	IEC 320 plug type	IFR part number
United Kingdom	Straight through	23422-001
United Kingdom	Right angled	23422-002

The UK lead is fitted with an ASTA approved molded plug to BS 1363. A replaceable 13 A fuse to BS 1362 is contained within the plug. This fuse is only designed to protect the lead assembly. Never use the plug with the detachable fuse cover omitted or if the cover is damaged.

The fuse(s) or circuit breaker to protect the equipment is fitted at the back of the equipment.

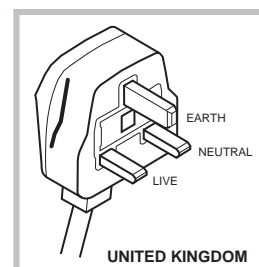

C3510

North American

Country	IEC 320 plug type	IFR part number
North American	Straight through	23422-004
North American	Right angled	23422-005

The North American lead is fitted with a NEMA 5-15P (Canadian CS22.2 No 42) plug and carries approvals from UL and CSA for use in the USA and Canada.

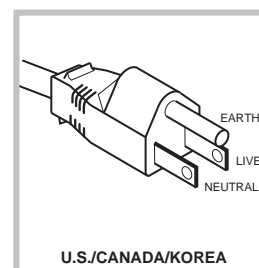

C3511

Continental Europe

Country	IEC 320 plug type	IFR part number
Europe	Straight through	23422-006
Europe	Right angled	23422-007

The Continental European lead is fitted with a right angle IEC83 standard C4 plug (CEE 7/7) which allows it to be used in sockets with either a male earth pin (standard C 3b) or side earth clips (standard C 2b) the latter is commonly called the German 'Schuko' plug. In common with other Schuko style plugs, the plug is not polarized when fitted into a Schuko socket. The lead carries approvals for use in Austria, Belgium, Finland, France, Germany, Holland, Italy, Norway and Sweden. Note that this plug will not fit Italian standard CEI 23-16 outlets. The lead should not be used in Denmark given that the earth connection will not be made.

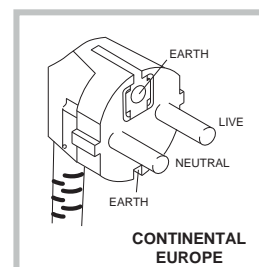

C3512

Français

Le câble d'alimentation d'Europe Continentale est muni d'un connecteur mâle à angle droit type CEI83, standard C4 (CEE 7/7), qui peut être utilisé dans une prise femelle à ergot de terre (standard C 3b) ou à clips latéraux (standard C 2b), cette dernière étant communément appelée prise "Schuko" allemande. De la même façon que les autres connecteurs de type Schuko, celui-ci n'est pas polarisé lorsqu'il s'adapte à une prise femelle Schuko. Ce câble d'alimentation est homologué en Allemagne, Autriche, Belgique, Finlande, France, Hollande, Italie, Norvège et Suède. A noter que ce connecteur n'est pas compatible avec les prises de courant italiennes au standard CEI 23-16. Ce câble ne doit pas être utilisé au Danemark à cause du défaut de connexion de masse.

Deutsch

Das kontinentaleuropäische Netzkabel ist mit einem rechtwinkligen Stecker nach IEC83 C4 (CEE7/7) Standard versehen, welcher sowohl in Steckdosen mit Erde-Stift (Standard C 3b) oder seitlichen Erdeklemmen, im allgemeinen "Schukosteckdose" genannt, paßt. Üblicherweise ist der Schukostecker bei Verwendung in Schukosteckdosen nicht gepolt. Dieses Netzkabel besitzt Zulassung für Österreich, Belgien, Finnland, Frankreich, Deutschland, Holland, Italien, Norwegen und Schweden.

Hinweis: Dieser Schukostecker paßt nicht in die italienischen Standardsteckdosen nach CEI 23-16 Norm. Dieses Netzkabel sollte nicht in Dänemark verwendet werden, da hier keine Erdeverbindung hergestellt wird.

Español

El cable de alimentación tipo Europeo Continental dispone de una clavija C4 normalizada IEC83 (CEE 7/7) que permite su utilización tanto en bases de enchufe con toma de tierra macho (tipo C 3b) o con toma de tierra mediante contactos laterales (tipo C 2b) que, en este último caso, suele denominarse "Schuko". Al igual que cualquier otra clavija tipo Schuko, las conexiones a red no están polarizadas cuando se conectan a una base tipo Schuko. El cable lleva autorización para su uso en Austria, Bélgica, Finlandia, Francia, Alemania, Holanda, Italia, Noruega y Suecia. Observe que este cable no se adapta a la norma italiana CEI 23-16. El cable no debe utilizarse en Dinamarca en el caso de no efectuarse conexión a tierra.

Italiano

I cavi d'alimentazione per l'Europa continentale vengono forniti terminati con una spina ad angolo retto del tipo C4 secondo lo standard IEC83 (CEE 7/7) che può essere usato in prese in cui la terra può essere fornita o tramite connettore maschio (C 3b) o tramite clips laterali (C 2b), quest'ultima comunemente detta di tipo tedesca "Schuko". Questa spina, quando collegata ad una presa Schuko, non è polarizzata.

Il cavo può essere usato in Austria, Belgio, Finlandia, Francia, Germania, Olanda, Norvegia, Svezia ed Italia. E' da notare che per l'Italia questo non risponde allo standard CEI 23-16.

Questa spina non dovrebbe invece essere usata in Danimarca in quanto non realizza il collegamento di terra.

Goods-in checks

The following goods-in check verifies that the instrument is functioning correctly, but does not verify conformance to the listed specification. To verify that the instrument conforms to the specification given in Chapter 1, refer to Chapter 7, 'Acceptance testing'.

- (1) Ensure that the correct fuse is fitted (accessible from the rear panel) and connect the instrument to the supply.
- (2) Switch on and check that a display is present.
- (3) If the instrument appears to be completely dead, carry out the following:
 - Check that the mains power supply line is providing power to the instrument.
 - Check that the mains fuses have not blown.

Connecting to supply

Ensure that the AC supply is correctly connected to the POWER SUPPLY socket. For supplies in the range 90–132 V and 188–264 V the PSU automatically selects the appropriate range. There is no manual voltage range selection provided.

Fuse

For the AC voltage range of 90–264 V the fuse rating is 4 A-T (time lag). The AC fuse is a cartridge type measuring 20 mm × 5 mm.

The fuse-holder is integral with the rear-panel 3-pin supply plug. For access to change the fuse, use a screwdriver to lever out the holder.

General purpose interface bus (GPIB)

The GPIB interface built into the instrument enables the signal generators to be remotely controlled to form part of an automatic measuring system.

GPIB cable connection

Connection to other equipment which has a 24-way connector to IEEE Standard 488 is made using the rear-panel GPIB 1 socket. For this purpose, the GPIB cable assembly, available as an optional accessory, (see Chapter 1, 'Versions, options and accessories') may be used. A second socket, GPIB 2, may be fitted as an option (not yet implemented).

GPIB connector contact assignments

The contact assignments of the GPIB cable connector are as given in the table below and shown in Fig. 2-1.

Contact	Function	Contact	Function
1	Data I/O 1	13	Data/O 5
2	Data I/O 2	14	Data/O 6
3	Data I/O 3	15	Data/O 7
4	Data I/O 4	16	Data/O 8
5		17	REN
6		18	Pair with 6
7	EOI	19	Pair with 7
8	DAV	20	Pair with 8
9	NRFD	21	Pair with 9
10	NDAC	22	Pair with 10
11	IFC	23	Pair with 11
12	SRQ ATN	24	Logic ground
	Ground shield		

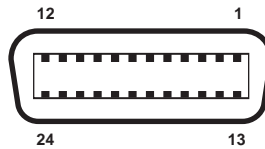
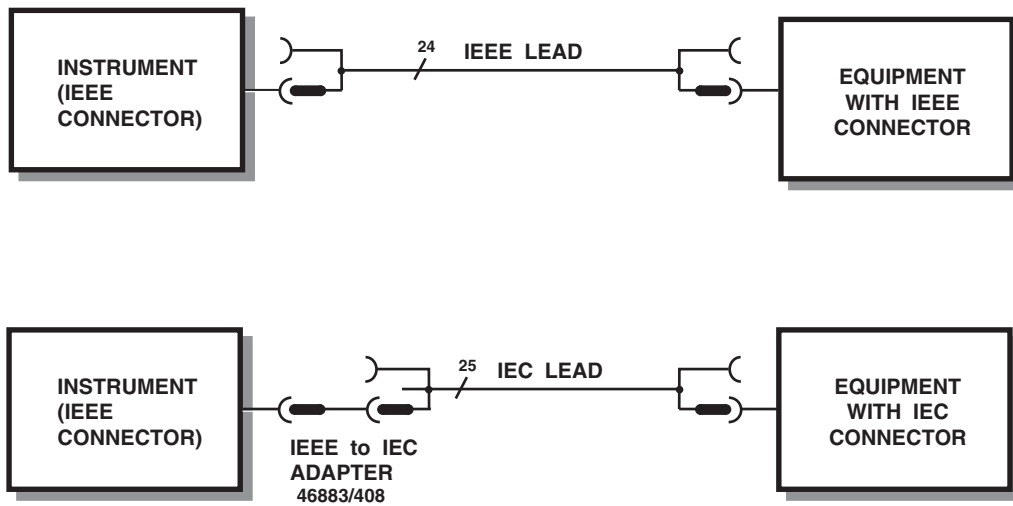

Fig. 2-1 GPIB connector contact assignments (viewed from rear of instrument)

IEEE to IEC conversion

An optional IEEE to IEC adapter is also available (contact your local distributor) for interfacing with systems using a 25-way bus connector to IEC Recommendation 625. The method of use is shown in Fig. 2-2.



C4577

Fig. 2-2 IEEE to IEC conversion

Interface bus connection

The cables for the interface bus use special male-to-female connectors at both ends. This allows several connectors to be stacked one on top of another permitting several cables to be connected to the same source and secured by a lockscrew mechanism. Too large a stack, however, may form a cantilevered structure which might cause damage and should be avoided. The piggyback arrangement permits star or linear interconnection between the devices with the restriction that the total cable length for the system must be:

- (1) No greater than 20 m (65 ft).
- (2) No greater than 2 m (6 ft) times the total number of devices (including the controller) connected to the bus.

RS-232 interface

The RS-232 interface built into the instrument is used to reprogram the internal flash memory, and may also be used to control the instrument using the common GPIB command set.

RS-232 connector

The rear-panel male D-type RS-232 connector is shown in Fig. 2-3.

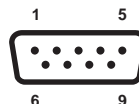

Fig. 2-3 RS-232 connector (viewed from rear of instrument)

The pin-outs for the 9-way RS-232 connector are shown below:

Contact		Signal
1	DCD	Data carrier detect
2	RXD	Receive data
3	TXD	Transmit data
4	DTR	Data terminal ready
5	SG	Signal ground
6	DSR	Data set ready
7	RTS	Request to send
8	CTS	Clear to send
9	RI	Ring indicator

The RS-232 interface can be connected to a personal computer's AT connector using a null-modem cable. A suitable cable is available from IFR – see Chapter 1, 'Versions, options and accessories'.

Auxiliary port connector

The rear-panel 25-way female D-type AUXILIARY PORT connector is shown in Fig. 2-4. This is used for FSK operation.

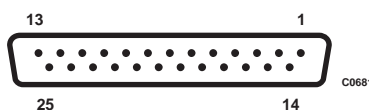

Fig. 2-4 25-way AUXILIARY PORT connector

FSK operation

Data for FSK operation is carried on the contacts of the AUXILIARY PORT as shown by Table 2-1 below. The unused contacts are left unconnected.

Table 2-1 Auxiliary port contact assignments

CONTACT	FUNCTION
14	Source A – FSK A
15	Source A – FSK B
16	Source B – FSK A
17	Source B – FSK B
18	Source C – FSK A
19	Source C – FSK B
12	0 V

The frequency shifts produced by the applied data are as shown in Table 2-2 below for 2FSK and in Table 2-3 below for 4FSK.

Table 2-2 Auxiliary port inputs for 2FSK

	FSK A	FSK B	
SOURCE A	pin 14	pin 15	SHIFT
SOURCE B	pin 16	pin 17	
SOURCE C	pin 18	pin 19	
LOGIC LEVELS	1	*0	+D
	0	*0	-D

where D is the set deviation value.

*Tie FSK B as 0 or leave floating.

Table 2-3 Auxiliary port inputs for 4FSK

	FSK A	FSK B	
SOURCE A	pin 14	pin 15	SHIFT
SOURCE B	pin 16	pin 17	
SOURCE C	pin 18	pin 19	
LOGIC LEVELS	1	0	+D
	1	1	+D/3
	0	1	-D/3
	0	0	-D

where D is the set deviation value.

Rack mounting

The instrument, which is normally supplied for bench mounting, may be mounted in a standard 19 inch rack (see Chapter 1, 'Versions, options and accessories'). There are two slide rack mounting kits to accommodate different depths of cabinet. These kits include full fitting instructions. A rack mounting kit without slides is also available which contains front-panel mounting brackets only.

CAUTION

Routine safety testing and inspection

In the UK the 'Electricity at Work Regulations' (1989) section 4(2) places a requirement on the users of equipment to maintain it in a safe condition. The explanatory notes call for regular inspections and tests together with a need to keep records.

The following electrical tests and inspection information is provided for guidance purposes and involves the use of voltages and currents that can cause injury. It is important that these tests are only performed by competent personnel.

Prior to carrying out any inspection and tests the equipment must be disconnected from the mains supply and all external signal connections removed. All tests should include the equipment's own supply lead, all covers must be fitted and the supply switch must be in the 'ON' position.

The recommended inspection and tests fall into three categories and should be carried out in the following sequence:

1. Visual inspection
2. Earth bonding test
3. Insulation resistance test.

1. Visual inspection

A visual inspection should be carried out on a periodic basis. This interval is dependent on the operating environment, maintenance and use, and should be assessed in accordance with guidelines issued by the Health and Safety Executive (HSE). As a guide, this equipment, when used indoors in a relatively clean environment, would be classified as 'low risk' equipment and hence should be subject to safety inspections on an annual basis. If the use of the equipment is contrary to the conditions specified, you should review the safety re-test interval.

As a guide, the visual inspection should include the following where appropriate:

Check that the equipment has been installed in accordance with the instructions provided (e.g. that ventilation is adequate, supply isolators are accessible, supply wiring is adequate and properly routed).

- The condition of the mains supply lead and supply connector(s).
- The correct rating and type of supply fuses.
- Security and condition of covers and handles.
- Check the presence and condition of all warning labels and markings and supplied safety information.
- Check the wiring in re-wireable plugs and appliance connectors.
- Check the cleanliness and condition of any ventilation fan filters.
- Check that the mains supply switch isolates the equipment from the supply.
- Check the supply indicator functions (if fitted).

If any defect is noted this should be rectified before proceeding with the following electrical tests.

2. Earth bonding tests

Earth bonding tests should be carried out using a 25 A (12 V maximum open circuit voltage) DC source. Tests should be limited to a maximum duration of 5 seconds and have a pass limit of 0.1 Ω after allowing for the resistance of the supply lead. Exceeding the test duration can cause damage to the equipment. The tests should be carried out between the supply earth and exposed

case metalwork, no attempt should be made to perform the tests on functional earths (e.g. signal carrying connector shells or screen connections) as this will result in damage to the equipment.

3. Insulation tests

A 500 V DC test should be applied between the protective earth connection and combined live and neutral supply connections with the equipment supply switch in the 'on' position. It is advisable to make the live/neutral link on the appliance tester or its connector to avoid the possibility of returning the equipment to the user with the live and neutral poles linked with an ad-hoc strap. The test voltage should be applied for 5 seconds before taking the measurement.

IFR Ltd employs reinforced insulation in the construction of its products and hence a minimum pass limit of 7 M Ω should be achieved during this test.

Where a DC power adapter is provided with the equipment, the adapter must pass the 7 M Ω test limit.

We do not recommend dielectric flash testing during routine safety tests. Most portable appliance testers use AC for the dielectric strength test which can cause damage to the supply input filter capacitors.

4. Rectification

It is recommended that the results of the above tests are recorded and checked during each repeat test. Significant differences between the previous readings and measured values should be investigated.

If any failure is detected during the above visual inspection or tests, the equipment should be disabled and the fault should be rectified by an experienced Service Engineer who is familiar with the hazards involved in carrying out such repairs.

Safety critical components should only be replaced with equivalent parts, using techniques and procedures recommended by IFR Ltd.

The above information is provided for guidance only. IFR Ltd designs and constructs its products in accordance with International Safety Standards such that in normal use they represent no hazard to the operator. IFR Ltd reserves the right to amend the above information in the course of its continuing commitment to product safety.

Cleaning

Before commencing any cleaning, switch off the instrument and disconnect it from the supply. The exterior surface of the case may be cleaned using a soft cloth moistened in water. Do not use aerosol or liquid solvent cleaners.

Cleaning the LCD window

To prevent damage to the LCD window, care should be taken not to scratch the surface during use and also when cleaning. The LCD window should be cleaned by wiping a slightly damp, soft, lint-free cloth gently over the surface.

Putting into storage

If the instrument is to be put into storage, ensure that the following conditions are maintained:

Temperature range: -40 to 70°C

Humidity: Less than 93% at 40°C

Chapter 3

LOCAL OPERATION

Contents

Introduction.....	3-4
Conventions	3-4
Front-panel controls and connectors.....	3-4
Rear-panel connectors.....	3-6
First-time use.....	3-9
Switching on	3-9
Display	3-9
Selecting functions and keyboard entry	3-12
Parameter adjustment.....	3-13
Displaying shifts	3-14
Combiner summary.....	3-15
Individual source operation	3-17
Signal source selection.....	3-17
Carrier frequency selection	3-17
Carrier on/off	3-18
RF level selection.....	3-18
Choice of units.....	3-18
Reverse power protection	3-18
Modulation selection.....	3-19
Modulation modes	3-19
Mode selection.....	3-19
Sig gen screens	3-20
Internal waveform selection.....	3-21
Modulation source adjustment.....	3-21
External source coupling.....	3-22
DCFM nulling.....	3-22
Modulation ON/OFF.....	3-23
Amplitude modulation selection	3-23
Frequency modulation selection	3-24
Phase modulation selection.....	3-24
Pulse modulation selection.....	3-24
FSK selection	3-25
Sweep.....	3-27
Sweep operation.....	3-27
Sweep control	3-28
Utilities	3-31
Utility menu selection	3-31
Selection menu 1	3-31
Display adjustment (menu 1).....	3-31
Frequency standard selection (menu 1)	3-32
Carrier phase adjustment (menu 1)	3-33
RF level units selection (menu 1)	3-33
50 Ω /75 Ω impedance selection (menu 1)	3-34
Power-up options (menu 1).....	3-35
Default settings	3-35
Modulation mode selection (menu 1)	3-36
Remote control selection (menu 1)	3-37
Background error reporting (menu 1).....	3-37
Protection locking and unlocking (menu 1).....	3-38
Selection menu 2.....	3-39
Software information (menu 2).....	3-39
Hardware information (menu 2)	3-40
Patent information (menu 2)	3-40
Display blanking (menu 2).....	3-40

Latch access utility (menu 2)	3-41
Elapsed time (menu 2)	3-41
RPP trip count utility (menu 2)	3-42
Display test utility (menu 2).....	3-42
Key/knob tests (menu 2)	3-43
Calibration utility (menu 2).....	3-43
Memory	3-45
Memory stores.....	3-45
Storing data	3-46
Memory protection.....	3-46
Memory protection summary	3-46
Memory protection menu.....	3-47
Memory recall	3-47
Recalling data.....	3-48
Error messages	3-49
Error handling	3-49
Background errors:	3-49
Foreground errors:	3-49
Error message priority:	3-49
GPIB errors.....	3-49
Source-specific errors	3-50

List of tables

Table 3-1 Instrument default settings.....	3-36
Table 3-2 Background errors (500–599) in priority order.....	3-50
Table 3-3 Foreground errors (0–399)	3-51
Table 3-4 GPIB errors (400–499).....	3-53

List of figures

Fig. 3-1 2026 front panel	3-4
Fig. 3-2 2026 rear panel	3-6
Fig. 3-3 2026 Sig Gen menu in normal operation showing default display.....	3-9
Fig. 3-4 Division of the Sig Gen menu (main display) into fields	3-11
Fig. 3-5 Steps menu	3-14
Fig. 3-6 Total shift menu.....	3-15
Fig. 3-7 Combiner summary (for instrument with three sources fitted).....	3-15
Fig. 3-8 Sig Gen menu with amplitude modulation selected for the A source	3-17
Fig. 3-9 RPP tripped.....	3-18
Fig. 3-10 Modulation mode selection menu.....	3-19
Fig. 3-11 Sig Gen menu with two internal modulation channels	3-20
Fig. 3-12 Sig Gen menu with internal and external modulation sources	3-20
Fig. 3-13 Internal source waveform menu	3-21
Fig. 3-14 Modulation source phase adjustment menu.....	3-21
Fig. 3-15 External source coupling menu	3-22
Fig. 3-16 Sig Gen menu with two modulation channels	3-23
Fig. 3-17 Sig Gen menu with 4FSK selected.....	3-25
Fig. 3-18 Sweep control screen in fixed mode.....	3-27
Fig. 3-19 Carrier sweep mode menu	3-27
Fig. 3-20 Sweep control screen in sweep mode (B and C sources coupled to A source)	3-28
Fig. 3-21 Utilities selection menu 1	3-31
Fig. 3-22 Display adjustment utility.....	3-32
Fig. 3-23 Frequency standard selection menu.....	3-32
Fig. 3-24 Carrier phase adjustment utility.....	3-33
Fig. 3-25 RF level units selection menu.....	3-34
Fig. 3-26 50 ohm/75 ohm calibration menu	3-34
Fig. 3-27 Power up options menu	3-35
Fig. 3-28 Modulation mode selection menu.....	3-36
Fig. 3-29 Remote control utility.....	3-37
Fig. 3-30 Current background errors display (showing example errors)	3-38

Fig. 3-31 Lock and unlock utility (during password entry) 3-38

Fig. 3-32 Utilities selection menu 2 3-39

Fig. 3-33 Software status display 3-39

Fig. 3-34 Hardware status display 3-40

Fig. 3-35 Patent information display..... 3-40

Fig. 3-36 Display blanking utility 3-41

Fig. 3-37 Latch access utility 3-41

Fig. 3-38 Elapsed time utility..... 3-42

Fig. 3-39 RPP trip count utility..... 3-42

Fig. 3-40 Display test utility 3-42

Fig. 3-41 Keyboard/knob test utility 3-43

Fig. 3-42 Calibration menu 3-43

Fig. 3-43 Memory store menu..... 3-46

Fig. 3-44 Memory write protection summary 3-46

Fig. 3-45 Memory write protection menu 3-47

Fig. 3-46 Memory recall menu 3-48

Introduction

This chapter explains how to:

- Set up the multisource generator to produce a typical basic signal.
- Select the main operating parameters; carrier frequency, output level and type of modulation.
- Use the full range of supporting facilities.

Conventions

The following conventions are used in this chapter:

RF OUTPUT Titles marked on the instrument panel are shown in capital letters

[SETUP] Hard key titles are shown in square brackets, and

[Carrier Freq] Soft key titles are shown in italics in square brackets; for example, *[Carrier Freq]* means the soft key adjacent to the *Carrier Freq* title box at the side of the menu.

RF Level Messages appearing on the screen are shown in italic letters.

Front-panel controls and connectors

Parameters are selected by means of hard keys (which have their function printed on them), soft keys (which do not have any notation), a numerical key pad and a rotary control knob; see Fig. 3-1 below. The hard keys have functions which do not change, whereas the soft key functions are determined by the menu which is being displayed. The numerical keys are used to set parameters to specific values which can also be varied in steps of any size by using the [\downarrow][\uparrow] keys or the rotary control knob.

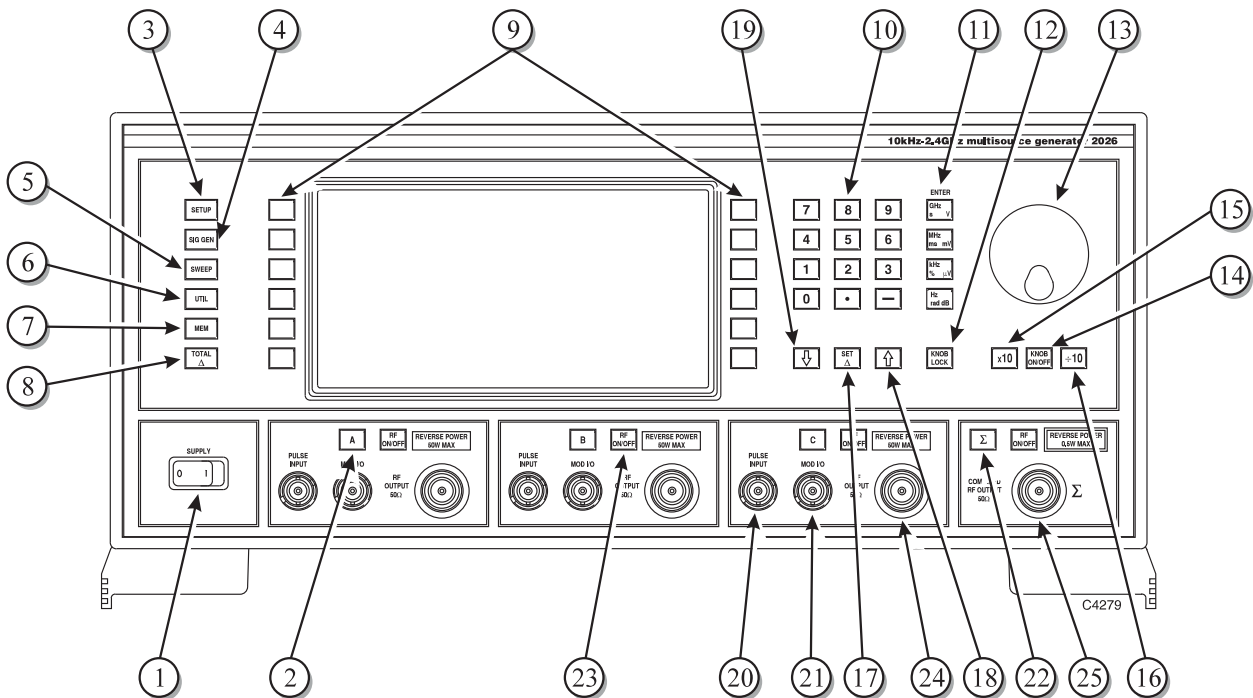

Fig. 3-1 2026 front panel

- | | | |
|---|--------------------|---|
| ① | SUPPLY | Switches the AC supply voltage on and off. |
| ② | [A], [B], [C] | This key is repeated for each signal source. It selects A, B or C as the current signal source for parameter display and adjustment. The C source is optional. |
| ③ | [SETUP] | Displays the Setup Menu used for signal source configuration and for selecting an application mode.. |
| ④ | [SIG GEN] | Displays the main, Sig Gen, menu. |
| ⑤ | [SWEEP] | Displays the Sweep Control screen for the current source. |
| ⑥ | [UTIL] | Displays the Utilities Selection Menu. |
| ⑦ | [MEM] | Displays the Memory Store/Recall Menu. |
| ⑧ | [TOTAL Δ] | Displays the Total Shift Menu for the current source. |
| ⑨ | Soft keys | Twelve function keys change notation as the menus change. |
| ⑩ | Numerical key pad | For entering the value of a selected parameter. Minus sign and decimal point are included. |
| ⑪ | [ENTER]/Units keys | Determine the units of the set parameters and also used to terminate a numerical entry. |
| ⑫ | [KNOB LOCK] | Pressing this key assigns control knob operation to the currently selected function. |
| ⑬ | Control knob | When enabled by the [KNOB ON/OFF] key, adjusts the value of the selected parameter. |
| ⑭ | [KNOB ON/OFF] | Enables or disables the control knob. |
| ⑮ | [×10] | When control knob enabled, decreases knob resolution by a factor of 10. |
| ⑯ | [÷10] | When control knob enabled, increases knob resolution by a factor of 10. |
| ⑰ | [SET Δ] | Displays the Steps Menu for the current source. |
| ⑱ | [↑] | Increments the value of the selected parameter. |
| ⑲ | [↓] | Decrements the value of the selected parameter. |
| ⑳ | PULSE INPUT | 10 kΩ BNC connector (fitted to each signal source) which accepts a pulsed input. |
| ㉑ | MOD I/O | 100 kΩ BNC connector (fitted to each signal source) which allows an external modulating signal to be applied. Also provides a modulation oscillator output from a 600 Ω source impedance. With Option 4 this connector is fitted on the rear panel. |
| ㉒ | [Σ] | Displays the Combiner Summary. |
| ㉓ | [RF ON/OFF] | Enables or disables the associated signal source RF OUTPUT or the COMBINED RF OUTPUT connector. |
| ㉔ | RF OUTPUT | 50 Ω type-N connector (fitted to each signal source). Protected against the application of reverse power of up to 50 W. With Option 4 this connector is fitted on the rear panel. |
| ㉕ | COMBINED RF OUTPUT | 50 Ω type-N connector. Note that maximum reverse power at this connector is 0.5 W. With Option 4 this connector is fitted on the rear panel. |

Rear-panel connectors

The rear-panel connectors are shown in Fig. 3-2 below.

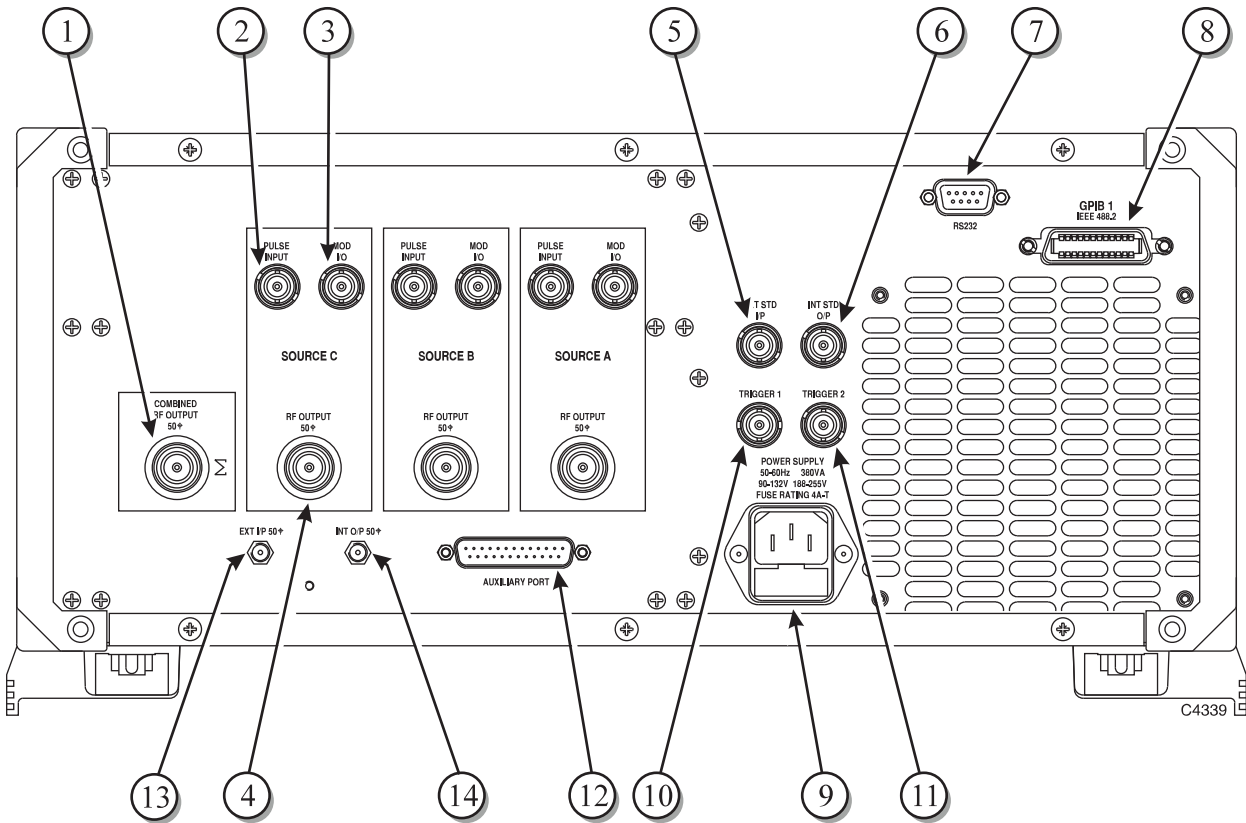

Fig. 3-2 2026 rear panel

- | | |
|---|---|
| <p>① COMBINED RF OUTPUT (optional)</p> <p>② PULSE INPUT (optional)</p> <p>③ MOD I/O (optional)</p> <p>④ RF OUTPUT (optional)</p> <p>⑤ EXT STD I/P</p> <p>⑥ INT STD O/P</p> <p>⑦ RS232</p> <p>⑧ GPIB 1</p> <p>⑨ POWER SUPPLY</p> <p>⑩ TRIGGER 1</p> <p>⑪ TRIGGER 2</p> | <p>An Option 4 50 Ω type-N connector. When fitted, replaces the front-panel connector.</p> <p>An Option 4 10 kΩ BNC connector. When fitted, replaces the front-panel connector.</p> <p>An Option 4 100 kΩ BNC connector. When fitted, replaces the front-panel connector.</p> <p>An Option 4 50 Ω type-N connector. When fitted, replaces the front-panel connector.</p> <p>BNC connector for the input of an external standard frequency of either 1 MHz or 10 MHz.</p> <p>BNC connector for the output of the internal 10 MHz standard.</p> <p>9-way RS-232 connector used for remote control of the instrument as well as to reprogram the internal flash memory. For contact allocation see ‘RS-232 connector’ in Chapter 2.</p> <p>24-pin socket accepts standard IEEE connector to allow remote control of the instrument.</p> <p>3-pin plug integral with fuse holder. Mates with AC supply lead socket.</p> <p>BNC connector which is used for sweep triggering.</p> <p>Reserved.</p> |
|---|---|

- ⑫ **AUXILIARY PORT** 25-pin socket. Can accept external data to modulate each of the internal sources for 2-level or 4-level FSK. For contact allocation see 'Auxiliary port connector' in Chapter 2.
- ⑬ **EXT I/P** 50 Ω SMA connector. Enables a signal to be fed into the combiner from an external signal generator.
- ⑭ **INT O/P (optional)** 50 Ω SMA connector. Used when a third source is fitted to provide a rear-panel output. When linked to the EXT I/P socket, connects the C source output to the combiner. When this socket is not in use it must be terminated by the attached 50 Ω load to prevent signal radiation from the C source.

First-time use

First-time users can quickly become familiar with the principles of control and display by carrying out the following exercise, which demonstrates how to set up a typical basic signal, having the following parameters, on one of the signal sources:

Carrier frequency: 100 MHz,
Output level: 10 dBm,
Frequency modulation: 100 kHz deviation at 500 Hz mod.

Switching on

Before switching the instrument on, check that the power supply is connected and ensure that no external signal sources are connected.

Switch on by means of the SUPPLY switch and check that the display is similar to that shown in Fig. 3-3 below. This shows the Sig Gen menu as it appears during normal operation.

If the default display shown in Fig. 3-3 is not obtained, a previous user may have set the instrument to switch on with one of the user memories recalled, rather than using the default factory settings.

To reset to the factory settings press the [UTIL] hard key followed by the soft key sequence [Power Up Options] [Factory Power Up] [EXIT]. Then switch off and switch back on again.

Observe that the Sig Gen menu appears on the display showing the default parameters for FM, and that the panel for the A signal source is highlighted at the bottom left of the screen. This indicates that these parameters apply only to the A source.

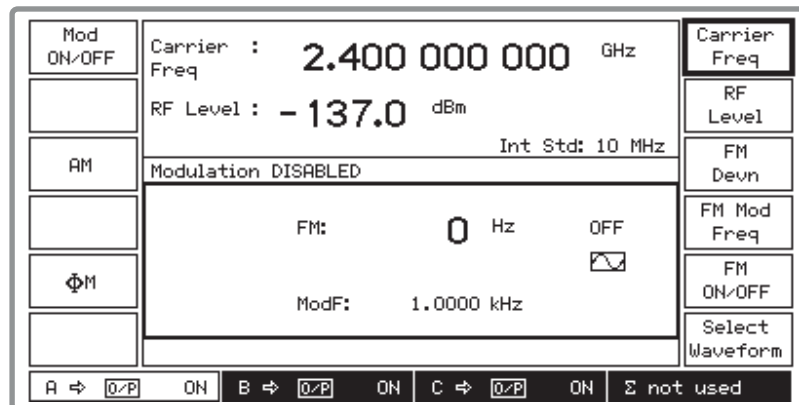

Fig. 3-3 2026 Sig Gen menu in normal operation showing default display

Display

Before entering any parameters it will be found useful to look at the effect that pressing various keys has on the display for the Sig Gen menu. This is the main display and it is divided into a number of fields as shown in Fig. 3-4 below.

Signal source field

This field, at the bottom of the display, is divided into four panels, one for each of the three signal sources and one for the combiner. When a source panel is highlighted, all the parameters shown

on the screen apply to that source; for example, when the A panel is highlighted, the displayed carrier frequency, RF level, modulation etc., apply only to the A source. The selected signal source can be changed using the [A], [B] and [C] hard keys.

The RF output from a source may be directed to its own output socket, or re-routed via the combiner (either alone or in combination with other sources) to the combiner output socket. Signal sources are combined using a menu accessed via the [SETUP] hard key.

The designation $A \Rightarrow O/P$ shows that the A source output is directed to the RF OUTPUT socket for the A source. When $A \Rightarrow \Sigma$ is displayed it shows that the A source output is directed to the combiner.

When no signal source is connected to the combiner the combiner panel shows Σ *not used*. When appropriate *not fitted* is shown against source designator C.

When one or more sources are connected via the combiner to the COMBINED RF OUTPUT socket, the combiner panel displays this information by showing all combinations from $\Sigma = A$ to $\Sigma = A+B+C$.

Note that the signal source field is displayed in all modes.

Carrier frequency field

This shows the current carrier frequency setting for the selected signal source. This field is controlled by the [*Carrier Freq*] soft key.

When the frequency of the selected source is coupled to another source (so that it tracks it), an arrow is shown together with the other source's identity. In Fig. 3-4 for example, the B source is shown coupled to the A source by the A source panel being highlighted and $\Rightarrow B$ being shown in the carrier frequency field.

RF level field

This shows the current RF level setting for the selected signal source. This field is controlled by the [*RF Level*] soft key.

When the level of the selected source is coupled to another source, an arrow is shown together with the other source's identity (as for frequency coupling).

Frequency standard field

The type of standard is shown in this field together with its frequency. Frequency standard selection is made from a menu accessed via the [UTIL] hard key.

This field also displays *Atten Lock* when the attenuator lock function is enabled.

Modulation state field

Here the modulation state is shown as either *ENABLED* or *DISABLED*. This is controlled by the [*Mod ON/OFF*] key which switches all internal modulation on or off.

When pulse modulation is selected, *Pulse ON* or *OFF* is shown (an additional soft key [*Pulse ON/OFF*] also appears).

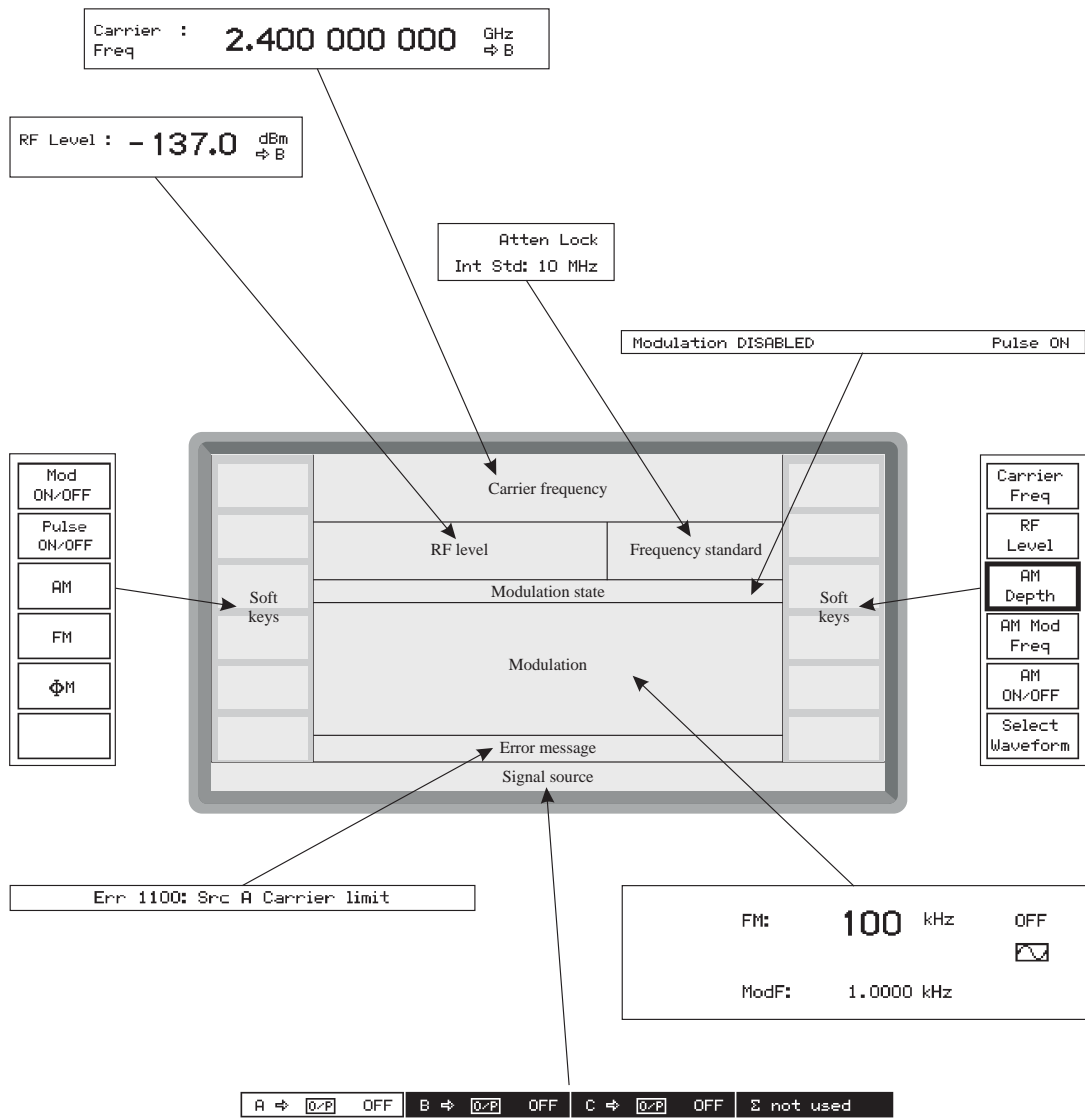

C3290

Fig. 3-4 Division of the Sig Gen menu (main display) into fields

Modulation field

This field shows all the current modulation settings for the selected signal source: type of modulation; modulation deviation/depth; modulation frequency; waveform type (shown graphically); modulation ON or OFF.

The type of modulation is selected by the [FM], [AM] and [ϕM] keys. Only two of the three keys are shown at any time. This is because the display will already be showing the parameters for the omitted selection key.

Modulation deviation/depth is selected by the [FM Devn], [AM Depth] and [ϕM Devn] keys.

Modulation frequency is selected using the [FM Mod Freq], [AM Mod Freq] and [ϕM Mod Freq] keys and the value is shown on the screen against ModF:.

The type of waveform (sine, triangle or square) is obtained from a menu after pressing the [Select Waveform] key. For external modulation this key is replaced by the [Select Coupling] key.

Internal modulation switching is controlled by the [FM ON/OFF], [AM ON/OFF] and [ϕM ON/OFF] keys.

Error message field

Error messages are displayed here when, for example, you exceed a parameter limit. A list of error messages is given at the end of this chapter.

Soft key fields

These fields can hold up to 12 soft key labels. Some soft keys are used to select a field for data entry (e.g. [*Carrier Freq*]), in which case the soft key label will remain highlighted after being pressed to show that any subsequent data entry applies to that function.

Other soft keys may perform an action (for example, turning the modulation on or off), in which case the label will flash to acknowledge the key-press.

Some soft keys cause another menu to be displayed, in which case there is no highlighting or flashing of the label, the change of menu acknowledges the key-press.

Selecting functions and keyboard entry

Whenever one of the main functions – carrier frequency, RF level, modulation – is highlighted on the main screen, making any terminated numerical entry will be accepted as being a changed parameter for that function. This enables you to enter, for example, a sequence of carrier frequencies without having to re-press the [*Carrier Freq*] key for each entry.

First of all, select the A source for adjustment by pressing the [A] key.

Carrier frequency

- (1) Press the [*Carrier Freq*] soft key to select carrier frequency as the current function. The key label is highlighted so that the line bordering the label is increased in thickness to about 1 mm. Data entered on the key pad will now be recognized as a frequency setting and replaces the current setting.
- (2) Enter 100 MHz by entering 100 on the numerical key pad and terminating with [MHz]. Observe that the *Carrier Freq*: display changes to *100.000 000 MHz*.

If you make an error when keying in, press the function key again and key in the correct value. If this causes an error message (e.g. *Err 1100: Carrier Limit*) to be displayed, it can be canceled by a correct entry (e.g. by entering a value which is within limits).

RF level

- (3) Press [*RF LEVEL*] (which causes its key label to be highlighted) to select RF level as the current function.
- (4) Enter 10 dBm by entering 10 on the numerical key pad and terminating with [dB]. Observe that the *RF Level*: display changes to *+10.0 dBm*.
- (5) Press the [RF ON/OFF] key for the A signal source. Repeated pressing toggles between the on and off states as shown by *A* ⇌ *O/P ON* and *OFF* in the A source panel. Select *ON*. A 100 MHz, 10 dBm carrier is now being generated from the A source RF OUTPUT socket.

Modulation

- (6) Press [*FM Devn*]. Enter 100 on the key pad and terminate with [kHz]. *100 kHz* is displayed in the modulation field.
- (7) Press [*FM Mod Freq*]. Enter 500 on the key pad and terminate with [Hz]. *ModF: 500.00 Hz* is displayed.
- (8) Press [*Mod ON/OFF*]. Repeated pressing toggles between the on and off states as shown by *Modulation ENABLED* and *DISABLED* at the centre of the screen. Select *Modulation ENABLED*.
- (9) Press [*FM ON/OFF*]. Repeated pressing toggles between the on and off states as shown by *ON* and *OFF* on the screen. Select *ON*. A 100 MHz, 10 dBm carrier is now being generated

at 100 kHz deviation, sine wave modulated at 500 Hz from the A source RF OUTPUT socket.

Parameter adjustment

When a function has been selected, you can increment or decrement its parameter either continuously using the control knob or in steps using the [↑] and [↓] keys. You can also simultaneously adjust two parameters by means of the [KNOB LOCK] key.

Using the control knob

You enable the control knob by pressing the [KNOB ON/OFF] key so that the parameter to be adjusted is displayed outlined by a bracket. With the control knob enabled, you can set its resolution. Press the [+10] key to increase the bracket length by one decimal place. Similarly, press the [×10] key to decrease the bracket length by one decimal place. In this way you respectively increase or decrease the resolution of the control knob by a factor of ten.

Disabling the control knob will help to ensure that accidental changes to the set parameters are prevented.

Two-parameter adjustment

A feature of this instrument is that the [KNOB LOCK] key enables you to simultaneously and independently adjust two parameters using the control knob and the [↑] [↓] keys. Proceed as follows:

- (1) Select the function to be assigned to the control knob for adjustment by pressing its soft key; for example, [*Carrier Freq*]. When selected, the soft key is highlighted so that the line bordering the key label is increased in thickness to about 1 mm.
- (2) Enable the control knob using the [KNOB ON/OFF] key (so that the bracket is visible above and below the parameter).
- (3) Press the [KNOB LOCK] key. Now any movement of the control knob will only adjust the parameter of the assigned function leaving you free to select a second function – for example [*RF Level*] – and adjust its parameter this time using the [↑] and [↓] keys. At all times the function locked to the control knob is identified by its parameter being outlined by a bracket and an inverse-video bracket symbol being displayed at the lower right of the screen.

Using the steps keys

The selected function's parameter may be adjusted in steps using the [↑] and [↓] keys to respectively increment and decrement the parameter. The step size can be set as follows:

- (1) Press the [SET Δ] key which causes the *Steps Menu* to be displayed (see Fig. 3-5 below). This shows the step sizes of the currently selected signal source.

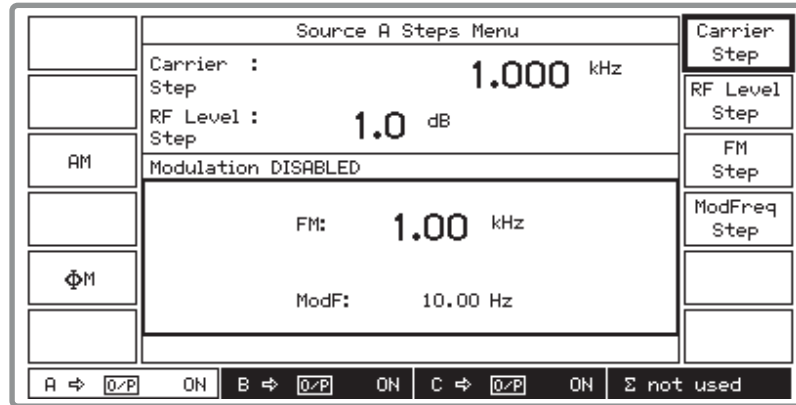

B3421

Fig. 3-5 Steps menu

- (2) Select [Carrier Step], enter the value on the key pad and press a terminator key. The step value will appear on the screen.
- (3) Return to the Sig Gen menu by pressing [SIG GEN].
- (4) Using the [↑] and [↓] keys respectively will now increment or decrement the carrier frequency by the set value.
- (5) [RF Level Step], [ModFreq Step] and [FM Step], [AM Step] and [φM Step] values can be entered in the same way.
- (6) Repeat as required for the other signal sources.

Displaying shifts

You can check the difference between the keyed-in value (the reference) and the current value, as well as restoring the reference either to the original value or resetting it to the new value. Proceed as follows:

- (1) Press [TOTAL Δ] to display the *Total Shift Menu* for the selected signal source. This displays the amount of shift from the reference caused by using the control knob or [↓] [↑] keys to adjust the parameters (see Fig. 3-6 below).

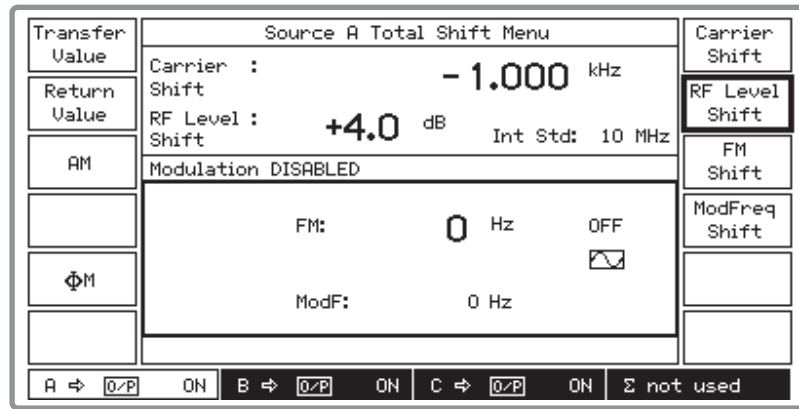

B3422

Fig. 3-6 Total shift menu

- (2) Carrier frequency and RF level, as well as modulation depth/deviation and frequency – in combination with the [AM], [FM] and [ϕ M] keys – can be further adjusted using the appropriate [Shift] key. The amount of shift at each key-press is that of the current step value.

Combiner summary

The [Σ] hard key may be used to display a summary of all the sources' frequencies and levels and provides an easy means to change these parameters. This menu is also used to implement the attenuator lock function for each individual source. The function inhibits operation of the step attenuator from the level at which the key is enabled, and is usable for a level reduction of at least 10 dB.

- (1) Press the [Σ] hard key to show the *Combiner Summary* similar to that shown in Fig. 3-7 below.

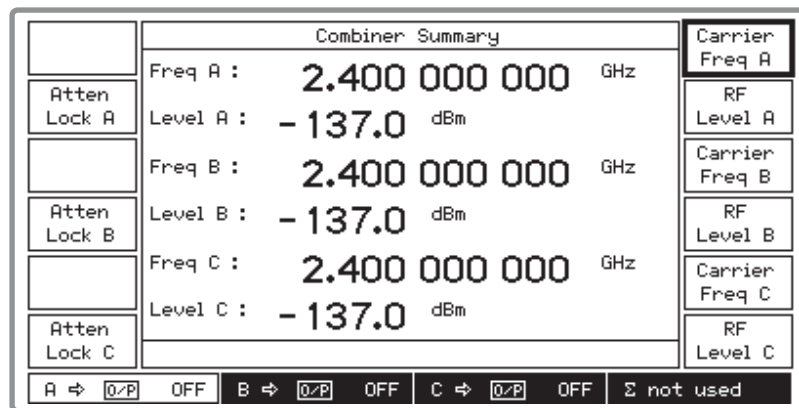

B3423

Fig. 3-7 Combiner summary (for instrument with three sources fitted)

- (2) You can reset the carrier frequencies and RF levels for each of the sources fitted in your instrument. Press the [Carrier Freq] or [RF Level] key for the applicable source, enter the new value on the key pad and press a terminator key.
- (3) To display the individual signal source settings press the required [A], [B] or [C] key.
- (4) To implement the attenuator lock function, press the [Atten Lock] key for the required A, B or C source. *Atten Lock* is shown on the menu (and also shown on the Sig Gen menu) against the appropriate source parameters.

Individual source operation

The following section describes the method of controlling the settings of the individual signal sources. The method of control can be used irrespective of the routing of the signal source output, whether to its own RF OUTPUT or to the COMBINED RF OUTPUT, and irrespective of any coupling that may have been set up.

Signal source selection

Select the required signal source by pressing the [A], [B] or [C] key. The selection is acknowledged by the A, B or C panel at the bottom of the display being highlighted. Having entered the parameters for that signal source you can then repeat the procedure for each additional source. In Fig. 3-8 below the parameters for the A source are shown.

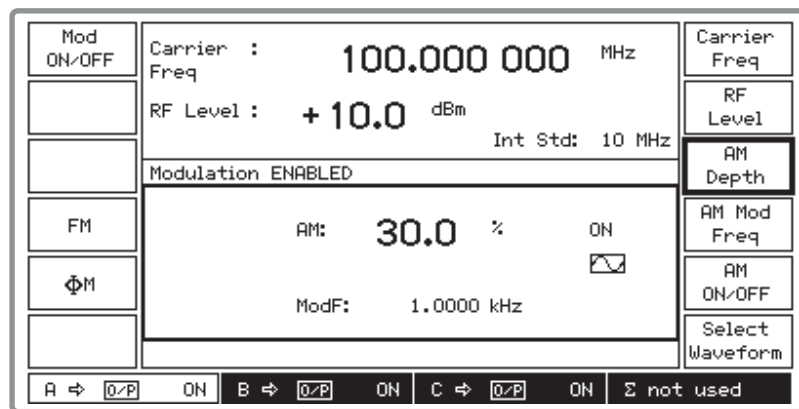

B3424

Fig. 3-8 Sig Gen menu with amplitude modulation selected for the A source

Carrier frequency selection

You can enter the carrier frequency in the range 10 kHz to 2.4 GHz to a resolution of 1 Hz.

- (1) Press [SIG GEN] to show the Sig Gen menu with the current carrier frequency displayed.
- (2) Press the [Carrier Freq] soft key to select carrier frequency as the current function.
- (3) Enter the required value using the numerical key pad. Terminate using the [Hz], [kHz], [MHz] or [GHz] key. If a value outside the specified range is requested, an error message is displayed and the instrument is automatically set to the end of the range.
- (4) You can then adjust the frequency either in steps using the [↓],[↑] keys or by using the control knob for continuous adjustment. The default increment/decrement is 1 kHz.
- (5) You can check the current amount of offset from the reference carrier frequency by pressing [TOTAL Δ]. This causes the *Total Shift Menu* to be displayed.
- (6) On the *Total Shift Menu* pressing the [Return Value] key returns you to the reference carrier frequency; pressing [Transfer Value] selects the currently displayed frequency as the reference frequency.
- (7) Pressing [SIG GEN] returns you to the Sig Gen menu.

Carrier on/off

The carrier can be switched on or off at any time by means of the [RF ON/OFF] key. This effectively switches the output on and off, retaining the 50 Ω output impedance.

RF level selection

You can enter the RF level in the range -137 to +24 dBm (to +20 dBm above 1.2 GHz).

- (1) Press [SIG GEN] to show the Sig Gen menu with the current RF level displayed.
- (2) Press the [RF Level] soft key to select RF level as the current function.
- (3) Enter the required value using the numerical key pad. For voltage terminate using the [μV], [mV] or [V] key. For logarithmic units terminate using the [dB] key. RF levels in linear and logarithmic units are selected from the utilities (see 'Choice of units' below). If a value outside the specified range is requested, an error message is displayed and the instrument is automatically set to the end of the range.
- (4) You can then adjust the level either in steps using the [↓],[↑] keys or by using the control knob for continuous adjustment. The default increment/decrement is 1 dB.
- (5) You can check the current amount of offset from the reference level by pressing [TOTAL Δ]. This causes the *Total Shift Menu* to be displayed.
- (6) Pressing [Return Value] returns you to the reference level; pressing [Transfer Value] selects the currently displayed level as the reference level.
- (7) Pressing [SIG GEN] returns you to the Sig Gen menu.

Choice of units

Units may be μV, mV, V or dB. Conversion between dB and the voltage units is carried out by pressing the appropriate units key; for example, to change dBm to a voltage unit, press any voltage key for the correct conversion. The choice of Volts EMF, Volts PD and the dB reference is made by using the *RF Level Units Selection Menu*.

Reverse power protection

Accidental application of power to an individual signal source's RF OUTPUT socket trips the reverse power protection circuit (RPP) and a menu similar to that shown in Fig. 3-9 below appears with a flashing message.

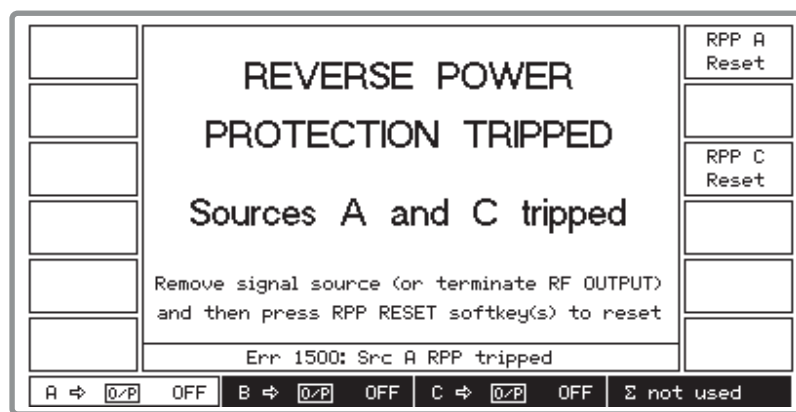

B3473

Fig. 3-9 RPP tripped

Note that the protection circuit may be activated when a source is set to a high level and its RF OUTPUT socket has no terminating load.

The protection circuit can be reset by pressing the *[RPP Reset]* key for the appropriate source after having either removed the signal to the source or terminated the RF OUTPUT socket. The display then returns to the menu in use at the time that the RPP was tripped. If *[RPP Reset]* is pressed with the signal still applied, the RPP will trip again.

CAUTION The maximum reverse power at the COMBINED RF OUTPUT socket is 0.5 W.

Modulation selection

The carrier from each signal source can be amplitude, frequency or phase modulated from an internal or external source. Additionally pulse modulation is available from an external source. The internal modulation oscillator is capable of generating two tones simultaneously in one modulation channel and has a frequency range of 0.01 Hz to 20 kHz.

Modulation modes

Each signal source has its own independent modulation facilities. The MOD I/O socket on each of the signal sources allows an external modulation signal to be summed with the signals from the internal oscillator. This allows up to three modulations to be available from each source; for example, external FM with a combined internal AM1 and AM2.

Modulation source can be internal or external. If internal, the modulation can be the sum of two signals – AM1 + AM2, FM1 + FM2 or ϕ M1 + ϕ M2 – each of which can have its own depth/deviation and modulation frequency.

The common carrier wave can be modulated by two different types of modulation, where one uses an internal source and the other an external source. The internal source may be composed of two signals. Allowed combinations are:

- internal AM + external FM ; internal FM + external AM
- internal AM + external ϕ M ; internal ϕ M + external AM

Note that pulse modulation may be selected for each signal source in addition to any normal modulation combination.

Mode selection

Modulation mode is selected as follows:

- (1) Press the *[UTIL]* hard key to display the *Utilities Selection Menu 1* (additionally pressing *[Utils Menu 1]* if necessary). Then select *[Mod'n Mode]* to display the *Modulation Mode Selection Menu*. This shows the currently selected modulation mode (see Fig. 3-9 below) for the selected signal source.

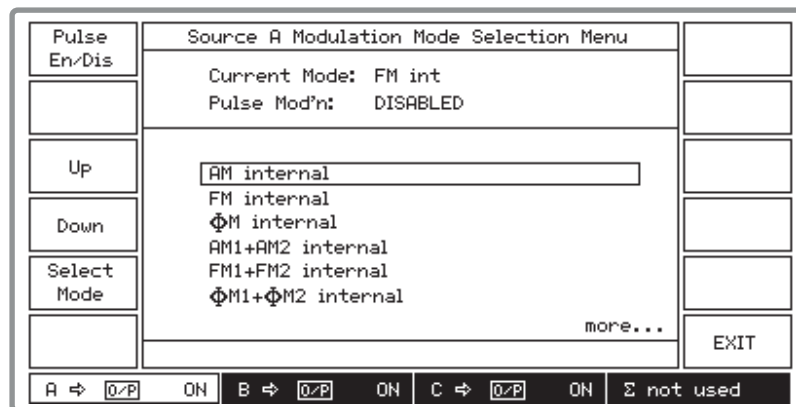

B3460

Fig. 3-10 Modulation mode selection menu

- (2) Use the [Up] and [Down] keys to move the selection box over the required modulation mode. Repeated pressing of the [Down] key will cause the screen to scroll, revealing further selections.
- (3) Press [Select Mode]. The display changes to show your new current modulation mode.
- (4) Press [SIG GEN] to display the Sig Gen menu which has been modified to show the new configuration.

Sig gen screens

Changing the modulation mode by means of the *Modulation Mode Selection Menu* affects the way in which the Sig Gen screen is presented as follows:

If a single internal modulation mode – for example, *AM internal* – has been selected, the [Select Waveform] key is displayed. This is replaced by the [Select Coupling] key if instead, a single external modulation mode – for example, *FM external* – has been selected.

If a dual internal modulation mode – for example, *AM1 + AM2 internal* – has been selected, the modulation field is divided vertically into two panels, one for each modulation channel as shown in Fig. 3-11 below.

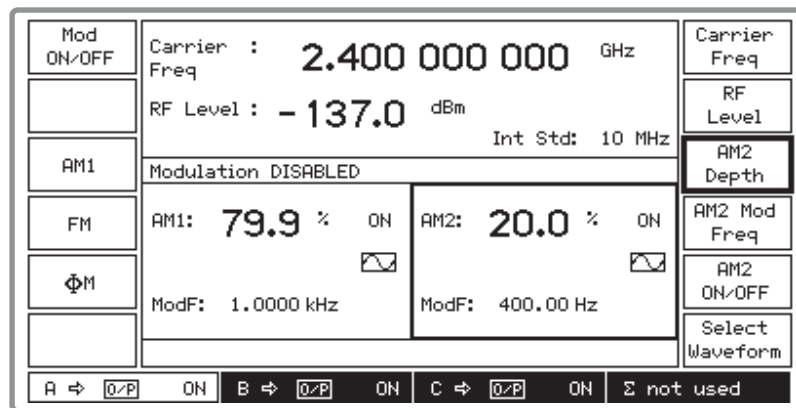

B3425

Fig. 3-11 Sig Gen menu with two internal modulation channels

If a dual mixed modulation mode – for example, *AM1 internal & FM external* – has been selected, the modulation field is divided horizontally into two panels, one for each modulation source as shown in Fig. 3-12 below.

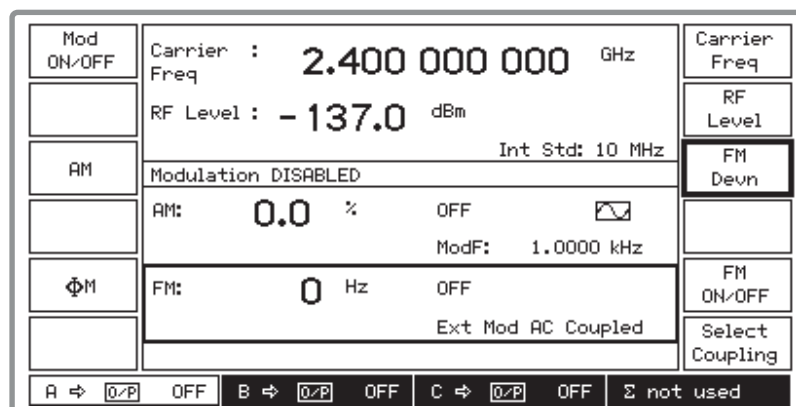

B3461

Fig. 3-12 Sig Gen menu with internal and external modulation sources

Internal waveform selection

Having selected an internal modulation mode, you can select the type of waveform as follows:

- (1) Press [SIG GEN] to show the Sig Gen menu.
- (2) Press [Select Waveform] to display the *Internal Source Waveform Menu*. This shows the currently selected modulation and waveform (see Fig. 3-13 below).

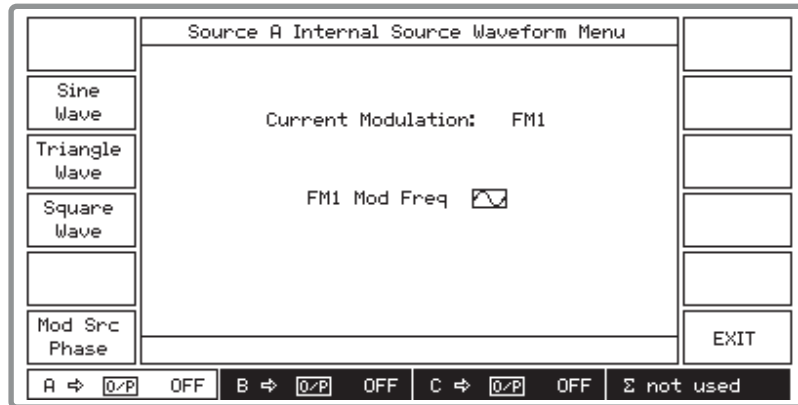

B3419

Fig. 3-13 Internal source waveform menu

- (3) Select between [Sine Wave], [Triangle Wave] and [Square Wave]. The waveform on the screen changes to show your new waveform selection.
- (4) Press [EXIT] to return to the Sig Gen menu.

Modulation source adjustment

You can adjust the phase difference of modulation oscillator channel 2 relative to channel 1 in degrees as follows:

- (5) Press the [Mod Src Phase] key to display the *Modulation Source Phase Adjustment* menu shown in Fig. 3-14 below. This shows the currently selected phase difference setting for the selected signal source.

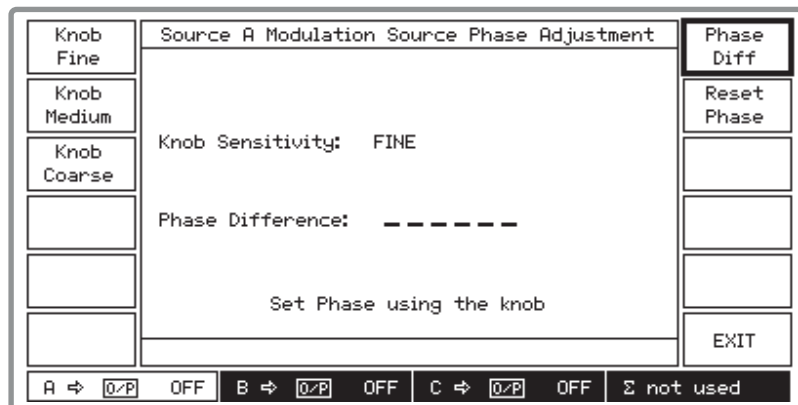

B3418

Fig. 3-14 Modulation source phase adjustment menu

- (6) Select the required adjustment control by pressing [Knob Fine], [Knob Medium] or [Knob Coarse]. These provide adjustments in steps of 0.1°, 1.0° and 3.0° respectively.

- (7) Press [*Phase Diff*] and adjust the phase using the control knob. Turn clockwise to advance the phase and anticlockwise to retard the phase. Note that if you have set the source phase and subsequently adjusted the source frequency or changed the waveform, the menu *Phase Difference*: value will be blanked. This is because the value will then be indeterminate due to the adjustment or changed waveform.
- (8) To establish a reference, the displayed phase shift can be reset to 0.0° by pressing [*Reset Phase*].
- (9) Press [*EXIT*] to return to the Sig Gen menu.

External source coupling

Having selected an external modulation mode, you can select the type of external coupling as follows:

- (1) Press [SIG GEN] and show the Sig Gen menu for a single modulation mode.
- (2) Press [*Select Coupling*] to display the *External Source Coupling Menu*. This shows the currently selected modulation and external coupling (see Fig. 3-15 below). The [DCFM Nulling] key appears only during FM external modulation mode with DC coupling.

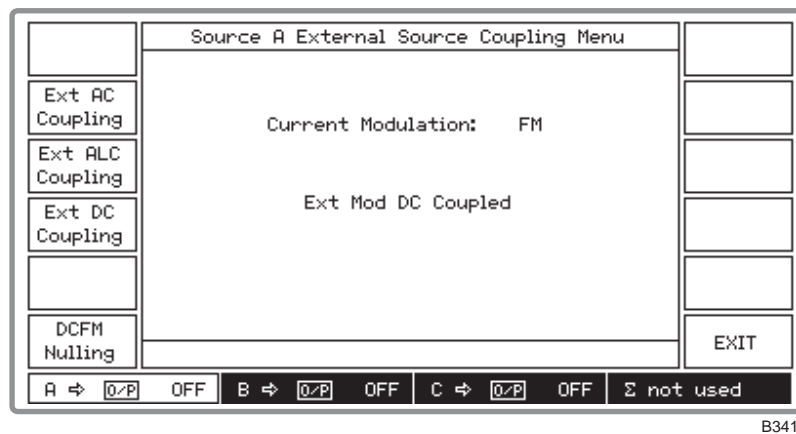

Fig. 3-15 External source coupling menu

- (3) Select between [*Ext AC Coupling*], [*Ext ALC Coupling*] and [*Ext DC Coupling*]. The screen changes to show your new coupling selection.
- (4) Apply a signal to the MOD I/O socket.
- (5) When Automatic Levelling Control is selected by pressing [*Ext ALC Coupling*], and the error message *Err 511: ALC too high* or *Err:512: ALC too low* is displayed, the level must be adjusted. Adjust the signal level until it is within the 0.75 to 1.25 V RMS ALC range of the source.
- (6) Press [*EXIT*] to return to the Sig Gen menu.

DCFM nulling

For a DC-coupled external signal, small frequency offsets can be reduced by using the DCFM nulling facility. Operation is as follows:

- (1) With *FM External* mode previously selected from the *Modulation Mode Selection Menu* press the [*Ext DC Coupling*] key shown in Fig. 3-15 above.
- (2) Connect your ground reference to the MOD I/O socket.
- (3) Press the [*DCFM Nulling*] key which is now displayed. **DCFM Nulling** appears during the nulling process and when it disappears the process is completed.

Modulation ON/OFF

[Mod ON/OFF] switches all modulation ON or OFF and the condition is indicated in the centre of the Sig Gen menu:

Modulation DISABLED

Modulation is also controlled by the individual modulation ON/OFF keys. For modulation to appear on the carrier, modulation must be both enabled with the [Mod ON/OFF] key and the individual [AM ON/OFF], [FM ON/OFF], [ϕ M ON/OFF] and [Pulse ON/OFF] keys. The individual modulation ON/OFF keys only reduce the modulation to zero, whereas the [Mod ON/OFF] key completely disables the modulation system so that the instrument reverts to a carrier frequency generator.

Amplitude modulation selection

Select amplitude modulation as follows:

- (1) Press [SIG GEN] to show the Sig Gen menu with the current modulation displayed in the bottom half of the screen.
- (2) Press the [AM] soft key if displayed (otherwise the instrument is already in the AM mode).
- (3) Press [AM Depth]. Enter the modulation depth using the numerical key pad and terminate with any [ENTER] key. If you exceed the 99.9% modulation limit it is automatically reset to the maximum allowed value.
- (4) If the internal modulation is to be the sum of two internal signals, select *AM1 + AM2 internal* from the utilities (see 'Mode selection' on page 3-19). A typical display is shown in Fig. 3-16 below. Press the [AM2] key to select the second signal. Press the [AM2 Depth] key and enter the required modulation depth for the second signal. If you exceed the (99.9% – AM1) modulation depth limit, it is automatically reset to the maximum allowed value.

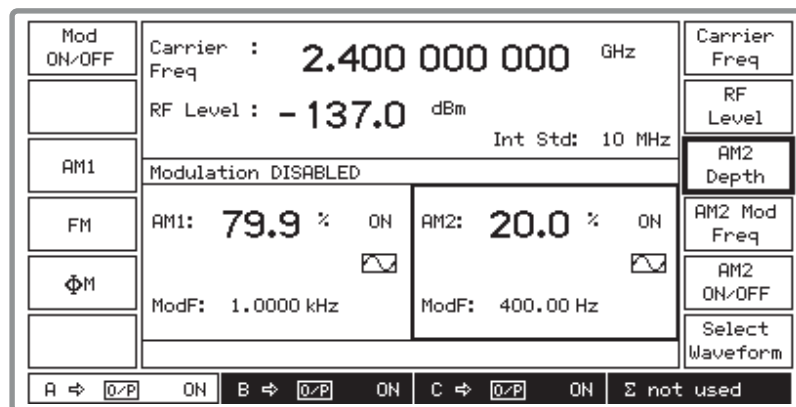

B3425

Fig. 3-16 Sig Gen menu with two modulation channels

- (5) Select [AM Mod Freq], enter the modulation frequency and terminate with the [Hz] or [kHz] key. If you exceed the 20 kHz modulation limit it is automatically reset to the maximum allowed value.
- (6) If required, change the waveform from that shown on the display (see 'Internal waveform selection' on page 3-21).
- (7) Press [AM ON/OFF] to toggle between the on and off states as shown by the display.

Frequency modulation selection

Select frequency modulation as follows:

- (1) Press [SIG GEN] to show the Sig Gen menu with the current modulation displayed in the bottom half of the screen.
- (2) Press the [FM] soft key if displayed (otherwise the instrument is already in the FM mode).
- (3) Press [FM Devn]. Enter the deviation using the numerical key pad and terminate with the [Hz] or [kHz] key. If you exceed the 100 kHz deviation limit it is automatically reset to the maximum allowed value.
- (4) If the internal modulation is to be the sum of two signals, select *FM1 + FM2 internal* from the utilities (see 'Mode selection' on page 3-19). A typical display is shown in Fig. 3-16 above. Press the [FM2] key to select the second signal. Press the [FM2 Depth] key and enter the required deviation for the second signal. If you exceed the (100 kHz – FM1) deviation limit, it is automatically reset to the maximum allowed value.
- (5) Select [FM Mod Freq], enter the modulation frequency and terminate with the [Hz] or [kHz] key. If you exceed the 20 kHz modulation limit it is automatically reset to the maximum allowed value.
- (6) If required, change the waveform from that shown on the display (see 'Internal waveform selection' below).
- (7) Press [FM ON/OFF] to toggle between the on and off states as shown by the display.

Phase modulation selection

Select phase modulation as follows:

- (1) Press [SIG GEN] to show the Sig Gen menu with the current modulation displayed in the bottom half of the screen.
- (2) Press the [ϕ M] soft key if displayed (otherwise the instrument is already in the ϕ M mode).
- (3) Press [ϕ M Devn]. Enter the deviation using the numerical key pad and terminate with the [rad] key. If you exceed the 10 rad deviation limit it is automatically reset to the maximum allowed value.
- (4) If the internal modulation is to be the sum of two signals, select ϕ M1 + ϕ M2 internal from the utilities (see 'Mode selection' on page 3-19). A typical display is shown in Fig. 3-16 above. Press the [ϕ M2] key to select the second signal. Press the [ϕ M2 Depth] key and enter the required deviation for the second signal. If you exceed the (10 rad – ϕ M1) deviation limit, it is automatically reset to the maximum allowed value.
- (5) Select [ϕ M Mod Freq], enter the modulation frequency and terminate with the [Hz] or [kHz] key. If you exceed the 20 kHz modulation limit it is automatically reset to the maximum allowed value.
- (6) If required, change the waveform from that shown on the display (see 'Internal waveform selection' on page 3-21).
- (7) Press [ϕ M ON/OFF] to toggle between the on and off states as shown by the display.

Pulse modulation selection

Pulse modulation may be selected in addition to any other normal modulation modes. The source is external from any of the PULSE INPUT sockets. Select pulse modulation as follows:

- (1) Press [UTIL] to display the *Utilities Selection Menu 1*. If the *Utilities Selection Menu 2* is displayed, it will be necessary to press the [Utils Menu 1] key.
- (2) Select [Mod'n Mode] to display the *Modulation Mode Selection Menu*.
- (3) Press the [Pulse Enab/Dis] key to toggle between the ON and OFF states until the display shows *Pulse Mod'n: ENABLED*.
- (4) Press [SIG GEN] to return to the Sig Gen menu.

- (5) Press [*Pulse ON/OFF*] to toggle between the ON and OFF states until the display shows *Pulse ON*.
When ON the carrier is controlled by the logic level applied to the PULSE INPUT socket. A logical '1' (a voltage between 3.5 and 5 V) allows carrier output, a logical '0' (a voltage between 0 and 1.0 V) suppresses it. Turning pulse mod OFF effectively applies a logical '1' allowing carrier output.

FSK selection

The instrument accepts logic level inputs to the AUXILIARY PORT connector to produce an FSK modulated output signal from each source. The input data is sampled at 100 kHz and produces a 2- or 4-level shift waveform which is filtered by a 20 kHz Bessel filter and applied to the carrier. Frequency shift keying is selected as follows:

- (1) Press [UTIL] to display the *Utilities Selection Menu 1*. If the *Utilities Selection Menu 2* is displayed, it will be necessary to press the [*Utils Menu 1*] key.
- (2) Select [*Mod'n Mode*] to display the *Modulation Mode Selection Menu*.
- (3) Use the [*Up*] and [*Down*] keys to move the selection box over the required 2FSK or 4FSK modulation mode.
- (4) Press [*Select Mode*]. The display changes to show your new current modulation mode.
- (5) Press [SIG GEN] to display the Sig Gen menu. This has been modified to show either *2 level FSK – Ext source* or *4 level FSK – Ext source* in the modulation field (see Fig. 3-17 below).

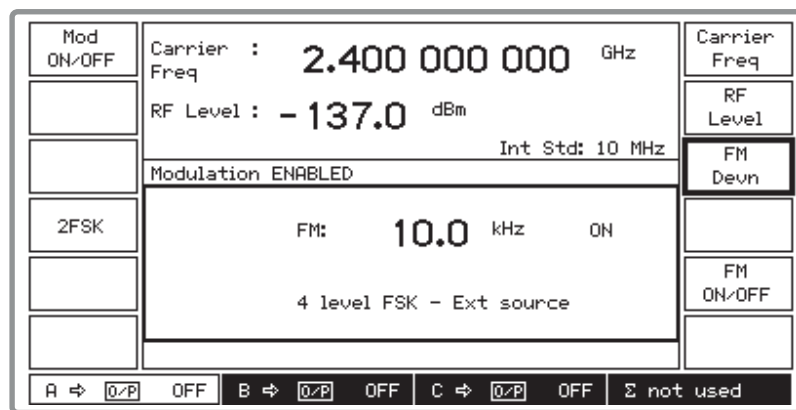

B3474

Fig. 3-17 Sig Gen menu with 4FSK selected

- (6) Press [*FM Devn*], enter the required deviation and terminate with the [Hz] or [kHz] key. If you exceed the 100 kHz deviation limit the entered value is automatically reset to the maximum allowed value.
- (7) If FSK is turned off (either locally with [*FM ON/OFF*] or globally with [*Mod ON/OFF*]) no frequency shift is applied to the carrier.

For information on the use of the AUXILIARY PORT connector for FSK operation see Chapter 2 'Auxiliary port connector' and 'FSK operation'.

Sweep

The sweep capability allows the comprehensive testing of systems, since measurements at single points will not necessarily give an overall indication of the performance. The sweep function is specified by the following parameters:

- Start frequency
- Stop frequency
- Size of step
- Time per step

The sweep can be operated in single shot or continuous modes with the start command triggered by a key press, an external pulse or GPIB control. Once started, the sweep can be stopped at any time when the display will indicate the current parameter value.

Sweep operation

- (1) Press the [SWEEP] key which causes the Sweep Control screen to be displayed. In fixed, non-sweep, mode the screen is similar to that shown in Fig. 3-18 below. In sweep mode the screen changes similar to that shown in Fig. 3-20.

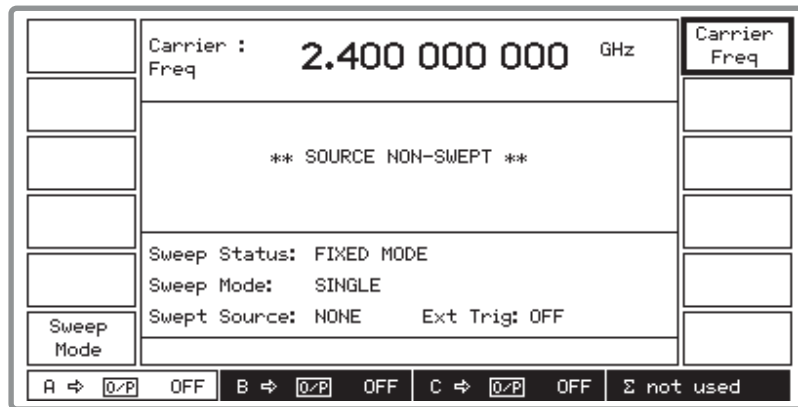

B3426

Fig. 3-18 Sweep control screen in fixed mode

- (2) Press [Sweep Mode] to display the Carrier Sweep Mode menu shown in Fig. 3-19 below.

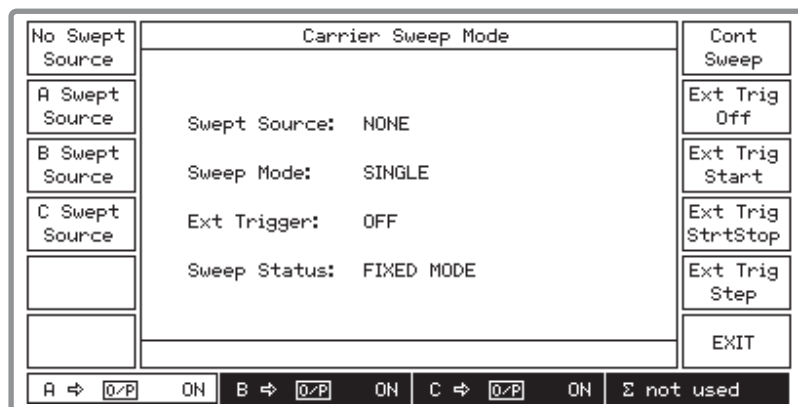

B3427

Fig. 3-19 Carrier sweep mode menu

- (3) Select the A, B or C source for sweeping by pressing the appropriate [A Swept Source], [B Swept Source] or [C Swept Source] key.
- (4) Select the sweep mode between single shot and continuous sweeping by pressing the [Sweep] key which toggles between [Single Sweep] and [Cont Sweep].
- (5) For external triggering press [Ext Trig Off] to inhibit the external trigger or press one of the following keys to select the appropriate trigger mode:
 - [Ext Trig Start] – The first trigger input causes the carrier sweep to commence sweeping. Any other trigger inputs whilst sweeping are ignored. Only at the end of each sweep is the trigger latch reset ready for the next input.
 - [Ext Trig StrtStop] – The first trigger input starts the carrier sweep and the following trigger input pauses it, so that the user can investigate a particular point of interest. The next trigger input continues the sweep from where it was paused. At the start of each sweep the trigger latch is reset ready for the next input.
 - [Ext Trig Step] – Each trigger input steps the sweep on by one frequency step. The trigger latch is reset after each step ready for the next step.
- (6) Pressing [No Swept Source] disables sweep mode.
- (7) If no source has been selected for sweeping, pressing [EXIT] will return you to the Carrier Sweep Mode Menu. Otherwise, the Sweep Control screen will be displayed.

Sweep control

- (8) The Sweep Control screen displayed is similar to that shown in Fig. 3-20 below. This is used to perform the sweeping operation.

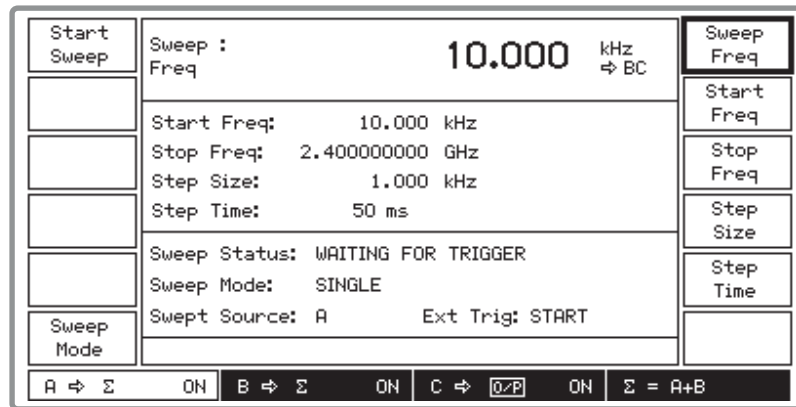

B3428

Fig. 3-20 Sweep control screen in sweep mode (B and C sources coupled to A source)

- (9) Enter the sweep start and stop frequencies using the [Start Freq] and [Stop Freq] keys.
- (10) Press [Step Size] and enter the step size in the range 1 Hz to the instrument maximum frequency, to a resolution of 1 Hz.
- (11) Press [Step Time] and enter the step time in the range 50 ms to 10 s to a resolution of 1 ms.
- (12) To start the sweep press [Start Sweep]. The key changes its function to [Stop Sweep] and Sweep Status changes from WAITING FOR TRIGGER to SWEEPING. The displayed Sweep Freq changes to show the progress of the sweep.
- (13) The sweep can be stopped at any time by pressing [Stop Sweep]. This causes the key function to change to [Continue Sweep] and Sweep Status changes to PAUSED.

- (14) Whilst the sweep is paused you can adjust the frequency by selecting [*Sweep Freq*] then using the control knob to look at a particular frequency of interest. Pressing [*Transfer*] followed by [*Continue Sweep*] causes the sweep to continue from your adjusted frequency. Otherwise simply pressing [*Continue Sweep*] restarts the sweep from where it was paused. Pressing [*Reset Sweep*] discontinues the sweep and resets it to the start frequency.
- (15) At the end of a single sweep, the stop frequency is shown and the key function changes to [*Start Sweep*] with *SWEEP COMPLETE* displayed. For continuous sweep, the sweep automatically recommences from the start frequency.
- (16) To change the sweep mode, press the [*Sweep Mode*] key which returns you to the *Carrier Sweep Mode* menu.

Utilities

Utility menu selection

Pressing the [UTIL] key gains access to the utilities options from two primary menus, *Utilities Selection Menu 1* and *Utilities Selection Menu 2*. When a selection is made from either of these menus and [UTIL] is subsequently pressed, the primary menu is re-displayed. However, if instead a selection is made and then one of the other hard keys – for example, [MEM] – is pressed, pressing [UTIL] subsequently once return to the sub-menu, pressing it again returns to the primary menu. This provides an operating short-cut in that it allows you to re-access a sub-menu without first having to go again through the primary menu.

Selection menu 1

The display for *Utilities Selection Menu 1* is shown in Fig. 3-21 below.

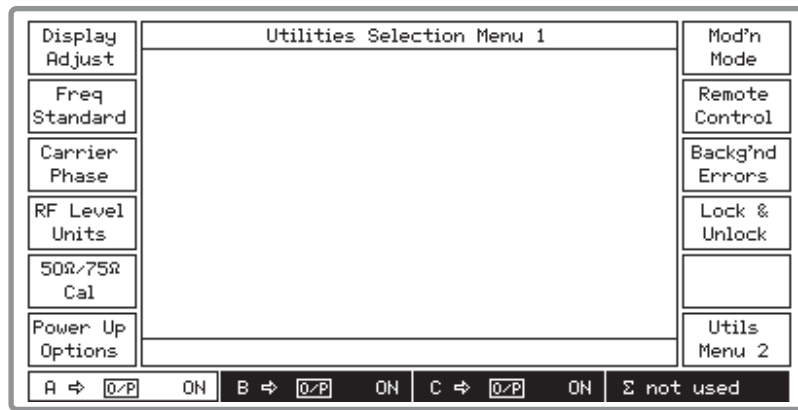

B3453

Fig. 3-21 Utilities selection menu 1

To obtain *Utilities Selection Menu 2* from the menu, select [*Utils Menu 2*].

Display adjustment (menu 1)

You can set the display contrast and brightness to suit your individual preferences using this utility. The setting can then be saved for automatic recall whenever the instrument is switched on. Proceed as follows:

- (1) Select [*Display Adjust*] to call up the *Display Adjustment Utility* shown in Fig. 3-22 below.

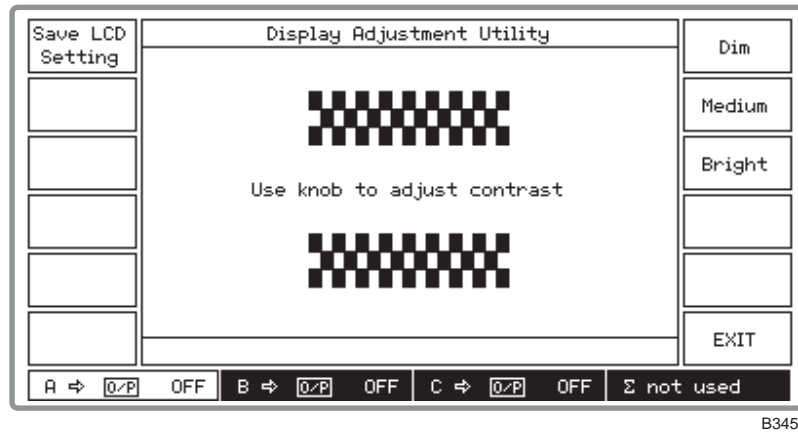

Fig. 3-22 Display adjustment utility

- (2) Set the required brightness by pressing [Dim], [Medium] or [Bright]. You can then adjust the contrast by means of the control knob.
- (3) Once adjusted, the display setting can be stored in the non-volatile memory by pressing [Save LCD Setting]. The setting will be subsequently recalled on power-up.
- (4) Press [EXIT] to return to the Utilities Selection Menu 1.

Frequency standard selection (menu 1)

This utility enables you to select a 10 MHz output as a standard for use with associated equipment. It also enables you to select a standard (either external or internal) for use by the instrument. When an external standard is selected, the internal TCXO is locked to the external standard using a phase locked loop. For a 10 MHz standard, the menu allows you to select between *direct* and *indirect*. When *direct* is selected the internal standard for the RF trays is provided directly from the external standard. When *indirect* is selected this standard is provided from the TCXO locked to the external standard. Frequency standard selection is as follows:

- (1) Select [Freq Standard] to display the *Frequency Standard Selection Menu* shown in Fig. 3-23 below. This shows the currently selected standard.

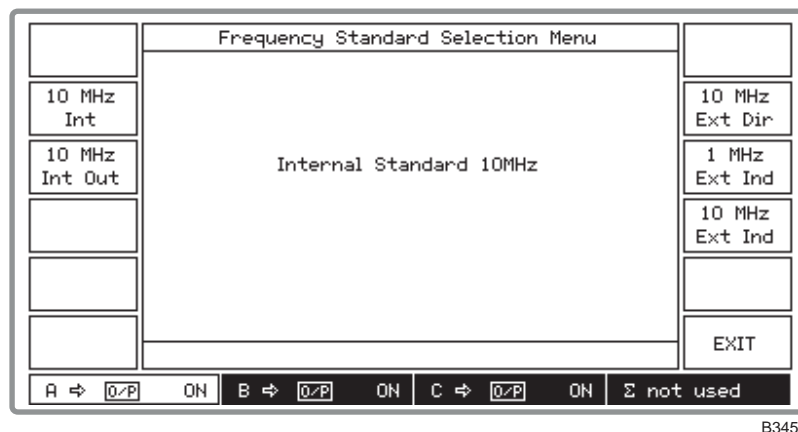

Fig. 3-23 Frequency standard selection menu

- (2) Select the internal standard for the instrument by pressing [10 MHz Int].
- (3) To provide an externally generated 1 or 10 MHz standard for the instrument, connect the signal to the rear-panel EXT STD I/P socket. Then choose one of the three external standards [10 MHz Ext Dir], [1 MHz Ext Ind] or [10 MHz Ext Ind]. You should choose

[10 MHz Ext Dir] if your provided 10 MHz standard is better than that fitted in the instrument.

- (4) To obtain an internally generated 10 MHz standard from the instrument's INT STD O/P socket, select [10 MHz Int Out].
- (5) Press [EXIT] to return to the *Utilities Selection Menu 1*.

Carrier phase adjustment (menu 1)

You can adjust the phase offset of the carrier with respect to its current phase in degrees as follows:

- (1) Press [Carrier Phase] to display the *Carrier Phase Adjustment Utility* shown in Fig. 3-24 below. This shows the currently selected phase offset for the selected signal source.

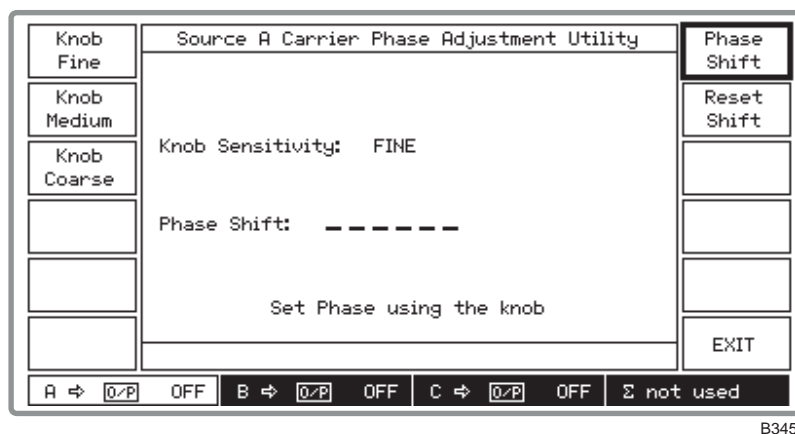

Fig. 3-24 Carrier phase adjustment utility

- (2) Select the required adjustment control by pressing [Knob Fine], [Knob Medium] or [Knob Coarse]. These provide adjustments in steps of 0.09° , 0.9° and 2.7° respectively.
- (3) Press [Phase Shift] and adjust the carrier phase using the control knob. Turn clockwise to advance the phase and anticlockwise to retard the phase. Note that if you have set the carrier phase and subsequently adjusted the carrier frequency, the menu *Phase Shift*: value will be blanked. This is because the value will then be indeterminate due to the adjustment.
- (4) To establish a reference the displayed phase shift can be reset to 0.00° by pressing [Reset Shift]. But note that this does not reset the actual phase shift, only the displayed value is reset to provide a new reference.
- (5) Press [EXIT] to return to the *Utilities Selection Menu 1*.

RF level units selection (menu 1)

RF output level units may be changed as follows:

- (1) Press [RF Level Units] to display the *RF Level Units Selection Menu* which shows the current selection (see Fig. 3-25 below).

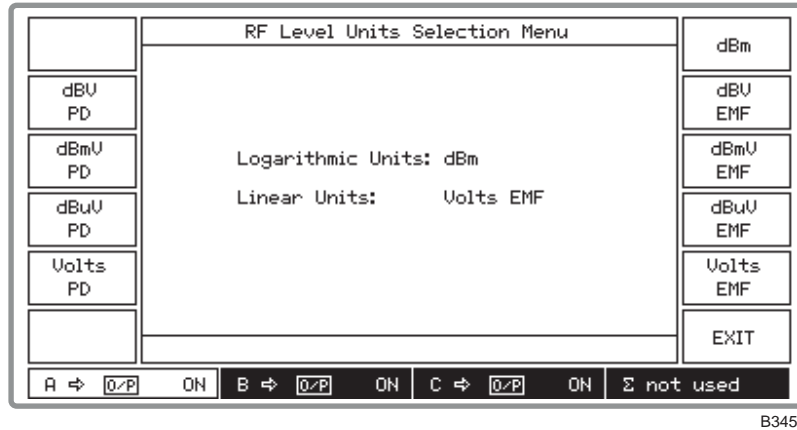

Fig. 3-25 RF level units selection menu

- (2) Select between linear and logarithmic units in EMF or PD. Logarithmic units may be referred to volts (dBV), millivolts (dBmV), microvolts (dBμV) or to 1 millivolt into 50 Ω (dBm).
- (3) Press [EXIT] to return to the Utilities Selection Menu 1.

50 Ω /75 Ω impedance selection (menu 1)

The performance specification of each signal source assumes operation into 50 Ω loads. By means of this menu in association with a 75 Ω adapter (see data sheet in Chapter 1) you can select operation into 75 Ω loads whilst maintaining correct voltage calibration. It also enables the reverse power protection circuit to function correctly. But note that in the event of an overload the RPP will function but the adapter will NOT be protected. Proceed as follows:

- (1) Press [50Ω/75Ω Cal] to display the 50 Ohm/75 Ohm Calibration Menu shown in Fig. 3-26 below.

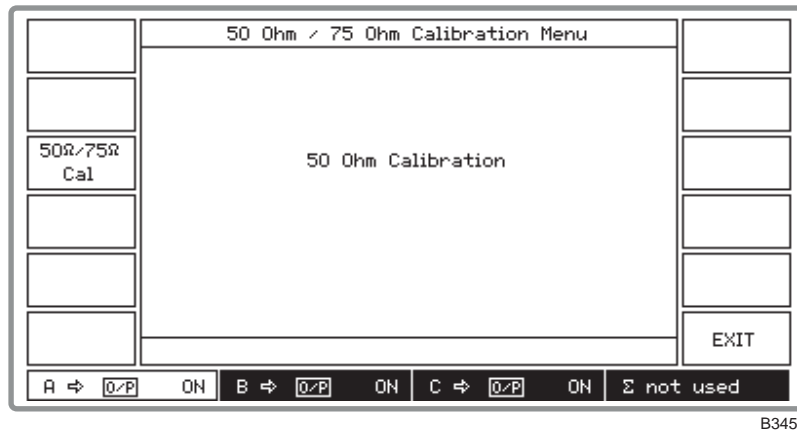

Fig. 3-26 50 ohm/75 ohm calibration menu

- (2) Press [50Ω/75Ω Cal] which toggles between 50 Ohm Calibration and 75 Ohm Calibration as shown by the screen. Note that all RF OUTPUT sockets, including the combiner's, will change calibration.
- (3) For 75 Ω operation connect a 50 Ω/75 Ω adapter to the front-panel RF OUTPUT socket for each appropriate signal source. Whenever the impedance is changed, the value of the displayed level is adjusted (by 5.7 dB) to the level at the output from the adapter.
- (4) Press [EXIT] to return to the Utilities Selection Menu 1.

Power-up options (menu 1)

The instrument can power-up in one of two states; with the factory settings or with the settings of your choice stored in one of the full memory locations. Selection is made as follows:

- (1) Press [*Power Up Options*] to display the *Power Up Options Menu* shown in Fig. 3-27 below. This shows the currently selected power-up choice.

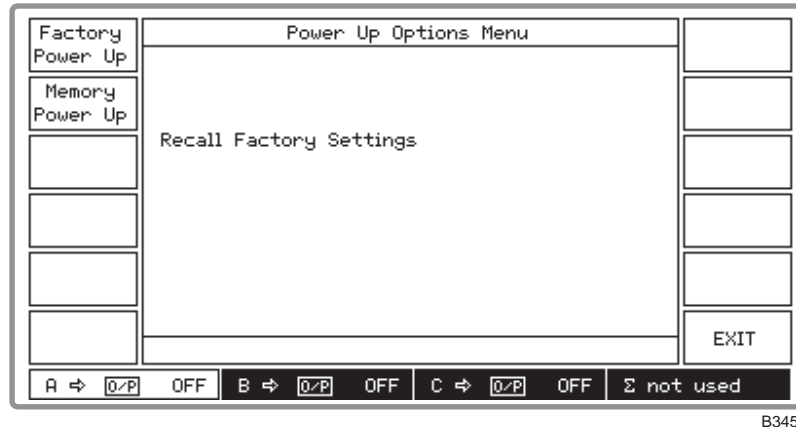

Fig. 3-27 Power up options menu

- (2) Press [*Factory Power Up*] to select the factory power-up settings (these are listed in Table 3-1 below). Otherwise press [*Memory Power Up*] to store the current settings as your selected power-up state.
- (3) Press [*EXIT*] to return to the *Utilities Selection Menu 1*.

Default settings

The instrument is reset to the factory default settings in the following cases:

- (1) At power-up to factory default settings.
- (2) Following execution of the *RST command.
- (3) When [*Factory Recall*] is pressed on the *Memory Recall Menu*.

The default settings are shown in Table 3-1.

Table 3-1 Instrument default settings

Source selected	Source A
Carrier frequency :	(Maximum available) 2.4 GHz
Step :	1 kHz
RF level	-137 dBm
Step :	1 dB
	Status: ON
Modulation mode	Internal FM, modulation disabled
Modulations :	FM1 : Deviation: 0 Hz, OFF : Internal source, frequency: 1 kHz, sine
	FM2 : Deviation: 0 Hz, OFF : Internal source, frequency: 400 Hz, sine
	Φ M1 : Deviation: 0 rad, OFF : Internal source, frequency: 1 kHz, sine
	Φ M2 : Deviation: 0 rad, OFF : Internal source, frequency: 400 Hz, sine
	AM1 : Deviation: 0%, OFF : Internal source, frequency: 1 kHz, sine
	AM2 : Deviation: 0%, OFF : Internal source, frequency: 400 Hz, sine
	Pulse : OFF :
Modulation steps :	Δ FM 1 kHz, $\Delta\Phi$ M 0.1 rad, Δ AM 1%
Mod frequency steps :	10 Hz
Carrier sweep	
Freq mode :	Fixed
Mode :	Single sweep
Ext trigger :	Off
Start :	10 kHz
Stop :	(Maximum available)
Step size :	1 kHz
Time :	50 ms

Modulation mode selection (menu 1)

Modulation mode is selected by pressing [Mod'n Mode] to display the *Modulation Mode Selection Menu* shown in Fig. 3-28 below. Using the menu is explained under 'Modulation mode selection' above.

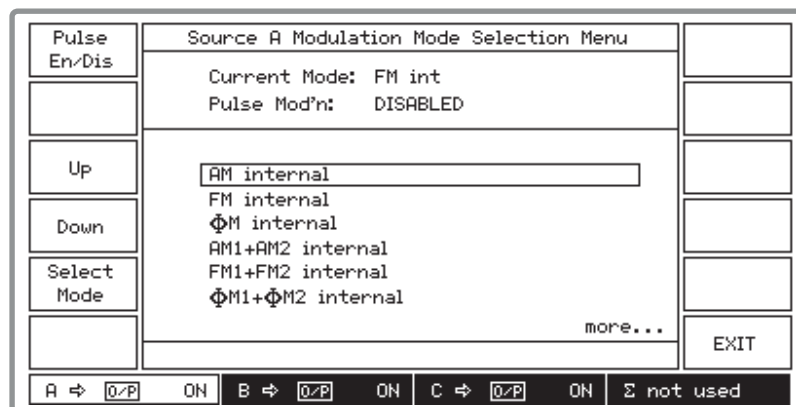

B3460

Fig. 3-28 Modulation mode selection menu

Remote control selection (menu 1)

The remote mode of operation is selected as follows:

- (1) Select [*Remote Control*] to display the *Remote Control Utility*. This shows the currently selected remote mode (see Fig. 3-29 below).

Remote Control Utility		Baud Rate
GPIB/RS232	Remote Operation : GPIB	GPIB Address
Data Bits	RS232 Settings	
Stop Bits	Baud Rate (300 - 9600) : 9600 ----	
Parity	Data Bits (7 or 8) : 7	
Hardware Hndshk	Stop Bits (1 or 2) : 1	
XON/XOFF Hndshk	Parity (None/Odd/Even) : None	
	Hardware Handshaking : OFF	
	XON/XOFF Handshaking : OFF	
	GPIB Settings	
	GPIB Address (0 - 30) : 00 --	EXIT
A ⇄ [0/P] ON B ⇄ [0/P] ON C ⇄ [0/P] ON Σ not used		

B3475

Fig. 3-29 Remote control utility

- (2) Press [*GPIB/RS232*] to toggle between *GPIB* and *RS232*.

GPIB mode

- (3) Press [*GPIB Address*] and enter the address, which must be unique on the system to the instrument and within the range 0 to 30.

RS-232 mode

- (3) Press [*Data Bits*] to toggle between 7 and 8 data bits.
- (4) Press [*Stop Bits*] to toggle between 1 and 2 stop bits.
- (5) Press [*Parity*] to cycle through the selections *None*, *Odd*, *Even*.
- (6) Press [*Hardware Hndshk*] and [*XON/XOFF Hndshk*] to select any combination between both *OFF* to both *ON*.
- (7) Press [*Baud Rate*] and set the baud rate in the range 300 to 9600 bit/s. But note that if the entered value is not one of the following standard settings, the next higher value will be selected by default.

300
600
1200
2400
4800
9600

- (8) Press [*EXIT*] to return to the *Utilities Selection Menu 1*.

Background error reporting (menu 1)

Background errors are generated due to an incorrect operating condition within the instrument. These error messages are generated automatically to warn the operator. Although there is room only to display one message in the error message field of the displays, this utility enables a complete list of the current background errors to be shown. Proceed as follows:

- (1) Press [*Backg'nd Errors*] which causes the *Current Background Errors* display similar to that in Fig. 3-30 below to be shown. The errors are shown in priority order.

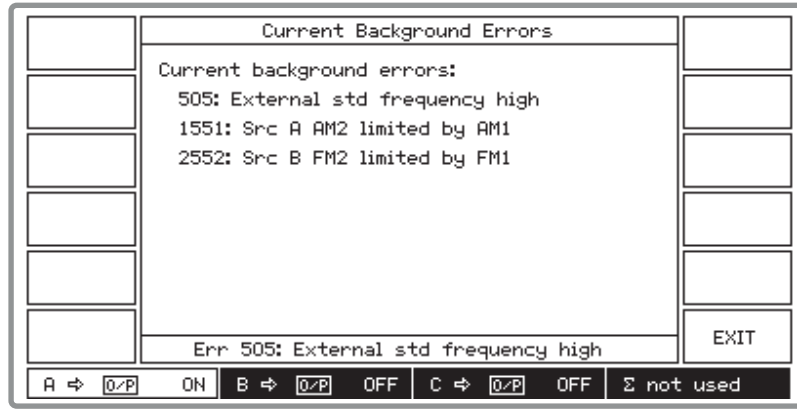

B3476

Fig. 3-30 Current background errors display (showing example errors)

- (2) Where there are more background errors than can be displayed on one screen page, the [Next Page] and [Previous Page] soft keys will be displayed to enable more than one page of errors to be viewed.
- (3) Press [EXIT] to return to the Utilities Selection Menu 1.

Protection locking and unlocking (menu 1)

To prevent accidental interference with the contents of internal memories, internal data is protected by secure key sequences. There are two levels of protection. The most secure, Level 2, is used for memory erasure, elapsed time reporting and for servicing purposes such as altering the calibration data of the instrument. Level 1 protection is used for display blanking and memory protection.

The lock and unlock utility is selected as follows:

- (1) Select [Lock & Unlock] to display the Lock & Unlock Utility. When Level 1 and Level 2 are both locked the display will be similar to Fig. 3-31 below.

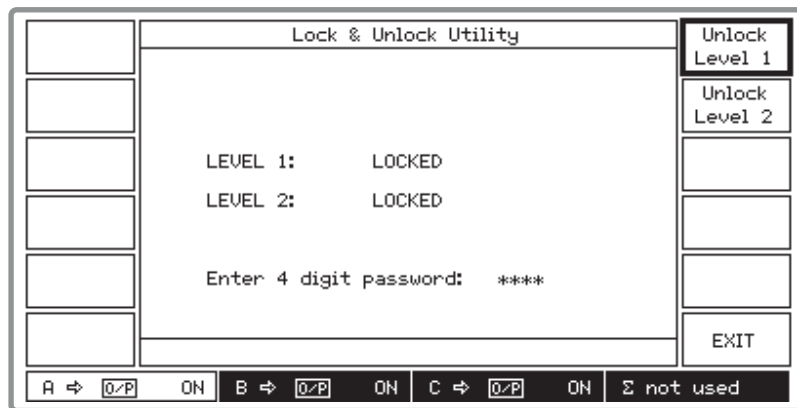

B3477

Fig. 3-31 Lock and unlock utility (during password entry)

- (2) To unlock to Level 1 press [Unlock Level 1] and enter a 4-digit password (the default is 1234). As each digit is entered an asterisk is displayed. Terminate with [ENTER].
- (3) To unlock to Level 2 press [Unlock Level 2] and enter a 6-digit password (the default is 123456). As each digit is entered an asterisk is displayed. Terminate with [ENTER].
- (4) When successful, UNLOCKED is displayed on the screen against the appropriate level and the [Unlock Level 1] or [Unlock Level 2] key is blanked. If the entered password is not recognized by the instrument the password will have been changed by operating personnel.
- (5) To lock the instrument, press the appropriate [Lock Level 1] or [Lock Level 2] key.

(6) Press [EXIT] to return to the *Utilities Selection Menu 1*.

Note

If you have lost or forgotten the password contact our Customer Services or your nearest agent (for addresses see inside rear cover). You will be required to give the instrument's serial number.

Selection menu 2

Press the [Utils Menu 2] on the *Utilities Selection Menu 1* to obtain the display for *Utilities Selection Menu 2* as shown in Fig. 3-32 below. Some of the items on this menu are intended for use in servicing and are described in the maintenance manual. As a result, some of these keys appear only when unlocked to the appropriate Level.

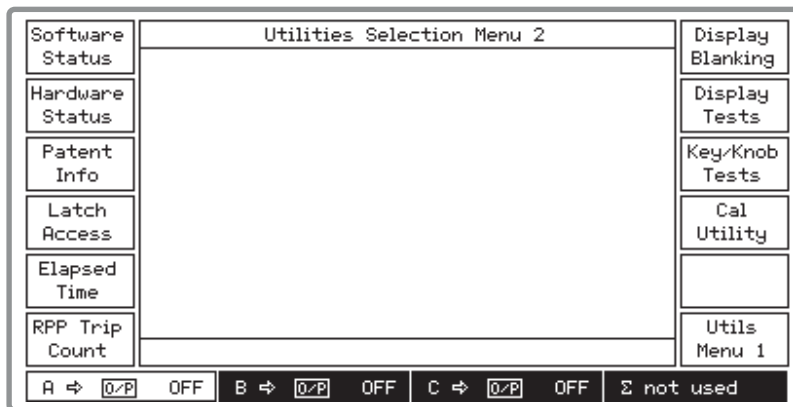

B3478

Fig. 3-32 Utilities selection menu 2

To obtain *Utilities Selection Menu 1* from the menu, select [Utils Menu 1].

Software information (menu 2)

You can obtain a description of the instrument's software by pressing [Software Status] which causes Fig. 3-33 below to be displayed. This shows the software version and date as well the EPROM part number.

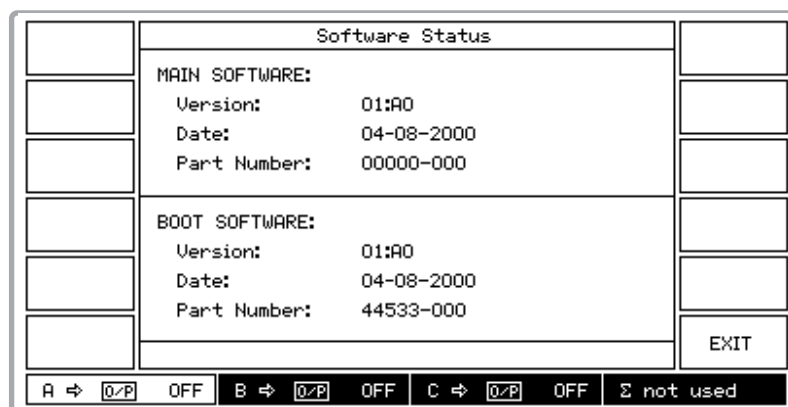

B5013

Fig. 3-33 Software status display

(1) Press [EXIT] to return to the *Utilities Selection Menu 2*.

Hardware information (menu 2)

You can obtain a description of the instrument's hardware by pressing [*Hardware Status*] which causes Fig. 3-34 below to be displayed. This shows the instrument type and serial number as well as options fitted.

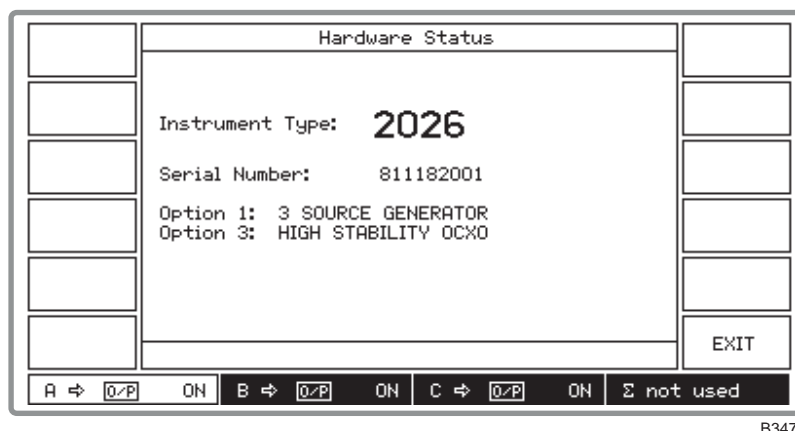

B3479

Fig. 3-34 Hardware status display

- (1) Press [*EXIT*] to return to the *Utilities Selection Menu 2*.

Patent information (menu 2)

To obtain the more important patent information, press [*Patent Info*] which causes Fig. 3-35 below to be displayed.

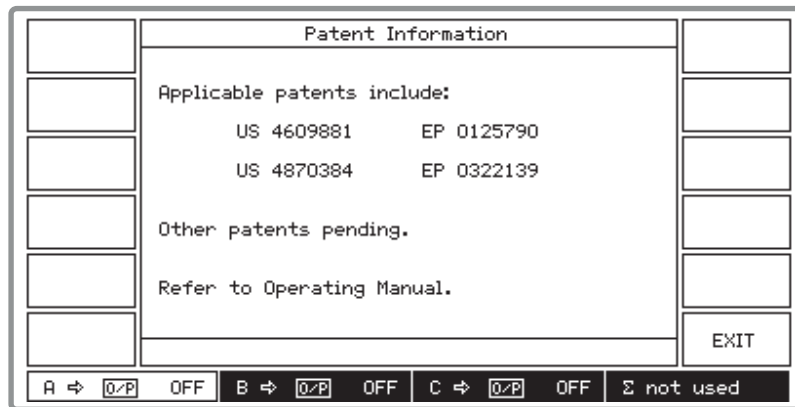

B3480

Fig. 3-35 Patent information display

- (1) For a full list of patents refer to 'Patent protection' in the Preface.
- (2) Press [*EXIT*] to return to the *Utilities Selection Menu 2*.

Display blanking (menu 2)

This facility is used to prevent sensitive data from being displayed. It allows various parts of the display to be replaced by a series of dashes so that values entered by the user or recalled from the memory will not be visible.

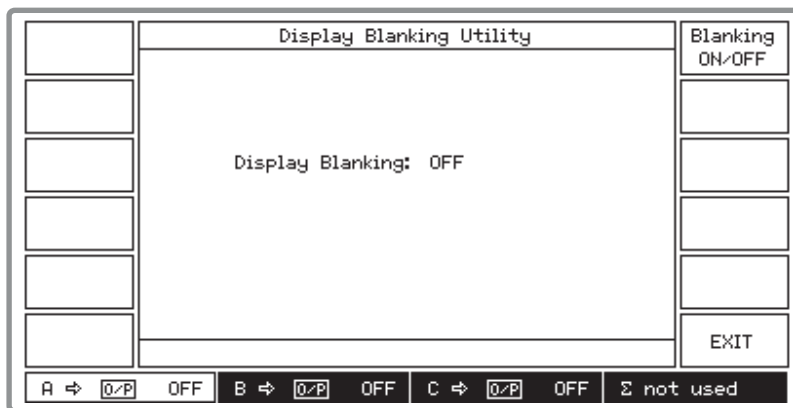

B3481

Fig. 3-36 Display blanking utility

- (1) Unlock the protection to Level 1 by means of the *Lock & Unlock Utility* (menu 1).
- (2) Press [*Display Blanking*] which causes the screen shown in Fig. 3-36 above to be displayed.
- (3) To blank the screen press the [*Blanking ON/OFF*] key which toggles between the on and off states.
- (4) Press the [SIG GEN] key to display the main screen. Here it can be seen that the main parameters are blanked and replaced by dashes. This also applies to the parameters displayed on the Sweep Control screen.
- (5) Press [*EXIT*] to return to the *Utilities Selection Menu 2*.

Latch access utility (menu 2)

This utility is intended for use as a diagnostic aid by allowing data to be sent to latches within the instrument. For further information consult the maintenance manual. The menu is shown in Fig. 3-37 below.

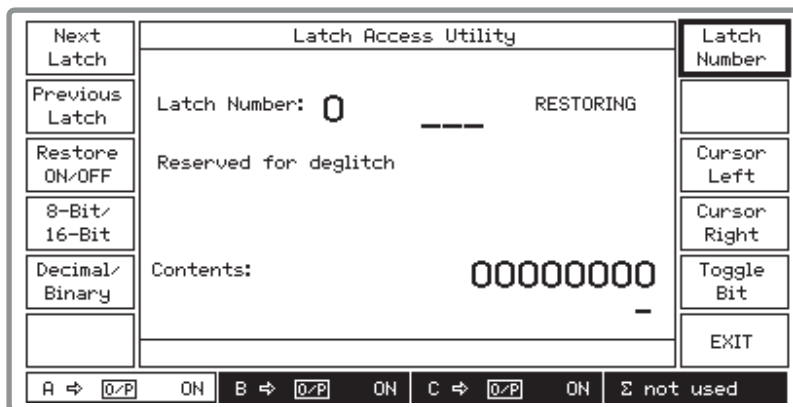

B3530

Fig. 3-37 Latch access utility

Elapsed time (menu 2)

The elapsed time facility displays the total number of operating hours as well as the number of elapsed operating hours since the last reset by the [*Reset Elapsed*] key. This facility can be used to assess the instrument's operational reliability and utilization. To use this facility the instrument must be unlocked to Level 2. The screen is shown in Fig. 3-38 below.

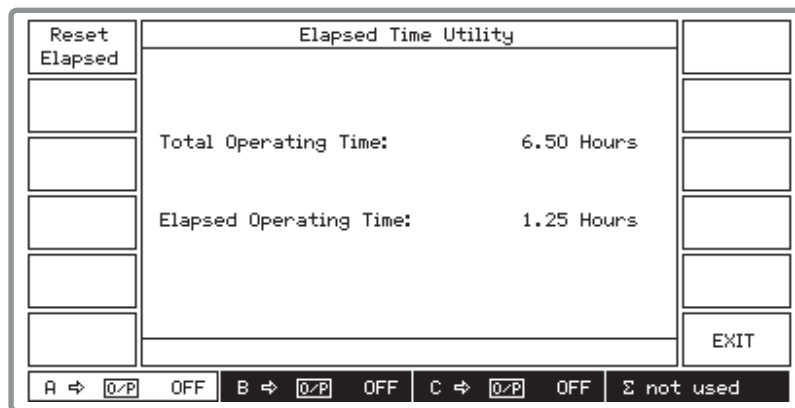

B3516

Fig. 3-38 Elapsed time utility

RPP trip count utility (menu 2)

This utility lists the number of times each of the fitted sources has tripped. The screen is shown in Fig. 3-39 below.

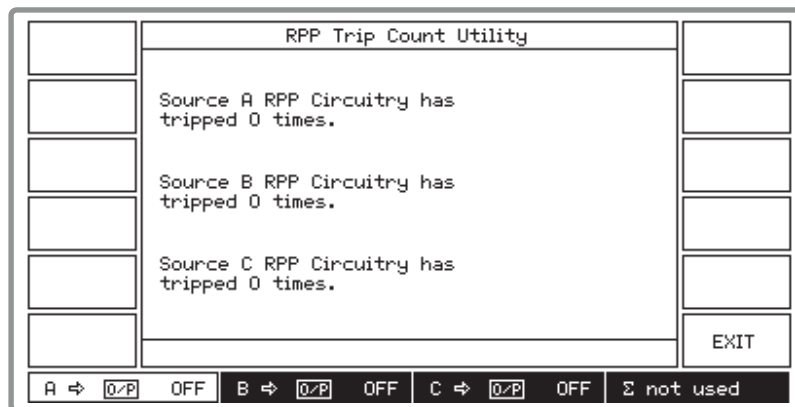

B3526

Fig. 3-39 RPP trip count utility

Display test utility (menu 2)

This utility provides a simple test of the display. The screen is shown in Fig. 3-40 below.

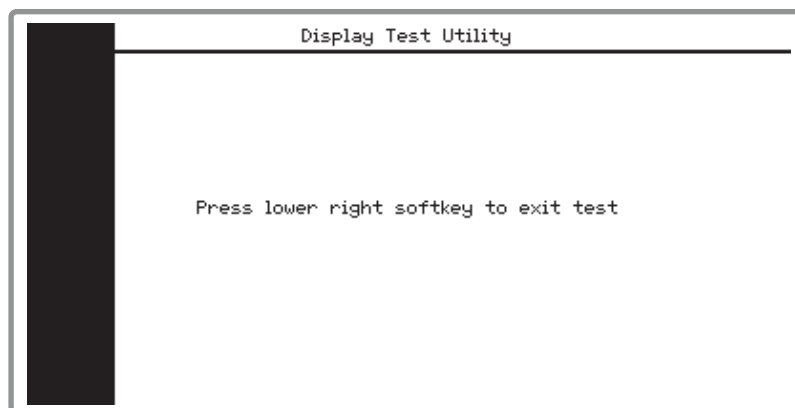

B3527

Fig. 3-40 Display test utility

Key/knob tests (menu 2)

In this utility the user is invited to operate the keys and control knob whilst checking the reaction of the instrument. The screen is shown in Fig. 3-41 below.

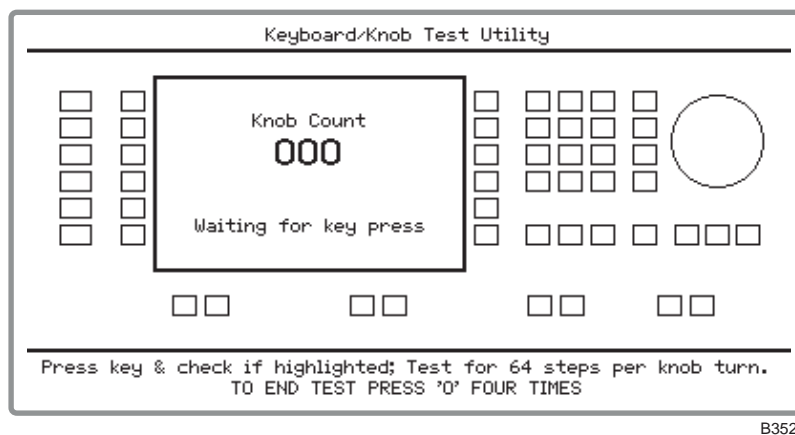

Fig. 3-41 Keyboard/knob test utility

Calibration utility (menu 2)

This menu shows when each individual item was last adjusted and enables you to enter the date of the current adjustment. The instrument must be unlocked to Level 2 to use this utility. Full details regarding calibration can be found in the maintenance manual. The first page of the menu is shown in Fig. 3-42 below.

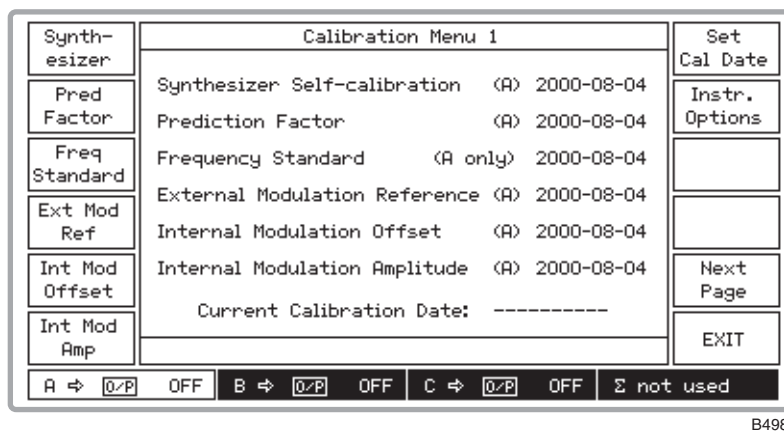

Fig. 3-42 Calibration menu

Memory

Memory stores

There are three types of store: carrier, full and RAM. Both carrier and full stores are non-volatile. The contents of the RAM store are lost when the instrument is switched off.

Each type of store holds the data for all fitted sources.

Carrier store

The non-volatile carrier frequency store has 100 locations numbered 0 to 99 for the storage of carrier frequency only. This store can be used to apply a set of test conditions to a range of frequencies. For example, if you wish to use the same modulation at a variety of frequencies you can use the carrier store to set the instrument to each of the frequencies in turn. When a carrier store is used it will only replace the current carrier frequency – all the other settings will remain unchanged.

Full store

The non-volatile full store has 100 locations numbered 0 to 99 for the storage of instrument settings. This store is used to store those parameters which currently affect the RF output; carrier frequency, RF level, modulations in use, on/off and source information and the two modulation oscillator frequencies in use.

A full store contains the following information:

- Carrier frequency setting
- Carrier frequency step size
- RF level setting
- RF level step size
- All modulation settings
- All modulation step sizes
- Modulation mode and status
- The active modulation frequencies
- The modulation frequency step size
- All sweep settings

RAM store

The volatile RAM store has locations numbered from 0 to 99 for the full storage of instrument settings. The parameters stored are the same as those for the full store. However, the RAM store has no long-term wear-out mechanism and is therefore recommended for use in ATE programs where all the settings to be used in a test sequence are initially declared and then recalled. This results in a reduction of the GPIB/RS-232 overhead.

Storing data

Select the memory store function as follows:

- (1) Press the [MEM] hard key and then, if necessary, press the [Store/Recall] soft key to display the *Memory Store Menu* shown in Fig. 3-43 below.

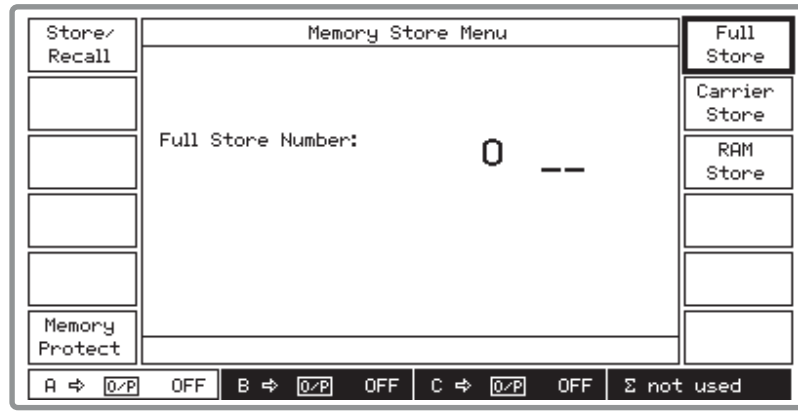

Fig. 3-43 Memory store menu

- (2) To store data, press the [Full Store], [Carrier Store] or [RAM Store] key for the type of store required, then enter the store location via the numerical key pad and terminate with [ENTER].

Note that memory erasure requires unlocking to Level 2 (see ‘Protection locking and unlocking’ on page 3-38).

Memory protection

Memory stores may be protected against accidental overwriting of the contents.

Memory protection summary

- (1) To see which store locations are protected (or unprotected), press the [Memory Protect] key. If the instrument is in the protection locked state, the *Memory Write Protection Summary* shown in Fig. 3-44 below is displayed. Otherwise Fig. 3-45 below is shown.

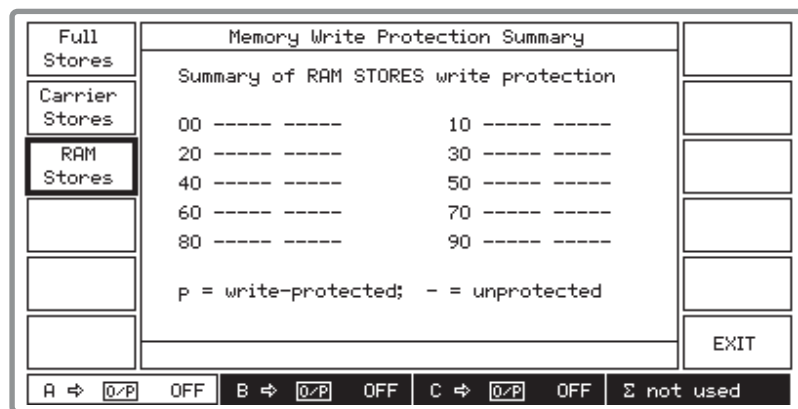

Fig. 3-44 Memory write protection summary

- (2) From the summary, select the type of memory stores to be displayed by selecting between [Full Stores], [Carrier Stores] and [RAM Stores]. An unprotected store is indicated by a dash (-), a protected store is indicated by the letter **p**.

- (3) Press [EXIT] to return to the *Memory Store Menu*.

Memory protection menu

- (4) To change the write protection, the instrument must be unlocked to Level 1 (see 'Protection locking and unlocking' on page 3-38). Subsequently pressing [Memory Protect] causes the *Memory Write Protection Menu* similar to that shown in Fig. 3-45 below to be displayed.

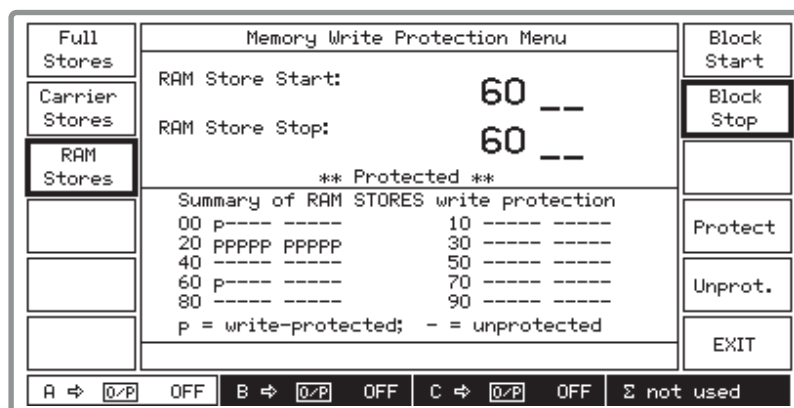

Fig. 3-45 Memory write protection menu

- (5) Select the type of memory stores to be changed by selecting between [Full Stores], [Carrier Stores] and [RAM Stores]. An unprotected store is indicated by a dash (-), a protected store is indicated by the letter **p**.
- (6) To change the protection for a memory block enter the [Block Start] and [Block Stop] numbers. For a single store make both numbers the same.
- (7) Select [Protect] or [Unprot.] as required. This action is acknowledged by the message **** Protected **** or **** Unprotected **** appearing respectively.
- (8) Press [EXIT] to return to the *Memory Store Menu*.

Note that at power-on the volatile RAM stores are unprotected to allow immediate use.

Memory recall

There are three types of recall: carrier, full and RAM. Both carrier and full stores are non-volatile. The contents of the RAM store are lost when the instrument is switched off.

Carrier recall

The non-volatile carrier frequency store has 100 locations numbered 0 to 99 for carrier frequency only. These can be recalled and used in conjunction with full recall to apply a set of test conditions to a range of frequencies.

Full recall

The non-volatile store has 100 locations numbered 0 to 99 for the storage of instrument settings. These stores may be recalled and used to reset the instrument's parameters to those which affect the RF output: carrier frequency, RF level, modulations in use, on/off and source information and the two modulation oscillator frequencies in use.

RAM recall

The volatile RAM store has 100 locations numbered 0 to 99 for the full storage of instrument settings. The parameters that are recalled are the same as those for full recall.

Recalling data

Select the memory recall function as follows:

- (1) Press the [MEM] hard key and then, if necessary, press the [Store/Recall] soft key to display the *Memory Recall Menu* shown in Fig. 3-46 below.

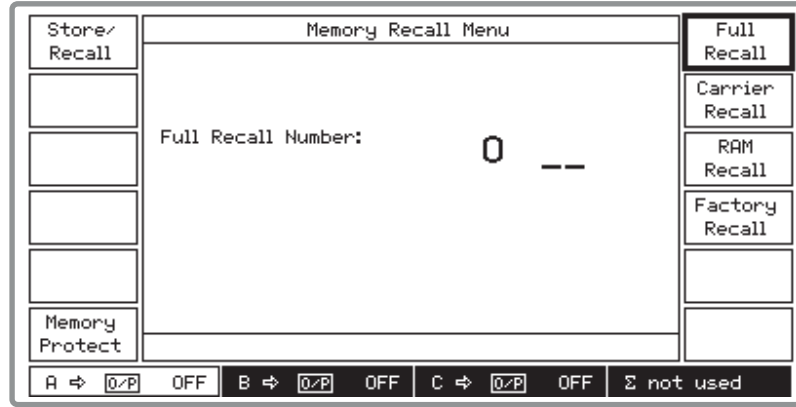

B3485

Fig. 3-46 Memory recall menu

- (2) To recall data, press the [Full Store], [Carrier Store] or [RAM Store] key for the type of recall required, then enter the store location via the numerical key pad and terminate with [ENTER].
- (3) Pressing [Memory Protect] causes a *Memory Write Protection* screen to be displayed. For details of displaying the stores and changing their protection states see 'Memory protection' on page 3-46.
- (4) Press [Factory Recall] to set the instrument to the factory settings (these are listed in Table 3-1 above).

Error messages

Error handling

Error messages are divided into four groups:

- (1) Background errors – represent a condition of the instrument.
- (2) Foreground errors – generally caused by the user.
- (3) GPIB errors – generated by incorrect programming.
- (4) Fatal errors – caused by failure associated with the main RAM or the PROM. These errors may or may not be displayed according to the severity of the failure or corruption.

Background errors:

These are generated due to an incorrect operating condition within the instrument. These errors are generated automatically to warn the operator. For example if the reverse power protection circuit should trip the message: *Err 500: RPP tripped* will be displayed on the main screen. Background errors are listed in Table 3-2. Only one error will be displayed, that with the highest priority. To obtain a full list of errors occurring on your instrument in priority order, select [*Back'nd Errors*] from the *Utilities Selection Menu 1*. This causes the *Current Background Errors* screen to be displayed (see Fig. 3-30). Select [*Next Page*] if the list is continued on a subsequent page.

Foreground errors:

These are typically generated when an entered parameter value is outside the valid range or for some other invalid operation. For example trying to set the carrier frequency above or below the specified range will display the following message *Err 100: Carrier limit* on the screen. The foreground errors are cleared upon function selection or by re-entering the parameter correctly. Foreground errors are listed in Table 3-3.

Error message priority:

A background error has a priority bit set which is used to determine which message needs to be displayed. A foreground error will temporarily overwrite the background error if currently displayed, but will return to displaying that error once the foreground error has been cleared.

GPIB errors

When an error occurs the error number is put into the error queue and the error message is displayed. Clearing the error message from the screen does not clear the error queue, which is only cleared by the GPIB command *ERROR?* query, which returns the error at the head of the queue, or by the **CLS* command which clears the whole error queue. GPIB errors are listed in Table 3-4.

The queue holds a maximum of 64 error message error numbers. If an error occurs while the queue is full the last error number is replaced with 399 to indicate that the queue is full. The *ERROR?* query returns a value of 399 for queue full and 0 for queue empty.

When an error number is written into the queue, a bit (<erb>) in the status byte register is set, and an appropriate bit in the standard event register is also set (one of <cme>, <exe>, <dde> or <qye>). These errors will also generate SRQ if the relevant bit in the status register is set. Many background errors are also reported in the Hardware and Coupling Status Registers.

Source-specific errors

Where it is necessary to identify the signal source causing an error, the error message number has 1000, 2000 or 3000 added to it for the A, B and C sources respectively. Thus error number 2500 indicates that the B source has tripped the reverse power protection circuit.

Table 3-2 Background errors (500–599) in priority order

–	–	–	591	ftl	Main PROM faulty
590	ftl	Main RAM faulty	–	–	–
–	–	–	–	–	–
–	–	–	–	–	–
–	–	–	–	–	–
500	dde	RPP tripped ‡	501	dde	Fractional-N loop low ‡
502	dde	Fractional-N loop high ‡	503	dde	Ext standard missing
504	dde	External std frequency low	505	dde	External std frequency high
506	dde	VCXO loop low ‡	507	dde	VCXO loop high ‡
508	dde	Amplitude mod unlevelled ‡	509	dde	Output unlevelled ‡
510	dde	High power amplifier failed ‡	511	dde	ALC too high ‡
512	dde	ALC too low ‡	513	dde	DSP not responding ‡
–	–	–	–	–	–
–	–	–	–	–	–
–	–	–	549	exe	RF level uncalibrated ‡
550	exe	RF level limited by AM ‡	551	exe	AM2 limited by AM1 ‡
552	exe	FM2 limited by FM1 ‡	553	exe	ΦM2 limited by ΦM1 ‡
554	–	–	555	–	–
556	–	–	557	exe	Carrier limited by coupling ‡
558	exe	Offset limited by harmonic	559	exe	Offset limited by sub-harm
560	exe	Harmonic limited by offset	561	exe	Sub-harm limited by offset

(‡ = Source-specific)

Table 3-3 Foreground errors (0–399)

0	dde	No error	1	dde	EEPROM checksum
2	dde	Pad cal checksum †	3	dde	RF cal checksum †
4	dde	Freq std checksum †	5	dde	Synthesizer cal checksum †
6	dde	Mod ref checksum †	7	dde	Mod offset checksum †
8	dde	Mod amp checksum †	9	dde	ALC cal checksum †
10	dde	FM cal factor checksum †	11	dde	FM tracking checksum †
12	dde	ΦM cal factor checksum †	13	dde	System cal checksum †
14	dde	AM cal checksum †	15	dde	Store checksum
16	dde	Image checksum	17	dde	EEPROM unreliable
20	dde	Frac-N out of lock at <freq> †	21	dde	VCO cal fail at <freq> †
22	dde	VTF tune cal fail at <freq> †	23	dde	FM tracking cal fail at <freq> †
24	dde	Local EEPROM write	51	dde	Keyboard buffer overflow
52	dde	Display buffer overflow	53	dde	Display missing
62	dde	Source not fitted †	–	–	–
100	exe	Carrier limit †	101	exe	Carrier step limit †
102	exe	RF level limit †	103	exe	RF level step limit †
104	exe	Invalid modulation mode †	105	exe	AM limit †
106	exe	AM2 limit †	107	exe	AM step limit †
108	exe	AM2 step limit †	109	exe	FM limit †
110	exe	FM2 limit †	111	exe	FM step limit †
112	exe	FM2 step limit †	113	exe	ΦM limit †
114	exe	ΦM2 limit †	115	exe	ΦM step limit †
116	exe	ΦM2 step limit †	117	exe	Memory limit
118	exe	AM mod freq limit †	119	exe	AM mod step limit †
120	exe	AM2 mod freq limit †	121	exe	AM2 mod step limit †
122	exe	FM mod freq limit †	123	exe	FM mod step limit †
124	exe	FM2 mod freq limit †	125	exe	FM2 mod step limit †
126	exe	ΦM mod freq limit †	127	exe	ΦM mod step limit †
128	exe	ΦM2 mod freq limit †	129	exe	ΦM2 mod step limit †
130	exe	Return/Transfer not allowed	131	exe	Util limit
132	exe	Start freq limit †	133	exe	Stop freq limit †
134	exe	Sweep time limit	135	exe	Sweep mode disabled †
136	exe	Carrier phase limit †	137	exe	AM phase limit †
138	exe	FM phase limit †	139	exe	ΦM phase limit †
140	exe	Memory store limit	141	exe	Memory recall limit
142	exe	Display blanking limit	143	exe	GPIB address limit
144	exe	Latch address limit	145	exe	Latch data limit
146	exe	Freq std carrier limit †	147	exe	Freq std course adj limit †
148	exe	Freq std fine adj limit †	149	exe	Mod ref adj limit †
170	exe	Util not available	171	exe	Entry outside limits
172	exe	Data out of range	173	exe	Units not valid
174	exe	Unlev fact limited by FM fact †	175	exe	Invalid baud rate
176	exe	Data overrun	177	exe	Data parity
178	exe	Data framing	179	exe	Break in data

continued

Foreground errors (0–399) - continued

180	exe	Transmit buffer full	181	exe	Receiver not enabled
182	exe	Protected utility – Level 1	183	exe	Protected utility – Level 2
184	–	–	185	exe	This store is Read Only
186	–	–	187	–	–
188	exe	Receive buffer full	189	exe	Pulse has been disabled ‡
190	exe	No attenuator fitted	191	exe	No high power amp fitted
192	–	–	193	exe	Ext DCFM mod mode required ‡
–	–	–	195	exe	Invalid coupling mode ‡
196	exe	Invalid in application mode	–	–	–
198	exe	Atten lock disabled	199	exe	Atten lock not allowed ‡
200	exe	Atten lock not allowed	201	exe	Atten lock not allowed ‡
202	exe	No pulse with application	–	–	–
398	–	–	399	exe	Error queue full

(‡ = Source-specific)

Table 3-4 GPIB errors (400–499)

400	cme	Syntax error	401	cme	Unrecognized mnemonic
402	cme	Numeric syntax	403	cme	Data expected
404	cme	Illegal data	405	cme	Too much data
406	cme	Incorrect data type	407	cme	Unrecognized character data
408	cme	Character data not unique	409	cme	Block definition
410	cme	Block size	411	cme	Missing quote
412	cme	Terminator expected	413	cme	Invalid unit
414	cme	Unit not expected	415	cme	No header match found
416	cme	Header not unique	417	cme	Illegal star command
418	cme	Sub-command not allowed	419	cme	Action not allowed with header
420	cme	Query not allowed with header	421	cme	Parser decode
–	–	–	–	–	–
–	–	–	–	–	–
–	–	–	–	–	–
–	–	–	–	–	–
450	qye	Query INTERRUPTED	451	qye	Query UNTERMINATED
452	qye	Query DEADLOCK	453	qye	Query lost after arbitrary char
–	–	–	–	–	–
–	–	–	–	–	–
–	–	–	–	–	–

Chapter 4

SETUP

Contents

Summary	4-2
Setup menu selection	4-2
Combiner setup	4-3
Combiner selection	4-3
External source	4-4
Coupling	4-5
Frequency and level coupling	4-5
Coupling selection	4-5
Applications	4-7
Applications summary	4-7
Applications selection	4-7
Amplifier intermodulation distortion application	4-8
Two-tone test	4-8
Three-tone test	4-8
Procedure	4-8
Receiver two-tone intermodulation application	4-12
Procedure	4-12
Receiver selectivity application	4-15
Procedure	4-15

List of figures

Fig. 4-1 Setup menu (shown for three sources fitted)	4-2
Fig. 4-2 Combiner setup menu	4-3
Fig. 4-3 Combiner setup menu, showing link between C source and combiner	4-4
Fig. 4-4 Frequency and level coupling menu	4-5
Fig. 4-5 Applications selection menu (shown for three sources fitted)	4-7
Fig. 4-6 Intermod. distortion test on amplifier block diagram	4-8
Fig. 4-7 Intermod. distortion test on amplifier spectral diagram	4-9
Fig. 4-8 Intermod. distortion test on amplifier: 2-tone selected	4-9
Fig. 4-9 Intermod. distortion test on amplifier: 3-tone selected	4-10
Fig. 4-10 Intermod. distortion test on amplifier: modulation setup menu, ϕ M selected	4-10
Fig. 4-11 Intermod. distortion test on amplifier: Source summary screen	4-11
Fig. 4-12 Setup menu in application mode	4-11
Fig. 4-13 Two-tone intermod. measurement on receiver block diagram	4-12
Fig. 4-14 Two-tone intermod. measurement on receiver: spectral diagram	4-12
Fig. 4-15 Two-tone intermod. measurement on receiver: application accepted	4-13
Fig. 4-16 Two-tone intermod. measurement on receiver: modulation setup menu	4-13
Fig. 4-17 Two-tone intermod. measurement on receiver: interferer mod setup menu	4-14
Fig. 4-18 Two-tone intermod. measurement on receiver: source summary	4-14
Fig. 4-19 Setup menu in application mode	4-15
Fig. 4-20 Receiver selectivity block diagram	4-15
Fig. 4-21 Receiver selectivity spectral diagram	4-16
Fig. 4-22 Receiver selectivity: application accepted	4-16
Fig. 4-23 Receiver selectivity: receiver modulation setup menu	4-17
Fig. 4-24 Receiver selectivity: interferer modulation setup menu	4-17
Fig. 4-25 Receiver selectivity: source summary	4-18
Fig. 4-26 Setup menu in application mode	4-18

Summary

The setup menus are used to route the outputs from the signal sources to either their individual RF OUTPUT sockets or, via the combiner, to the COMBINER RF OUTPUT socket and additionally allow the sources to be coupled together by a mathematical formula in both frequency and level. The routing is set using the combiner setup facility and the coupling parameters are enabled and set using the coupling setup facility.

The applications facility allows the user to select one of a number of common test configurations, such as intermodulation testing, for two or three signal sources. When an application is selected the most appropriate signal routing is automatically chosen and the required coupling controls enabled. Control parameters are then redefined in terms of the measurement being performed to minimize the number of parameter entries required. For example for intermodulation testing with equal amplitude sources, only one RF level control is provided and this automatically sets the level of all of the sources. Control parameters are described in terms which are relevant to the measurement being performed.

Setup menu selection

Pressing the [SETUP] key gains access to the *Setup Menu* similar to that shown in Fig. 4-1 below.

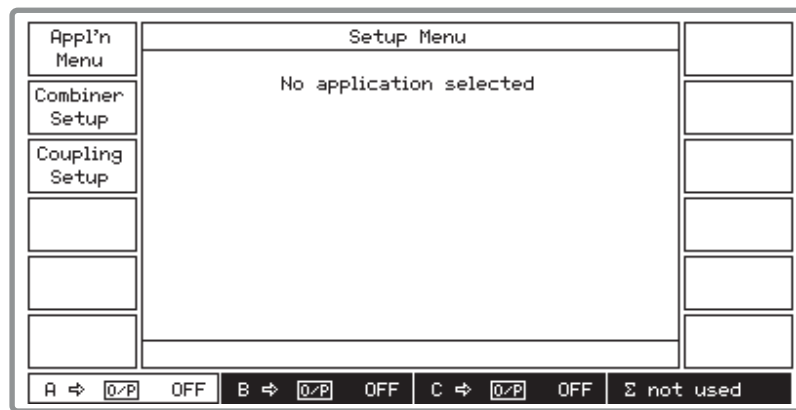

B3411

Fig. 4-1 Setup menu (shown for three sources fitted)

The [*Appl'n Menu*] key accesses the *Applications Selection Menu* which enables you to select one of the three predefined applications. The [*Combiner Setup*] key accesses the *Combiner Setup Menu* which enables you to connect the signal sources in any combination to the combiner. The combined signal is then available at the COMBINED RF OUTPUT socket. [*Coupling Setup*] accesses the Frequency and Level Coupling menu which enables you to couple the B and C sources to the A source. These sources can then track the A source by means of a level offset and a frequency and harmonic offset.

Combiner setup

This facility allows the user to route an individual signal source (A, B or C) to either its designated separate RF OUTPUT connector or through the combiner to the COMBINED RF OUTPUT connector. The current routing of the signal sources is always indicated by the source field at the bottom of the display. If the sources are all routed to their separate connectors the combiner panel shows Σ not used.

Combiner selection

Select the required signal source – combiner configuration as follows:

- (1) On the *Setup Menu* press [*Combiner Setup*] to display the *Combiner Setup Menu*. This shows a graphical display of the current combiner setup similar to Fig. 4-2 below.

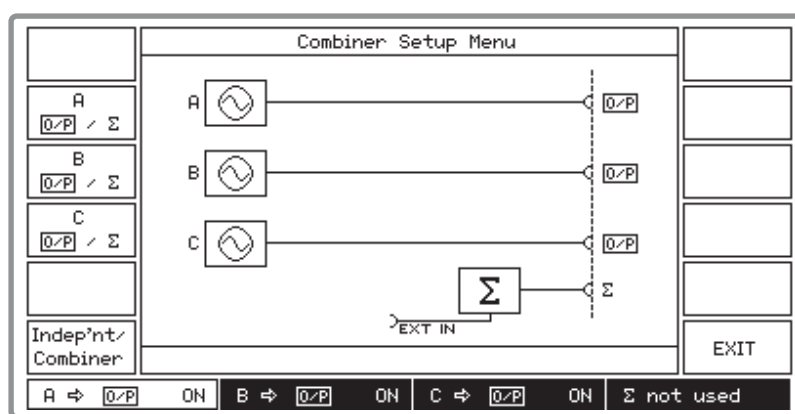

B3412

Fig. 4-2 Combiner setup menu

- (2) Pressing the [*O/P / Σ*]key for a particular source toggles between connecting the source to its own RF OUTPUT connector (shown by *O/P* on the display) or, via the combiner, to the COMBINED RF OUTPUT connector (shown by Σ). Use these keys to select your required configuration. As shown by the display, the EXT I/P socket is permanently connected to the combiner. But note that switching the C source to the combiner requires you to configure a rear-panel link (see 'External source' below).
- (3) At each change in configuration the A, B and C source panels and the combined output Σ panel at the bottom of the display change to show the new destinations. These settings are repeated on all menus.
- (4) Pressing the [*Indep't/Combiner*] key switches between the current configuration having a combiner output and all sources having independent outputs. This provides a convenient way to restore the sources to normal, independent operation.
- (5) Selecting [*EXIT*] returns you to the *Setup Menu*.

External source

Provision is made on the rear panel for connecting an external signal generator to the combiner via the EXT I/P connector.

For a generator fitted with three internal sources an additional connector, INT O/P, is fitted. The EXT I/P and INT O/P sockets effectively interrupt the C output to the combiner. To route the C source output to the combiner the two connectors are linked by the supplied coaxial jumper lead as shown in Fig. 4-3 below. To use an external source, remove the coaxial jumper lead using an SMA torque spanner and connect the external signal to the EXT I/P connector as shown in Fig. 4-2 above. When unused, always terminate the INT O/P connector by the attached 50 Ω load to prevent signal radiation from the C source.

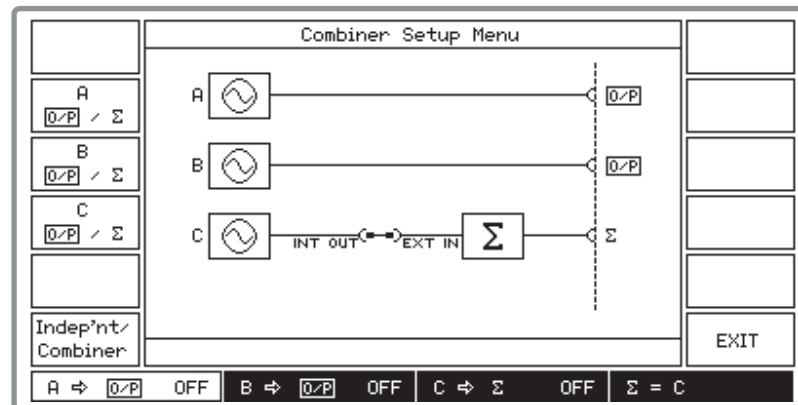

B3413

Fig. 4-3 Combiner setup menu, showing link between C source and combiner

For generators fitted with only two sources the INT O/P connector is not fitted and an external signal generator can be connected directly to the EXT I/P connector.

Coupling

Frequency and level coupling

Many measurements are made where it is convenient if the carrier frequencies and RF levels of signal sources are automatically related to each other. The coupling setup facility allows two or more signal sources to be coupled together in frequency and/or level. The frequencies can be coupled with a defined offset value (for example, 10.7 MHz), and can be harmonically related. The harmonic relationship is useful where a harmonic sampling gate or divider is being tested. RF levels can be entered in dB. Coupling factors of the B and C sources are always set relative to the A source.

The frequency coupling is entered in the form:

$$\text{Frequency (B)} = \text{frequency (A)} \times N + \text{offset frequency}$$

OR

$$\text{Frequency (B)} = \text{frequency (A)}/N + \text{offset frequency}$$

where N is an integer between 1 and 9

The B and C sources can be coupled only by entering their value relative to the A source. This means that if the offset frequency of B relative to A is set as +1 MHz, and C relative to A as +5 MHz, then C is always offset 4 MHz from B. For this reason, if a measurement requires two sources to be coupled they should be set as either A and B with C the independent source, or A and C with B the independent source. Offsets can have either positive or negative values.

Whenever a coupling factor has been set, the signal generator display clearly identifies the presence of coupling factors in the frequency or level display fields by displaying an icon of the form $\Rightarrow BC$ under the frequency/level units to indicate to which sources that parameter is currently coupled.

Coupling selection

To set the coupling factors proceed as follows:

- (1) On the *Setup Menu* press the [*Coupling Setup*] key to display the Frequency and Level Coupling menu (see Fig. 4-4 below). The screen is split horizontally into two, with the upper part displaying the frequency coupling parameters and the lower part displaying the level coupling parameters.

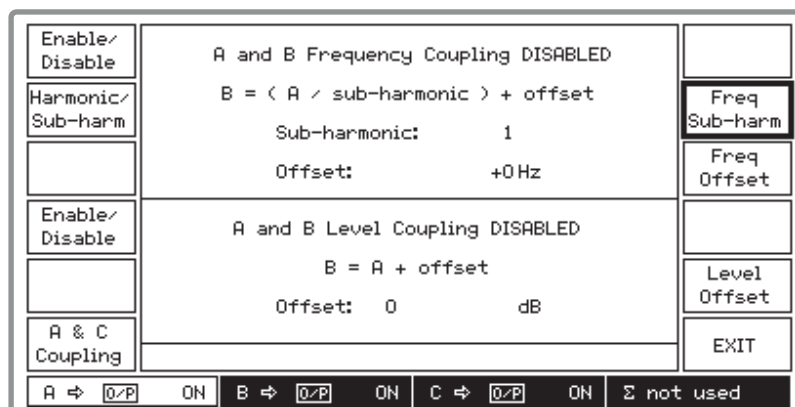

B3414

Fig. 4-4 Frequency and level coupling menu

Frequency

- (2) Select the required source by toggling between the *[A & B Coupling]* and *[A & C Coupling]* keys.
- (3) Select *[Freq Offset]* and enter the required offset from the A source, positive or negative, up to the instrument's maximum frequency and terminate with the [Hz], [kHz], [MHz] or [GHz] key.
- (4) To set the B or C source to a frequency which is a harmonic or sub-harmonic of the A source press the *[Harmonic/Sub-harm]* key. This key toggles the soft key selection between *[Freq Harmonic]* and *[Freq Sub-harm]*. Enter the required harmonic or sub-harmonic in the range 1 to 9 and terminate with any [ENTER] key.
- (5) If required, select a second source by repeating the above procedure.
- (6) Press *[Enable/Disable]* which toggles between the two states shown on the display. When *Enable* is selected, the Sig Gen menu is modified by the addition of an arrow and the letter for each coupled source in the frequency field. Thus $\Rightarrow B$, $\Rightarrow C$ or $\Rightarrow BC$ indicates that, in this case, the A source is coupled to the B source, the C source or both B and C sources.

Level

- (2) Select the required source by toggling between the *[A & B Coupling]* and *[A & C Coupling]* keys.
- (3) Select *[Level Offset]* and enter the required offset from the A source, positive or negative, and terminate with the [dB] key.
- (4) If required, select a second source by repeating steps (2) and (3) above.
- (5) Press *[Enable/Disable]* which toggles between the two states shown on the display. When *Enable* is selected, the Sig Gen Menu is modified by the addition of an arrow and the letter for each coupled source in the RF level field

Applications

Applications summary

The 2026 Multisource Generator supports a number of measurement applications which require more than one signal source to be coupled together. In addition to automatically selecting the most appropriate signal routing format, the applications mode also automatically couples the sources together and modifies the descriptions of the parameters entered to best suit the application. This considerably simplifies control of the sources and provides a clearer description of the measurement being performed.

Whenever an application is selected, the signal routing can be displayed in graphical form to ensure that the user understands how the sources are connected to the RF connectors. In addition, a stylized spectral diagram can be displayed which shows how the main control parameters are used in the test.

Some applications, such as 3-tone intermodulation measurements, cannot be performed using the internal sources of a generator fitted with only two sources. In these circumstances this is clearly indicated on the selection menu.

Applications selection

To select one of the predefined applications press the *[Appl'n Menu]* key on the *Setup Menu*. This causes the *Applications Selection Menu* (similar to that shown in Fig. 4-5) below to be displayed.

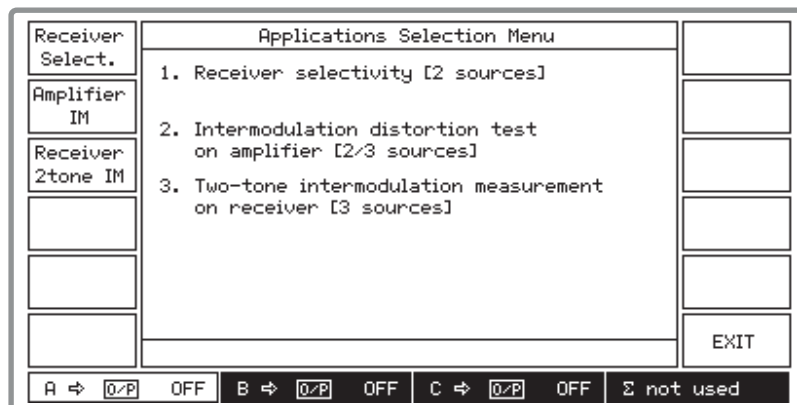

B3415

Fig. 4-5 Applications selection menu (shown for three sources fitted)

This menu enables you to perform two- and three-tone intermodulation distortion tests on an amplifier, make a two-tone intermodulation measurement on a receiver or carry out a receiver selectivity test. Intermodulation tests require the presence of one or two strong interfering signals whose intermodulation products fall in the receiver's or amplifier's input frequency band.

Note that when two sources are fitted the *[Receiver 2tone IM]* key does not appear so this test cannot be selected.

Amplifier intermodulation distortion application

Intermodulation tests on amplifiers are a good indication of the linearity of an amplifier. Many communication systems require devices able to carry two or more signals without introducing spurious frequencies which might affect system performance. The 2026 can support 2-tone and (if three sources are fitted) 3-tone intermodulation testing. The number of tones can also be increased by using the external source input, EXT I/P, for the connection of external generators.

Two-tone test

In this test two tones are input to an amplifier. Amplifier output will comprise not only the two applied tones but also, due to amplifier non-linearity, intermodulation products. One tone is provided from source A at the required amplifier frequency. The second interfering tone is provided from source B at a different frequency but same amplitude.

Three-tone test

In this test three tones are input to an amplifier. As described for the two-tone test above, the amplifier's non-linearity gives rise to distortion products. When these signals interfere with each other they will either add together to produce a larger amplitude signal or cancel each other depending on the phase of each signal.

The three tones used are: one at the centre frequency (from source A), and two additional, interfering signals (from sources B and C). To find the worst possible case for the amplifier, the phase of one of the signals must be adjusted until the distortion products rise to a maximum level. In the 2026 the peak levels can be identified by phase (or frequency) modulating source C and using a peak hold on the measuring instrument. Alternatively, the phase of source C can be adjusted (with no modulation applied) until a peak response is found.

When phase or frequency modulation is used to peak the measurement rate a default modulation rate of 10 Hz and deviation of 3.2 radians is provided. This can be adjusted by the user to suit the measuring instrument being used.

Procedure

You can carry out an intermodulation distortion test on an amplifier as follows:

- (1) Press [Amplifier IM] which displays the *Intermod. Distortion Test on Amplifier* block diagram as shown in Fig. 4-6 below.

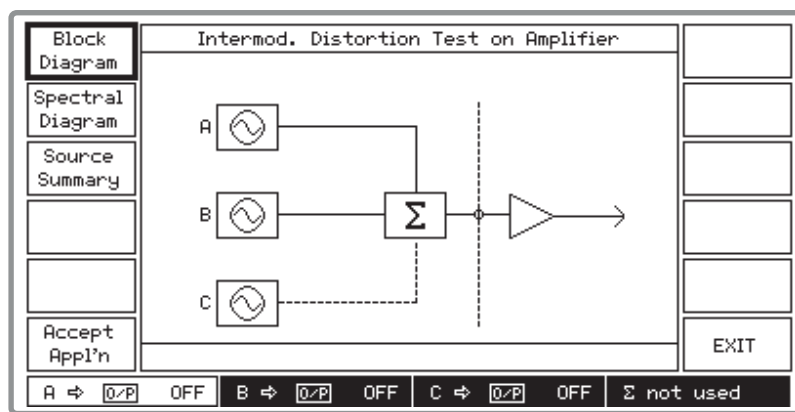

B3416

Fig. 4-6 Intermod. distortion test on amplifier block diagram

- (2) Connect the amplifier under test to the COMBINED RF OUTPUT socket as shown by the block diagram. Since for a 2-tone test the C source is not used, its connection to the combiner is shown dotted.

- (3) Press [Spectral Diagram] which displays the *Intermod. Distortion Test on Amplifier* spectral diagram as shown in Fig. 4-7 below.

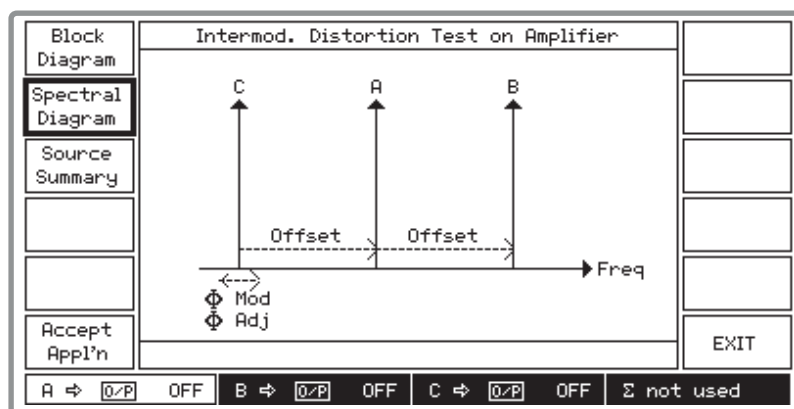

B3391

Fig. 4-7 Intermod. distortion test on amplifier spectral diagram

- (4) The spectral diagram shows the default setting with the B source offset higher in frequency than the A source (for a 2-tone test) and the C source offset lower in frequency than the A source (for a 3-tone test). You can reverse this setting so that the C source is at the higher frequency by entering a negative offset frequency. Also indicated on the diagram is the ability for you to additionally modulate and adjust the phase of the carrier of the C source for a 3-tone test. Also shown is that all signals have the same RF level.
- (5) If you wish to continue, press [Accept Appl'n] otherwise press [EXIT] which returns you to the *Applications Selection Menu* to enable you to select an alternative test.
- (6) Pressing [Accept Appl'n] displays the screen shown in Fig. 4-8 below. The screen is split horizontally into two, with the upper part displaying the receiver parameters and the lower part displaying the interferer offset frequency.

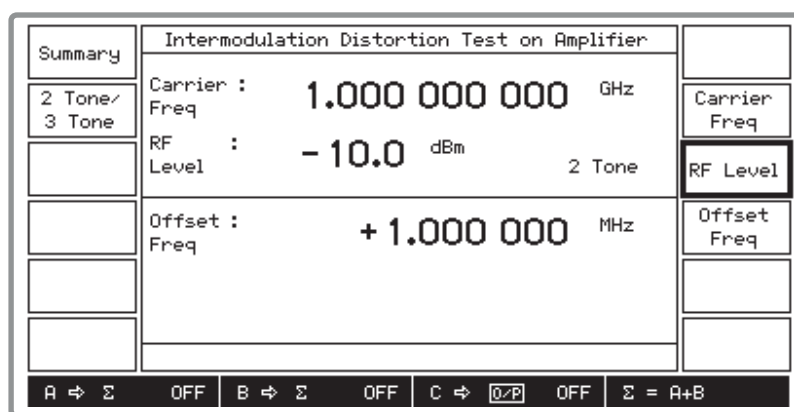

B3392

Fig. 4-8 Intermod. distortion test on amplifier: 2-tone selected

- (7) Select [Carrier Freq] and [RF Level] to set these parameters. The carrier frequency entered is that for the A source. The RF level entered is that for all sources, but note that the RF level limit is +4 dBm.
- (8) Select [Offset Freq] to change the equidistant offsets of the interferer B and C sources. You can reverse the relative positions of the B and C sources by entering a negative offset frequency.
- (9) Select 2 Tone or 3 Tone by pressing [2 Tone/3 Tone] to toggle between the two selections as shown on the screen.

(10) When you select 3 Tone four additional soft keys are displayed as shown in Fig. 4-9 below.

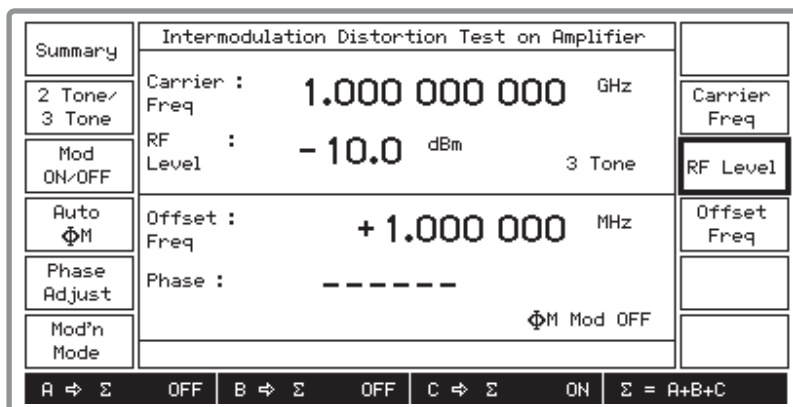

B3393

Fig. 4-9 Intermod. distortion test on amplifier: 3-tone selected

- (11) For 3-tone operation press the [Mod'n Mode] key to access the Modulation Setup Menu shown in Fig. 4-10 below. This enables you to apply modulation to the C source rather than select the [Auto φM] key. At the conclusion press [EXIT] to return to the previous screen.
- (12) Having selected the modulation in step (11) above, press [Mod ON/OFF] to toggle between the two states as shown by the screen.

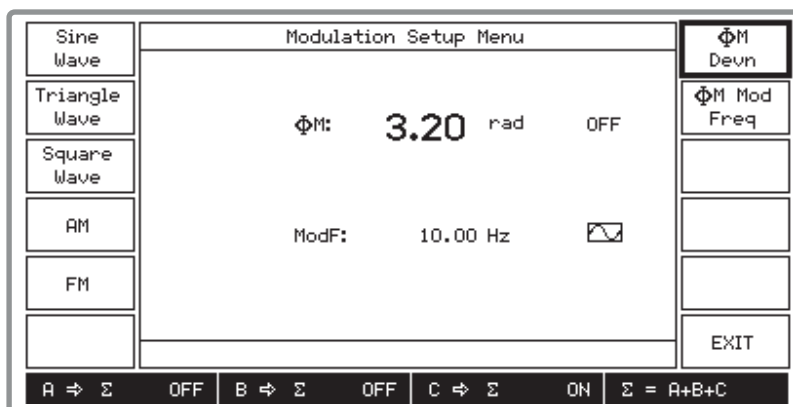

B3394

Fig. 4-10 Intermod. distortion test on amplifier: modulation setup menu, φM selected

- (13) For 3-tone operation pressing the [Auto φM] key enables you to automatically set the phase modulation of the C source. φM deviation is set to 3.20 rad at a modulation rate of 10 Hz sine wave. The low modulation rate ensures capture of the worst-case intermodulation products by the spectrum analyzer peak detector.
- (14) For 3-tone operation, by pressing [Phase Adjust] and using the control knob you can adjust the phase offset of the C source carrier with respect to its current phase for maximum distortion products. Turn clockwise to advance the phase and anticlockwise to retard the phase.
- (15) At any time during the test you can press [Summary] then [Source Summary] to display the Source Summary screen similar to that shown in Fig. 4-11 below. This shows the allocated frequencies and levels of all three sources to confirm your selection.

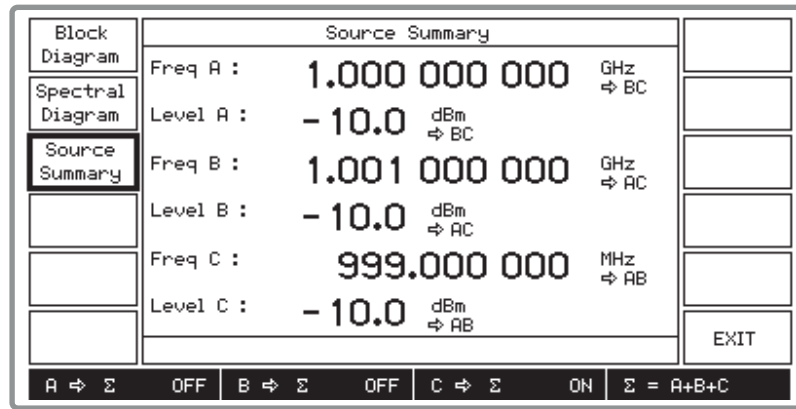

B3395

Fig. 4-11 Intermod. distortion test on amplifier: Source summary screen

- (16) At the conclusion of the test, press [EXIT] to return to the previous screen to continue with the application.
- (17) To choose another application or to cancel the current application and return to normal operation, press [SETUP]. This causes the Setup Menu shown in Fig. 4-12 below to be displayed. The screen is split horizontally in two, with the upper part displaying the application mode and the lower part displaying the application cancellation selection.

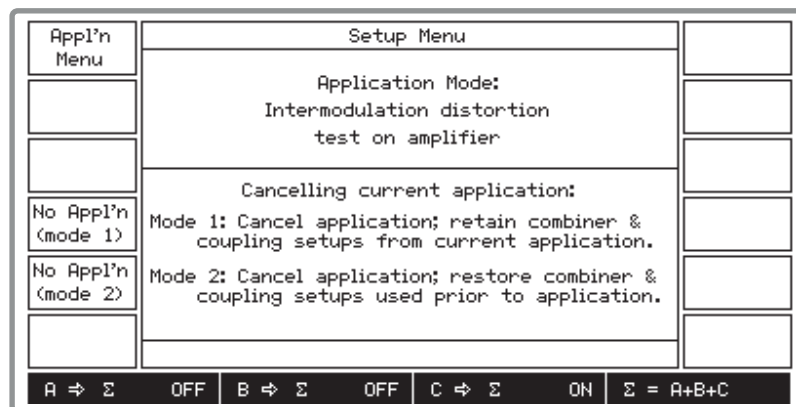

B3396

Fig. 4-12 Setup menu in application mode

- (18) To choose another application press [Appl'n Menu] which returns you to the Applications Selection Menu.
- (19) To cancel the current operation but retain the combiner and coupling setups, press [No Appl'n (mode 1)]. This enables you to leave the test temporarily, for example, to set the control knob to a different sensitivity for phase offset adjustment. To cancel the current operation but restore to the previous combiner and coupling setups press [No Appl'n (mode 2)]. Pressing either key returns you to the Setup Menu with no application selected as confirmed by the screen.

Receiver two-tone intermodulation application

When a receiver is demodulating a low level input signal, it is possible for two-high level out-of-band signals to generate intermodulation products in the receiver which interfere with the wanted signal. Receivers have to be tested for their susceptibility to such signals to ensure that the communication system is robust in adverse conditions.

To perform a receiver intermodulation test an in-channel wanted signal is applied to the receiver and two high-level signals are added to it so that their intermodulation products are at the receiver input frequency. Typically one of these high-level signals is modulated. This application allows both in-channel and interfering signals to be modulated.

Procedure

You can carry out a two-tone intermodulation test on a receiver as follows:

- (1) Press [Receiver 2tone IM] which displays the *Two-tone Intermod. Measurement on Receiver* block diagram as shown in Fig. 4-13 below.

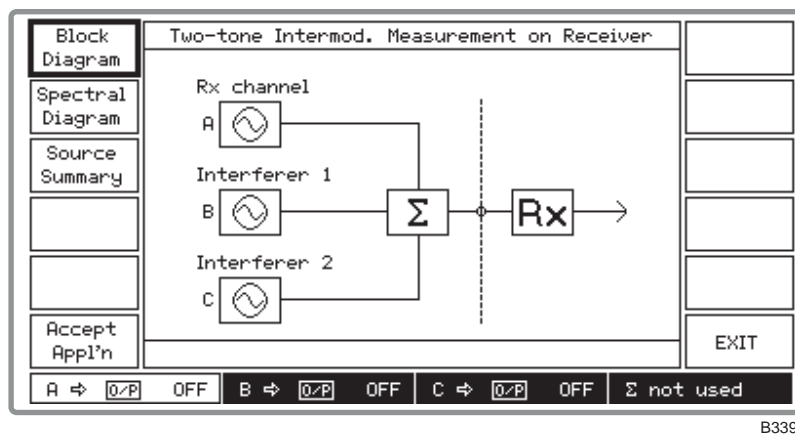

Fig. 4-13 Two-tone intermod. measurement on receiver block diagram

- (2) Connect the receiver under test to the COMBINED RF OUTPUT socket as shown by the block diagram.
- (3) Press [Spectral Diagram] which displays the *Two-tone Intermod. Measurement on Receiver* spectral diagram as shown in Fig. 4-14 below.

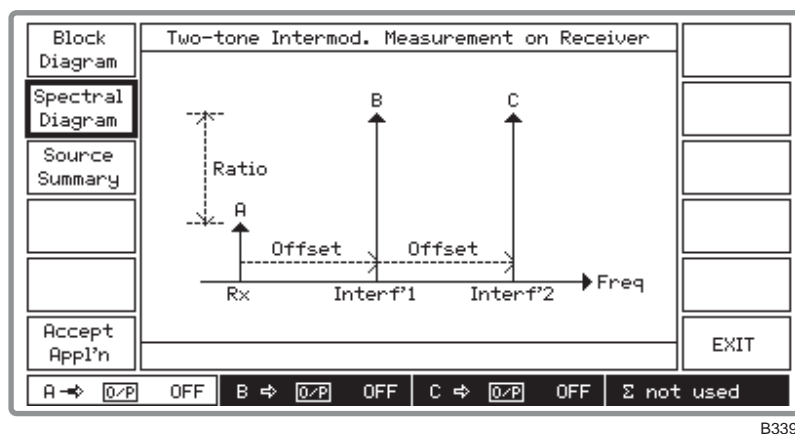

Fig. 4-14 Two-tone intermod. measurement on receiver: spectral diagram

- (4) The spectral diagram shows the default setting with the A source set to the receiver channel, the B source (interferer 1) offset higher in frequency than the A source, and the C source (interferer 2) set to twice that offset. You can reverse the positions of the B and C sources with respect to A so that the A source is at the higher frequency by entering a negative offset. The levels of the A, B and C sources are equally offset higher than the A source.
- (5) If you wish to continue, press *[Accept Appl'n]* otherwise press *[EXIT]* which returns you to the *Applications Selection Menu* to enable you to select an alternative test.
- (6) Pressing *[Accept Appl'n]* displays the screen shown in Fig. 4-15 below. The screen is split horizontally into two, with the upper part displaying the receiver parameters and the lower part displaying the interferer parameters. Note that in the signal source field at the bottom of the screen, the A, B and C sources are shown connected to the combiner by $\Sigma = A+B+C$.

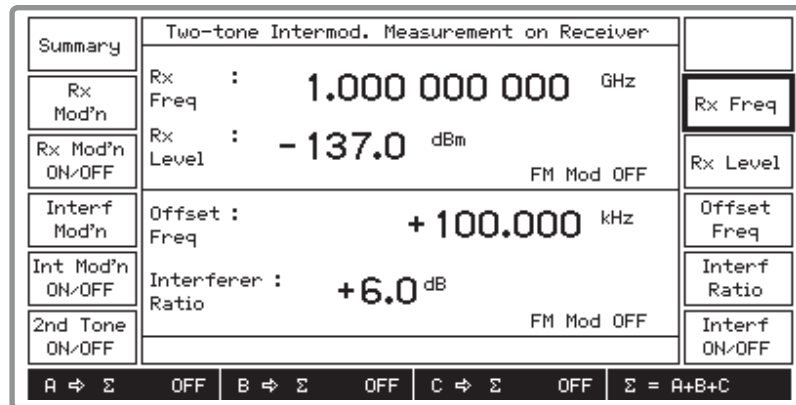

Fig. 4-15 Two-tone intermod. measurement on receiver: application accepted

- (7) Select *[Rx Freq]* and *[Rx Level]* to set these parameters for the A source. But note that the RF level limit is +4 dBm minus the interferer ratio (as shown by Fig. 4-14 above).
- (8) If you want to apply modulation to the A source, press the *[Rx Mod'n]* key to access the *Receiver Modulation Setup Menu* shown in Fig. 4-16 below. At the conclusion, press *[EXIT]* to return to the previous screen.

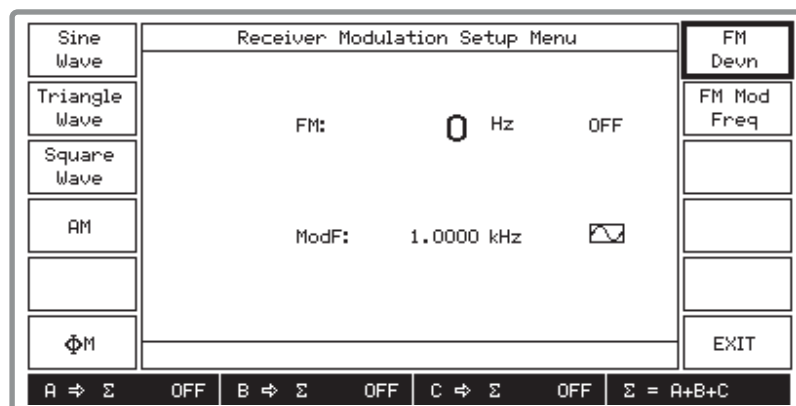
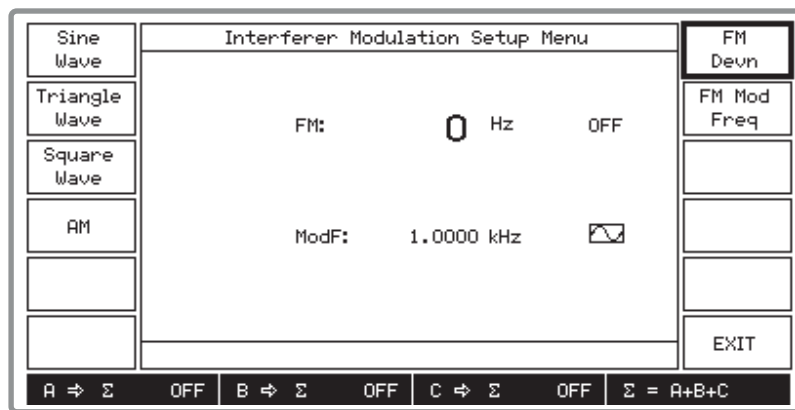

Fig. 4-16 Two-tone intermod. measurement on receiver: modulation setup menu

- (9) When the A source is modulated, press *[Rx Mod'n ON/OFF]* to toggle between the two states as shown by the screen.

- (10) Select *[Offset Freq]* to change the equidistant offsets of the B and C sources. You can reverse the relative positions of the B and C sources with respect to A by entering a negative offset frequency.
- (11) Set the interference ratio between the A source input level and the B and C source input levels by pressing *[Interf Ratio]* and entering the ratio in dB.
- (12) To apply modulation to the interferers (B and C sources) press the *[Interf Mod'n]* key to access the *Interferer Modulation Setup Menu* shown in Fig. 4-17 below. At the conclusion, press *[EXIT]* to return to the previous screen.



B3401

Fig. 4-17 Two-tone intermod. measurement on receiver: interferer mod setup menu

- (13) When the B and C sources are modulated, press *[Int Mod'n ON/OFF]* to toggle between the two states as shown by the screen.
- (14) Press *[2nd Tone ON/OFF]* to toggle the C source between the *ON* and *OFF* states as shown by the signal source field at the bottom of the screen. This facility enables you to check whether phase noise or selectivity is the predominant factor.
- (15) At any time during the test you can press *[Summary]* then *[Source Summary]* to display the *Source Summary* screen similar to that shown in Fig. 4-18 below. This shows the allocated frequencies and levels of all three sources to confirm your selection.

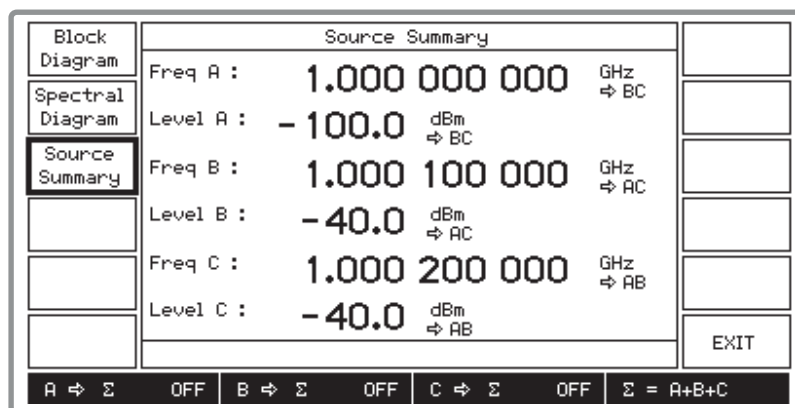

B3402

Fig. 4-18 Two-tone intermod. measurement on receiver: source summary

- (16) At the conclusion of the test, press *[EXIT]* to return to the previous screen to continue with the application.
- (17) To choose another application or to cancel the current application and return to normal operation, press *[SETUP]*. This causes the *Setup Menu* shown in Fig. 4-19 below to be

displayed. The screen is split horizontally in two, with the upper part displaying the application mode and the lower part displaying the application cancellation selection.

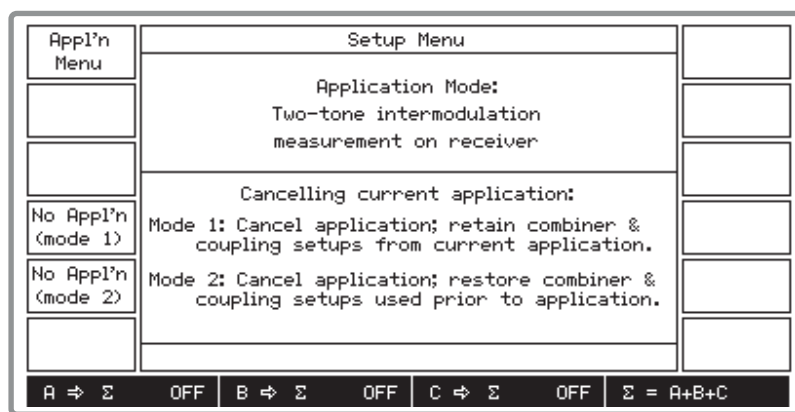

B3403

Fig. 4-19 Setup menu in application mode

- (18) To choose another application press [Appl'n Menu] which returns you to the Applications Selection Menu.
- (19) To cancel the current operation but retain the combiner and coupling setups, press [No Appl'n (mode 1)]. To cancel the current operation but restore to the previous combiner and coupling setups press [No Appl'n (mode 2)]. Pressing either key returns you to the Setup Menu with no application selected as confirmed by the screen.

Receiver selectivity application

The receiver selectivity test enables you to generate a modulated low-level RF signal to open a receiver and a second, much higher-level signal (with or without modulation) to interfere with the received signal. A facility is provided for you to increment, at a specified channel spacing, through the channels.

Procedure

- (1) Press [Receiver Select.] which displays the Receiver Selectivity block diagram as shown in Fig. 4-20 below.

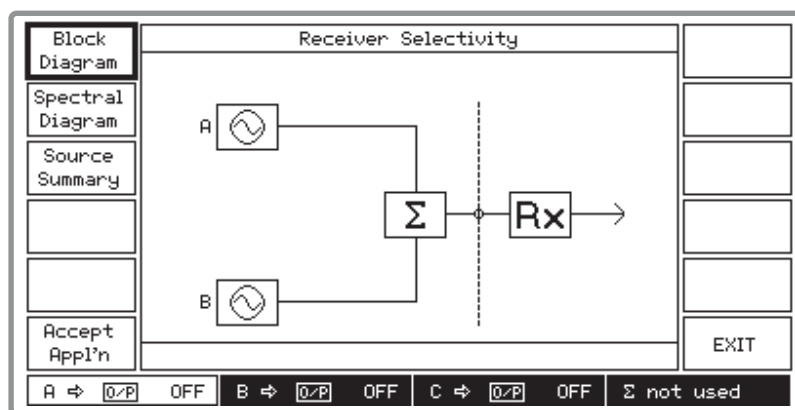

B3404

Fig. 4-20 Receiver selectivity block diagram

- (2) Connect the receiver under test to the COMBINED RF OUTPUT socket as shown by the block diagram.

- (3) Press [Spectral Diagram] which displays the Receiver Selectivity spectral diagram as shown in Fig. 4-21 below.

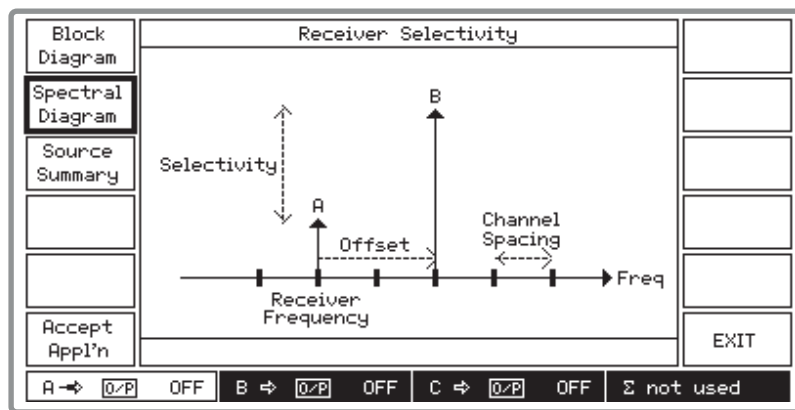

B3405

Fig. 4-21 Receiver selectivity spectral diagram

- (4) As shown by the spectral diagram, the A source is set to the receiver channel and the B source is offset higher in frequency than the A source at a multiple of the channel spacing. You can reverse this setting so that the B source is at the lower frequency by entering a negative offset. The B source is set higher in level than the A source.
- (5) If you wish to continue, press [Accept Appl'n], otherwise press [EXIT] which returns you to the Applications Selection Menu to enable you to select an alternative test.
- (6) Pressing [Accept Appl'n] displays a screen similar to that shown in Fig. 4-22 below. The screen is split horizontally into two, with the upper part displaying the receiver parameters and the lower part displaying the interferer parameters. Note that in the signal source field at the bottom of the screen, the A and B sources are shown connected to the combiner by $\Sigma = A+B$.

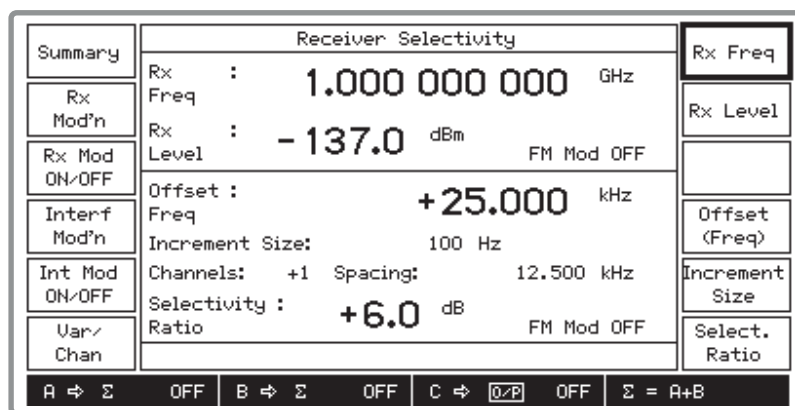

B3406

Fig. 4-22 Receiver selectivity: application accepted

- (7) Select [Rx Freq] and [Rx Level] if you want to change these parameters for the A source, but note that the RF level limit is +4 dBm when the selectivity ratio is set to 0 or to a negative value.
- (8) If you want to apply modulation to the A source press the [Rx Mod'n] key to access the Receiver Modulation Setup Menu shown in Fig. 4-23 below. At the conclusion press [EXIT] to return to the previous screen.

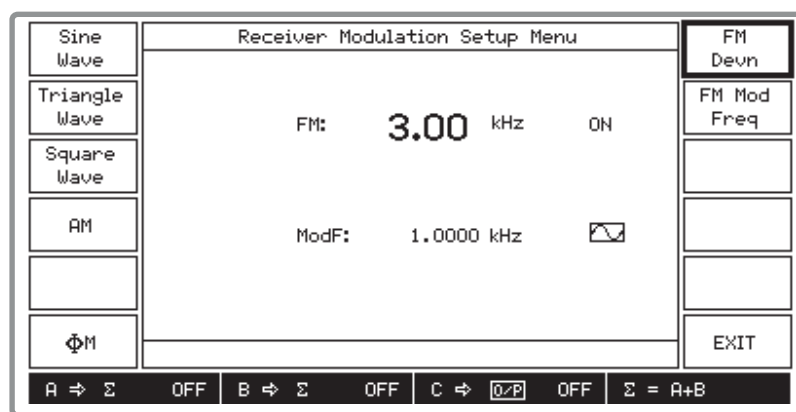

B3407

Fig. 4-23 Receiver selectivity: receiver modulation setup menu

- (9) When the A source is modulated press [*Rx Mod'n ON/OFF*] to toggle between the two states as shown by the screen.
- (10) If you want to apply modulation to the interferer (B source) press the [*Interf Mod'n*] key to access the *Interferer Modulation Setup Menu* shown in Fig. 4-24 below. At the conclusion press [*EXIT*] to return to the previous screen.

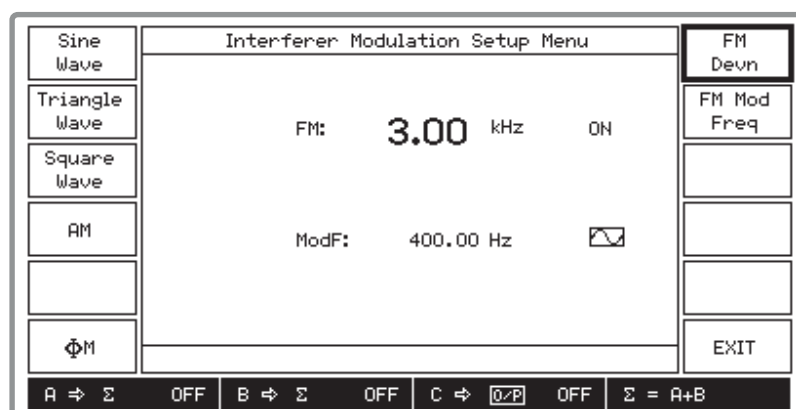

B3408

Fig. 4-24 Receiver selectivity: interferer modulation setup menu

- (11) When the B source is modulated, press [*Int Mod'n ON/OFF*] to toggle between the two states as shown by the screen.
- (12) To select channel mode, use the [*Var/Chan*] key which toggles between the variable and channel modes.
- (13) Press the [*Channel Spacing*] key and enter the channel spacing frequency using the keyboard.
- (14) Set the required interferer offset as a multiple of the channel frequency by pressing [*Offset (Channel)*] and entering the number on the keyboard. Entering a negative number sets the B source lower in frequency than the A source.
- (15) For a finer control of channel spacing and offset, select the variable mode by means of the [*Var/Chan*] key and use the [*Increment Size*] and [*Offset (Freq)*] keys which are now displayed. Entering a negative offset sets the B source lower in frequency than the A source.
- (16) Set the selectivity ratio (the amount by which the B source level is greater than the A source level) by pressing [*Select. Ratio*] and entering the ratio in dB.
- (17) At any time during the test you can press [*Summary*] then [*Source Summary*] to display the *Source Summary* screen similar to that shown in Fig. 4-25 below. This shows the allocated frequencies and levels of all three sources to confirm your selection.

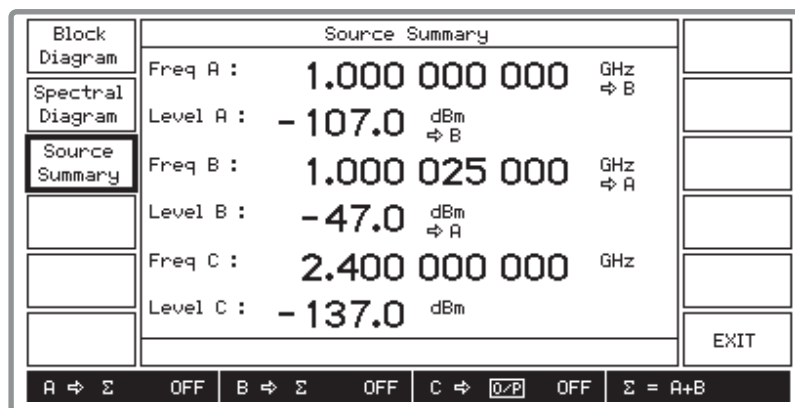

B3409

Fig. 4-25 Receiver selectivity: source summary

- (18) At the conclusion of the test, press [EXIT] to return to the previous screen to continue with the application.
- (19) To choose another application or to cancel the current application and return to normal operation, press [SETUP]. This causes the Setup Menu shown in Fig. 4-26 below to be displayed. The screen is split horizontally in two, with the upper part displaying the application mode and the lower part displaying the application cancellation selection.

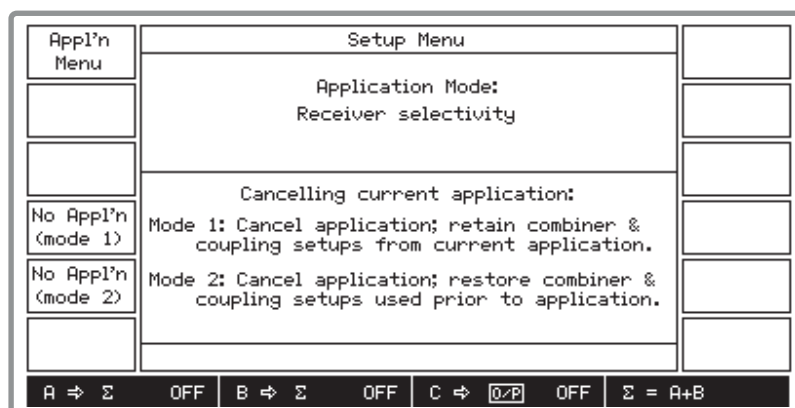

B3410

Fig. 4-26 Setup menu in application mode

- (20) To choose another application press [Appl'n Menu] which returns you to the Applications Selection Menu.
- (21) To cancel the current operation but retain the combiner and coupling setups, press [No Appl'n (mode 1)]. To cancel the current operation but restore to the previous combiner and coupling setups press [No Appl'n (mode 2)]. Pressing either key returns you to the Setup Menu with no application selected, as confirmed by the screen.

Chapter 5

REMOTE OPERATION

Contents

Preparing the instrument for remote operation	5-2
Introduction.....	5-2
Local lockout	5-2
Remote/local operation	5-2
Remote operation selection.....	5-2
RS-232 operation	5-3
RS-232 control port	5-3
Handshaking	5-3
Control characters	5-3
Setting RS-232 parameters	5-3
GPIB operation	5-4
GPIB control port	5-4
Setting GPIB address	5-4
GPIB functions	5-4
Device listening elements	5-5
Device talking elements	5-5
Programming.....	5-6
Program messages.....	5-6
Compound headers	5-6
Program data.....	5-7
Message exchange protocol	5-7
Remote/local operation	5-7
Common commands and queries (IEEE 488.2).....	5-7
Device-dependent commands	5-9
Default settings	5-9
Source selection	5-10
Combiner mode.....	5-10
Coupling (carrier frequency and RF level)	5-10
Carrier frequency (source-specific)	5-12
RF level (source-specific)	5-13
Modulation mode (source-specific)	5-14
Modulation control (source-specific).....	5-14
Frequency modulation (and FSK) (source-specific)	5-15
Phase modulation (source-specific)	5-17
Amplitude modulation (source-specific).....	5-19
Pulse modulation (source-specific).....	5-21
Memory – store	5-22
Memory – recall.....	5-22
Memory – erase	5-22
Memory – protection	5-23
Sweep operation.....	5-24
Sweep mode	5-24
Sweep control	5-25
Miscellaneous commands (source-specific)	5-26
Miscellaneous commands (not source-specific)	5-27
Status byte.....	5-30
Status data structure – register model	5-31
Standard event registers	5-32
Hardware event registers.....	5-33
Coupling event registers	5-34
Instrument event registers	5-35
Queue flag details	5-36
Status byte when read by *stb?	5-37
Status byte when read by serial poll.....	5-38
Summary of status reporting commands and queries.....	5-39

List of figures

Fig. 5-1 Remote control utility.....	5-2
--------------------------------------	-----

Preparing the instrument for remote operation

Introduction

The 2026 MultiSource Generator can be controlled remotely using either the RS_232 interface or the GPIB (General Purpose Interface Bus) interface. The command set used is designed to comply with IEEE 488.2. In RS_232 mode some IEEE 488.2 features are not implemented due to the restrictions of the interface.

Programs to control the instrument remotely over the two interfaces have much in common, the main difference being the way in which characters are transmitted.

Local lockout

In the remote mode the controller can set the instrument into Local Lockout state. When Local Lockout is set the front panel is disabled and the [LOCAL] key is made ineffective. This state is often used when the instrument is part of an automatic test system and left unattended. In this state the instrument cannot be affected by operation of the front panel. The keyboard can only be re_enabled by releasing Local Lockout over the remote interface or by switching the supply off and on again.

Remote/local operation

When the instrument is addressed by the GPIB controller it will enter its remote mode and the screen will display the [REM] annunciator at the lower right corner. Only one key, [Go To Local], will have any effect. Pressing this key returns the instrument to normal manual operation, unless Local Lockout (LLO) has been asserted by the controller.

When the instrument is addressed by the RS_232 controller, the remote mode is normally not entered (and thus no [REM] annunciator appears on the screen), although RS_232 operation is taking place.

In order to go to remote mode via the RS_232 it is necessary to transmit a control character (^A or 01H _ connect or go to remote) following which the [REM] annunciator appears. Subsequently pressing [Go To Local] or transmitting a control character (^D or 04H _ disconnect or go to local) will return the instrument to normal manual operation (unless Local Lockout has been asserted).

Remote operation selection

Remote operation can be selected between RS_232 and GPIB as follows:

- (1) Press [UTIL] to display the *Utilities Selection Menu 1* (if necessary, additionally press [Utils Menu 1]).
- (2) Press [Remote Control] to display the *Remote Control Utility* shown in Fig. 5_1 below.

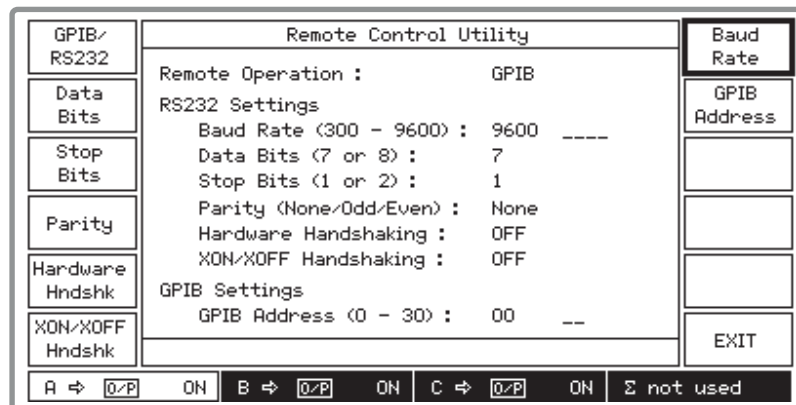

B3475

Fig. 5-1 Remote control utility

- (3) Select between GPIB and RS-232 operation by pressing the [GPIB/RS232] key which toggles between the two selections as shown by the screen.

RS-232 operation

RS-232 control port

The connections required between the RS-232 serial port and the controlling device are described in Chapter 2 under 'RS-232 interface'.

Handshaking

Software only

Flow control is achieved by XON/XOFF.

Note

All control lines are normally in the OFF state and are ignored.

Hardware only

Flow control is achieved DSR or CTS to suspend transmission from the instrument and using DTR to suspend transmission from the controller.

The instrument will continue to transmit for a few characters after receiving the command to stop transmission; the controller must have enough buffer space to cope with this extra data.

Note

The instrument will try to stop the controller from transmitting when the instrument's input buffer is nearly full and will allow further transmission when the buffer has enough room for new data.

Hardware and software

Normally used in conjunction with a modem. The flow control between the instrument and modem is achieved with the control lines, and the flow control to the remote control is achieved by XON/XOFF.

Control characters

The following list shows the control characters that are used over the RS-232 system to simulate certain features of the IEEE 488 interface:

- ^A (control A 01H) – connect or go to remote
- ^D (control D 04H) – disconnect or go to local
- ^R (control R 12H) – local lockout
- ^P (control P 10H) – release local lockout
- ^Q (control Q 11H) – XON char for software handshake
- ^S (control S 13H) – XOFF char for software handshake

Note that power on (PON) also clears the local lockout states.

Setting RS-232 parameters

With the *Remote Control Utility* shown in Fig. 5-1 above selected, proceed as follows:

- (1) Press [*Data Bits*] to toggle between 7 and 8 data bits.
- (2) Press [*Stop Bits*] to toggle between 1 and 2 stop bits.
- (3) Press [*Parity*] to cycle through the selections *None*, *Odd*, *Even*.
- (4) Press [*Hardware Hndshk*] and [*XON/XOFF Hndshk*] to select any combination between both *OFF* to both *ON*.

- (5) Press [*Baud Rate*] and set the baud rate in the range 300 to 9600 bit/s. But note that if the entered value is not one of the following standard settings, the next higher value will be selected by default.

300
600
1200
2400
4800
9600

GPIB operation

The instrument can be operated remotely from a personal computer fitted with a GPIB interface card or a dedicated GPIB controller. All functions can be controlled by coded messages sent over the interface bus via the 24-way socket on the rear panel of the instrument. IEEE Standard 488.2 (1992) is implemented, which defines the protocols and syntax of commands.

The instrument can function either as a talker or a listener. In the listen mode, it will respond to IEEE 488.2 common commands and queries and device-specific commands and queries. These allow various device functions to be controlled and operating parameters to be set. In the talk mode, device status information and parameter settings can be read from the instrument.

For full information on the IEEE protocols and syntax the IEEE 488.2 standard should be consulted.

GPIB control port

The connections required between the GPIB interface port and the controlling device are described in Chapter 2 under 'General Purpose Interface Bus (GPIB)'.

Setting GPIB address

The instrument must be given an address code before it can be used by remote control over the GPIB. With the *Remote Control Utility* shown in Fig. 5-1 above selected, proceed as follows:

- (1) Press [*GPIB Address*] and enter the address which must be unique on the system to the instrument and within the range 0 to 30.

GPIB functions

The IEEE 488.1 interface functions offered by the 2026 MultiSource Generator are as follows:

Source handshake (SH1)	complete capability.
Acceptor handshake (AH1)	complete capability.
Talker (T6)	basic talker, serial poll, unaddress if MLA.
Listener (L4)	basic listener, unaddress if MTA.
Service Request (SR1)	complete capability.
Remote/Local (RL1)	complete capability.
Device clear (DC1)	complete capability.
Device trigger (DT1)	complete capability.
Parallel Poll (PP0)	no capability.
Controller (C0)	no capability.
Tri-state drivers (E2)	as opposed to open collector drivers.

Device listening elements

The following is a list of the device listening elements (as defined in the IEEE 488.2 standard) which are used in the instrument:

- <PROGRAM MESSAGE>
- <PROGRAM MESSAGE TERMINATOR>
- <PROGRAM MESSAGE UNIT>
- <PROGRAM MESSAGE UNIT SEPARATOR>
- <COMMAND MESSAGE UNIT>
- <QUERY MESSAGE UNIT>
- <COMPOUND COMMAND PROGRAM HEADER>
- <COMPOUND QUERY PROGRAM HEADER>
- <PROGRAM HEADER SEPARATOR>
- <PROGRAM DATA>
- <PROGRAM DATA SEPARATOR>
- <DECIMAL NUMERIC PROGRAM DATA>
- <CHARACTER PROGRAM DATA>
- <SUFFIX PROGRAM DATA>
- <STRING PROGRAM DATA>
- <ARBITRARY BLOCK PROGRAM DATA>

Device talking elements

The following is a list of the device talking elements (as defined in the IEEE 488.2 standard) which are used in the instrument:

- <RESPONSE MESSAGE>
- <RESPONSE MESSAGE TERMINATOR>
- <RESPONSE MESSAGE UNIT>
- <RESPONSE MESSAGE UNIT SEPARATOR>
- <COMPOUND RESPONSE HEADER>
- <RESPONSE HEADER SEPARATOR>
- <RESPONSE DATA>
- <RESPONSE DATA SEPARATOR>
- <NR1 NUMERIC RESPONSE DATA>
- <NR2 NUMERIC RESPONSE DATA>
- <ARBITRARY ASCII RESPONSE DATA>
- <CHARACTER RESPONSE DATA>
- <STRING RESPONSE DATA>
- <DEFINITE LENGTH ARBITRARY BLOCK RESPONSE DATA>

Programming

Program messages

A message consists of one or more message units. Message units are separated by a semi-colon (;). The whole message is ended by the Program Message Terminator (or End Of Message) defined as one of the following:

- (1) <newline> (ASCII 10 – often known as ‘line feed’) or
- (2) <newline> + END (the EOI line is asserted as well) or
- (3) + END (EOI is asserted in the last data byte of the message)

Note

A response message is always terminated by <EOM> consisting of <newline> + END.

A message unit consists of a mnemonic header which may be followed by data. If data follows, it must be separated from its header by at least one space:

```
<header><SPACE><data>
for example, RFLV:INC 6.0 dB
```

Spaces may be freely inserted in a message to improve readability, except within a header or within data.

A header may be a command or a query. A query has a ‘?’ as its final character and causes the generation of a response message which will be read by the controller. Common commands and queries (defined in IEEE 488.2) begin with a ‘*’.

Upper and lower case characters are considered equivalent (so FM, fm, Fm, fM are all interpreted by the instrument in the same way).

Compound headers

The instrument implements compound headers which allows a complex set of commands to be built up from a small set of basic elements in a ‘tree and branch’ structure. The elements of a compound header are separated by a colon (:). Spaces are not allowed within a header.

Special rules apply when more than one compound header is used in one message. When the separator ‘;’ is encountered, all headers except the trailing element of the previous header in the message are assumed to precede the following header, for example:

```
AM:DEPTH 30PCT;ON
```

is equivalent to the two commands:

```
AM:DEPTH 30PCT
and AM:ON
```

This does not apply to common commands (*RST etc.). The rule may be overridden by preceding a header with a colon, for example:

```
AM:ON::FM:ON
```

Most main functions have a short form of header which may be used for clarity and brevity in simple messages, for example:

```
CFRQ 1.25GHZ is the same as CFRQ:VALUE 1.25GHZ
```

Program data

Data can take many forms, as follows:

Decimal Numeric Data is a flexible numeric format which encompasses integer, fixed point and floating point (mantissa and exponent) representations. Data is rounded to a resolution appropriate to the function. Decimal data can, in most cases, be followed by the appropriate units. If no units are present, the specified default units are assumed.

Character Data is an alphanumeric word.

String Data consists of a number of 7-bit ASCII characters enclosed in quotes; either a pair of single ('ASCII 39') or double ("ASCII 34") quotes may be used.

Some commands can accept Multiple Data items which are separated by commas, for example MODE FM,AM.

Message exchange protocol

The controller should not attempt to read a response until it has sent the entire query message (terminated by EOM). Also, it should not start to send a new message until it has read the entire response (terminated by EOM). The query message may contain more than one query message unit, but only one response message (containing several response message units) is generated.

Failure to follow the protocol will generate a query error:

INTERRUPTED (error 450) occurs when the controller starts to send a new message before having read the response to a preceding query.

UNTERMINATED (error 451) occurs when the controller attempts to read a response without having sent a query.

DEADLOCK (error 452) can only occur if the input and output buffers are both filled by the controller having sent an extra long message containing several query message units.

These instruments have an input buffer of 256 characters and an output buffer of 256 characters.

Remote/local operation

When the instrument is addressed by the controller it will enter its remote mode and the screen will display the *[REM]* annunciator. Only one key, the softkey *[Go To Local]*, will have any effect. Pressing this key returns the unit to normal manual operation, unless Local Lockout has been asserted by the controller.

Common commands and queries (IEEE 488.2)

The IEEE 488.2 standard defines a set of common commands and queries which implement common system functions.

Common command and query mnemonics are preceded by an asterisk (*) to distinguish them from device-dependent data such as instrument programming strings. The following common commands and queries are implemented in the instrument:

Mnemonic	Name and Description
*IDN?	<p>Identification Query. Returns an arbitrary ASCII response comprising four data fields in the format:</p> <p style="padding-left: 20px;"><manufacturer>,<model>,<serial number>,<software part number and issue number>.</p> <p>where: <manufacturer> is IFR, <model> is the instrument model number, which is 2026. <serial number> is the instrument serial number in the form nnnnn/nnn, where n is an ASCII digit in the range 0 to 9. <software part number and issue number> is in the form nnnnn/nnn/nn.nn, where n is an ASCII digit in the range 0 to 9.</p> <p>Example: IFR, 2026, 811182/111, 44533/222/01.00<EOM></p> <p>Option Identification Query. Returns an arbitrary ASCII response containing a data field for each fitted option in the format:</p> <p style="padding-left: 20px;"><option a>,<option b>, ... ,<option n><EOM></p> <p>Option 1: 3 SOURCE GENERATOR Option 3: HIGH STABILITY OCXO Option 4: REAR PANEL CONNECTORS</p> <p>If no options are fitted, ASCII '0' is returned..</p> <p>Example: 3 SOURCE GENERATOR,HIGH STABILITY OCXO<EOM></p>

Note

Because an Arbitrary ASCII Response ends with the Response Message Terminator (<EOM>) either *IDN? or *OPT? must be the last Query Message Unit in a Program Message.

*RST	Reset Command. Sets the instrument functions to the factory default power up state.
*TST?	Self Test Query. Returns a '0' when the GPIB interface and processor are operating.
*OPC	Operation Complete Command. Sets the Operation Complete bit in the Standard Event Status Register when execution of the preceding operation is complete.
*OPC?	Operation Complete Query. Returns a '1' when the preceding operation has been completed.
*WAI	Wait to Continue Command. Inhibits execution of an overlapped command until the execution of the preceding operation has been completed.
*TRG	Trigger Command. Equivalent to Group Execute Trigger.
*STB?	Read Status Byte Query. Returns the value of the Status Byte as an nr1 number (0–255).
*SRE <nrf>	Service Request Enable Command. Sets the Service Request Enable Register.
*SRE?	Service Request Enable Query. Returns the value of the Service Request Enable Register as nr1.
*ESR?	Standard Event Status Register Query. Returns the value of the Status Event Status Register as nr1.
*ESE <nrf>	Standard Event Status Enable Command. Sets the Standard Event Enable Register.
*ESE?	Standard Event Status Enable Query. Returns the value of the Standard Event Status Enable Register as nr1.
*CLS	Clear Status Command. Clears all the Status Event registers and clears the Error Queue. Does not affect the Enable Registers.

Device-dependent commands

The following list describes the features of the device-dependent mnemonics for the instrument together with simple examples of their use within each major section (Carrier frequency, RF level, etc.) The root mnemonic is listed first followed by the lower level mnemonics. Each group is followed by a list of requirements for data type and suffix.

In addition to the normal listen commands the instrument accepts query commands which cause it to prepare a message which will be sent to the controller when the instrument is next addressed to talk. For each query an example of a response is given. Where responses are similar for a group of queries not all are listed. Some queries can produce more than one type of response – an example of each is usually given.

In the list which follows, the abbreviations <char>, <nrf> and <str> have the following meanings:

<char>	=	Character Program Data
<nrf>	=	Decimal Numeric Program Data
<str>	=	String Program Data

Where the data format is Decimal Numeric Program Data, the value may be expressed as a signed or unsigned number in any of the following formats:

nr1:	Decimal integer: for example, 1234 or -567
nr2:	Floating point number: for example, 1.234 or -56.789
nr3:	Floating point number with exponent: for example, 1.2345E5 or -12.47E-8

Default settings

These are the settings assigned to instrument functions in the following cases:

- (i) Power-up to factory default settings.
- (ii) Execution of *RST command.
- (iii) Pressing [*Factory Recall*] on the *Memory Recall Menu*.

Source selection

SOURCE Select RF Source A, B or C as current source. When a source is selected, the source-specific commands and queries will then apply to that source.

Data type : Character Program Data (A, B or C)
 Allowed suffices : None
 Default suffix : None

SOURCE? Prepares message containing information on the current RF Source selection in the following format:

:SOURCE <mode>

where: <mode> is character program data indicating the current source (A, B or C).

Example: :SOURCE B

Combiner mode

CMODE Set the combined output mode. The combinations are as follows:
 (where A, B and C refer to sources A, B and C respectively)
 A+B, B+C, A+C, A+B+C, A, B, C, OFF

Data type : Character Program Data (A, B, C, AB, BC, AC, ABC, OFF)
 Allowed suffices : None
 Default suffix : None

Examples: CMODE ABC

CMODE? Prepares message containing information on the combined output mode setting in the following format:

:CMODE <mode>

Example: :CMODE ABC

Coupling (carrier frequency and RF level)

COUPLING [not used alone]

:MODE Set coupling mode

Data type : Character Program Data (combinations of CFRQAB, CFRQAC, RFLVAB and RFLVAC, or DISABLED. See table below.)
 Allowed suffices : None
 Default suffix : None

VALID COUPLING MODES

CFRQAB : Enable Carrier Frequency coupling between sources A and B.
 CFRQAC : Enable Carrier Frequency coupling between sources A and C.
 RFLVAB : Enable RF Level coupling between sources A and B.
 RFLVAC : Enable RF Level coupling between sources A and C.
 DISABLED : Disable all coupling.
 Note: Order is not important, for example CFRQAC, RFLVAB is equivalent to RFLVAB, CFRQAC.

:CFRQAB or :CFRQAC

:MODE Select HARMonic or SUBHARMonic relationship

Data type : Character Program Data (either HARM or SUBHARM)

Allowed suffices : None
 Default suffix : None

:HARM Set Harmonic for carrier frequency coupling relationship

:SUBHARM Set Sub-harmonic for carrier frequency coupling relationship

Data type : Decimal Numeric Program Data
 Allowed suffices : None
 Default suffix : None

:OFFSET Set Frequency Offset for carrier frequency coupling relationship

Data type : Decimal Numeric Program Data
 Allowed suffices : Any one of: GHZ, MHZ, KHZ or HZ
 Default suffix : HZ

:RFLVAB or :RFLVAC

:OFFSET Set Level Offset for RF Level coupling relationship

Data type : Decimal Numeric Program Data
 Allowed suffices : DB
 Default suffix : DB

COUPLING? Prepares message containing information on the Coupling Mode in the following format:
 :COUPLING:MODE <mode>
 where: <mode> is character program data indicating the coupling mode selections.

Example: : COUPLING : MODE CFRQAC , RFLVAC

**COUPLING:CFRQAB? or
 COUPLING:CFRQAC?** Prepares message containing information on the carrier frequency coupling relationship in one of the following formats:
 :COUPLING:CFRQAB:MODE <mode>;HARM <nr1>;SUBHARM <nr1>;OFFSET <nr2>

 :COUPLING:CFRQAC:MODE <mode>;HARM <nr1>;SUBHARM <nr1>;OFFSET <nr2>

 where: <mode> is character program data indicating HARMonic or SUBHARMonic selection.

Example: : COUPLING : CFRQAC : MODE SUBHARM ; HARM 2 ; SUBHARM 6 ;
 OFFSET 20000.0

**COUPLING:RFLVAB? or
 COUPLING:RFLVAC?** Prepares message containing information on the RF level coupling relationship in one of the following formats:
 :COUPLING:RFLVAB:OFFSET <nr2>
 :COUPLING:RFLVAC:OFFSET <nr2>

Example: : COUPLING : RFLVAB : OFFSET 3.5

Carrier frequency (source-specific)

CFRQ	Set Carrier Frequency (short form)
:VALUE	Set Carrier Frequency
:INC	Set Carrier Frequency step
	Data type : Decimal Numeric Program Data
	Allowed suffices : Any one of: GHZ, MHZ, KHZ or HZ
	Default suffix : HZ
:UP	Go UP one step
:DN	Go DOWN one step
:RETN	Return to original setting
:XFER	Transfer current value to be the new setting
	Data type : None
	Allowed suffices : None
	Default suffix : None
:PHASE	Adjust Phase Offset of Carrier in degrees
	Data type : Decimal Numeric Program Data
	Allowed suffices : DEG
	Default suffix : DEG
	Examples: CFRQ:VALUE 2.54MHZ;INC 10KHZ CFRQ:UP;XFER
CFRQ?	Prepares message containing information on Carrier Frequency setting in the following format: :CFRQ:VALUE <nr2>;INC <nr2>
	Example: :CFRQ:VALUE 1000000000.0;INC 25000.0

RF level (source-specific)

RFLV	Set RF Output Level (short form)
:VALUE	Set RF Output Level
	Data type : Decimal Numeric Program Data
	Allowed suffices : Any one of: DBM, DBV, DBMV, DBUV, V, MV, UV OR NV.
	Default suffix : DBM unless changed by UNITS command
:INC	Set RF Level step (dB)
	Data type : Decimal Numeric Program Data
	Allowed suffices : DB only
	Default suffix : DB
:UP	Go UP one step
:DN	Go DOWN one step
:RETN	Return to original setting
:XFER	Transfer current value to be the new setting
:ON	Turn RF Output ON
:OFF	Turn RF Output OFF
	Data type : None
	Allowed suffices : None
	Default suffix : None
:TYPE	Selects EMF or PD for voltage related units
	Data type : Character Program Data (EMF or PD)
	Allowed suffices : None
	Default suffix : None
:UNITS	Select default RF level units.
	Data type : Character Program Data (DBM, DBV, DBMV, DBUV, V, MV or UV)
	Allowed suffices : None
	Default suffix : None
	Examples: RFLV:VALUE -27.3DBM;ON RFLV:TYPE PD;VALUE 1.23UV
RFLV?	Prepares message containing information on RF Level setting in the following format: :RFLV:UNITS <unit>;TYPE <type>;VALUE <nr2>;INC <nr2>;<status>
	where: <unit> is character program data defining the default RF level units (DBM, DBV, DBMV, DBUV, V, MV or UV), <type> is character program data indicating EMF or PD and <status> is a program mnemonic indicating whether the RF output is ON or OFF
	Examples: :RFLV:UNITS DBM;TYPE PD;VALUE -103.5;INC 2.0;ON :RFLV:UNITS DBV;TYPE EMF;VALUE -83.2;INC 0.5;ON

Modulation mode (source-specific)

MODE Set modulation mode

Data type : Character Program Data (valid combinations of AM, FM, PM, FSK2L, FSK4L or PULSE. See table below.)

Allowed suffices : None

Default suffix : None

Examples: MODE AM, FM
MODE FM, PULSE

VALID MODE COMBINATIONS TABLE

AM [,PULSE]
 FM [,PULSE]
 PM [,PULSE]
 AM,FM [,PULSE]
 AM,PM [,PULSE]
 FSK2L [,PULSE]
 FSK4L [,PULSE]

Note...

Order is not important, for example AM,FM is equivalent to FM,AM. Pulse modulation can be used with any of the AM,FM,PM,FSK2L and FSK4L modes.

FSK2L and FSK4L parameters are controlled using the FM commands

MODE? Prepares message containing information on Modulation Mode in the following format:
 :MODE <mode>
 where: <mode> is character program data indicating the modulation mode settings

Example: :MODE AM, FM

Modulation control (source-specific)

MOD [not used alone]

:ON Turn modulation globally ON

:OFF Turn modulation globally OFF

Examples: MOD : ON
MOD : OFF

MOD? Prepares message containing information on Modulation Control in the following format:
 :MOD:<status>
 where: <status> is a program mnemonic indicating whether the Modulation is globally ON or OFF

Example: :MOD : ON

Frequency modulation (and FSK) (source-specific)

FM or FM1 or FM2	Set FM Deviation (short form)
:DEVN	Set FM Deviation
:INC	Set FM step size
	Data type : Decimal Numeric Program Data
	Allowed suffices : Any one of: GHZ, MHZ, KHZ or HZ
	Default suffix : HZ
:<src>	Select modulation source where <src> is any one of: INT, EXTAC, EXTALC, or EXTDC
:ON	Turn FM ON (locally)
:OFF	Turn FM OFF (locally)
:UP	Go UP one step
:DN	Go DOWN one step
:RETN	Return to original setting
:XFER	Transfer current value to be the new setting
	Data type : None
	Allowed suffices : None
	Default suffix : None
	Examples: FM:DEVN 25KHZ;INT;ON
	FM1:DEVN 15KHZ;INC 1KHZ;EXTDC
:MODF	Set FM modulation oscillator frequency (short form)
:VALUE	Set FM modulation oscillator frequency
:INC	Set FM modulation oscillator frequency step size
	Data type : Decimal Numeric Program Data
	Allowed suffices : Any one of: GHZ, MHZ, KHZ or HZ
	Default suffix : HZ
:UP	Go UP one step
:DN	Go DOWN one step
:RETN	Return to original setting
:XFER	Transfer current value to be the new setting
:SIN	Select sinusoidal waveform
:TRI	Select triangle waveform
:SQR	Select square waveform
	Data type : None
	Allowed suffices : None
	Default suffix : None
:PHASE	Set phase offset of modulation oscillator relative to current phase
	Data type : Decimal Numeric Program Data
	Allowed suffices : DEG
	Default suffix : DEG
	Examples: FM2:MODF:VALUE 1.5KHZ;SIN
	FM:MODF:PHASE 1.2DEG

DCFMNL

Perform DC FM null operation

Data type : None
Allowed suffices : None
Default suffix : None

Example: DCFMNL

FM? or FM1? or FM2?

Prepares message containing information on FM setting in one of the following formats:

:FM:DEVN <nr2>;<src>;<status>;INC <nr2>

:FM1:DEVN <nr2>;<src>;<status>;INC <nr2>

:FM2:DEVN <nr2>;<src>;<status>;INC <nr2>

where: <src> is a program mnemonic representing the source of the modulation signal and <status> is a program mnemonic indicating whether the frequency modulation is locally ON or OFF

Example: :FM1:DEVN 25000.0;INT;ON;INC 1000.0

FM:MODF? or FM1:MODF? or FM2:MODF?

Prepares message containing information on FM modulation oscillator setting in one of the following formats:

:FM:MODF:VALUE <nr2>;<shape>;INC <nr2>

:FM1:MODF:VALUE <nr2>;<shape>;INC <nr2>

:FM2:MODF:VALUE <nr2>;<shape>;INC <nr2>

where: <shape> is a program mnemonic representing the waveform shape

Example: :FM1:MODF:VALUE 5750.00;SIN;INC 1000.00

Phase modulation (source-specific)

PM or PM1 or PM2

	Set Phase Modulation Deviation (short form)
:DEVN	Set Phase Modulation Deviation
:INC	Set Phase Modulation step size
	Data type : Decimal Numeric Program Data
	Allowed suffices : RAD
	Default suffix : RAD
:<src>	Select modulation source where <src> is any one of: INT, EXTAC, EXTALC, or EXTDC
:ON	Turn PM ON (locally)
:OFF	Turn PM OFF (locally)
:UP	Go UP one step
:DN	Go DOWN one step
:RETN	Return to original setting
:XFER	Transfer current value to be the new setting

Data type : None
 Allowed suffices : None
 Default suffix : None

Examples: PM:DEVN 2.38RAD;INT;ON
 PM1:DEVN 1.5RAD;INC 0.1RAD;EXTAC

:MODF	Set PM modulation oscillator frequency (short form)
:VALUE	Set PM modulation oscillator frequency
:INC	Set PM modulation oscillator frequency step size

Data type : Decimal Numeric Program Data
 Allowed suffices : Any one of: GHZ, MHZ, KHZ or HZ
 Default suffix : HZ

:UP	Go UP one step
:DN	Go DOWN one step
:RETN	Return to original setting
:XFER	Transfer current value to be the new setting
:SIN	Select sinusoidal waveform
:TRI	Select triangle waveform
:SQR	Select square waveform

Data type : None
 Allowed suffices : None
 Default suffix : None

:PHASE	Set phase offset of modulation oscillator relative to current phase
--------	---

Examples: PM1:MODF:VALUE 10.5KHZ;SQR
 PM2:MODF:PHASE 2.0DEG

PM? or PM1? or PM2?

Prepares message containing information on Phase Modulation setting in one of the following formats:

```
:PM:DEVN <nr2>;<src>;<status>;INC <nr2>
:PM1:DEVN <nr2>;<src>;<status>;INC <nr2>
:PM2:DEVN <nr2>;<src>;<status>;INC <nr2>
```

where <src> is a program mnemonic representing the source of the modulation signal and <status> is a program mnemonic indicating whether the phase modulation is locally ON or OFF

Example: :PM2:DEVN 2.30;INT;OFF;INC 0.05

**PM:MODF? or PM1:MODF?
or PM2:MODF?**

Prepares message containing information on PM modulation oscillator setting
in one of the following formats:

:PM:MODF:VALUE <nr2>;<shape>;INC <nr2>

:PM1:MODF:VALUE <nr2>;<shape>;INC <nr2>

:PM2:MODF:VALUE <nr2>;<shape>;INC <nr2>

where: <shape> is a program mnemonic representing the waveform
shape

Example: :PM2:MODF:VALUE 2500.00;TRI;INC 500.00

Amplitude modulation (source-specific)

AM or AM1 or AM2	Set AM Depth (short form)
:DEPTH	Set AM Depth
:INC	Set AM step size
	Data type : Decimal Numeric Program Data
	Allowed suffices : PCT
	Default suffix : PCT
:<src>	Select modulation source where <src> is any one of: INT, EXTAC, EXTALC, or EXTDC
:ON	Turn AM ON (locally)
:OFF	Turn AM OFF (locally)
:UP	Go UP one step
:DN	Go DOWN one step
:RETN	Return to original setting
:XFER	Transfer current value to be the new setting
	Data type : None
	Allowed suffices : None
	Default suffix : None
	Examples: AM : DEPTH 30 . 5 PCT ; EXTAC ; ON AM1 : DEPTH 40 PCT ; INT ; OFF
:MODF	Set AM modulation oscillator frequency (short form)
:VALUE	Set AM modulation oscillator frequency
:INC	Set AM modulation oscillator frequency step size
	Data type : Decimal Numeric Program Data
	Allowed suffices : Any one of: GHZ, MHZ, KHZ or HZ
	Default suffix : HZ
:UP	Go UP one step
:DN	Go DOWN one step
:RETN	Return to original setting
:XFER	Transfer current value to be the new setting
:SIN	Select sinusoidal waveform
:TRI	Select triangle waveform
:SQR	Select square waveform
	Data type : None
	Allowed suffices : None
	Default suffix : None
:PHASE	Set phase offset of modulation oscillator relative to current phase
	Examples: AM2 : MODF : VALUE 15 . 5 KHZ ; TRI ; INC 500HZ AM : MODF : PHASE 5DEG

AM? or AM1? or AM2?

Prepares message containing information on Amplitude Modulation setting in one of the following formats:

```
:AM:DEPTH <nr2>;<src>;<status>;INC <nr2>  
:AM1:DEPTH <nr2>;<src>;<status>;INC <nr2>  
:AM2:DEPTH <nr2>;<src>;<status>;INC <nr2>
```

where <src> is a program mnemonic representing the source of the modulation signal and <status> is a program mnemonic indicating whether the amplitude modulation is locally ON or OFF

Example: :AM1:DEPTH 56.6;INT;ON;INC 5.0

AM:MODF? or AM1:MODF? or AM2:MODF?

Prepares message containing information on AM modulation oscillator setting in one of the following formats:

```
:AM:MODF:VALUE <nr2>;<shape>;INC <nr2>  
:AM1:MODF:VALUE <nr2>;<shape>;INC <nr2>  
:AM2:MODF:VALUE <nr2>;<shape>;INC <nr2>
```

where: <shape> is a program mnemonic representing the waveform shape

Example: :AM:MODF:VALUE 5000.00;TRI;INC 1000.00

Pulse modulation (source-specific)

PULSE

[not used alone]

:ON

Turn Pulse modulation ON

:OFF

Turn Pulse modulation OFF

Data type : None
Allowed suffices : None
Default suffix : None

Examples: PULSE : ON
PULSE : OFF

PULSE?

Prepares message containing information on Pulse Modulation setting in the following format:

:PULSE:<status>

where: <status> is a program mnemonic indicating whether the pulse modulation is ON or OFF

Examples: : PULSE : ON
: PULSE : OFF

Memory – store

STO

[not used alone]

:CFRQ Carrier Freq Store 0–99
:FULL Full Store 0–99
:RAM RAM Store 0–99

Data type : Decimal Numeric Program Data
Allowed suffices : None
Default suffix : None

Examples: STO:FULL 45
STO:CFRQ 16

Memory – recall

RCL

[not used alone]

:CFRQ Recall Carrier Freq Store 0–99
:FULL Recall Full Store 0–99
:RAM Recall RAM Store 0–99

Data type : Decimal Numeric Program Data
Allowed suffices : None
Default suffix : None

Examples: RCL:FULL 7
RCL:RAM 83

Memory – erase

ERASE

[not used alone]

:CFRQ Erase all Carrier Freq Stores (0–99)
:FULL Erase all Full Stores (0–99)
:RAM Erase all RAM Stores (0–99)
:ALL Erase all Stores (Carrier, Full and RAM stores)

Data type : None
Allowed suffices : None
Default suffix : None

Examples: ERASE:FULL
ERASE:ALL

Memory – protection

MPROT	[not used alone]
:CFRQ	[not used alone]
:START	Set the start of the Carrier Freq Stores memory block which is to be protected/unprotected.
:STOP	Set the end of the Carrier Freq Stores memory block which is to be protected/unprotected.
	Data type : Decimal Numeric Program Data
	Allowed suffices : None
	Default suffix : None
:ON	Set memory protection ON (that is, write-protected) for the selected Carrier Freq Stores memory block.
:OFF	Set memory protection OFF (that is, not write-protected) for the selected Carrier Freq Stores memory block.
	Data type : None
	Allowed suffices : None
	Default suffix : None
:FULL	[not used alone]
:START	Set the start of the Full Stores memory block which is to be protected/unprotected.
:STOP	Set the end of the Full Stores memory block which is to be protected/unprotected.
	Data type : Decimal Numeric Program Data
	Allowed suffices : None
	Default suffix : None
:ON	Set memory protection ON (that is, write-protected) for the selected Full Stores memory block.
:OFF	Set memory protection OFF (that is, not write-protected) for the selected Full Stores memory block.
	Data type : None
	Allowed suffices : None
	Default suffix : None
:RAM	[not used alone]
:START	Set the start of the RAM Stores memory block which is to be protected/unprotected.
:STOP	Set the end of the RAM Stores memory block which is to be protected/unprotected.
	Data type : Decimal Numeric Program Data
	Allowed suffices : None
	Default suffix : None
:ON	Set memory protection ON (that is, write-protected) for the selected RAM Stores memory block.
:OFF	Set memory protection OFF (that is, not write-protected) for the selected RAM Stores memory block.
	Data type : None
	Allowed suffices : None
	Default suffix : None

Examples: MPROT:CFRQ:START 50;STOP 99;ON
MPROT:FULL:OFF

Sweep operation

SWEEP	[not used alone]
:CFRQ	Optional command (may be omitted)
:START	Set Start Frequency
:STOP	Set Stop Frequency
:INC	Set Carrier Frequency sweep step size
	Data type : Decimal Numeric Program Data
	Allowed suffices : Any one of: GHZ, MHZ, KHZ or HZ
	Default suffix : HZ
:TIME	Select time per sweep step
	Data type : Decimal Numeric Program Data
	Allowed suffices : MS, S
	Default suffix : MS
	Example: SWEEP:CFRQ:START 100KHZ;STOP 500KHZ;INC 100HZ;TIME 60MS
SWEEP:CFRQ?	Prepares message containing information on Carrier Frequency Sweep settings in the following format: :SWEEP:CFRQ:START <nr2>;STOP <nr2>;INC <nr2>;TIME <nr2>
	Example: :SWEEP:CFRQ:START 1230000.0;STOP 1330000.0;INC 100.0;TIME 20.0

Sweep mode

Note that for triggering the order of priority is as follows:

- FSK logic input
- Memory recall
- Sweep trigger

Therefore ensure that FSK is not enabled, otherwise selecting sweep triggering will have no effect.

SWEEP	[not used alone]
:SOURCE	Select swept source (source A, B or C or sweep DISABLED)
	Data type : Character Program Data (either A, B, C or DISABLED)
	Allowed suffices : None
	Default suffix : None
	Example: SWEEP:SOURCE B
:MODE	Select Mode of operation for Sweep generator (single or continuous)
	Data type : Character Program Data (either SNGL or CONT)
	Allowed suffices : None
	Default suffix : None
	Example: SWEEP:MODE SNGL
:TRIG	Select trigger mode
	Data type : Character Program Data (any one of OFF, START, STARTSTOP, STEP)
	Allowed suffices : None
	Default suffix : None
	Example: SWEEP:TRIG STARTSTOP

SWEEP? Prepares message containing information on Sweep Source, Mode and Trigger in the following format:
:SWEEP:SOURCE <source>;MODE <mode>;TRIG <trig>

where: <source> is character program data indicating the sweep source selection, <mode> is character program data indicating the sweep mode selected, and <trig> is character program data indicating the trigger type selected.

Example: :SWEEP:SOURCE A;MODE CONT;TRIG STEP

Sweep control

SWEEP	[not used alone]
:GO	Commence Sweep
:HALT	Pause Sweep
:CONT	Continue Sweep
:RESET	Reset sweep to Start Value
:RETN	Return to original setting
:XFER	Transfer current value as the new setting
:UP	Go UP one sweep step while paused
:DN	Go DOWN one sweep step while paused

Data type : None
Allowed suffices : None
Default suffix : None

Examples: SWEEP:GO
SWEEP:RESET

Miscellaneous commands (source-specific)

RPP		Reset reverse power protection trip (short form)
:RESET		Reset RPP trip for current source.
	Data type :	None
	Allowed suffices :	None
	Default suffix :	None
	Example:	RPP : RESET
RPP:TRIPPED?		Prepares message containing information on whether the RPP Circuitry of the current source is currently tripped in the following format: <nr1> (0 = not tripped, 1 = tripped)
	Example:	1
RPP:COUNT?		Prepares message containing information on the number of times the RPP Circuitry of the current source has tripped in the following format: <nr1>
	Example:	3
ATTEN		[not used alone]
:LOCK		Lock the Attenuators of the current source.
:UNLOCK		Unlock the Attenuators of the current source.
	Data type :	None
	Allowed suffices :	None
	Default suffix :	None
	Example:	ATTEN : LOCK
ATTEN?		Prepares message containing information on whether the Attenuators of the current source are locked or unlocked in the following format: :ATTEN:<status> where <status> is a program mnemonic indicating whether the attenuators are locked or unlocked
	Example:	:ATTEN : LOCK

Miscellaneous commands (not source-specific)

ERROR?	<p>Prepares message relating to the next error in the error queue in the following format:</p> <p><nr1>, <string></p> <p>Where <string> is a descriptive error message. The numeric value returned is that of the next error number, or 0 if the queue is empty, or 399 if the queue is full. Errors with numbers in the range 1000–1999 are specific to source A, and 2000–2999 to source B and 3000–3999 to source C. Error numbers between 0 and 999 are not source-specific.</p> <p>Example: 1100, "Carrier limit"</p>
GPIB	<p>Set the GPIB Address (between 0 and 30 inclusive)</p> <p>Data type : Decimal Numeric Program Data Allowed suffices : None Default suffix : None</p> <p>Example: GPIB 7</p>
IMPEDANCE	<p>Set 50 Ω or 75 Ω adapter mode for all sources.</p> <p>Data type : Character program data (Z50R or Z75R) Allowed suffices : None Default suffix : None</p> <p>Example: IMPEDANCE Z75R</p>
IMPEDANCE?	<p>Prepares message containing information on which adapter mode is selected in the following format:</p> <p>:IMPEDANCE <char></p> <p>Example: :IMPEDANCE Z75R</p>
FSTD	<p>Select internal or external frequency standard</p> <p>Data type : Character program data (any one of INT, EXT10DIR, EXT11IND, EXT10IND or INT10OUT) Allowed suffices : None Default suffix : None</p> <p>Examples: FSTD INT FSTD EXT10IND</p>
FSTD?	<p>Prepares message containing information on frequency standard selection in the format:</p> <p>:FSTD <char></p> <p>Example: :FSTD EXT10IND</p>
BLANK	<p>[not used alone]</p>
:ON	<p>Blank the following display parameters: Carrier Frequency, RF Level, Modulation Depth and Deviations, and Modulation Frequency</p>
:OFF	<p>Turn the blanking off.</p> <p>Data type : None Allowed suffices : None Default suffix : None</p> <p>Examples: BLANK: ON BLANK: OFF</p>

BLANK?	Prepares message containing information on the display blanking setting in the following format: :BLANK:<state> where: <state> is program mnemonic indicating whether the blanking is ON or OFF Example: BLANK : OFF
CONTRAST	Sets the LCD contrast, over a scale of 0 to 31. Data type : Decimal Numeric Program Data Allowed suffices : none Default suffix : none Example: CONTRAST 16
CONTRAST?	Prepares message containing information on LCD contrast setting in the following format: :CONTRAST <nr1> Example: : CONTRAST 23
BRIGHTNESS	Sets the LCD brightness to DIM, MEDIUM or BRIGHT. Data type : Character Program Data Allowed suffices : None Default suffix : None Example: BRIGHTNESS MEDIUM
BRIGHTNESS?	Prepares message containing information on LCD brightness setting in the following format: :BRIGHTNESS <brightness> where: <brightness> is character program data indicating the brightness level. Example: : BRIGHTNESS BRIGHT
ELAPSED :RESET	Reset elapsed operating hours to zero Data type : None Allowed suffices : None Default suffix : None Example: ELAPSED : RESET
ELAPSED?	Prepares message containing information on elapsed operating hours since last reset. Fractional part is in 15 minute intervals (0.25, 0.50, 0.75). Format is as follows: <nr2> Example: 454 . 50
OPER?	Prepares message containing information on total operating hours. Fractional part is in 15 minute intervals (0.25, 0.50, 0.75). Format is as follows: <nr2> Example: 1453 . 00
POWUP	[not used alone]

:MODE Select the power up mode. The instrument can power up in either the factory preset mode or from a full store.
 Data type : Character program data (FACTORY or MEMORY)
 Allowed suffices : None
 Default suffix : None

:FULL Set the FULL store memory location for a memory power up.
 Data type : Decimal Numeric Program Data
 Allowed suffices : None
 Default suffix : None

Example: POWUP:MODE MEMORY
 POWUP:FULL 54

POWUP?

Prepares message containing information on the instrument power up selection in the following format:

:POWUP:MODE <mode>;FULL <nr1>

where: <mode> is character program data indicating the power up mode.

Example: :POWUP:MODE MEMORY;FULL 27

Status byte

The Status Byte provides information about events and conditions within the instrument. It may be read by a conventional Serial Poll or its value obtained as a response to the *STB? query. Bits 0 to 5 and bit 7 are each single-bit Summary Messages which may be of two types (or not used at all).

- (i) Query Status – a '1' indicates that an associated Queue is non-empty and has data available to be read.
- (ii) Status Register Summary – reports the occurrence of an enabled event monitored by a Status Register Structure.

The Service Request Enable Register determines which of the bits can generate an SRQ; this register may be set by *SRE or read by *SRE?. If the bitwise -AND of the Status Byte and the Enable Register is non-zero the Flag Master Summary Status (<mss>) is True. Bit 6 of the Status byte value read by *STB? holds <mss>. However bit 6 of the Status Byte when serial polled is the Request For Service bit used to determine which device on the Bus has asserted SRQ, and is cleared by a Serial Poll.

The IEEE 488.2 Standard defines bit 4 as Message Available (<mav>), the Queue Summary for the Output Buffer, indicating whether any part of a Response Messages is available to be read. Bit 5 is the Event Summary Bit (<esb>), the Summary Message from the Standard Event Status Register.

In 2026, bit 7 is a Queue Summary for the Error Queue. Bits 1, 2, and 3 are Status summaries for the Instrument Status, Coupling Status and Hardware Status Registers. Bit 0 is unused.

The following is an explanation of how the Hardware Event Registers operate. Note that the Coupling and Instrument Event Registers operate in a similar fashion, albeit the Instrument Transition Filter uses negative-going transitions.

Each source (A, B and C) has its own Hardware Condition Register, Transition Filter, Hardware Status Register and Hardware Status Enable Register.

For a particular source, the status of the hardware is continuously monitored by the Hardware Condition Register. The Transition Filter determines which transition of the Hardware Condition Register data bits will set the corresponding bit in the Hardware Status Register. In the case of the Hardware Registers, a positive-going transition will set the bits.

The bits in the Hardware Status Register are latched. Once set they remain set, regardless of subsequent changes in the associated condition bit until the Hardware Status Register is cleared by being read (SOURCE B HSR?) or by the *CLS common command. Once cleared, a Hardware Status Register bit will only be set again if a positive-going change in the Hardware Condition bit occurs.

The Hardware Status Enable Register may be written to and read from. This register is bitwise-ANDed with the Hardware Status Register and if the result is non-zero the Summary Message is true, otherwise the Summary Message is false. The Hardware Status Enable Register is not affected by *CLS but is however clear at power-on.

The Summary Messages of each source are logically ORed, resulting in a combined Summary Message. This combined Summary Message is reported in the Status Byte.

Status data structure – register model

Below is a generalized model of the Register Set which funnels the monitored data into a single summary bit to set the appropriate bit in the Status Byte.

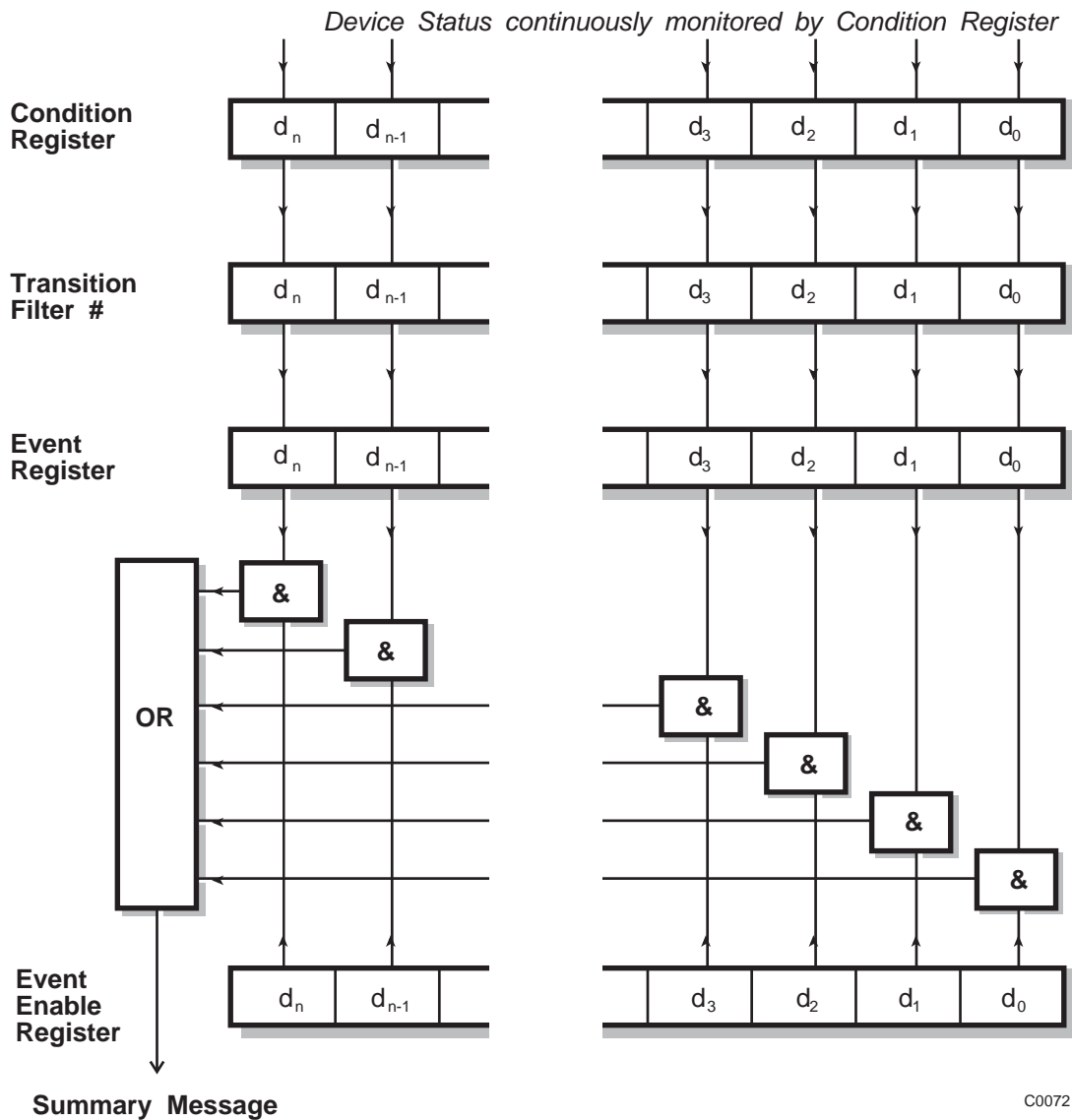

Note

The Device Status is continuously monitored by the Condition Register. If a Query to read a Condition Register is provided, the response represents the Status of the instrument at the moment the response is generated. A Condition Register cannot be written to.

The Transition Filter determines which transition of the Condition Register data bits will set the corresponding bit in the Event Register. Either positive-going, negative-going or both transitions can set bits in an Event Register. But in the 2026 the Transition Filters are pre-set as either Positive or Negative, as described in the following pages.

The bits in an Event Register are "latched". Once set they remain set, regardless of subsequent changes in the associated condition bit until the Event Register is cleared by being read or by the *CLS common command. Once cleared, an Event Register bit will only be set again if the appropriate change in the Condition bit occurs.

The Event Enable Register may be both written to and read from. It is bitwise AND-ed with the Event Register and if the result is non-zero the Summary Message is true, otherwise the Summary Message is false. Enable Registers are not affected by *CLS but are however clear at power-on.

Standard event registers

This Register is defined by IEEE 488.2 and each bit has the meaning shown below:

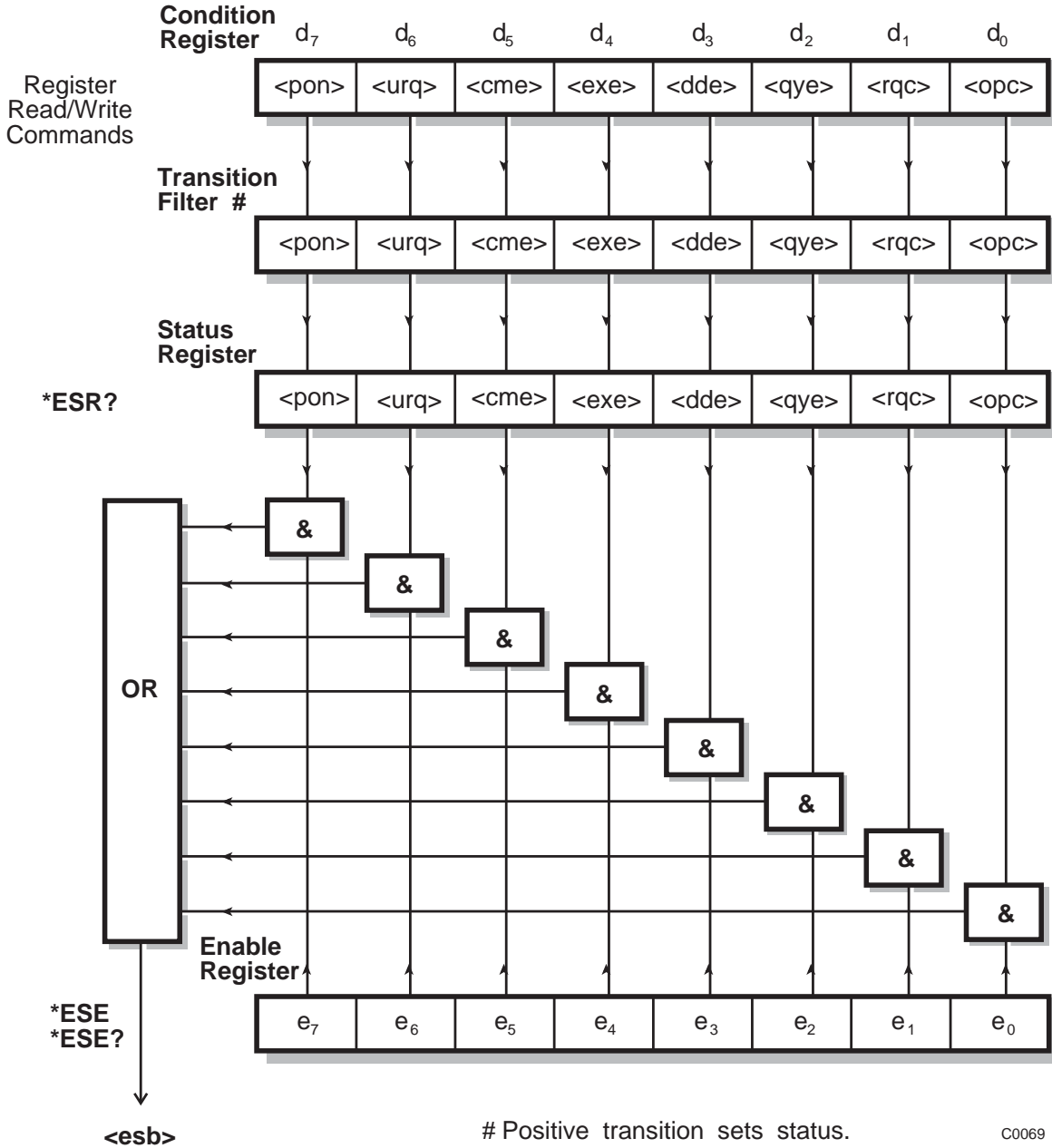

- <pon> power on
- <urq> user request – used by screen edit facility
- <cme> command error
- <exe> execution error
- <dde> device-dependent error
- <qye> query error
- <rqc> request control – not implemented in this product
- <opc> operation complete – set in response to the *OPC command for synchronization.

- <esb> standard event register summary bit

Hardware event registers

These are device-dependent registers and the bits have meanings as shown in the list at the bottom of the page. Each source (A, B and C) has its own set of registers, from which its respective hardware event register summary bits are jointly summarized in the Status Byte.

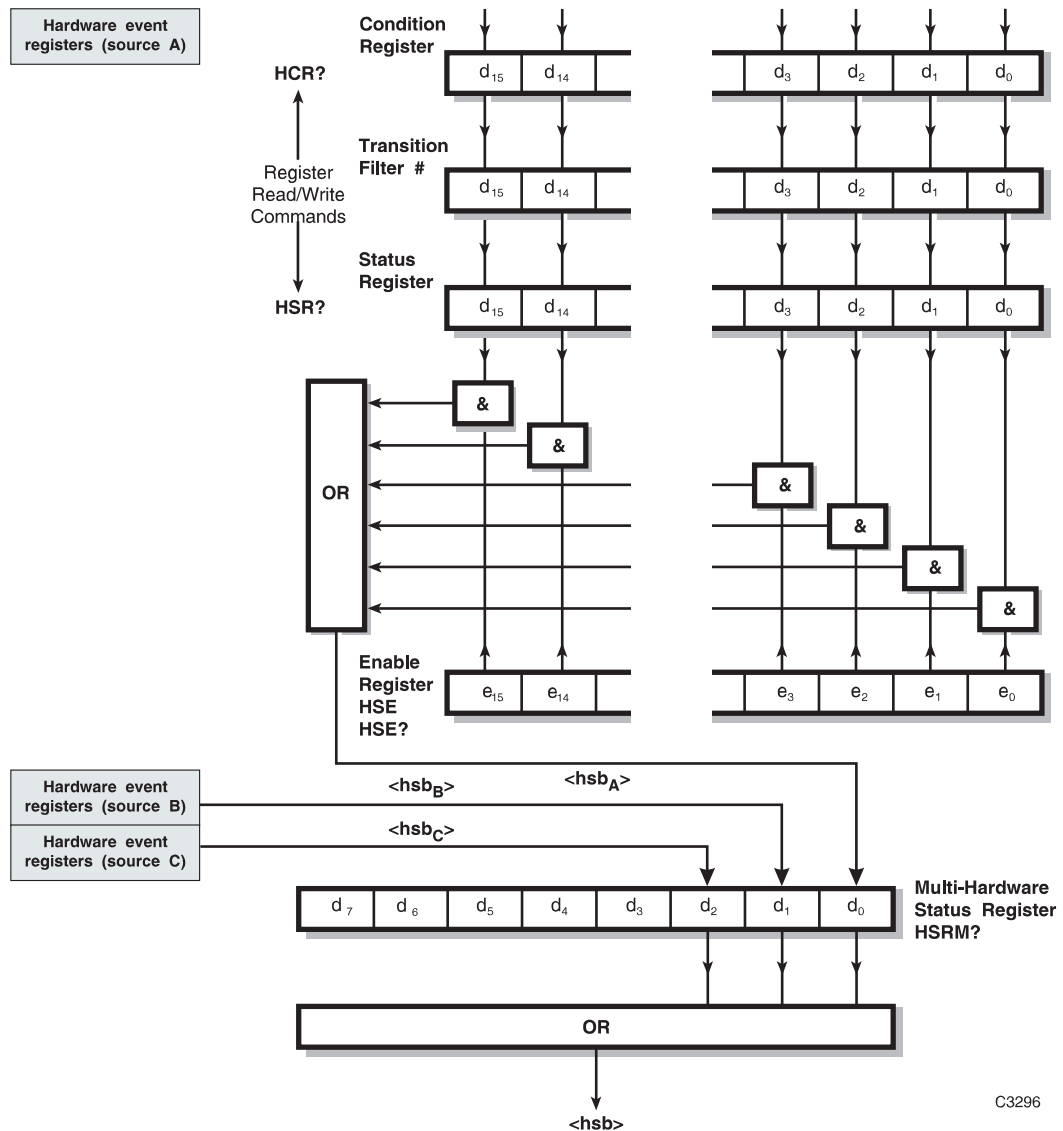

C3296

Positive transition sets status

d0	reverse-power protection tripped	d8	filter unlevelled
d1	fractional-n loop low	d9	output unlevelled
d2	fractional-n loop high	d10	high power amplifier failed
d3	external standard missing	d11	alc too high
d4	external standard frequency too low	d12	alc too low
d5	external standard frequency too high	d13	dsp not responding
d6	vx0 loop low	d14	rf level uncalibrated
d7	vx0 loop high	d15	not used

<hsb_A>, <hsb_B>, <hsb_C> hardware event register summary bits for each source (A, B and C)

<hsb> hardware event register summary bit (summarizes all sources).

To return status of d₃, d₄, d₅ when source selected is B or C, source A hardware status enable register HSE<nrf> must be set.

Coupling event registers

These are device-dependent registers and the bits have meanings as shown in the list at the bottom of the page. Each source (A, B and C) has its own set of registers, from which its respective coupling event register summary bits are jointly summarized in the Status Byte.

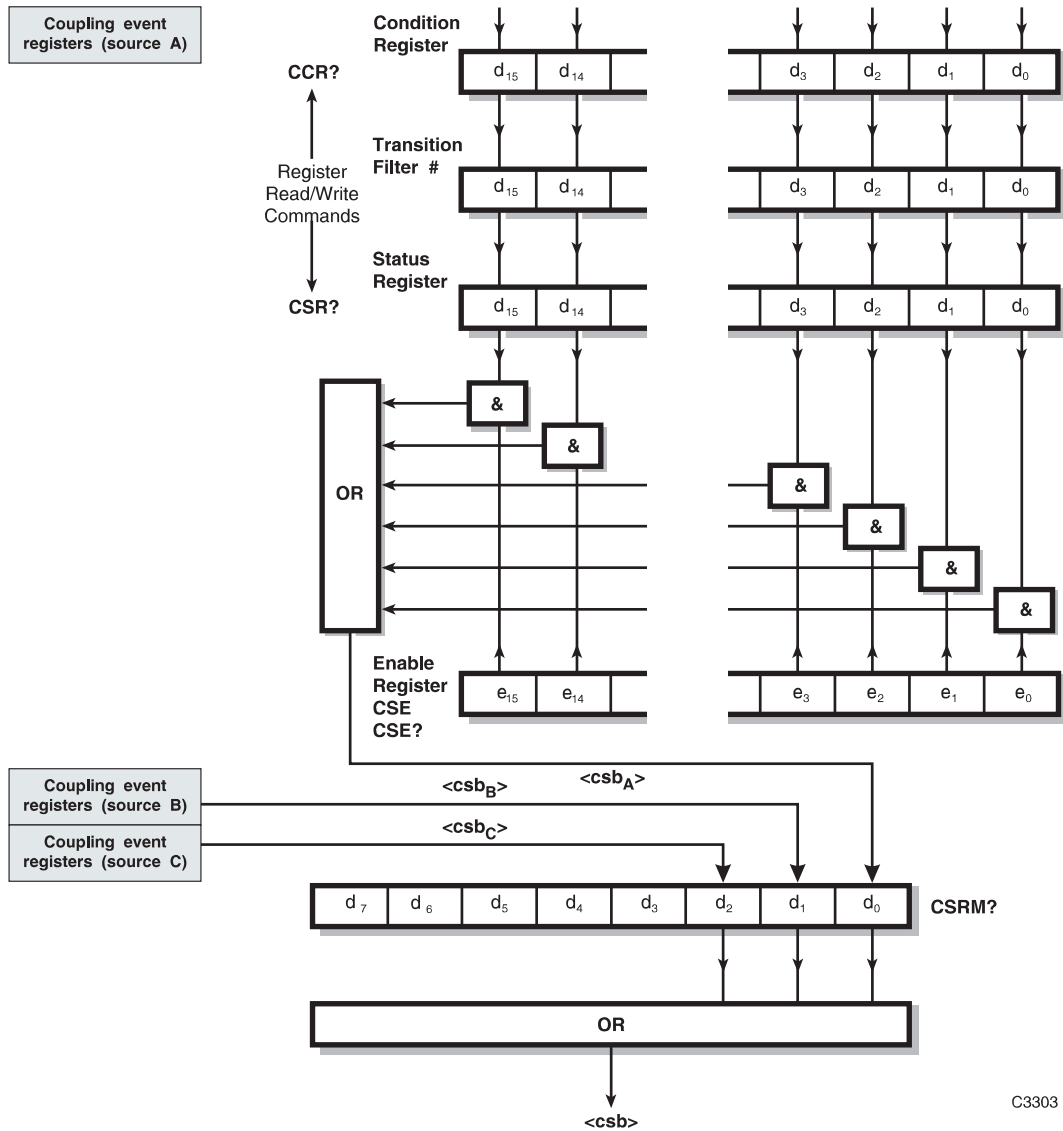

Positive transition sets status

- | | | | |
|----------------|--|-----------------|--------------------------------|
| d ₀ | rf level restricted by requested AM depth | d ₈ | not used |
| d ₁ | not used | d ₉ | not used |
| d ₂ | not used | d ₁₀ | carrier limited by coupling |
| d ₃ | am2 depth restricted by requested am1 depth | d ₁₁ | offset limited by harmonic |
| d ₄ | fm2 deviation restricted by requested fm1 deviation | d ₁₂ | offset limited by sub-harmonic |
| d ₅ | pm2 deviation restricted by requested pm1 deviation | d ₁₃ | harmonic limited by offset |
| d ₆ | number of sweep steps restricted by other parameters | d ₁₄ | sub-harmonic limited by offset |
| d ₇ | not used | d ₁₅ | not used |

<csb_A>, <csb_B>, <csb_C> coupling event register summary bits for each source (A, B and C)

<csb> coupling event register summary bit (summarizes all sources).

Instrument event registers

These are device-dependent registers and the bits have meanings as shown in the list at the bottom of the page. Each source (A, B and C) has its own set of registers, from which its respective instrument event register summary bits are jointly summarized in the Status Byte.

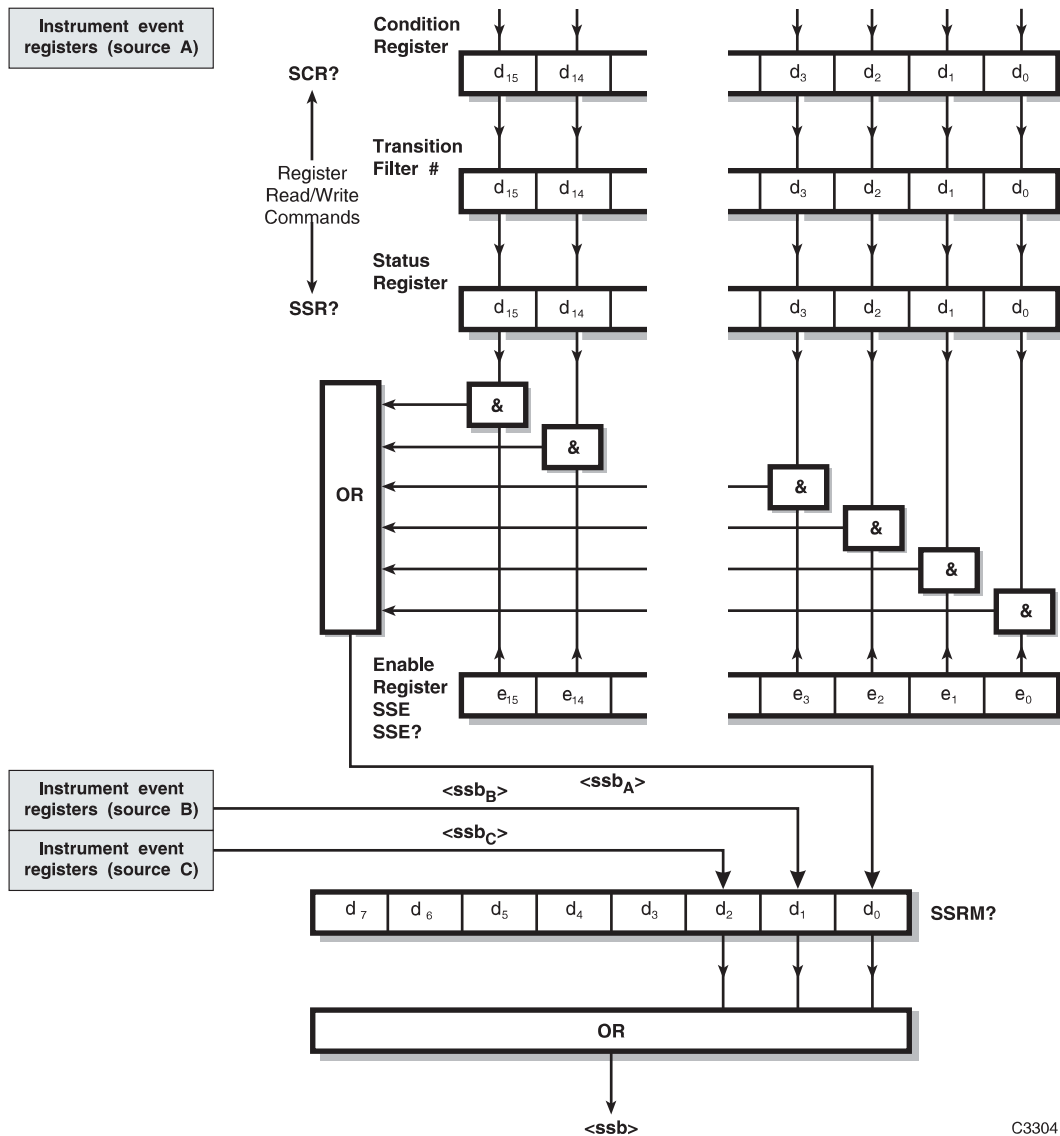

C3304

Negative transition sets status.

- | | | |
|---------------------------------|------------------------|----------------------|
| d ₀ | sweep in progress | end of sweep |
| d ₁ | not used | not used |
| d ₂ | selfcal in progress | selfcal completed |
| d ₃ | dc fm null in progress | dc fm null completed |
| d ₄ -d ₁₅ | not used | not used |

<ssb_A>, <ssb_B>, <ssb_C> coupling event register summary bits for each source (A, B and C)

<ssb> coupling event register summary bit (summarizes all sources).

Queue flag details

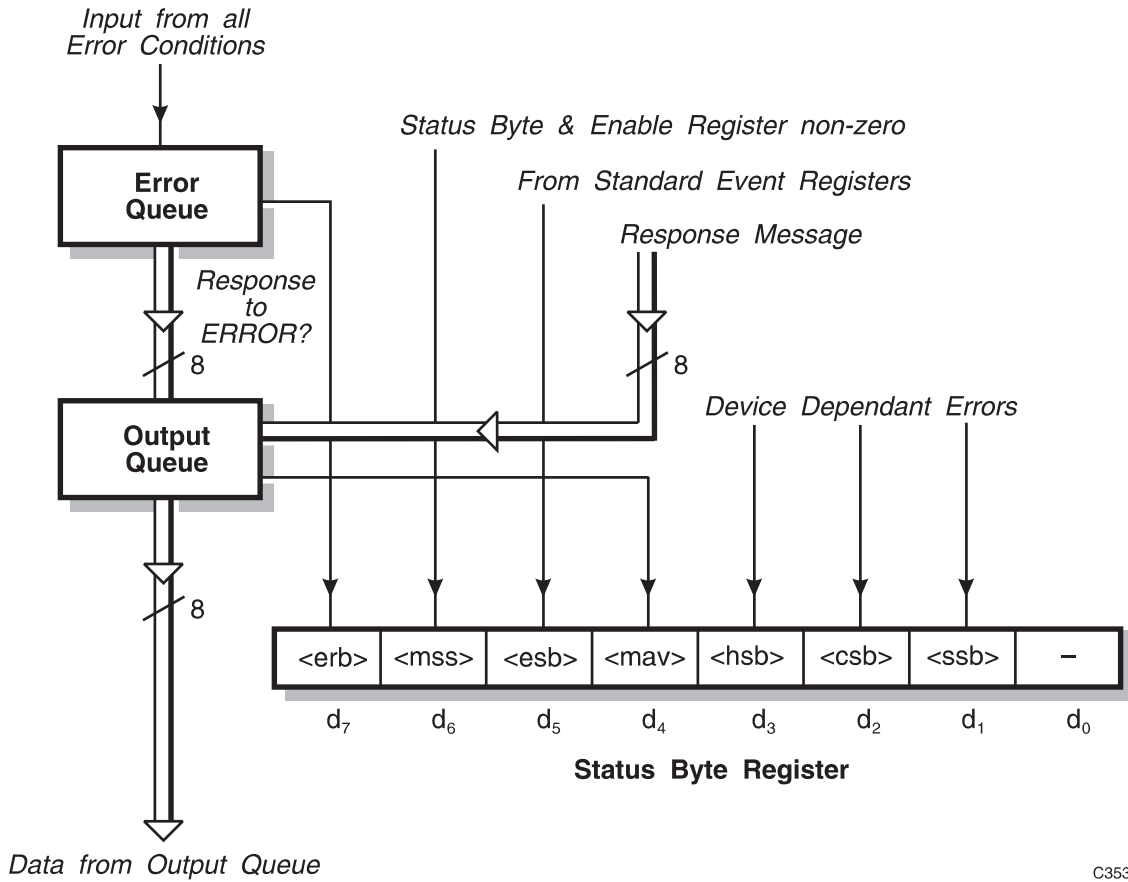

C3536

The <mav> status bit is set when one or more bytes are available to be read from the Output Queue.

The <erb> status bit is set when one or more errors are present in the Error Queue. The ERROR? query will place a nr1 response message in the Output Queue representing the Error at the head of the queue. If the queue is empty, this message will be 0.

Status byte when read by *stb?

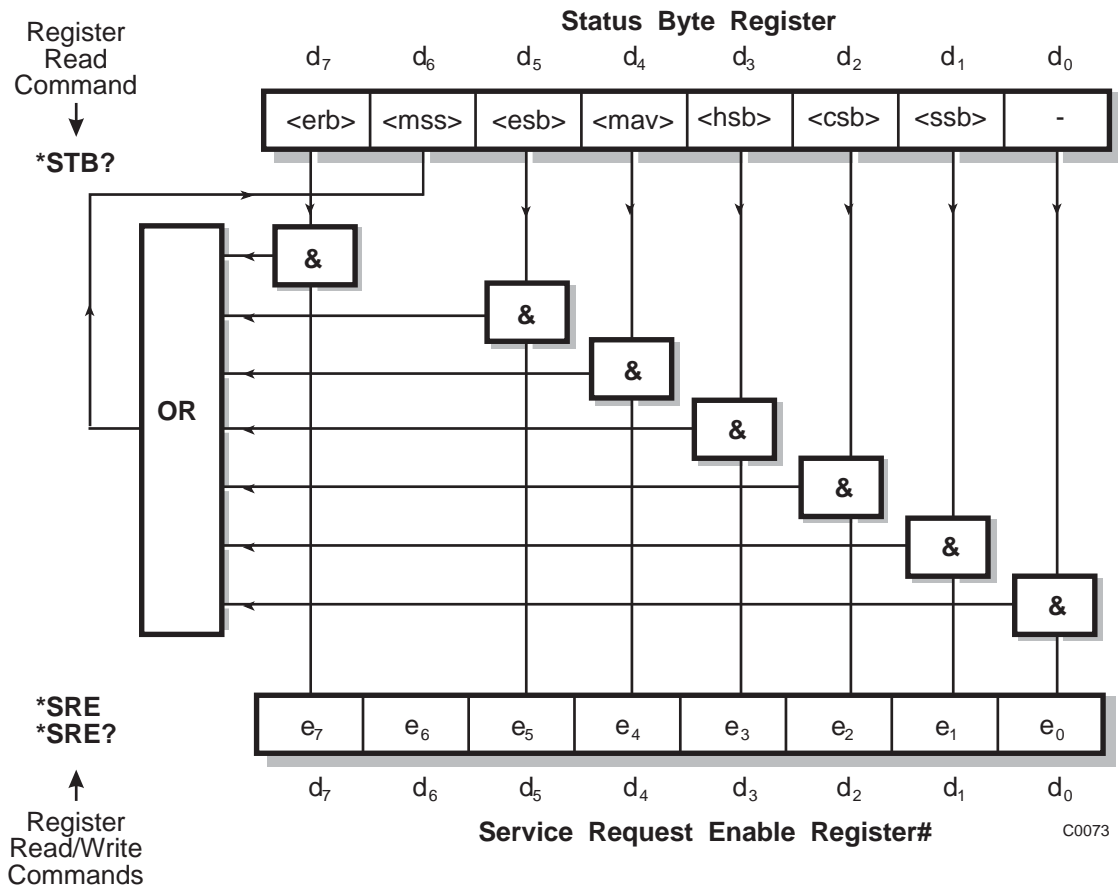

Bit 6 in this register ignores data sent by *SRE and always returns 0 in response to *SRE?

<rqs>, <esb> and <mav> are defined in IEEE 488.2

- <erb> is a device-defined queue summary bit indicating that the error queue is non-empty.
- <mss> is true when (Status Byte) AND (Enable register) > 0.
- <esb> is the standard event register summary bit.
- <mav> is 'message available' indicating that the output queue is non-empty.
- <hsb> is 'hardware status' summary bit
- <csb> is 'coupling status' summary bit
- <ssb> is 'instrument status' summary bit

Note

The Status Byte Register is not cleared by the *STB? query.

Status byte when read by serial poll

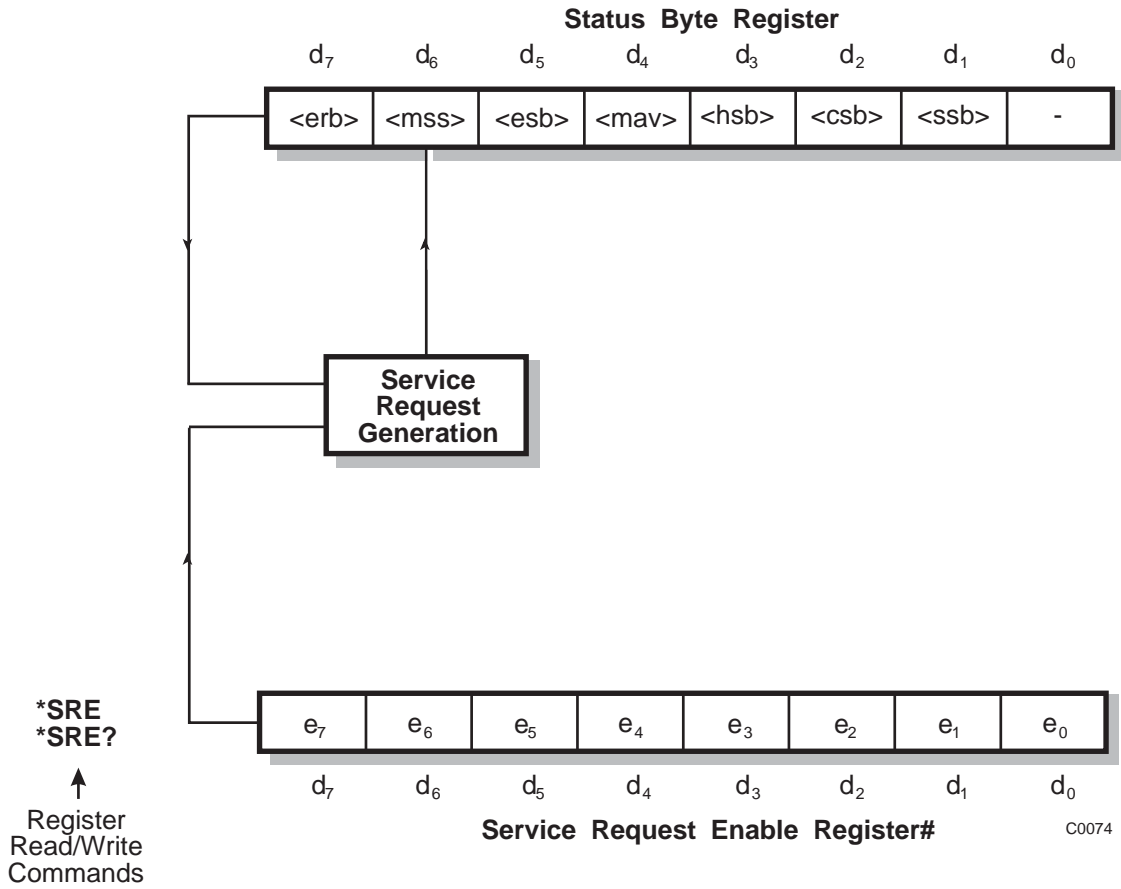

C0074

Bit 6 in this register ignores data sent by $*SRE$ and always returns 0 in response to $*SRE?$

- $\langle erb \rangle$ is a device-defined queue summary bit indicating that the error queue is non-empty.
- $\langle rqs \rangle$ is set by a request for service and is cleared by the poll.
- $\langle esb \rangle$ is the standard event register summary bit.
- $\langle mav \rangle$ is 'message available' indicating that the output queue is non-empty.
- $\langle hsb \rangle$ is 'hardware status' summary bit
- $\langle csb \rangle$ is 'coupling status' summary bit
- $\langle ssb \rangle$ is 'instrument status' summary bit

$\langle rqs \rangle$, $\langle esb \rangle$ and $\langle mav \rangle$ are defined in IEEE 488.2

$\langle rqs \rangle$ (request for service) will produce an SRQ at the controller. It is set by a change to either the Status Byte or the Service Enable Register that results in a New Reason for Service. It is cleared when $\langle mss \rangle$ goes FALSE (meaning, no reason for service) or by Serial Poll.

Summary of status reporting commands and queries

*CLS	Clears Status Registers and the Error Queue
*ESE<nrf>	Writes to Standard Event Enable Register
*ESE?	Reads from Standard Event Enable Register
*ESR?	Reads from Standard Event Status Register
*SRE<nrf>	Writes to Service Request Enable Register
*SRE?	Reads from Service Request Enable Register
*STB?	Reads from Status Byte Register
SOURCE A	Select source A as current
SOURCE B	Select source B as current
SOURCE C	Select source C as current
CCR?	Reads from Coupling Condition Register
CSE<nrf>	Writes to Coupling Status Enable Register
CSE?	Reads from Coupling Status Enable Register
CSR?	Reads from Coupling Status Register
HCR?	Reads from Hardware Condition Register
HSE<nrf>	Writes to Hardware Status Enable Register
HSE?	Reads from Hardware Status Enable Register
HSR?	Reads from Hardware Status Register
SCR?	Reads from Instrument Condition Register
SSE<nrf>	Writes to Instrument State Enable Register
SSE?	Reads from Instrument State Enable Register
SSR?	Reads from Instrument State Status Register
<nrf>	Decimal Numeric Program Data

All of the above queries respond with a nr1 numeric format.

Chapter 6

BRIEF TECHNICAL DESCRIPTION

Introduction

The 2026 is a multiple source generator which consists of two (or optionally, three) signal sources in one instrument. Each source is a fully functional RF signal generator with AM, FM, Φ M and pulse modulation capability. The 2026 covers the frequency range of 10 kHz to 2.4 GHz. Output levels range from -137 dBm to $+24$ dBm. A block schematic for the instrument is shown in Fig. 6-1.

The block diagram shows the internal circuits of one of the sources, the C source, in detail. The A and B sources have the same configuration. Data from the AUXILIARY PORT and the instrument frequency standard are fed to all sources. RF output from each source is switched either directly to its individual RF OUTPUT socket or to the combiner then out to the COMBINED RF OUTPUT connector. In the case of an instrument fitted with a third source, the C source output to the combiner is via an external link connected between the INT O/P and the EXT I/P sockets.

Modulation

The carrier frequency of each signal source can be frequency, phase or amplitude modulated from internal or external modulation sources. The internal modulation source can be the sum of two signals and used in combination with an external modulation source connected to the front-panel EXT MOD INPUT connector. In addition to analogue FM, 2-level and 4-level FSK signals are generated from external logic inputs to the AUXILIARY PORT connector.

Frequency generation

A voltage controlled oscillator (VCO) in each signal source covering the frequency range 400 to 533 MHz is phase locked to a 10 MHz temperature-compensated crystal oscillator using a fractional-N synthesizer system. Additional frequency coverage is achieved by means of frequency division or multiplication. Low frequencies are generated by a beat frequency oscillator (BFO) system.

Display

The display is a high-definition dot-matrix liquid crystal panel with backlighting to cater for variations in ambient light conditions. The display contrast can be adjusted.

Control

The 2026 is a menu-driven instrument. Main menus are displayed by the use of hard keys, and parameters are changed by means of soft keys which change as the menu changes. Internal control of the instrument is achieved by a microprocessor which receives data from the various controls and sends instructions via an internal 8-bit data bus to the signal processing circuits.

The instrument can also be controlled by either the built-in General Purpose Interface Bus (GPIB) or the RS-232 interface. The interfaces enable the instrument to be used both as a manually-operated bench-mounted instrument and as part of a fully automated test system. The RS-232 interface can also be used to reprogram the internal flash memory.

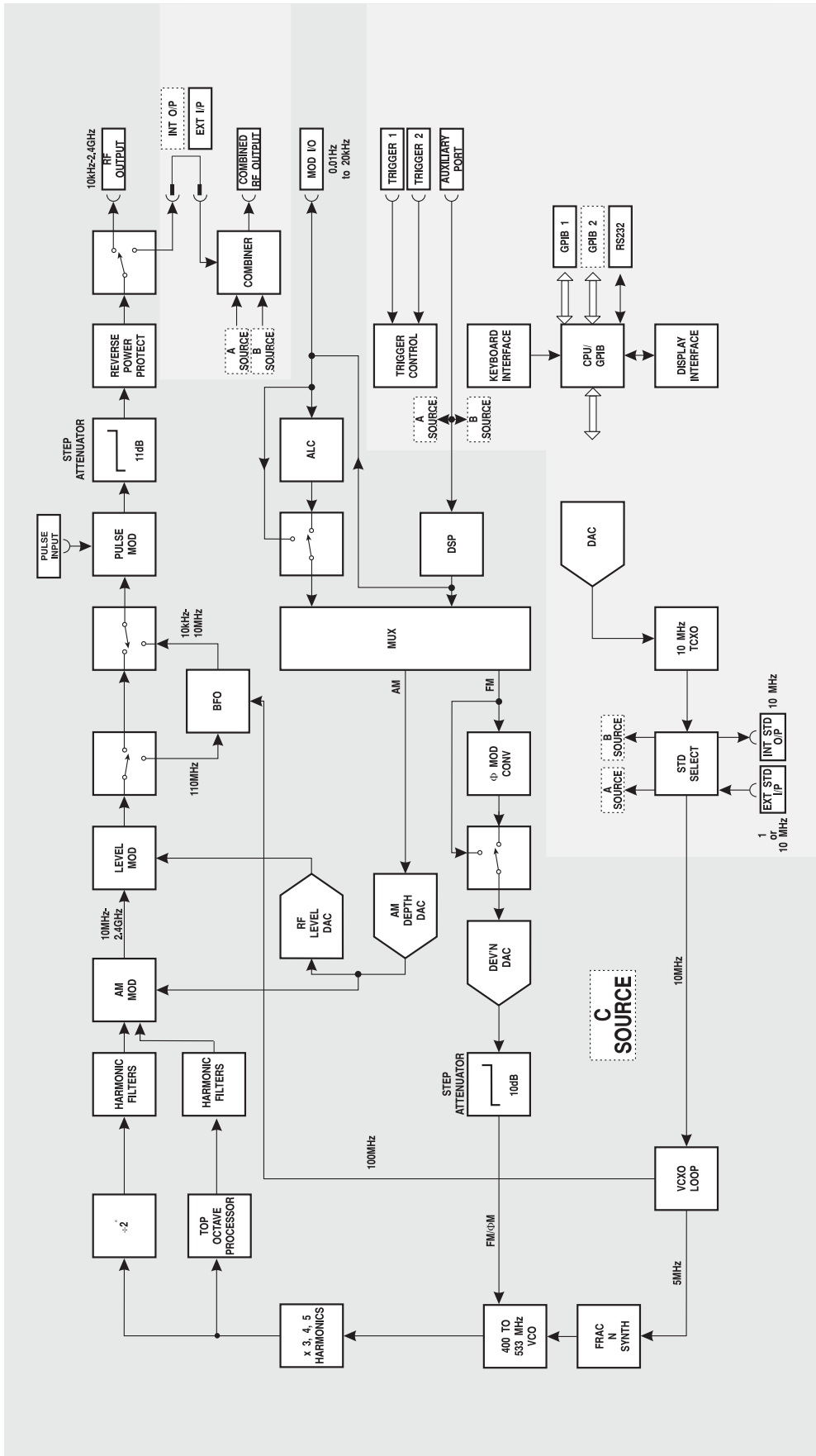

C3954

Fig. 6-1 Block diagram of 2026 (with the C source shown in detail)

Chapter 7

ACCEPTANCE TESTING

Contents

Introduction.....	7-3
Test precautions	7-3
Recommended test equipment	7-4
Test procedures	7-5
RF output	7-5
Individual sources	7-5
Combined RF output.....	7-8
Carrier frequency accuracy	7-9
Spectral purity	7-10
Individual sources	7-10
Combined RF output.....	7-14
Internal FM	7-16
FM deviation and distortion.....	7-17
FM scale shape	7-17
Carrier error	7-17
External FM frequency response (ALC off, DC coupled).....	7-18
External FM frequency response (ALC on).....	7-19
Phase modulation	7-20
Phase modulation.....	7-20
Phase modulation flatness.....	7-20
Amplitude modulation	7-21
AM depth and distortion.....	7-21
AM scale shape.....	7-22
External AM frequency response (ALC off, DC coupled).....	7-22
Pulse modulation.....	7-24
Pulse modulation RF level frequency response	7-24
Pulse modulation on/off ratio	7-25
Pulse modulation rise and fall time.....	7-26
Modulation oscillator	7-26
Modulation oscillator frequencies.....	7-27
Modulation oscillator distortion and LF output flatness	7-28
External frequency standard input	7-28
Acceptance test results tables.....	7-31

List of tables

Table 7-1 RF output at 0 dBm	7-31
Table 7-2 RF output at +6 dBm	7-32
Table 7-3 RF output at +13 dBm	7-33
Table 7-4 RF output at +24 dBm	7-34
Table 7-5 ALC linearity at 2.5 MHz.....	7-35
Table 7-6 ALC linearity at 500 MHz.....	7-36
Table 7-7 ALC linearity at 2400 MHz.....	7-37
Table 7-8 Attenuator test at 2.6 MHz	7-38
Table 7-9 Attenuator test at 540.1 MHz	7-38
Table 7-10 Attenuator test at 1140.1 MHz	7-39
Table 7-11 Attenuator test at 1740.1 MHz	7-39
Table 7-12 Attenuator test at 2399 MHz	7-40
Table 7-13 Alternative attenuator functional test at 10 MHz.....	7-40
Table 7-14 Combined RF output at -18 dBm.....	7-41
Table 7-15 Combined RF output at -13 dBm.....	7-42

Table 7-16	Combined RF output at +4 dBm.....	7-43
Table 7-17	Carrier frequency tests.....	7-44
Table 7-18	Carrier harmonic tests at -4 dBm.....	7-45
Table 7-19	Carrier harmonic tests at 0 dBm.....	7-46
Table 7-20	Carrier harmonic tests at +7 dBm.....	7-47
Table 7-21	Carrier harmonic tests at +18 dBm.....	7-48
Table 7-22	Carrier non-harmonic tests.....	7-49
Table 7-23	Residual FM test.....	7-49
Table 7-24	SSB phase noise test.....	7-49
Table 7-25	RF leakage test.....	7-50
Table 7-26	Sources A/B intermod test.....	7-50
Table 7-27	Sources A/C intermod test (Option 1 only).....	7-51
Table 7-28	Sources B/C intermod test (Option 1 only).....	7-51
Table 7-29	Isolation tests.....	7-52
Table 7-30	Internal FM deviation and distortion tests at 100 kHz deviation.....	7-52
Table 7-31	FM scale shape tests at 15 MHz carrier.....	7-53
Table 7-32	Carrier error test at 1.2 GHz, FM deviation 100 kHz.....	7-53
Table 7-33	External FM frequency response (ALC off, DC coupled), 50 kHz deviation.....	7-53
Table 7-34	External FM frequency response (ALC on), 10 kHz deviation, 0.75 V input.....	7-54
Table 7-35	External FM frequency response (ALC on), 10 kHz deviation, 1.25 V input.....	7-54
Table 7-36	Internal FM and distortion test at 10.5 MHz carrier, 10 rad deviation.....	7-54
Table 7-37	Internal FM flatness test.....	7-55
Table 7-38	Internal AM depth and distortion tests at -4 dBm.....	7-55
Table 7-39	Internal AM depth and distortion tests at 0 dBm.....	7-56
Table 7-40	Internal AM depth and distortion tests at +6 dBm.....	7-57
Table 7-41	Internal AM depth and distortion tests at +10 dBm.....	7-58
Table 7-42	AM scale shape test.....	7-58
Table 7-43	External AM frequency response (ALC off, DC coupled), RF level -4 dBm.....	7-59
Table 7-44	External AM frequency response (ALC off, DC coupled), RF level +6 dBm.....	7-59
Table 7-45	Pulse mod. RF output at -7 dBm.....	7-60
Table 7-46	Pulse mod. RF output at +4 dBm.....	7-61
Table 7-47	Pulse modulation on/off ratio test.....	7-61
Table 7-48	Pulse modulation rise and fall time test.....	7-62
Table 7-49	Modulation oscillator frequency tests.....	7-62
Table 7-50	Modulation oscillator distortion and LF output tests.....	7-62
Table 7-51	External frequency standard tests.....	7-62

List of figures

Fig. 7-1	RF output test set-up.....	7-6
Fig. 7-2	Attenuator accuracy test set-up.....	7-7
Fig. 7-3	Carrier frequency accuracy test set-up.....	7-9
Fig. 7-4	Carrier harmonics and non-harmonics test set-up.....	7-11
Fig. 7-5	Residual FM test set-up.....	7-12
Fig. 7-6	SSB phase noise test set-up.....	7-12
Fig. 7-7	RF leakage test set-up.....	7-13
Fig. 7-8	Combined output intermodulation test set-up.....	7-14
Fig. 7-9	Internal modulation and modulation distortion test set-up.....	7-17
Fig. 7-10	External modulation and modulation distortion test set-up.....	7-18
Fig. 7-11	External AM and distortion test set-up.....	7-23
Fig. 7-12	Pulse modulation test set-up.....	7-24
Fig. 7-13	Pulse modulation on/off ratio test set-up.....	7-25
Fig. 7-14	Pulse modulation rise and fall time test set-up.....	7-26
Fig. 7-15	Modulation oscillator frequency test set-up.....	7-27
Fig. 7-16	Modulation oscillator distortion test set-up.....	7-28
Fig. 7-17	External standard test set-up.....	7-29

Introduction

The test procedures in this chapter enable you to verify that the electrical performance of the signal generator complies with the specifications given in Chapter 1. For convenience, the test equipment and specification for each test are summarized before the test procedure.

Apart from the UUT, (Unit Under Test), no specific set-up procedures will be included for the test equipment unless the measurement is dependent on specific instrument settings or special measurement techniques.

Test precautions

To ensure minimum errors and uncertainties when making measurements, it is important to observe the following precautions:

- (1) Always use recently-calibrated test equipment, with any correction figures taken into account, so as to establish a known traceable limit of performance uncertainty. This uncertainty must be allowed for in determining the accuracy of measurements.
- (2) A common external frequency standard, with an accuracy of ± 1 part in 10^9 should be used for any frequency-controlled test equipment.
- (3) Use the shortest possible connecting leads.
- (4) Some areas of the specification which are labeled 'typical' rather than having clearly defined limits are *not* tested.

Recommended test equipment

The test equipment recommended for acceptance testing is shown below. Alternative equipment may be used provided it complies with the stated minimum specification.

Recommended test equipment

Description	Minimum specification	Example
Power meter	± 0.1 dB from 10 kHz to 2.4 GHz	IFR [†] 6960B with 6912 and 6932 Sensors
Measuring receiver	0 dBm to -127 dBm; 2.5 MHz to 2.4 GHz. Capable of measuring residual FM < 2 Hz and SSB phase noise < -124 dBc/Hz at 20 kHz offset from a 1 GHz carrier	Agilent 8902A with Option 037* and 11722A Sensor and 11793A Down-Converter [#]
Signal generator	+8 dBm from 32.5 MHz to 2.43 GHz	IFR [†] 2041
Frequency counter	10 Hz to 2.4 GHz	EIP 535B or IFR [†] 2440
Audio analyzer	Capable of measuring THD of 0.01% from 100 Hz to 20 kHz	Rohde & Schwarz UPA3
Spectrum analyzer	DC to 7.2 GHz, 3 Hz resolution bandwidth	Anritsu MS2602A or IFR [†] 2386
Modulation meter	AM, FM and Φ M 50 kHz to 2.4 GHz. Accuracy $\pm 1\%$ at 1 kHz modulation frequency	IFR [†] 2305 plus Distortion Option **
Function generator	DC to 100 kHz sine, ± 0.6 dB flatness, 100 kHz square wave	Agilent 3325B
Digital voltmeter	DC voltage measurement	Solartron 7150+
50 Ω load (termination)	1 W, 50 Ω nominal impedance, DC to 2.4 GHz	Lucas Weinschel M1404N
2-turn loop	25 mm diameter	
Oscilloscope	100 MHz bandwidth	Tektronix TAS 465

[†]IFR Ltd. was previously known as Marconi Instruments Ltd.

* Option 037 is necessary to measure SSB phase noise.

[#] If the receiver and down-converter are not available, an alternative procedure to ensure attenuator pad accuracy using a power meter is given.

** The distortion option of the 2305 Modulation Meter allows modulation distortion tests to be carried out with greater ease. If a 2305 with the distortion option is not available, the audio analyzer may be connected to the modulation meter LF output and set to measure distortion.

Test procedures

Before each test procedure, set the UUT to its power-up conditions. To avoid switching the instrument off and back on, reset the UUT by selecting:

[MEM] [Factory Recall]

At the end of this chapter are a set of results tables which give all the test points for each of the tests. These tables should be photocopied and used to record the results of all the measurements taken.

Tests for the options, where necessary, are included with the tests for the standard instrument.

RF output

Individual sources

Specification

Level range:	–137 dBm to +24 dBm for carrier frequencies up to 1.2 GHz, –137 dBm to +20 dBm for carrier frequencies above 1.2 GHz.
Accuracy:	For output levels from –127 dBm to +6 dBm and over a temperature range of 17°C to 27°C: ±0.8 dB to 1.2 GHz ±1.6 dB to 2.4 GHz For output levels above +6 dBm: ±1.0 dB 100 kHz to 1.2 GHz † ±2.0 dB to 2.4 GHz † Unspecified below 100 kHz. Temperature coefficient <±0.02 dB/°C to 1.2 GHz and <±0.04 dB/°C to 2.4 GHz.
Output impedance:	50 Ω
VSWR	<1.5:1 to 1.2 GHz <1.7:1 to 2.4 GHz (for output levels less than –5 dBm).

Test equipment

Description	Minimum specification	Example
Power meter	±0.1 dB from 10 kHz to 2.4 GHz	IFR 6960B 6912 and 6932
Measuring receiver	0 dBm to –127 dBm; 2.5 MHz to 2.4 GHz	Agilent 8902A with 11722A Sensor and 11793A Down-Converter
Signal generator	+8 dBm from 32.5 MHz to 2.43 GHz	IFR 2041

RF level frequency response

Test procedure

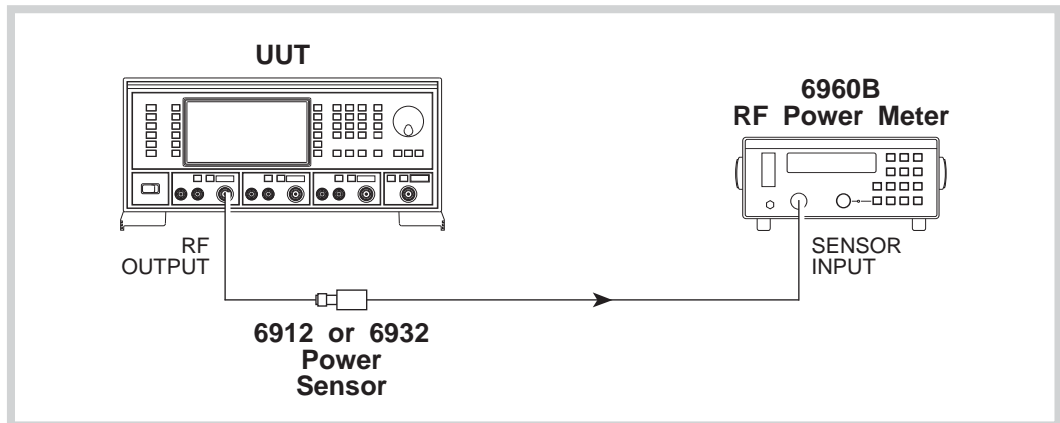

C3491

Fig. 7-1 RF output test set-up

- (1) Perform AUTO ZERO and AUTO CAL on the power meter.
- (2) Connect the test equipment as shown in Fig. 7-1.
- (3) On the UUT set source A to:

[Carrier Freq]	30 [kHz]
[RF Level]	0 [dB]
- (4) Record the output level measured by the power meter against each of the carrier frequencies shown in Table 7-1 checking that the results are within specification.
- (5) Set the UUT RF level to +6 dBm and repeat (4) using Table 7-2.
- (6) Set the UUT RF level to +13 dBm and repeat (4) using Table 7-3.
- (7) Change the 6912 sensor for the 6932 sensor when measuring levels greater than +20 dBm. Set the UUT RF level to +24 dBm and repeat (4) using Table 7-4.
- (8) Repeat (1) to (7) for source B and, if Option 1 is fitted, source C.

ALC linearity

Test procedure

- (1) Perform AUTO ZERO and AUTO CAL on the power meter.
- (2) Connect the test equipment as shown in Fig. 7-1.
- (3) On the UUT set source A to:

[Carrier Freq]	2.5 [MHz]
[RF Level]	-4 [dB]
- (4) Record the output level measured by the power meter against each of the steps shown in Table 7-5 checking that the results are within specification. Change the 6912 sensor for the 6932 sensor when measuring levels greater than +20 dBm.
- (5) Set the UUT carrier frequency to 500 MHz and repeat (4) using Table 7-6.
- (6) Set the UUT carrier frequency to 2400 MHz and repeat (4) using Table 7-7.
- (7) Repeat (1) to (6) for source B and, if Option 1 is fitted, source C.

Attenuator accuracy

The following test will confirm that the attenuator performs to the published performance specification. In the event of the receiver/down-converter not being available, an alternative method to functionally test the individual pads is also suggested. (See 'Alternative attenuator functional test')

Test procedure

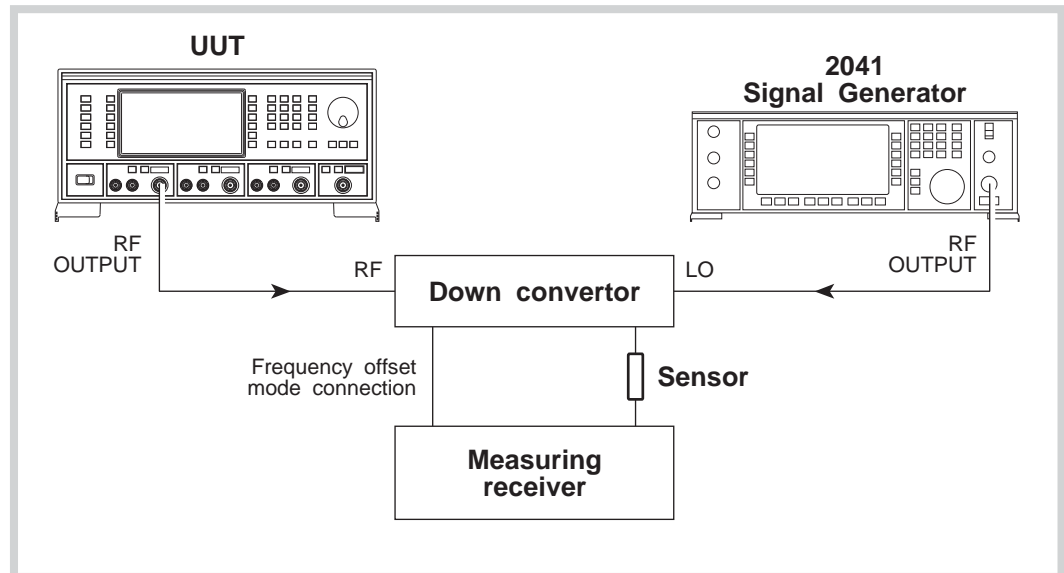

C3493

Fig. 7-2 Attenuator accuracy test set-up

- (1) Connect the test equipment as shown in Fig. 7-2.
- (2) On the UUT set source A to:

[Carrier Freq]	2.6 [MHz]
[RF Level]	0 [dB]
[Total Δ]	
[RF Level Shift]	11 [dB]
- (3) Tune the receiver to 2.6 MHz and record the output level measured in Table 7-8 checking that the result is within specification.
- (4) Set the UUT RF level to -4.1 dBm. Measure the received level and record the result in Table 7-8 checking that the result is within specification.
- (5) Decrement the UUT, using the [+10 ↓] key, in 11 dB steps down to an RF level of -114.1 dBm measuring the received level at each step shown in Table 7-8. Check that the results are within specification.
- (6) Set the UUT to carrier frequency 540.1 MHz and repeat (2) to (5) using Table 7-9.
- (7) Set the UUT to carrier frequency 1140.1 MHz and repeat (2) to (5) using Table 7-10.
- (8) Set the local oscillator to +8 dBm at a carrier frequency of 62 MHz less than the test frequency (that is, a frequency of 1678.1 MHz).
The down converter is automatically enabled when testing frequencies above 1300 MHz.
- (9) On the receiver, enter the local oscillator frequency followed by the test frequency.
- (10) Set the UUT to carrier frequency 1740.1 MHz and repeat (2) to (5) using Table 7-11.
- (11) Set the UUT to carrier frequency 2399 MHz and repeat (2) to (5) using Table 7-12.
- (12) Repeat (2) to (11) for source B and, if Option 1 is fitted, source C.

- (3) On the UUT set source A to:
 - [Carrier Freq] 1 [MHz]
 - [RF Level] -18 [dB]
 - [SET UP]
 - [Combiner Setup] [A O/P / Σ] [EXIT] [SIG GEN]
- (4) Record the output level measured by the power meter against each of the carrier frequencies shown in Table 7-14 checking that the results are within specification.
- (5) Set the UUT RF level to -13 dBm and repeat (4) using Table 7-15.
- (6) Set the UUT RF level to +4 dBm and repeat (4) using Table 7-16.
- (7) Repeat (1) to (6) for source B and, if Option 1 is fitted, source C, ensuring that only one source at a time is routed to the combiner.

Carrier frequency accuracy

This check provides a conventional method of checking the signal generator frequency locking circuitry. It will confirm correct operation of phase locked loops and dividers. Overall accuracy is determined by the instrument's internal reference standard.

Specification

Frequency range:	10 kHz to 2.4 GHz.
Accuracy:	Determined by the frequency standard accuracy.
Resolution:	1 Hz

Test equipment

Description	Minimum specification	Example
Frequency counter	10 kHz to 2.4 GHz	EIP 535B or IFR 2440
50 Ω load (termination)	1 W, 50 Ω nominal impedance, DC to 2.4 GHz	Lucas Weinschel M1404N

Test procedure

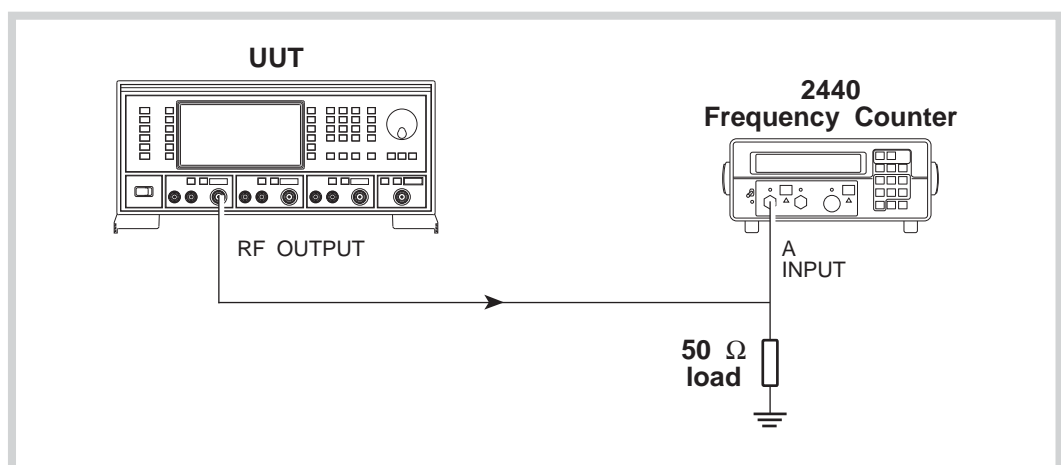

C3503

Fig. 7-3 Carrier frequency accuracy test set-up

- (1) Connect the test equipment as shown in Fig. 7-3.

- (2) Connect the internal frequency standard from the UUT to the external standard input on the counter.
- (3) On the UUT set source A to:

<i>[Carrier Freq]</i>	10 [kHz]
<i>[RF Level]</i>	0 [dB]
- (4) Record the frequency measured by the counter against each of the carrier frequencies shown in Table 7-17. (Since the two instruments' frequencies are locked together, the limit is ± 1 digit on the counter display.)
- (5) At 1200 MHz disconnect the UUT internal frequency standard from the counter and instead apply the external reference. Check the result against the limits.

Notes

If the instrument is fitted with Option 3, (high stability frequency standard), use the *second* 1200 MHz test limits.

The test limits quoted are for guidance and assume that the internal frequency standard has recently been adjusted. Aging and stability have to be considered when establishing the *real* test limits. (See specifications in Chapter 1.)

It will be necessary to disconnect the 50 Ω load and reconnect the UUT RF OUTPUT to the B input and C input where necessary.

- (6) Repeat (2) to (5) for source B and, if Option 1 is fitted, source C.

Spectral purity

Individual sources

Specification

Harmonics:	Typically better than -30 dBc for RF levels up to $+6$ dBm. Typically better than -25 dBc for RF levels up to $+18$ dBm ($+14$ dBm above 1.2 GHz).
Non harmonics: (for offsets >3 kHz)	Better than -70 dBc for carrier frequencies up to 1 GHz. Better than -64 dBc for carrier frequencies above 1 GHz. Better than -60 dBc for carrier frequencies above 2 GHz.
Residual FM:	Less than 4.5 Hz RMS in a 300 Hz to 3.4 kHz bandwidth at a carrier frequency of 1 GHz.
SSB phase noise:	Better than -124 dBc/Hz at 20 kHz offset from a 470 MHz carrier. Typically less than -121 dBc/Hz at 20 kHz offset from a 1 GHz carrier.
Carrier leakage:	Less than $0.5 \mu\text{V}$ at the carrier frequency into a two-turn 25 mm loop 25 mm away from the surface of the signal generator.

Test equipment

Description	Minimum specification	Example
Spectrum analyzer	DC to 7.2 GHz frequency coverage	Anritsu MS2602A or IFR 2386
Measuring receiver	0 dBm to -127 dBm; 2.5 MHz to 2.4 GHz. Capable of measuring residual FM <2 Hz and SSB phase noise <-124 dBc/Hz at 20 kHz offset from a 1 GHz carrier	Agilent 8902A with Option 037
Signal generator	$+8$ dBm from 32.5 MHz to 2.43 GHz	IFR 2041
50 Ω load	1 W, 50 Ω nominal impedance, DC to 2.4 GHz	Lucas Weinschel M1404N
2-turn loop	25 mm diameter	

Harmonics

Test procedure

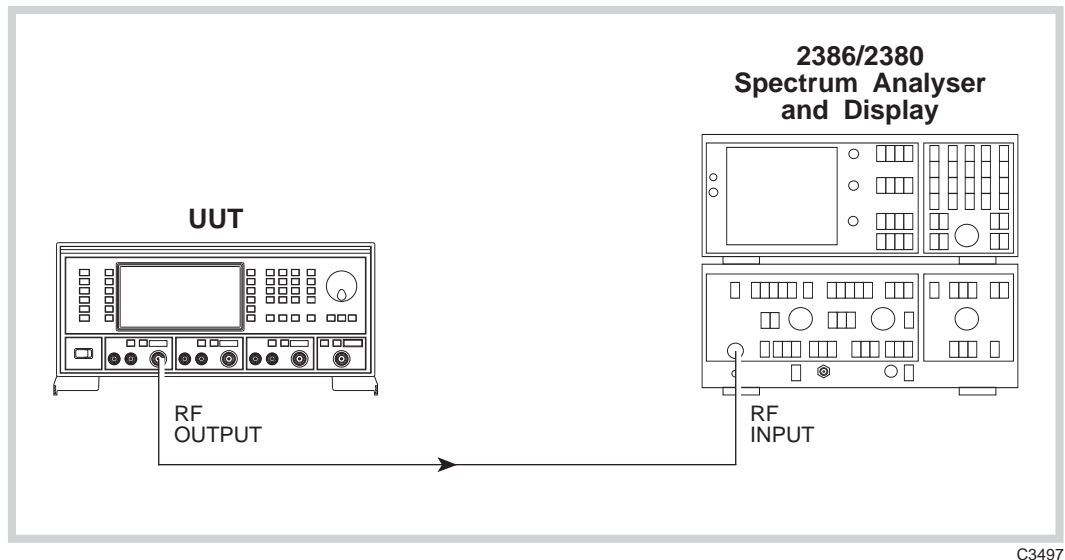

C3497

Fig. 7-4 Carrier harmonics and non-harmonics test set-up

- (1) Press CAL on the spectrum analyzer.
- (2) Connect the test equipment as shown in Fig. 7-4.
- (3) On the UUT set source A to:

[Carrier Freq]	10 [kHz]
[RF Level]	-4 [dB]
- (4) Measure the level of the second and third harmonics on the spectrum analyzer at each of the carrier frequencies shown in Table 7-18, checking that the results are within specification.
- (5) Set the UUT RF level to 0 dBm and repeat (4) using Table 7-19.
- (6) Set the UUT RF level to +7 dBm and repeat (4) using Table 7-20.
- (7) Set the UUT RF level to +18 dBm and repeat (4) using Table 7-21.
- (8) Repeat (3) to (7) for source B and, if Option 1 is fitted, source C.

Non-harmonics

Test procedure

- (1) Press CAL on the spectrum analyzer.
- (2) Connect the test equipment as shown in Fig. 7-4.
- (3) On the UUT set source A to:

[Carrier Freq]	1201 [MHz]
[RF Level]	0 [dB]
- (4) Measure the level of the non-harmonics on the spectrum analyzer at each of the carrier frequencies shown in Table 7-22, checking that the results are within specification.
- (5) Repeat (3) to (4) for source B and, if Option 1 is fitted, source C.

Residual FM

Test procedure

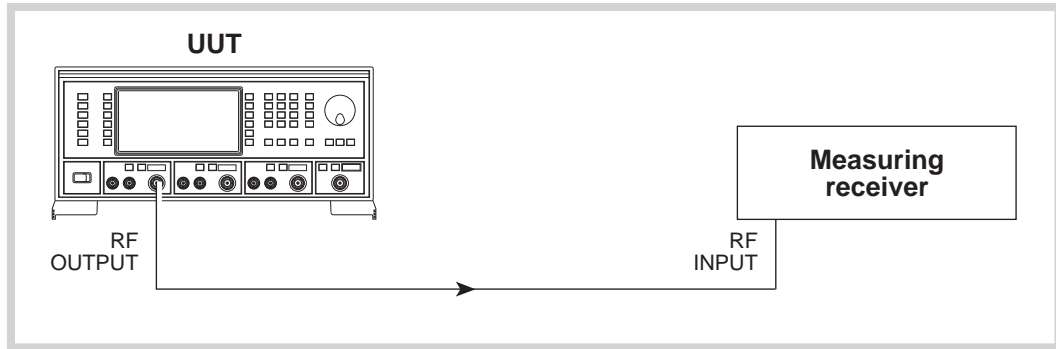

C3498

Fig. 7-5 Residual FM test set-up

- (1) Connect the test equipment as shown in Fig. 7-5.
- (2) On the UUT set source A to:

[Carrier Freq]	1 [GHz]
[RF Level]	0 [dB]
- (3) On the measuring receiver, select FM, 300 Hz high-pass filter, 3.4 kHz low-pass filter and enable averaging.
- (4) Measure the residual FM, checking that the result is within the specification shown in Table 7-23.
- (5) Repeat (3) to (4) for source B and, if Option 1 is fitted, source C.

SSB phase noise

Test procedure

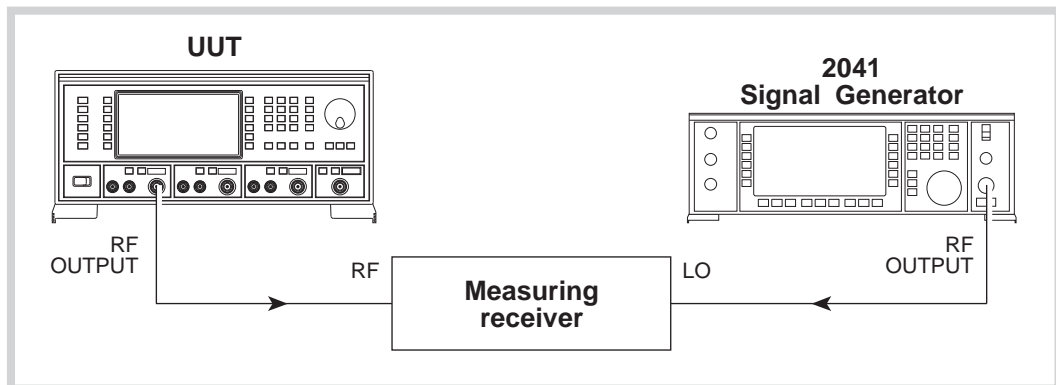

C3499

Fig. 7-6 SSB phase noise test set-up

- (1) Connect the test equipment as shown in Fig. 7-6.
- (2) On the UUT set source A to:

[Carrier Freq]	470 [MHz]
[RF Level]	0 [dB]
- (3) On the measuring receiver:
 - Tune the receiver to 470 MHz.

- Select 24.0 SPCL to enter selective power measurement mode.
Select 23.1 SPCL to set the LO to external.
- (4) Set the signal generator to a carrier frequency of 470.455 MHz, RF level 0 dBm.
 - (5) On the measuring receiver:
 - Select 24.5 SPCL to establish the IF reference value (in volts).
 - Select 24.6 SPCL to set the reference to 0 dBm.
 - (6) Fine-tune the signal generator frequency until a maximum value is displayed on the measuring receiver.
 - (7) Offset the signal generator by 20 kHz.
 - (8) On the measuring receiver:
 - Select 24.7 SPCL to normalize the measurement for a 1 Hz bandwidth.
 - (9) Measure the level on the receiver (the SSB phase noise in a 1 Hz bandwidth), checking that the result is within the specification shown in Table 7-24.
 - (10) Repeat (2) to (9) for source B and, if Option 1 is fitted, source C.

RF leakage

Test procedure

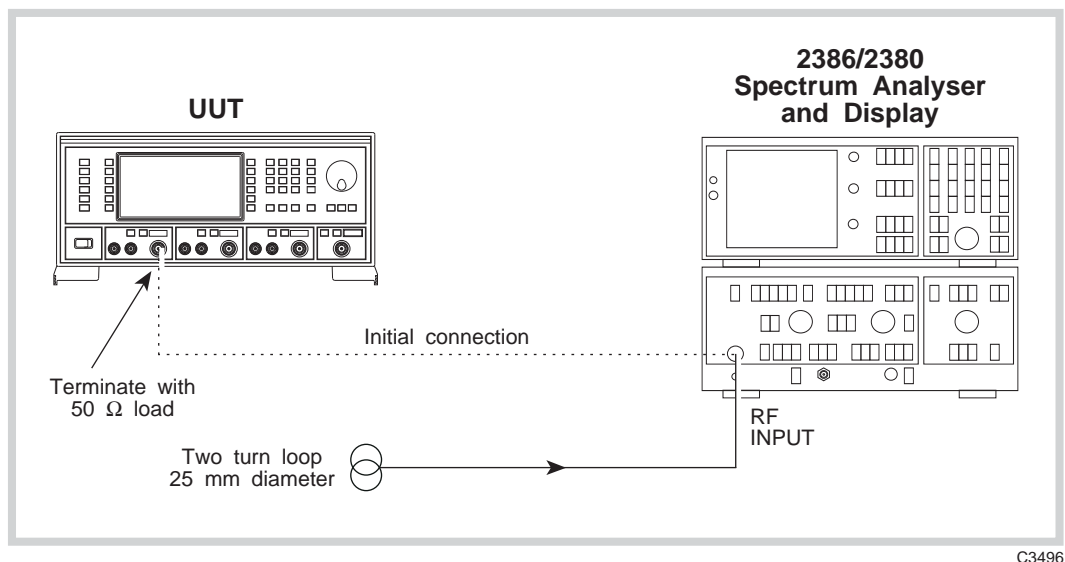

C3496

Fig. 7-7 RF leakage test set-up

- (1) Press PRESET then CAL on the spectrum analyzer.
- (2) Connect the test equipment as shown in Fig. 7-7.
- (3) On the UUT set source A to:

[Carrier Freq]	469.03 [MHz]
[RF Level]	-30 [dB]
- (4) If using the 2386 Spectrum Analyzer select

REF FREQ	469.03 MHz
SPAN/DIV	10 Hz
PEAK FIND	
MKR 1 SET REF FREQ	
- (5) Disconnect the cable from the UUT RF output socket and place a 25 mm 2-turn loop on the end of the cable.
- (6) Connect a 50 Ω sealed load to the UUT RF output.

- (7) If using the 2386 Spectrum Analyzer select:
 VOLTS/DIV
 REF LEVEL 0.1 μ V
 2nd FUNCT RF ATTEN \Downarrow (to set 0 dB input attenuation)
- (8) Hold the 2-turn loop not less than 25 mm from the UUT at various points around its case ensuring that the worst case leakage indicated on the spectrum analyzer does not exceed that shown in Table 7-25.
- (9) Repeat (3) to (8) for each of the carrier frequencies shown in Table 7-25.
- (10) Repeat (3) to (9) for source B and, if Option 1 is fitted, source C.

Combined RF output

Specification

- Harmonics:** Typically better than -30 dBc for RF levels up to -14 dBm.
 Typically better than -25 dBc for RF levels up to +4 dBm (0 dBm above 1.2 GHz). Unspecified below 1 MHz.
- Isolation:** Better than 80 dB between individual outputs in use.
 Better than 60 dB from a used individual output to the combiner output.
 Better than 40 dB between the combiner output and an unused individual output.
- 2-tone intermodulation:** At an RF level output of 0 dBm on the combiner into a load VSWR of 2:1 or better:
 From 10 MHz to 2.4 GHz, < -80 dBc.
 From 5 MHz to 10 MHz, < -75 dBc.
 Useable but unspecified down to 1 MHz.

Test equipment

Description	Minimum specification	Example
50 Ω load	1 W, 50 Ω nominal impedance, DC to 2.4 GHz	Lucas Weinschel M1404N
T-piece	Precision N-type	
Spectrum analyzer	DC to 2.4 GHz frequency coverage	Anritsu MS2602A

Intermodulation

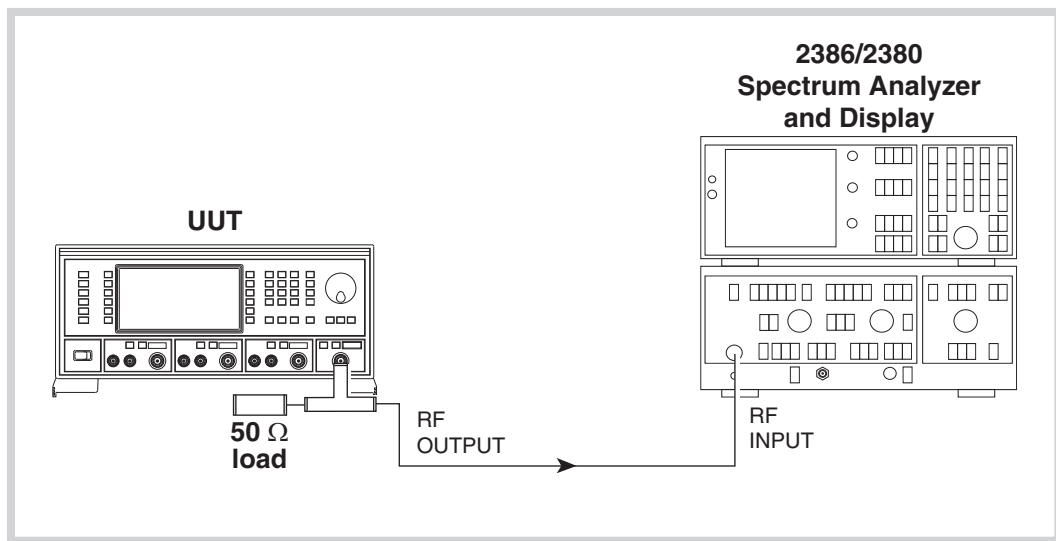

C4697

Fig. 7-8 Combined output intermodulation test set-up

Test procedure

- (1) Connect the test equipment as shown in Fig. 7-8, with the spectrum analyzer connected to the combined RF output via a T-piece. The 50 Ω load presents a 2:1 source VSWR.
- (2) On the UUT set source A to:

<i>[Carrier Freq]</i>	5.001 [MHz]	
<i>[RF Level]</i>	0 [dB]	

 Set source B to:

<i>[Carrier Freq]</i>	5.008 [MHz]	(7 kHz spacing)
<i>[RF Level]</i>	0 [dB]	

 [SET UP]
 [Combiner Set-up]
 [A O/P / Σ]
 [B O/P / Σ]
 [EXIT]
 [SIG GEN]
- (3) Measure the level of the third-order intermodulation products on the spectrum analyzer at the frequencies shown in Table 7-26.
- (4) Repeat (2) to (3) for each of the carrier frequencies shown in Table 7-26.
- (5) Set the RF levels on sources A and B to -14 dBm and repeat (2) to (4).
- (6) If Option 1 is fitted, repeat (2) to (5) with sources A and C using Table 7-27.
- (7) If Option 1 is fitted, repeat (2) to (5) with sources B and C using Table 7-28.

Isolation**Test procedure**

This procedure tests the isolation between any individual output set to 0 dBm and the combined output. The other areas of the isolation specification are tested implicitly by this procedure.

- (1) Connect the test equipment as shown in Fig. 7-4 with the spectrum analyzer connected to the combined RF output.
- (2) On the UUT set source A to:

<i>[Carrier Freq]</i>	800 [MHz]
<i>[RF Level]</i>	0 [dB]

 Terminate source A with the 50 Ω termination.
 Ensure source B (and source C, if Option 1 is fitted) is turned off or set to -137 dBm.
- (3) Set the spectrum analyzer to 800 MHz.
- (4) Measure the isolation on the spectrum analyzer at the carrier frequencies shown in Table 7-29, checking that the results are within specification.
- (5) Repeat (2) to (4) for source B, terminating source B with 50 Ω , disabling source A (and source C, if Option 1 is fitted) using Table 7-29.
- (6) If Option 1 is fitted, repeat (2) to (4) using Table 7-29 for source C, terminating source C with 50 Ω and disabling sources A and B.

Internal FM

Specification

Deviation range:	0 to 100 kHz.
Resolution:	3 digits or 1 Hz.
Bandwidth (1 dB):	DC to 100 kHz (DC coupled). 10 Hz to 100 kHz (AC coupled). 20 Hz to 100 kHz (AC coupled with ALC).
Accuracy:	±5% at 1 kHz modulation rate.
Carrier error:	Less than 1% of the set frequency deviation when DC coupled.
Distortion:	Less than 1% at 1 kHz rate for deviations up to 100 kHz. Typically not greater than 0.3% at 1 kHz rate for deviations up to 10 kHz. Less than 3% at 1 kHz rate and deviations up to 100 kHz for carrier frequencies less than 50 MHz.
External modulation input:	1 V RMS for set deviation.
Modulation ALC:	Levels the applied external modulation over the range 0.75 to 1.25 V RMS.
FSK:	Accepts logic level inputs (1 or 2) to produce an unfiltered FSK modulated output.

Test equipment

Description	Minimum specification	Example
Modulation meter	FM accuracy ±1% at 1 kHz modulation frequency	IFR 2305 with Distortion Option
DVM	DC voltage measurement	Solartron 7150+
50 Ω load (termination)	1 W, 50 Ω nominal impedance, DC to 2.4 GHz	Lucas Weinschel M1404N
Audio analyzer	Capable of measuring THD of 0.01% from 100 Hz to 20 kHz	Rohde & Schwarz UPA3
Function generator	DC to 100 kHz sine, ±0.6 dB flatness	Agilent 3325B

FM deviation and distortion

Test procedure

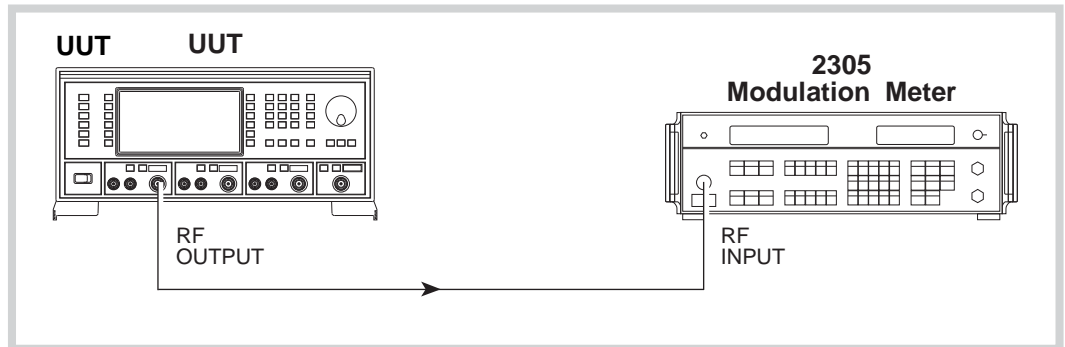

C3488

Fig. 7-9 Internal modulation and modulation distortion test set-up

- (1) Connect the test equipment as shown in Fig. 7-9.
- (2) On the UUT set source A to:

[Carrier Freq]	10 [MHz]
[RF Level]	0 [dB]
[FM Devn]	100 [kHz]
[FM ON/OFF]	
- (3) On the modulation meter, select CAL, FM, 50 Hz \Rightarrow 15 kHz filter.
- (4) Measure the FM accuracy and distortion at the carrier frequencies shown in Table 7-30, checking that the results are within specification.
- (5) Repeat (2) to (4) for source B and, if Option 1 is fitted, source C.

FM scale shape

Test procedure

- (1) Connect the test equipment as shown in Fig. 7-9.
- (2) On the UUT set source A to:

[Carrier Freq]	15 [MHz]
[RF Level]	0 [dB]
[FM Devn]	100 [kHz]
[FM ON/OFF]	
- (3) On the modulation meter, select CAL, FM, 50 Hz \Rightarrow 15 kHz filter.
- (4) Measure the FM accuracy at the deviations shown in Table 7-31, checking that the results are within specification.
- (5) Repeat (2) to (4) for source B and, if Option 1 is fitted, source C.

Carrier error

Test procedure

- (1) Connect the test equipment as shown in Fig. 7-9.
- (2) On the UUT set source A to:

[Carrier Freq]	1200 [MHz]
[RF Level]	0 [dB]
- (3) On the modulation meter select CARRIER ERROR. The FREQUENCY display will read 0.00 kHz.

- (4) On the UUT set source A to:
 - [FM Devn] 100 [kHz]
 - [FM ON/OFF]
 - [UTIL]
 - [Mod'n Mode]

Press [Down] until "FM external" can be selected

 - [Select Mode] [EXIT]
 - [SIG GEN]
 - [Select Coupling] [Ext DC Coupling] [DCFM Nulling] [EXIT]
- (5) On the modulation meter, measure the carrier frequency error displayed in the FREQUENCY window, checking that the result is within the specification shown in Table 7-32.
- (6) Repeat (2) to (5) for source B and, if Option 1 is fitted, source C.

External FM frequency response (ALC off, DC coupled)

Test procedure

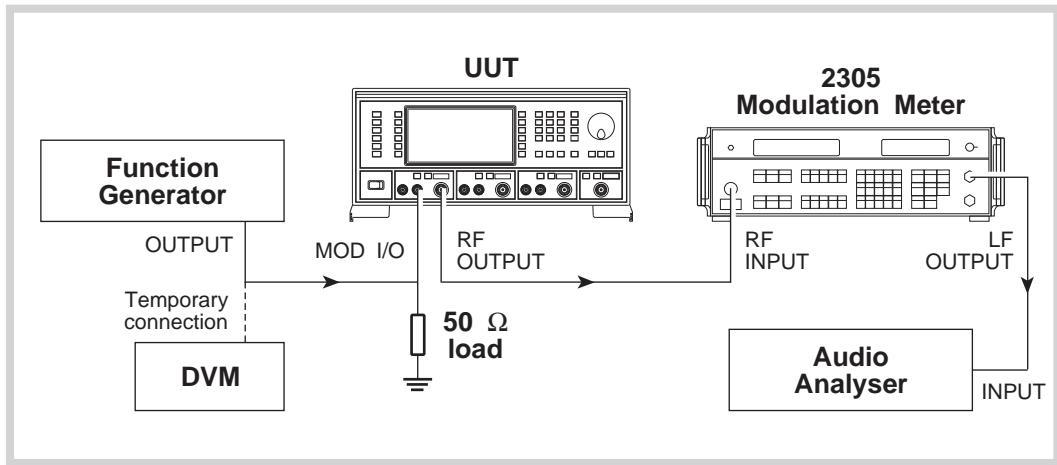

Fig. 7-10 External modulation and modulation distortion test set-up

30 Hz to 100 kHz

- (1) Connect the test equipment as shown in Fig. 7-10.
- (2) On the UUT set source A to:
 - [Carrier Freq] 15 [MHz]
 - [RF Level] 0 [dB]
 - [FM Devn] 100 [kHz]
 - [FM ON/OFF]
 - [UTIL]
 - [Mod'n Mode]

Press [Down] until "FM external" can be selected

 - [Select Mode] [EXIT]
 - [SIG GEN]
 - [Select Coupling] [Ext DC Coupling] [DCFM Nulling] [EXIT]
- (3) Set the function generator to give 1 V RMS, 1 kHz sine wave.
- (4) On the modulation meter, select CAL, FM, 10 Hz ⇒ 300 kHz filter.
- (5) On the modulation meter, check that the FM reading is between 47.5 kHz and 52.5 kHz, then set a reference using the relative function.

- (6) Set the function generator to each of the frequencies shown in Table 7-33, checking that the relative readings on the modulation meter are within specification.
- (7) At those frequencies indicated in Table 7-33, set the modulation meter LF output control to mid-position and measure the AF distortion on the audio analyzer, checking that the results are within specification.

0 Hz (DC)

Note that to measure the FM deviation at DC, it will be necessary to use the DC offset facility on the function generator. Proceed as follows:

- (8) Set the function generator to +1.4142 V DC (temporarily connect the function generator output to the DVM and set this voltage as close as possible to +1.4142 V).
- (9) Press CARRIER ERROR on the modulation meter.
- (10) Set the function generator to –1.4142 V DC (temporarily connect the function generator output to the DVM and set this voltage as close as possible to –1.4142 V).
- (11) Measure the frequency indicated on the modulation meter carrier frequency window.
FM1 _____
- (12) Reset the function generator to 1 V RMS, 1 kHz sine wave and measure the FM deviation.
FM2 _____
- (13) Using the following formula, calculate the change in response checking that the result is within the specification shown against 0 Hz in Table 7-33.

$$20 \log_{10} \frac{FM2}{FM1}$$

- (14) Repeat (2) to (13) for source B and, if Option 1 is fitted, source C.

External FM frequency response (ALC on)

Test procedure

- (1) Connect the test equipment as shown in Fig. 7-10.
- (2) On the UUT set source A to:

<i>[Carrier Freq]</i>	15 [MHz]
<i>[RF Level]</i>	0 [dB]
<i>[FM Devn]</i>	100 [kHz]
<i>[FM ON/OFF]</i>	
<i>[UTIL]</i>	
<i>[Mod'n Mode]</i>	

Press *[Down]* until “FM external” can be selected

<i>[Select Mode]</i>	<i>[EXIT]</i>
<i>[SIG GEN]</i>	
<i>[Select Coupling]</i>	<i>[Ext ALC Coupling]</i>
	<i>[EXIT]</i>
- (3) Set the function generator to give 0.75 V RMS, 1 kHz sine wave.
- (4) On the modulation meter, select CAL, FM, 10 Hz ⇒ 300 kHz filter.
- (5) On the modulation meter, check that the FM reading is between 9.5 kHz and 10.5 kHz, then set a reference using the relative function.
- (6) Set the function generator to each of the frequencies shown in Table 7-34, checking that the relative readings on the modulation meter are within specification.
- (7) Set the function generator to 1.25 V RMS and repeat (4) to (6) using Table 7-35, also measuring the AF distortion on the audio analyzer at those frequencies indicated.
- (8) Repeat (2) to (7) for source B and, if Option 1 is fitted, source C.

Phase modulation

Specification

Range:	0 to 10 radians.
Resolution:	3 digits or 0.01 radians.
Accuracy:	±5% at 1 kHz modulation rate, excluding residual phase modulation.
Bandwidth (3 dB):	100 Hz to 10 kHz.
Distortion:	Less than 3% at 10 radians at 1 kHz modulation rate. Typically less than 0.5% for deviations up to 1 radian at 1 kHz.

Test equipment

Description	Minimum specification	Example
Modulation meter	ΦM and FM accuracy ±2% at 1 kHz modulation frequency	IFR 2305 with Distortion Option

Phase modulation

Test procedure

- Connect the test equipment as shown in Fig. 7-9.
- On the UUT set source A to:

<i>[Carrier Freq]</i>	10.5 [MHz]
<i>[RF Level]</i>	0 [dB]
<i>[ΦM] [ΦM Devn]</i>	10 [rad]
<i>[ΦM ON/OFF]</i>	
- On the modulation meter, select CAL, ΦM.
- Measure the ΦM accuracy and distortion checking that the results are within the specification shown in Table 7-36.
- Repeat (2) to (4) for source B and, if Option 1 is fitted, source C.

Phase modulation flatness

Test procedure

For this test, the phase modulation figures are calculated from readings taken with the modulation meter set to FM. No allowances need to be made for the modulation source's frequency accuracy, since it is derived from the reference oscillator in the UUT.

- Connect the test equipment as shown in Fig. 7-9.
- On the UUT set source A to:

<i>[Carrier Freq]</i>	15 [MHz]
<i>[RF Level]</i>	0 [dB]
<i>[ΦM] [ΦM Devn]</i>	10 [rad]
<i>[ΦM ON/OFF]</i>	
- On the modulation meter, select CAL, FM, 50 Hz ⇒ 15 kHz LF filter.
- Measure the deviation on the modulation meter and calculate the phase modulation using the formula:

$$\Phi M = \frac{\text{FM dev}}{\text{mod freq}} \quad \begin{matrix} \text{(Hz)} \\ \text{(Hz)} \end{matrix}$$

- (5) On the UUT set [Φ Mod Freq] to each of the frequencies shown in Table 7-37, measure the deviation on the modulation meter and calculate the phase modulation for each step using the formula in (4).
- (6) Using the figure recorded in (4) as a reference, calculate the change in response at each modulation frequency using the formula:

$$20 \log_{10} \frac{\text{Figure recorded in (5)}}{\text{Figure recorded in (4)}}$$

Check that the results are within the specifications shown in Table 7-37.

- (7) Repeat (2) to (6) for source B and, if Option 1 is fitted, source C.

Amplitude modulation

Specification

Individual outputs	For carrier frequencies <500 MHz, usable to 1.5 GHz.
Combined output	Unspecified below 5 MHz; usable to 1 MHz. Otherwise as for individual outputs.
Range:	0 to 99.9%
Resolution:	0.1%
Accuracy:	±5% of set depth at 1 kHz modulation rate for output levels not exceeding +10 dBm (−4 dBm at combiner output).
Bandwidth (1 dB):	DC to 30 kHz (DC coupled). 10 Hz to 30 kHz (AC coupled). 20 Hz to 30 kHz (AC coupled with ALC).
Distortion:	For modulation depths up to 30%, less than 1.5% at 1 kHz rate; for modulation depths up to 80%, less than 2.5% at 1 kHz rate, for output levels not exceeding +10 dBm (−4 dBm at combiner output).
ΦM on AM:	Typically 0.1 radians at 30% depth at 470 MHz.

Test equipment

Description	Minimum specification	Example
Modulation meter	AM accuracy ±1% at 1 kHz modulation frequency	IFR 2305 with Distortion Option
DVM	DC voltage measurement	Solartron 7150+
50 Ω load (termination)	1 W, 50 Ω nominal impedance, DC to 2.4 GHz	Lucas Weinschel M1404N
Audio analyzer	Capable of measuring THD of 0.01% from 100 Hz to 20 kHz	Rohde & Schwarz UPA3
Function generator	DC to 30 kHz sine, ±0.6 dB flatness	Agilent 3325B

AM depth and distortion

Test procedure

- (1) Connect the test equipment as shown in Fig. 7-9.
- (2) On the UUT set source A to:
- | | |
|-----------------|-----------|
| [Carrier Freq] | 1.5 [MHz] |
| [RF Level] | −4 [dB] |
| [AM] [AM Depth] | 30 [%] |
| [AM ON/OFF] | |
- (3) On the modulation meter, select CAL, AM, 300 Hz \Rightarrow 3.4 kHz LF filter.

- (4) Measure the AM accuracy and distortion at the frequencies shown in Table 7-38 checking that the results are within specification.
- (5) Set the UUT to *[AM Depth]* 80% and repeat (4).
- (6) Set the UUT to *[RF Level]* 0 dBm and repeat (4) to (5) using Table 7-39.
- (7) Set the UUT to *[RF Level]* +6 dBm and repeat (4) to (5) using Table 7-40.
- (8) Set the UUT to *[RF Level]* +10 dBm and repeat (4) to (5) using Table 7-41.
- (9) Repeat (2) to (8) for source B and, if Option 1 is fitted, source C.

AM scale shape

Test procedure

- (1) Connect the test equipment as shown in Fig. 7-9.
- (2) On the UUT set source A to:

<i>[Carrier Freq]</i>	100 [MHz]
<i>[RF Level]</i>	0 [dB]
<i>[AM] [AM Depth]</i>	1 [%]
<i>[AM ON/OFF]</i>	
- (3) On the modulation meter, select CAL, AM, 300 Hz \Rightarrow 3.4 kHz LF filter.
- (4) Measure the AM accuracy at the depths shown in Table 7-42, checking that the results are within specification.
- (5) Repeat (2) to (4) for source B and, if Option 1 is fitted, source C.

External AM frequency response (ALC off, DC coupled)

Test procedure

100 Hz to 30 kHz

- (1) Connect the test equipment as shown in Fig. 7-10.
- (2) On the UUT set source A to:

<i>[Carrier Freq]</i>	400 [MHz]
<i>[RF Level]</i>	-4 [dB]
<i>[AM] [AM Depth]</i>	80 [%]
<i>[AM ON/OFF]</i>	
<i>[UTIL]</i>	
<i>[Mod'n Mode]</i>	

Press *[Down]* until "AM external" can be selected

<i>[Select Mode] [EXIT]</i>
<i>[SIG GEN]</i>
<i>[Select Coupling] [Ext DC Coupling] [EXIT]</i>
- (3) Set the function generator to give 1 V RMS, 1 kHz sine wave.
- (4) On the modulation meter, select CAL, AM, 10 Hz \Rightarrow 300 kHz filter.
- (5) On the modulation meter, check that the AM reading is between 76% and 84%, then set a reference using the relative function. Record the absolute reading for use in the formula in (17).
- (6) Set the function generator to each of the frequencies shown in Table 7-43, checking that the relative readings on the modulation meter are within specification.
- (7) Set the UUT RF level to +6 dBm and repeat (3) to (6) using Table 7-44.
- (8) Repeat (2) to (7) for source B and, if Option 1 is fitted, source C.

0 Hz (DC)

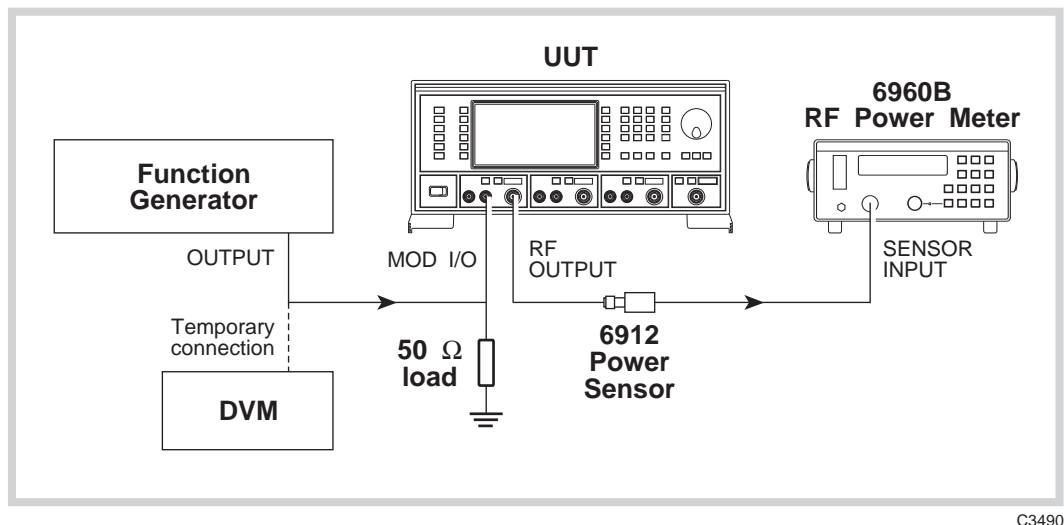

C3490

Fig. 7-11 External AM and distortion test set-up

To measure the AM depth at DC, it will be necessary to use the DC offset facility on the function generator proceeding as follows:

- (9) Connect the test equipment as shown in Fig. 7-11.
- (10) Set the UUT RF level to -4 dBm.
- (11) Set the function generator to $+1.4142$ V DC (temporarily connect the function generator output to the DVM and set this voltage as close as possible to $+1.4142$ V).
- (12) Measure the power on the power meter. P1 _____
- (13) Set the function generator to -1.4142 V DC (temporarily connect the function generator output to the DVM and set this voltage as close as possible to -1.4142 V).
- (14) Measure the power on the power meter. P2 _____
- (15) Subtract P2 from P1 ($= x$).
- (16) Calculate the modulation depth using the formula:

$$AM(\%) = \frac{1 - 10^{(-x/20)}}{1 + 10^{(-x/20)}}$$

- (17) Calculate the 0 Hz response relative to 1 kHz using the following formula, recording the result in Table 7-43:

$$20 \log_{10} \frac{\text{Figure recorded in (5)}}{\text{Figure recorded in (14)}}$$

- (18) Set the UUT RF level to $+6$ dBm and repeat (11) to (18) using Table 7-44.
- (19) Repeat (10) to (18) for source B and, if Option 1 is fitted, source C.

Pulse modulation

Specification

Carrier frequency range:	32 MHz to 2.4 GHz, usable to 10 MHz.
RF level range:	Maximum guaranteed output is reduced by +5 dBm when pulse modulation is selected.
RF level accuracy:	Maximum additional uncertainty is ± 0.5 dB.
On/off ratio:	Better than 45 dB below 1.2 GHz. Better than 40 dB above 1.2 GHz.
Rise and fall time:	Less than 10 μ s.

Test equipment

Description	Minimum specification	Example
Power meter	± 0.1 dB from 10 kHz to 2.4 GHz	IFR 6960B and 6912
Spectrum analyzer	Frequency coverage 32 MHz to 2.4 GHz	IFR 2386 or 2383
50 Ω load (termination)	1 W, 50 Ω nominal impedance, DC to 2.4 GHz	Lucas Weinschel M1404N
Oscilloscope	100 MHz bandwidth	Tektronix TDS 210
Function generator	DC to 10 kHz square wave	Agilent 3325B

Pulse modulation RF level frequency response

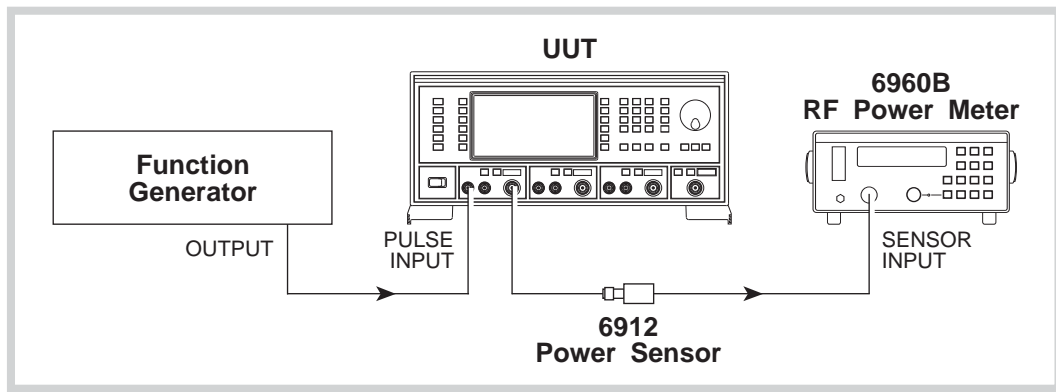

C3489

Fig. 7-12 Pulse modulation test set-up

Test procedure

- (1) Perform AUTO ZERO and AUTO CAL on the power meter.
- (2) Connect the test equipment as shown in Fig. 7-12.

- (3) On the UUT set source A to:

<i>[Carrier Freq]</i>	32 [MHz]
<i>[RF Level]</i>	-7 [dB]
<i>[UTIL]</i>	
<i>[Mod'n Mode] [Pulse Enab/Dis] [EXIT] [SIG GEN]</i>	
<i>[Pulse ON/OFF]</i>	
- (4) Set the function generator to provide +5 V DC. The RF output will now be enabled.
- (5) Record the output level measured by the power meter against each of the carrier frequencies shown in Table 7-45, checking that the results are within specification.
- (6) Set the UUT RF level to +4 dBm and repeat (5) using Table 7-46.
- (7) Repeat (3) to (6) for source B and, if Option 1 is fitted, source C.

Pulse modulation on/off ratio

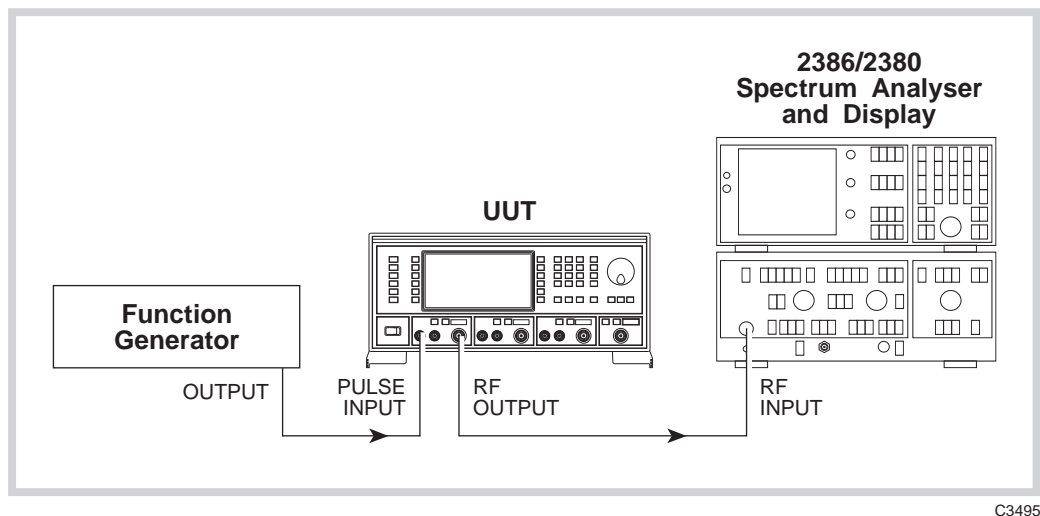

Fig. 7-13 Pulse modulation on/off ratio test set-up

Test procedure

- (1) Press CAL on the spectrum analyzer.
- (2) Connect the test equipment as shown in Fig. 7-13.
- (3) On the UUT set source A to:

<i>[Carrier Freq]</i>	32 [MHz]
<i>[RF Level]</i>	0 [dB]
<i>[UTIL]</i>	
<i>[Mod'n Mode] [Pulse Enab/Dis] [EXIT] [SIG GEN]</i>	
<i>[Pulse ON/OFF]</i>	
- (4) Set the function generator to provide +5 V DC. The RF output will now be enabled.
- (5) Tune the spectrum analyzer to the same frequency as the signal generator.
- (6) Press PEAK FIND on the spectrum analyzer and note the output level.
- (7) Apply a short circuit to the PULSE INPUT socket.
- (8) Again note the output level measured by the spectrum analyzer.
- (9) The difference between the levels recorded in (6) and (8) is the pulse mod on/off ratio. Check that the ratio is within specification using Table 7-47.
- (10) Repeat (5) to (9) for each of the frequencies shown in Table 7-47.
- (11) Repeat (3) to (10) for source B and, if Option 1 is fitted, source C.

Pulse modulation rise and fall time

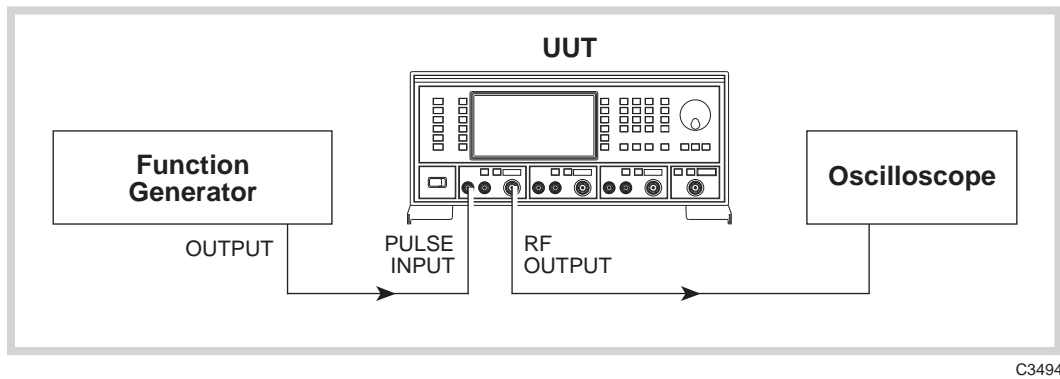

Fig. 7-14 Pulse modulation rise and fall time test set-up

Test procedure

- (1) Connect the test equipment as shown in Fig. 7-14.
- (2) On the UUT set source A to:

[Carrier Freq]	50 [MHz]
[RF Level]	+7 [dB]
[UTIL]	
[Mod'n Mode] [Pulse Enab/Dis] [EXIT] [SIG GEN]	
[Pulse ON/OFF]	
- (3) Set the function generator to produce 10 kHz, 0 V to +5 V square wave.
- (4) Adjust the oscilloscope controls such that the rise time of the envelope can be measured.
- (5) Measure the rise time between the 10% to 90% points, checking that it is within the specification shown in Table 7-48.
- (6) Repeat (4) to (5) for the fall time of the envelope.

Modulation oscillator

Specification

Frequency range:	0.01 Hz to 20 kHz.
Resolution:	0.01 Hz
Frequency accuracy	As frequency standard.
Distortion:	Less than 0.1% at 1 kHz.
Waveforms:	Sine (to 20 kHz), triangle or square wave (to 3 kHz). Square wave jitter <6.4 μ s on any edge.
Output:	2 V RMS EMF from a 600 Ω source impedance.

Test equipment

Description	Minimum specification	Example
Frequency counter	10 kHz to 2.4 GHz	IFR 2440
50 Ω load (termination)	1 W, 50 Ω nominal impedance, DC to 2.4 GHz	Lucas Weinschel M1404N
Audio analyzer	Capable of measuring THD of 0.01% at 1 kHz	Rohde & Schwarz UPA3

Modulation oscillator frequencies

Test procedure

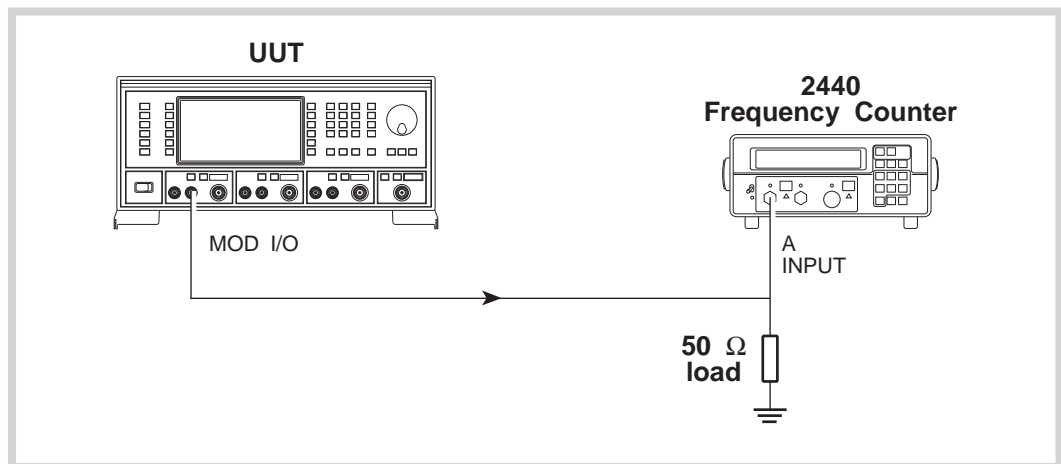

C3502

Fig. 7-15 Modulation oscillator frequency test set-up

- (1) Connect the test equipment as shown in Fig. 7-15.
- (2) On the UUT set source A to:
 - [MOD ON/OFF] (To enable modulation source)
 - [FM Mod Freq] 10 Hz
- (3) Record the frequency measured by the counter against each of the modulation oscillator frequencies shown in Table 7-49.
- (4) Repeat (2) to (3) for source B and, if Option 1 is fitted, source C.

Test procedure

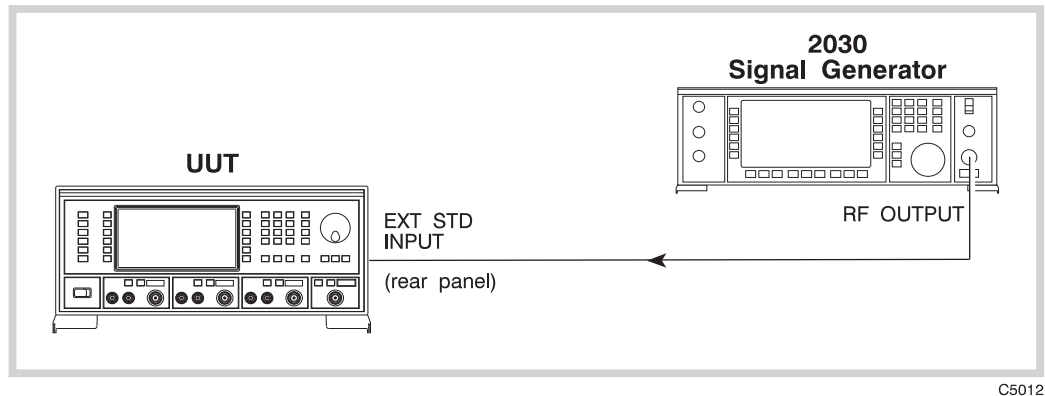

C5012

Fig. 7-17 External standard test set-up

- (1) Connect the test equipment as shown in Fig. 7-17.
- (2) On the UUT set source A to:
[UTIL]
[Freq Standard]
[1MHz Ext Ind]
- (3) Set the signal generator to RF level 220 mV EMF, carrier frequency 1 MHz.
- (4) Using Table 7-51, check that no external standard error messages are displayed on the UUT.
- (5) Set the signal generator to 1.8 V EMF and repeat (4).
- (6) On the UUT select [10MHz Ext Ind].
- (7) Set the signal generator to carrier frequency 10 MHz and repeat (4).
- (8) Set the signal generator to 220 mV and repeat (4).

Acceptance test results tables

For 2026 signal generator, serial number _____ / _____

- Option 1 3rd internal source
 Option 3 High stability frequency standard
 Option 4 Rear-panel output

Table 7-1 RF output at 0 dBm

Carrier frequency (MHz)	RF level min. (dBm)	Result (dBm)			RF level max. (dBm)
		src A	src B	(src C)	
0.03	-0.8	---	---	---	+0.8
0.33	-0.8	---	---	---	+0.8
60	-0.8	---	---	---	+0.8
180	-0.8	---	---	---	+0.8
300	-0.8	---	---	---	+0.8
420	-0.8	---	---	---	+0.8
540	-0.8	---	---	---	+0.8
660	-0.8	---	---	---	+0.8
780	-0.8	---	---	---	+0.8
900	-0.8	---	---	---	+0.8
1020	-0.8	---	---	---	+0.8
1140	-0.8	---	---	---	+0.8
1200	-0.8	---	---	---	+0.8
1201	-1.6	---	---	---	+1.6
1260	-1.6	---	---	---	+1.6
1380	-1.6	---	---	---	+1.6
1500	-1.6	---	---	---	+1.6
1620	-1.6	---	---	---	+1.6
1740	-1.6	---	---	---	+1.6
1860	-1.6	---	---	---	+1.6
1980	-1.6	---	---	---	+1.6
2220	-1.6	---	---	---	+1.6
2340	-1.6	---	---	---	+1.6
2400	-1.6	---	---	---	+1.6

Table 7-2 RF output at +6 dBm

Carrier frequency (MHz)	RF level min. (dBm)	Result (dBm)			RF level max. (dBm)
		src A	src B	(src C)	
0.03	+5.2	---	---	---	+6.8
0.33	+5.2	---	---	---	+6.8
60	+5.2	---	---	---	+6.8
180	+5.2	---	---	---	+6.8
300	+5.2	---	---	---	+6.8
420	+5.2	---	---	---	+6.8
540	+5.2	---	---	---	+6.8
660	+5.2	---	---	---	+6.8
780	+5.2	---	---	---	+6.8
900	+5.2	---	---	---	+6.8
1020	+5.2	---	---	---	+6.8
1140	+5.2	---	---	---	+6.8
1200	+5.2	---	---	---	+6.8
1201	+4.4	---	---	---	+7.6
1260	+4.4	---	---	---	+7.6
1380	+4.4	---	---	---	+7.6
1500	+4.4	---	---	---	+7.6
1620	+4.4	---	---	---	+7.6
1740	+4.4	---	---	---	+7.6
1860	+4.4	---	---	---	+7.6
1980	+4.4	---	---	---	+7.6
2220	+4.4	---	---	---	+7.6
2340	+4.4	---	---	---	+7.6
2400	+4.4	---	---	---	+7.6

Table 7-3 RF output at +13 dBm

Carrier frequency (MHz)	RF level min. (dBm)	Result (dBm)			RF level max. (dBm)
		src A	src B	(src C)	
0.1	+12	_____	_____	_____	+14
0.33	+12	_____	_____	_____	+14
60	+12	_____	_____	_____	+14
180	+12	_____	_____	_____	+14
300	+12	_____	_____	_____	+14
420	+12	_____	_____	_____	+14
540	+12	_____	_____	_____	+14
660	+12	_____	_____	_____	+14
780	+12	_____	_____	_____	+14
900	+12	_____	_____	_____	+14
1020	+12	_____	_____	_____	+14
1140	+12	_____	_____	_____	+14
1200	+12	_____	_____	_____	+14
1201	+11	_____	_____	_____	+15
1260	+11	_____	_____	_____	+15
1380	+11	_____	_____	_____	+15
1500	+11	_____	_____	_____	+15
1620	+11	_____	_____	_____	+15
1740	+11	_____	_____	_____	+15
1860	+11	_____	_____	_____	+15
1980	+11	_____	_____	_____	+15
2220	+11	_____	_____	_____	+15
2340	+11	_____	_____	_____	+15
2400	+11	_____	_____	_____	+15

Table 7-4 RF output at +24 dBm

Carrier frequency (MHz)	RF level min. (dBm)	Result (dBm)			RF level max. (dBm)
		src A	src B	(src C)	
0.1	+23	___	___	___	+25
0.33	+23	___	___	___	+25
60	+23	___	___	___	+25
180	+23	___	___	___	+25
300	+23	___	___	___	+25
420	+23	___	___	___	+25
540	+23	___	___	___	+25
660	+23	___	___	___	+25
780	+23	___	___	___	+25
900	+23	___	___	___	+25
1020	+23	___	___	___	+25
1140	+23	___	___	___	+25
1200	+23	___	___	___	+25
+20 dBm					
1201	+18	___	___	___	+22
1260	+18	___	___	___	+22
1380	+18	___	___	___	+22
1500	+18	___	___	___	+22
1620	+18	___	___	___	+22
1740	+18	___	___	___	+22
1860	+18	___	___	___	+22
1980	+18	___	___	___	+22
2220	+18	___	___	___	+22
2340	+18	___	___	___	+22
2400	+18	___	___	___	+22

Table 7-5 ALC linearity at 2.5 MHz

RF level (dBm)	RF level min. (dBm)	Result (dBm)			RF level max. (dBm)
		src A	src B	(src C)	
-4	-4.8	---	---	---	-3.2
-3	-3.8	---	---	---	-2.2
-2	-2.8	---	---	---	-1.2
-1	-1.8	---	---	---	0.2
0	-0.8	---	---	---	+0.8
1	0.2	---	---	---	+1.8
2	+1.2	---	---	---	+2.8
3	+2.2	---	---	---	+3.8
4	+3.2	---	---	---	+4.8
5	+4.2	---	---	---	+5.8
6	+5.2	---	---	---	+6.8
7	+6	---	---	---	+8
8	+7	---	---	---	+9
9	+8	---	---	---	+10
10	+9	---	---	---	+11
11	+10	---	---	---	+12
12	+11	---	---	---	+13
12.1	+11.1	---	---	---	+13.1
12.2	+11.2	---	---	---	+13.2
12.3	+11.3	---	---	---	+13.3
12.4	+11.4	---	---	---	+13.4
12.5	+11.5	---	---	---	+13.5
12.6	+11.6	---	---	---	+13.6
12.7	+11.7	---	---	---	+13.7
12.8	+11.8	---	---	---	+13.8
12.9	+11.9	---	---	---	+13.9
13	+12	---	---	---	+14
14	+13	---	---	---	+15
15	+14	---	---	---	+16
16	+15	---	---	---	+17
17	+16	---	---	---	+18
18	+17	---	---	---	+19
19	+18	---	---	---	+20
20	+19	---	---	---	+21
21	+20	---	---	---	+22
22	+21	---	---	---	+23
23	+22	---	---	---	+24
24	+23	---	---	---	+25

Table 7-6 ALC linearity at 500 MHz

RF level (dBm)	RF level min. (dBm)	Result (dBm)			RF level max. (dBm)
		src A	src B	(src C)	
-4	-4.8	---	---	---	-3.2
-3	-3.8	---	---	---	-2.2
-2	-2.8	---	---	---	-1.2
-1	-1.8	---	---	---	0.2
0	-0.8	---	---	---	+0.8
1	0.2	---	---	---	+1.8
2	+1.2	---	---	---	+2.8
3	+2.2	---	---	---	+3.8
4	+3.2	---	---	---	+4.8
5	+4.2	---	---	---	+5.8
6	+5.2	---	---	---	+6.8
7	+6	---	---	---	+8
8	+7	---	---	---	+9
9	+8	---	---	---	+10
10	+9	---	---	---	+11
11	+10	---	---	---	+12
12	+11	---	---	---	+13
12.1	+11.1	---	---	---	+13.1
12.2	+11.2	---	---	---	+13.2
12.3	+11.3	---	---	---	+13.3
12.4	+11.4	---	---	---	+13.4
12.5	+11.5	---	---	---	+13.5
12.6	+11.6	---	---	---	+13.6
12.7	+11.7	---	---	---	+13.7
12.8	+11.8	---	---	---	+13.8
12.9	+11.9	---	---	---	+13.9
13	+12	---	---	---	+14
14	+13	---	---	---	+15
15	+14	---	---	---	+16
16	+15	---	---	---	+17
17	+16	---	---	---	+18
18	+17	---	---	---	+19
19	+18	---	---	---	+20
20	+19	---	---	---	+21
21	+20	---	---	---	+22
22	+21	---	---	---	+23
23	+22	---	---	---	+24
24	+23	---	---	---	+25

Table 7-7 ALC linearity at 2400 MHz

RF level (dBm)	RF level min. (dBm)	Result (dBm)			RF level max. (dBm)
		src A	src B	(src C)	
-4	-5.6	---	---	---	-2.4
-3	-4.6	---	---	---	-1.4
-2	-3.6	---	---	---	-0.4
-1	-2.6	---	---	---	+0.6
0	-1.6	---	---	---	+1.6
1	-0.6	---	---	---	+2.6
2	0.4	---	---	---	+3.6
3	+1.4	---	---	---	+4.6
4	+2.4	---	---	---	+5.6
5	+3.4	---	---	---	+6.6
6	+4.4	---	---	---	+7.6
7	+5	---	---	---	+9
8	+6	---	---	---	+10
9	+7	---	---	---	+11
10	+8	---	---	---	+12
11	+9	---	---	---	+13
12	+10	---	---	---	+14
12.1	+10.1	---	---	---	+14.1
12.2	+10.2	---	---	---	+14.2
12.3	+10.3	---	---	---	+14.3
12.4	+10.4	---	---	---	+14.4
12.5	+10.5	---	---	---	+14.5
12.6	+10.6	---	---	---	+14.6
12.7	+10.7	---	---	---	+14.7
12.8	+10.8	---	---	---	+14.8
12.9	+10.9	---	---	---	+14.9
13	+11	---	---	---	+15
14	+12	---	---	---	+16
15	+13	---	---	---	+17
16	+14	---	---	---	+18
17	+15	---	---	---	+19
18	+16	---	---	---	+20
19	+17	---	---	---	+21
20	+18	---	---	---	+22

Table 7-8 Attenuator test at 2.6 MHz

RF level (dBm)	RF level min. (dBm)	Result (dBm)			RF level max. (dBm)
		src A	src B	(src C)	
0	-0.8	___	___	___	+0.8
-4.1	-4.9	___	___	___	-3.3
-15.1	-15.9	___	___	___	-14.3
-26.1	-26.9	___	___	___	-25.3
-37.1	-37.9	___	___	___	-36.3
-48.1	-48.9	___	___	___	-47.3
-59.1	-59.9	___	___	___	-58.3
-70.1	-70.9	___	___	___	-69.3
-81.1	-81.9	___	___	___	-80.3
-92.1	-92.9	___	___	___	-91.3
-103.1	-103.9	___	___	___	-102.3
-114.1	-114.9	___	___	___	-113.3

Table 7-9 Attenuator test at 540.1 MHz

RF level (dBm)	RF level min. (dBm)	Result (dBm)			RF level max. (dBm)
		src A	src B	(src C)	
0	-0.8	___	___	___	+0.8
-4.1	-4.9	___	___	___	-3.3
-15.1	-15.9	___	___	___	-14.3
-26.1	-26.9	___	___	___	-25.3
-37.1	-37.9	___	___	___	-36.3
-48.1	-48.9	___	___	___	-47.3
-59.1	-59.9	___	___	___	-58.3
-70.1	-70.9	___	___	___	-69.3
-81.1	-81.9	___	___	___	-80.3
-92.1	-92.9	___	___	___	-91.3
-103.1	-103.9	___	___	___	-102.3
-114.1	-114.9	___	___	___	-113.3

Table 7-10 Attenuator test at 1140.1 MHz

RF level (dBm)	RF level min. (dBm)	Result (dBm)			RF level max. (dBm)
		src A	src B	(src C)	
0	-0.8	___	___	___	+0.8
-4.1	-4.9	___	___	___	-3.3
-15.1	-15.9	___	___	___	-14.3
-26.1	-26.9	___	___	___	-25.3
-37.1	-37.9	___	___	___	-36.3
-48.1	-48.9	___	___	___	-47.3
-59.1	-59.9	___	___	___	-58.3
-70.1	-70.9	___	___	___	-69.3
-81.1	-81.9	___	___	___	-80.3
-92.1	-92.9	___	___	___	-91.3
-103.1	-103.9	___	___	___	-102.3
-114.1	-114.9	___	___	___	-113.3

Table 7-11 Attenuator test at 1740.1 MHz

RF level (dBm)	RF level min. (dBm)	Result (dBm)			RF level max. (dBm)
		src A	src B	(src C)	
0	-1.6	___	___	___	+1.6
-4.1	-5.7	___	___	___	-2.5
-15.1	-16.7	___	___	___	-13.5
-26.1	-27.7	___	___	___	-24.5
-37.1	-38.7	___	___	___	-35.5
-48.1	-49.7	___	___	___	-46.5
-59.1	-60.7	___	___	___	-57.5
-70.1	-71.7	___	___	___	-68.5
-81.1	-82.7	___	___	___	-79.5
-92.1	-93.7	___	___	___	-90.5
-103.1	-104.7	___	___	___	-101.5
-114.1	-115.7	___	___	___	-112.5

Table 7-12 Attenuator test at 2399 MHz

RF level (dBm)	RF level min. (dBm)	Result (dBm)			RF level max. (dBm)
		src A	src B	(src C)	
0	-1.6	___	___	___	+1.6
-4.1	-5.7	___	___	___	-2.5
-15.1	-16.7	___	___	___	-13.5
-26.1	-27.7	___	___	___	-24.5
-37.1	-38.7	___	___	___	-35.5
-48.1	-49.7	___	___	___	-46.5
-59.1	-60.7	___	___	___	-57.5
-70.1	-71.7	___	___	___	-68.5
-81.1	-82.7	___	___	___	-79.5
-92.1	-93.7	___	___	___	-90.5
-103.1	-104.7	___	___	___	-101.5
-114.1	-115.7	___	___	___	-112.5

Table 7-13 Alternative attenuator functional test at 10 MHz

Attenuator pad	Measured value (dB)		
	src A	src B	(src C)
33 dB	___	___	___
22 dB	___	___	___
33 dB	___	___	___
11 dB	___	___	___
33 dB	___	___	___

Table 7-14 Combined RF output at -18 dBm

	RF level min. (dBm)	Result (dBm) using src A src B (src C)			RF level max. (dBm)
1	-25	—	—	—	-23
11	-25	—	—	—	-23
60	-25	—	—	—	-23
180	-25	—	—	—	-23
300	-25	—	—	—	-23
420	-25	—	—	—	-23
540	-25	—	—	—	-23
660	-25	—	—	—	-23
780	-25	—	—	—	-23
900	-25	—	—	—	-23
1020	-25	—	—	—	-23
1140	-25	—	—	—	-23
1200	-25	—	—	—	-23
1201	-26	—	—	—	-22
1260	-26	—	—	—	-22
1380	-26	—	—	—	-22
1500	-26	—	—	—	-22
1620	-26	—	—	—	-22
1740	-26	—	—	—	-22
1860	-26	—	—	—	-22
1980	-26	—	—	—	-22
2220	-26	—	—	—	-22
2340	-26	—	—	—	-22
2400	-26	—	—	—	-22

Table 7-15 Combined RF output at -13 dBm

Carrier frequency (MHz)	RF level min. (dBm)	Result (dBm) using src A src B (src C)			RF level max. (dBm)
1	-14	___	___	___	-12
11	-14	___	___	___	-12
60	-14	___	___	___	-12
180	-14	___	___	___	-12
300	-14	___	___	___	-12
420	-14	___	___	___	-12
540	-14	___	___	___	-12
660	-14	___	___	___	-12
780	-14	___	___	___	-12
900	-14	___	___	___	-12
1020	-14	___	___	___	-12
1140	-14	___	___	___	-12
1200	-14	___	___	___	-12
1201	-15	___	___	___	-11
1260	-15	___	___	___	-11
1380	-15	___	___	___	-11
1500	-15	___	___	___	-11
1620	-15	___	___	___	-11
1740	-15	___	___	___	-11
1860	-15	___	___	___	-11
1980	-15	___	___	___	-11
2220	-15	___	___	___	-11
2340	-15	___	___	___	-11
2400	-15	___	___	___	-11

Table 7-16 Combined RF output at +4 dBm

Carrier frequency (MHz)	RF level min. (dBm)	Result (dBm) using src A src B (src C)			RF level max. (dBm)
1	-1	___	___	___	+1
11	-1	___	___	___	+1
60	-1	___	___	___	+1
180	-1	___	___	___	+1
300	-1	___	___	___	+1
420	-1	___	___	___	+1
540	-1	___	___	___	+1
660	-1	___	___	___	+1
780	-1	___	___	___	+1
900	-1	___	___	___	+1
1020	-1	___	___	___	+1
1140	-1	___	___	___	+1
1200	-1	___	___	___	+1
0 dBm					
1201	-2	___	___	___	+2
1260	-2	___	___	___	+2
1380	-2	___	___	___	+2
1500	-2	___	___	___	+2
1620	-2	___	___	___	+2
1740	-2	___	___	___	+2
1860	-2	___	___	___	+2
1980	-2	___	___	___	+2
2220	-2	___	___	___	+2
2340	-2	___	___	___	+2
2400	-2	___	___	___	+2

Table 7-17 Carrier frequency tests

Frequency (MHz)	Frequency min. (MHz)	Result (MHz) src A src B (src C)			Frequency max. (MHz)
0.01	-	---	---	---	-
1	-	---	---	---	-
9.999999	-	---	---	---	-
18.75	-	---	---	---	-
37.5	-	---	---	---	-
75	-	---	---	---	-
150	-	---	---	---	-
300	-	---	---	---	-
600	-	---	---	---	-
1200	1199.99988	---	---	---	1200.00012
Instrument fitted with Option 3					
1200	1199.999988	---	---	---	1200.000012
1200.000001	-	---	---	---	-
1230	-	---	---	---	-
1250	-	---	---	---	-
1260	-	---	---	---	-
1320	-	---	---	---	-
1350	-	---	---	---	-
1500	-	---	---	---	-
1599.999999	-	---	---	---	-
2400	-	---	---	---	-

Table 7-18 Carrier harmonic tests at -4 dBm

Carrier frequency (MHz)	2nd harmonic typically (dBc)	Result (dBc)			3rd harmonic typically (dBc)	Result (dBc)		
		src A	src B	(src C)		src A	src B	(src C)
0.01	-30	---	---	---	-30	---	---	---
0.1	-30	---	---	---	-30	---	---	---
1	-30	---	---	---	-30	---	---	---
9.9	-30	---	---	---	-30	---	---	---
10	-30	---	---	---	-30	---	---	---
18.7	-30	---	---	---	-30	---	---	---
18.8	-30	---	---	---	-30	---	---	---
37.4	-30	---	---	---	-30	---	---	---
37.6	-30	---	---	---	-30	---	---	---
74.9	-30	---	---	---	-30	---	---	---
75.1	-30	---	---	---	-30	---	---	---
150	-30	---	---	---	-30	---	---	---
151	-30	---	---	---	-30	---	---	---
300	-30	---	---	---	-30	---	---	---
301	-30	---	---	---	-30	---	---	---
600	-30	---	---	---	-30	---	---	---
601	-30	---	---	---	-30	---	---	---
750	-30	---	---	---	-30	---	---	---
950	-30	---	---	---	-30	---	---	---
1200	-30	---	---	---	-30	---	---	---
1201	-30	---	---	---	-30	---	---	---
1500	-30	---	---	---	-30	---	---	---
1900	-30	---	---	---	-30	---	---	---
2400	-30	---	---	---	-30	---	---	---

Table 7-19 Carrier harmonic tests at 0 dBm

Carrier frequency (MHz)	2nd harmonic typically (dBc)	Result (dBc)			3rd harmonic typically (dBc)	Result (dBc)		
		src A	src B	(src C)		src A	src B	(src C)
0.01	-30	---	---	---	-30	---	---	---
0.1	-30	---	---	---	-30	---	---	---
1	-30	---	---	---	-30	---	---	---
9.9	-30	---	---	---	-30	---	---	---
10	-30	---	---	---	-30	---	---	---
18.7	-30	---	---	---	-30	---	---	---
18.8	-30	---	---	---	-30	---	---	---
37.4	-30	---	---	---	-30	---	---	---
37.6	-30	---	---	---	-30	---	---	---
74.9	-30	---	---	---	-30	---	---	---
75.1	-30	---	---	---	-30	---	---	---
150	-30	---	---	---	-30	---	---	---
151	-30	---	---	---	-30	---	---	---
300	-30	---	---	---	-30	---	---	---
301	-30	---	---	---	-30	---	---	---
600	-30	---	---	---	-30	---	---	---
601	-30	---	---	---	-30	---	---	---
750	-30	---	---	---	-30	---	---	---
950	-30	---	---	---	-30	---	---	---
1200	-30	---	---	---	-30	---	---	---
1201	-30	---	---	---	-30	---	---	---
1500	-30	---	---	---	-30	---	---	---
1900	-30	---	---	---	-30	---	---	---
2400	-30	---	---	---	-30	---	---	---

Table 7-20 Carrier harmonic tests at +7 dBm

Carrier frequency (MHz)	2nd harmonic typically (dBc)	Result (dBc)			3rd harmonic typically (dBc)	Result (dBc)		
		src A	src B	(src C)		src A	src B	(src C)
0.1	-25	—	—	—	-25	—	—	—
1	-25	—	—	—	-25	—	—	—
9.9	-25	—	—	—	-25	—	—	—
10	-25	—	—	—	-25	—	—	—
18.7	-25	—	—	—	-25	—	—	—
18.8	-25	—	—	—	-25	—	—	—
37.4	-25	—	—	—	-25	—	—	—
37.6	-25	—	—	—	-25	—	—	—
74.9	-25	—	—	—	-25	—	—	—
75.1	-25	—	—	—	-25	—	—	—
150	-25	—	—	—	-25	—	—	—
151	-25	—	—	—	-25	—	—	—
300	-25	—	—	—	-25	—	—	—
301	-25	—	—	—	-25	—	—	—
600	-25	—	—	—	-25	—	—	—
601	-25	—	—	—	-25	—	—	—
750	-25	—	—	—	-25	—	—	—
950	-25	—	—	—	-25	—	—	—
1200	-25	—	—	—	-25	—	—	—
1201	-25	—	—	—	-25	—	—	—
1500	-25	—	—	—	-25	—	—	—
1900	-25	—	—	—	-25	—	—	—
2400	-25	—	—	—	-25	—	—	—

Table 7-21 Carrier harmonic tests at +18 dBm

Carrier frequency (MHz)	2nd harmonic typically (dBc)	Result (dBc)			3rd harmonic typically (dBc)	Result (dBc)		
		src A	src B	(src C)		src A	src B	(src C)
0.1	-25	---	---	---	-25	---	---	---
1	-25	---	---	---	-25	---	---	---
9.9	-25	---	---	---	-25	---	---	---
10	-25	---	---	---	-25	---	---	---
18.7	-25	---	---	---	-25	---	---	---
18.8	-25	---	---	---	-25	---	---	---
37.4	-25	---	---	---	-25	---	---	---
37.6	-25	---	---	---	-25	---	---	---
74.9	-25	---	---	---	-25	---	---	---
75.1	-25	---	---	---	-25	---	---	---
150	-25	---	---	---	-25	---	---	---
151	-25	---	---	---	-25	---	---	---
300	-25	---	---	---	-25	---	---	---
301	-25	---	---	---	-25	---	---	---
600	-25	---	---	---	-25	---	---	---
601	-25	---	---	---	-25	---	---	---
750	-25	---	---	---	-25	---	---	---
950	-25	---	---	---	-25	---	---	---
1200	-25	---	---	---	-25	---	---	---
+13 dBm								
1201	-25	---	---	---	-25	---	---	---
1500	-25	---	---	---	-25	---	---	---
1900	-25	---	---	---	-25	---	---	---
2400	-25	---	---	---	-25	---	---	---

Table 7-22 Carrier non-harmonic tests

Carrier frequency (MHz)	Sub-harmonic output			Sub-harmonic output		
	Non-harmonic frequency (MHz)	Non-harmonic level (dBc)	Result (dBc) src A src B (src C)	Non-harmonic frequency (MHz)	Non-harmonic level (dBc)	Result (dBc) src A src B (src C)
1201	800.6667	-64	___ ___ ___	1601.3333	-64	___ ___ ___
1201	400.3333	-64	___ ___ ___	2001.6667	-64	___ ___ ___
1599	1066	-64	___ ___ ___	2132	-64	___ ___ ___
1599	533	-64	___ ___ ___	2665	-64	___ ___ ___
1601	1200.75	-64	___ ___ ___	2001.25	-64	___ ___ ___
1601	800.5	-64	___ ___ ___	2401.5	-64	___ ___ ___
1999	1499.25	-64	___ ___ ___	2498.75	-64	___ ___ ___
1999	999.5	-64	___ ___ ___	2998.5	-64	___ ___ ___
2001	1600.8	-60	___ ___ ___	2401.2	-60	___ ___ ___
2001	1200.6	-60	___ ___ ___	2801.4	-60	___ ___ ___
2400	1920	-60	___ ___ ___	2880	-60	___ ___ ___
2400	1440	-60	___ ___ ___	3360	-60	___ ___ ___
9.9	100.000032	-70	___ ___ ___	109.900036	-70	___ ___ ___

Table 7-23 Residual FM test

Carrier frequency	Residual FM	Measured value (Hz RMS)		
		src A	src B	(src C)
1 GHz	<4.5 Hz RMS	___	___	___

Table 7-24 SSB phase noise test

Carrier frequency	SSB phase noise at 20 kHz offset	Measured value (dBc/Hz)		
		src A	src B	(src C)
470 MHz	<-124 dBc/Hz	___	___	___

Table 7-25 RF leakage test

Carrier frequency (MHz)	RF leakage	Measured value (dBm)		
		src A	src B	(src C)
469	<0.5 μ V	_____	_____	_____
929	<0.5 μ V	_____	_____	_____
1349	<0.5 μ V	_____	_____	_____
2399	<0.5 μ V	_____	_____	_____

Table 7-26 Sources A/B intermod test

RF level (dBm)	Source A frequency (MHz)	Source B frequency (MHz)	Spacing (kHz)	Lower IP frequency (MHz)	Upper IP frequency (MHz)	IP level (dBc)	Result (dBc)	
							Upper	Lower
0	5.001	5.008	7	4.994	5.015	-75	_____	_____
0	25.5	25.507	7	25.493	25.514	-80	_____	_____
0	800	800.007	7	799.993	800.014	-80	_____	_____
0	1000	1000.007	7	999.993	1000.014	-80	_____	_____
0	2000	2000.007	7	1999.993	2000.014	-80	_____	_____
0	2397	2397.007	7	2396.993	2397.014	-80	_____	_____
-14	5.001	5.008	7	4.994	5.015	-75	_____	_____
-14	25.5	25.507	7	25.493	25.514	-80	_____	_____
-14	800	800.007	7	799.993	800.014	-80	_____	_____
-14	1000	1000.007	7	999.993	1000.014	-80	_____	_____
-14	2000	2000.007	7	1999.993	2000.014	-80	_____	_____
-14	2397	2397.007	7	2396.993	2397.014	-80	_____	_____

Table 7-27 Sources A/C intermod test (Option 1 only)

RF level (dBm)	Source A frequency (MHz)	Source C frequency (MHz)	Spacing (kHz)	Lower IP frequency (MHz)	Upper IP frequency (MHz)	IP level (dBc)	Result (dBc) Upper Lower
0	5.001	5.008	7	4.994	5.015	-75	_____
0	25.5	25.507	7	25.493	25.514	-80	_____
0	800	800.007	7	799.993	800.014	-80	_____
0	1000	1000.007	7	999.993	1000.014	-80	_____
0	2000	2000.007	7	1999.993	2000.014	-80	_____
0	2397	2397.007	7	2396.993	2397.014	-80	_____
-14	5.001	5.008	7	4.994	5.015	-75	_____
-14	25.5	25.507	7	25.493	25.514	-80	_____
-14	800	800.007	7	799.993	800.014	-80	_____
-14	1000	1000.007	7	999.993	1000.014	-80	_____
-14	2000	2000.007	7	1999.993	2000.014	-80	_____
-14	2397	2397.007	7	2396.993	2397.014	-80	_____

Table 7-28 Sources B/C intermod test (Option 1 only)

RF level (dBm)	Source B frequency (MHz)	Source C frequency (MHz)	Spacing (kHz)	Lower IP frequency (MHz)	Upper IP frequency (MHz)	IP level (dBc)	Result (dBc) Upper Lower
0	5.001	5.008	7	4.994	5.015	-75	_____
0	25.5	25.507	7	25.493	25.514	-80	_____
0	800	800.007	7	799.993	800.014	-80	_____
0	1000	1000.007	7	999.993	1000.014	-80	_____
0	2000	2000.007	7	1999.993	2000.014	-80	_____
0	2397	2397.007	7	2396.993	2397.014	-80	_____
-14	5.001	5.008	7	4.994	5.015	-75	_____
-14	25.5	25.507	7	25.493	25.514	-80	_____
-14	800	800.007	7	799.993	800.014	-80	_____
-14	1000	1000.007	7	999.993	1000.014	-80	_____
-14	2000	2000.007	7	1999.993	2000.014	-80	_____
-14	2397	2397.007	7	2396.993	2397.014	-80	_____

Table 7-29 Isolation tests

Frequency (MHz)	Isolation level (dBm)	Src B (Src C)		Src A (Src C)		Option 1 only Src A Src B	
800	-60	_____	_____	_____	_____	_____	_____
1200	-60	_____	_____	_____	_____	_____	_____
1600	-60	_____	_____	_____	_____	_____	_____
2000	-60	_____	_____	_____	_____	_____	_____
2400	-60	_____	_____	_____	_____	_____	_____

Table 7-30 Internal FM deviation and distortion tests at 100 kHz deviation

Carrier frequency (MHz)	FM Deviation				Distortion				
	FM deviation min. (kHz)	Result (kHz) src A src B (src C)			FM deviation max. (kHz)	Distortion (%)	Result (%) src A src B (src C)		
10	95	_____	_____	_____	105	<3%	_____	_____	_____
10.144	95	_____	_____	_____	105	<3%	_____	_____	_____
10.292	95	_____	_____	_____	105	<3%	_____	_____	_____
10.441	95	_____	_____	_____	105	<3%	_____	_____	_____
10.592	95	_____	_____	_____	105	<3%	_____	_____	_____
10.746	95	_____	_____	_____	105	<3%	_____	_____	_____
10.901	95	_____	_____	_____	105	<3%	_____	_____	_____
11.059	95	_____	_____	_____	105	<3%	_____	_____	_____
11.22	95	_____	_____	_____	105	<3%	_____	_____	_____
11.382	95	_____	_____	_____	105	<3%	_____	_____	_____
11.547	95	_____	_____	_____	105	<3%	_____	_____	_____
11.714	95	_____	_____	_____	105	<3%	_____	_____	_____
11.884	95	_____	_____	_____	105	<3%	_____	_____	_____
12.056	95	_____	_____	_____	105	<3%	_____	_____	_____
12.23	95	_____	_____	_____	105	<3%	_____	_____	_____
12.5	95	_____	_____	_____	105	<3%	_____	_____	_____
12.587	95	_____	_____	_____	105	<3%	_____	_____	_____
12.77	95	_____	_____	_____	105	<3%	_____	_____	_____
12.995	95	_____	_____	_____	105	<3%	_____	_____	_____
13.143	95	_____	_____	_____	105	<3%	_____	_____	_____
13.333	95	_____	_____	_____	105	<3%	_____	_____	_____

Table 7-31 FM scale shape tests at 15 MHz carrier

FM deviation (kHz)	FM deviation min. (kHz)	Result (kHz)			FM deviation max. (kHz)
		src A	src B	(src C)	
100	95	___	___	___	105
71	67.45	___	___	___	74.55
56	53.2	___	___	___	58.8
44	41.8	___	___	___	46.2
34	32.3	___	___	___	35.7
27	25.65	___	___	___	28.35
21	19.95	___	___	___	22.05
16	15.2	___	___	___	16.8
13	12.35	___	___	___	13.65
11	10.45	___	___	___	11.55
10	9.5	___	___	___	10.5
1	0.95	___	___	___	1.05
0.1	0.095	___	___	___	0.105

Table 7-32 Carrier error test at 1.2 GHz, FM deviation 100 kHz

Carrier error	Result (kHz)		
	src A	src B	(src C)
<1 kHz	___	___	___

Table 7-33 External FM frequency response (ALC off, DC coupled), 50 kHz deviation

Modulation frequency (kHz)	Response level min. (dB)	Result (dB)			Response level max. (dB)	Distortion (%)	Result (%)		
		src A	src B	(src C)			src A	src B	(src C)
0	-1	___	___	___	+1	-	___	___	___
0.03	-1	___	___	___	+1	-	___	___	___
0.1	-1	___	___	___	+1	<3	___	___	___
0.3	-1	___	___	___	+1	-	___	___	___
1	-	reference			-	<3	___	___	___
3	-1	___	___	___	+1	-	___	___	___
5	-1	___	___	___	+1	<3	___	___	___
10	-1	___	___	___	+1	-	___	___	___
20	-1	___	___	___	+1	<3	___	___	___
50	-1	___	___	___	+1	-	___	___	___
100	-1	___	___	___	+1	-	___	___	___

Table 7-34 External FM frequency response (ALC on), 10 kHz deviation, 0.75 V input

Modulation frequency (kHz)	Response level min. (dB)	Result (dB)			Response level max. (dB)
		src A	src B	(src C)	
0.02	-1	___	___	___	+1
0.1	-1	___	___	___	+1
0.3	-1	___	___	___	+1
1	-	reference			-
3	-1	___	___	___	+1
10	-1	___	___	___	+1
30	-1	___	___	___	+1
100	-1	___	___	___	+1

Table 7-35 External FM frequency response (ALC on), 10 kHz deviation, 1.25 V input

Modulation frequency (kHz)	Response level min. (dB)	Result (dB)			Response level max. (dB)	Distortion (%)	Result (%)		
		src A	src B	(src C)			src A	src B	(src C)
0.02	-1	___	___	___	+1	-	-		
0.1	-1	___	___	___	+1	<3	___	___	___
0.3	-1	___	___	___	+1	-	-		
1	-	reference			-	<3	___	___	___
3	-1	___	___	___	+1	-	-		
5	-1	___	___	___	+1	<3	___	___	___
10	-1	___	___	___	+1	-	-		
20	-1	___	___	___	+1	<3	___	___	___
30	-1	___	___	___	+1	-	-		
100	-1	___	___	___	+1	-	-		

Table 7-36 Internal Φ M and distortion test at 10.5 MHz carrier, 10 rad deviation

Φ M deviation				Distortion				
Φ M deviation min. (rad)	Result (rad)			Φ M deviation max. (rad)	Distortion (%)	Result (%)		
	src A	src B	(src C)			src A	src B	(src C)
9.5	___	___	___	10.5	<3%	___	___	___

Table 7-37 Internal FM flatness test

Modulation frequency (kHz)	Response level min. (dB)	Result (dB)			Response level max. (dB)
		src A	src B	(src C)	
0.1	-3	_____	_____	_____	+3
0.3	-3	_____	_____	_____	+3
1	-	reference			-
3	-3	_____	_____	_____	+3
10	-3	_____	_____	_____	+3

Table 7-38 Internal AM depth and distortion tests at -4 dBm

Carr. freq. (MHz)	AM depth 30%			AM depth 80%			Distortion		
	min. (%)	Result (%) src A src B (src C)	max (%)	min. (%)	Result (%) src A src B (src C)	max (%)	Result at 30% depth (<1.5%) src A src B (src C)	Result at 80% depth (<2.5%) src A src B (src C)	
1.5	28.5	_____	31.5	76	_____	84	_____	_____	
5	28.5	_____	31.5	76	_____	84	_____	_____	
9	28.5	_____	31.5	76	_____	84	_____	_____	
11	28.5	_____	31.5	76	_____	84	_____	_____	
20	28.5	_____	31.5	76	_____	84	_____	_____	
50	28.5	_____	31.5	76	_____	84	_____	_____	
100	28.5	_____	31.5	76	_____	84	_____	_____	
200	28.5	_____	31.5	76	_____	84	_____	_____	
500	28.5	_____	31.5	76	_____	84	_____	_____	

Table 7-39 Internal AM depth and distortion tests at 0 dBm

Carr. freq. (MHz)	AM depth 30%			AM depth 80%			Distortion	
	min. (%)	Result (%) src A src B (src C)	max. (%)	min. (%)	Result (%) src A src B (src C)	max. (%)	Result at 30% depth (<1.5%) src A src B (src C)	Result at 80% depth (<2.5%) src A src B (src C)
1.5	28.5	____	31.5	76	____	84	____	____
5	28.5	____	31.5	76	____	84	____	____
9	28.5	____	31.5	76	____	84	____	____
11	28.5	____	31.5	76	____	84	____	____
20	28.5	____	31.5	76	____	84	____	____
50	28.5	____	31.5	76	____	84	____	____
100	28.5	____	31.5	76	____	84	____	____
200	28.5	____	31.5	76	____	84	____	____
500	28.5	____	31.5	76	____	84	____	____

Table 7-40 Internal AM depth and distortion tests at +6 dBm

Carr. freq. (MHz)	AM depth 30%			AM depth 80%			Distortion	
	min. (%)	Result (%) src A src B (src C)	max. (%)	min. (%)	Result (%) src A src B (src C)	max. (%)	Result at 30% depth (<1.5%) src A src B (src C)	Result at 80% depth (<2.5%) src A src B (src C)
1.5	28.5	____ _	31.5	76	____ _	84	____ _	____ _
5	28.5	____ _	31.5	76	____ _	84	____ _	____ _
9	28.5	____ _	31.5	76	____ _	84	____ _	____ _
11	28.5	____ _	31.5	76	____ _	84	____ _	____ _
20	28.5	____ _	31.5	76	____ _	84	____ _	____ _
50	28.5	____ _	31.5	76	____ _	84	____ _	____ _
100	28.5	____ _	31.5	76	____ _	84	____ _	____ _
200	28.5	____ _	31.5	76	____ _	84	____ _	____ _
500	28.5	____ _	31.5	76	____ _	84	____ _	____ _

Table 7-41 Internal AM depth and distortion tests at +10 dBm

Carr. freq. (MHz)	AM depth 30%			AM depth 80%			Distortion		
	min. (%)	Result (%) src A src B (src C)	max. (%)	min. (%)	Result (%) src A src B (src C)	max. (%)	Result at 30% depth (<1.5%) src A src B (src C)	Result at 80% depth (<2.5%) src A src B (src C)	
1.5	28.5	___ ___	31.5	76	___ ___	84	___ ___	___ ___	
5	28.5	___ ___	31.5	76	___ ___	84	___ ___	___ ___	
9	28.5	___ ___	31.5	76	___ ___	84	___ ___	___ ___	
11	28.5	___ ___	31.5	76	___ ___	84	___ ___	___ ___	
20	28.5	___ ___	31.5	76	___ ___	84	___ ___	___ ___	
50	28.5	___ ___	31.5	76	___ ___	84	___ ___	___ ___	
100	28.5	___ ___	31.5	76	___ ___	84	___ ___	___ ___	
200	28.5	___ ___	31.5	76	___ ___	84	___ ___	___ ___	
500	28.5	___ ___	31.5	76	___ ___	84	___ ___	___ ___	

Table 7-42 AM scale shape test

AM depth (%)	AM depth min. (%)	Result (%) src A src B (src C)	AM depth max. (%)
10	9.5	___ ___ ___	10.5
20	19	___ ___ ___	21
30	28.5	___ ___ ___	31.5
40	38	___ ___ ___	42
50	47.5	___ ___ ___	52.5
60	57	___ ___ ___	63
70	66.5	___ ___ ___	73.5
80	76	___ ___ ___	84
85	80.75	___ ___ ___	89.25

Table 7-43 External AM frequency response (ALC off, DC coupled), RF level -4 dBm

Modulation frequency (kHz)	Response level min. (dB)	Result (dB)			Response level max. (dB)
		src A	src B	(src C)	
0	-1	_____	_____	_____	+1
0.1	-1	_____	_____	_____	+1
0.3	-1	_____	_____	_____	+1
1	-	reference			-
10	-1	_____	_____	_____	+1
20	-1	_____	_____	_____	+1
30	-1	_____	_____	_____	+1

Table 7-44 External AM frequency response (ALC off, DC coupled), RF level +6 dBm

Modulation frequency (kHz)	Response level min. (dB)	Result (dB)			Response level max. (dB)
		src A	src B	(src C)	
0	-1	_____	_____	_____	+1
0.1	-1	_____	_____	_____	+1
0.3	-1	_____	_____	_____	+1
1	-	reference			-
10	-1	_____	_____	_____	+1
20	-1	_____	_____	_____	+1
30	-1	_____	_____	_____	+1

Table 7-45 Pulse mod. RF output at -7 dBm

Carrier frequency (MHz)	RF level min. (dBm)	Result (dBm)			RF level max. (dBm)
		src A	src B	(src C)	
32	-8.3	---	---	---	+5.7
60	-8.3	---	---	---	+5.7
180	-8.3	---	---	---	+5.7
300	-8.3	---	---	---	+5.7
420	-8.3	---	---	---	+5.7
540	-8.3	---	---	---	+5.7
660	-8.3	---	---	---	+5.7
780	-8.3	---	---	---	+5.7
900	-8.3	---	---	---	+5.7
1020	-8.3	---	---	---	+5.7
1140	-8.3	---	---	---	+5.7
1200	-8.3	---	---	---	+5.7
1201	-9.1	---	---	---	+4.9
1260	-9.1	---	---	---	+4.9
1380	-9.1	---	---	---	+4.9
1500	-9.1	---	---	---	+4.9
1620	-9.1	---	---	---	+4.9
1740	-9.1	---	---	---	+4.9
1860	-9.1	---	---	---	+4.9
1980	-9.1	---	---	---	+4.9
2220	-9.1	---	---	---	+4.9
2340	-9.1	---	---	---	+4.9
2400	-9.1	---	---	---	+4.9

Table 7-46 Pulse mod. RF output at +4 dBm

Carrier frequency (MHz)	RF level min. (dBm)	Result (dBm)			RF level max. (dBm)
		src A	src B	(src C)	
32	+2.7	_____	_____	_____	+5.3
60	+2.7	_____	_____	_____	+5.3
180	+2.7	_____	_____	_____	+5.3
300	+2.7	_____	_____	_____	+5.3
420	+2.7	_____	_____	_____	+5.3
540	+2.7	_____	_____	_____	+5.3
660	+2.7	_____	_____	_____	+5.3
780	+2.7	_____	_____	_____	+5.3
900	+2.7	_____	_____	_____	+5.3
1020	+2.7	_____	_____	_____	+5.3
1140	+2.7	_____	_____	_____	+5.3
1200	+2.7	_____	_____	_____	+5.3
1201	+1.9	_____	_____	_____	+6.1
1260	+1.9	_____	_____	_____	+6.1
1380	+1.9	_____	_____	_____	+6.1
1500	+1.9	_____	_____	_____	+6.1
1620	+1.9	_____	_____	_____	+6.1
1740	+1.9	_____	_____	_____	+6.1
1860	+1.9	_____	_____	_____	+6.1
1980	+1.9	_____	_____	_____	+6.1
2220	+1.9	_____	_____	_____	+6.1
2340	+1.9	_____	_____	_____	+6.1
2400	+1.9	_____	_____	_____	+6.1

Table 7-47 Pulse modulation on/off ratio test

Carrier frequency (MHz)	Pulse mod. on/off ratio (dB)	Measured value (dB)		
		src A	src B	(src C)
32	>45	_____	_____	_____
100	>45	_____	_____	_____
320	>45	_____	_____	_____
1000	>45	_____	_____	_____
1200	>45	_____	_____	_____
1500	>40	_____	_____	_____
1800	>40	_____	_____	_____
2100	>40	_____	_____	_____
2400	>40	_____	_____	_____

Table 7-48 Pulse modulation rise and fall time test

		Result (μ s)		
		src A	src B	(src C)
Rise time	<10 μ s	___	___	___
Fall time	<10 μ s	___	___	___

Table 7-49 Modulation oscillator frequency tests

Frequency (Hz)	Result (Hz)		
	src A	src B	(src C)
10	___	___	___
100	___	___	___
1000	___	___	___
20000	___	___	___

Table 7-50 Modulation oscillator distortion and LF output tests

Mod. oscillator frequency (Hz)	Response level min. (dB)	Result			Response level max. (dB)	Distortion (%)	Result (%)		
		src A	src B	(src C)			src A	src B	(src C)
10	-1	___	___	___	+1	-	-	-	-
20	-1	___	___	___	+1	-	-	-	-
50	-1	___	___	___	+1	-	-	-	-
100	-1	___	___	___	+1	-	-	-	-
200	-1	___	___	___	+1	-	-	-	-
500	-1	___	___	___	+1	-	-	-	-
1000	-1	reference			-	<0.1%	___	___	___
2000	-1	___	___	___	+1	-	-	-	-
5000	-1	___	___	___	+1	-	-	-	-
10000	-1	___	___	___	+1	-	-	-	-
20000	-1	___	___	___	+1	-	-	-	-

Table 7-51 External frequency standard tests

External signal	Locked [<input checked="" type="checkbox"/>]
1 MHz, 220 mV	[<input type="checkbox"/>]
1 MHz, 1.8 V	[<input type="checkbox"/>]
10 MHz, 220 mV	[<input type="checkbox"/>]
10 MHz, 1.8 V	[<input type="checkbox"/>]

AEROFLEX INTERNATIONAL LTD. SOFTWARE LICENCE AND WARRANTY

This document is an Agreement between the user of this Licensed Software, the Licensee, and Aeroflex International Limited, the Licensor. By opening this Software package or commencing to use the software you accept the terms of this Agreement. If you do not agree to the terms of this Agreement please return the Software package unopened to Aeroflex International Limited or do not use the software.

1. DEFINITIONS

The following expressions will have the meanings set out below for the purposes of this Agreement:

Add-In Application Software	Licensed Software that may be loaded separately from time to time into the Equipment to improve or modify its functionality
Computer Application Software	Licensed Software supplied to run on a standard PC or workstation
Designated Equipment	the single piece of Equipment upon which the licensed software is installed
Downloaded Software	any software downloaded from an Aeroflex web site
Embedded Software	Licensed Software that forms part of the Equipment supplied by Aeroflex and without which the Equipment cannot function
Licence Fee	the consideration ruling at the date of this Agreement for the use of one copy of the Licensed Software on the Designated Equipment
Licensed Software	All and any programs, listings, flow charts and instructions in whole or in part including Add-in, Computer Application, Downloaded and Embedded Software supplied to work with Designated Equipment

2. LICENCE FEE

The Licensee shall pay the Licence Fee to Aeroflex in accordance with the terms of the contract between the Licensee and Aeroflex.

3. TERM

This Agreement shall be effective from the date hereof and shall continue in force until terminated under the provisions of Clause 9.

4. LICENCE

- 4.1 Unless and until terminated, this Licence confers upon the Licensee the non-transferable and non-exclusive right to use the Licensed Software on the Designated Equipment.
- 4.2 The Licensee may not use the Licensed Software on other than the Designated Equipment, unless written permission is first obtained from Aeroflex and until the appropriate additional Licence Fee has been paid to Aeroflex.
- 4.3 The Licensee may not amend or alter the Licensed Software and shall have no right or licence other than that stipulated herein.
- 4.4 The Licensee may make not more than two copies of the Licensed Software (but not the Authoring and Language Manuals) in machine-readable form for operational security and shall ensure that all such copies include Aeroflex's copyright notice, together with any features which disclose the name of the Licensed Software and the Licensee. Furthermore, the Licensee shall not permit the Licensed Software or any part to be disclosed in any form to any third party and shall maintain the Licensed Software in secure premises to prevent any unauthorised disclosure. The Licensee shall notify Aeroflex immediately if the Licensee has knowledge that any unlicensed party possesses the Licensed Software. The Licensee's obligation to maintain confidentiality shall cease when the Licensed Software and all copies have been destroyed or returned. The copyright in the Licensed Software shall remain with Aeroflex. The Licensee will permit Aeroflex at all reasonable times to audit the use of the Licensed Software.
- 4.5 The Licensee will not disassemble or reverse engineer the Licensed Software, nor sub-licence, lease, rent or part with possession or otherwise transfer the whole or any part of the Licensed Software.

5. WARRANTY

- 5.1 Aeroflex certifies that the Licensed Software supplied by Aeroflex will at the time of delivery function substantially in accordance with the applicable Software Product Descriptions, Data Sheets or Product Specifications published by Aeroflex.
 - 5.2 The warranty period (unless an extended warranty for Embedded Software has been purchased) from date of delivery in respect of each type of Licensed Software is:

Embedded Software	12 months
Add-In Application Software	90 days
Computer Application Software	90 days
Downloaded Software	No warranty
 - 5.3 If during the appropriate Warranty Period the Licensed Software does not conform substantially to the Software Product Descriptions, Data Sheets or Product Specifications Aeroflex will provide:
 - 5.3.1 In the case of Embedded Software and at Aeroflex's discretion either a fix for the problem or an effective and efficient work-around.
 - 5.3.2 In the case of Add-In Application Software and Computer Application Software and at Aeroflex's discretion replacement of the software or a fix for the problem or an effective and efficient work-around.
 - 5.4 Aeroflex does not warrant that the operation of any software will be uninterrupted or error free.
-

6 The above Warranty does not apply to:

- 6.1 Defects resulting from software not supplied by Aeroflex, from unauthorised modification or misuse or from operation outside of the specification.
- 6.2 Third party produced Proprietary Software which Aeroflex may deliver with its products, in such case the third party Software Licence Agreement including its warranty terms shall apply.
- 7 The remedies offered above are sole and exclusive remedies and to the extent permitted by applicable law are in lieu of any implied conditions, guarantees or warranties whatsoever and whether statutory or otherwise as to the software all of which are hereby expressly excluded.

8. INDEMNITY

- 8.1 Aeroflex shall defend, at its expense, any action brought against the Licensee alleging that the Licensed Software infringes any patent, registered design, trademark or copyright, and shall pay all Licensor's costs and damages finally awarded up to an aggregate equivalent to the Licence fee provided the Licensee shall not have done or permitted to be done anything which may have been or become any such infringement and shall have exercised reasonable care in protecting the same failing which the Licensee shall indemnify Aeroflex against all claims costs and damages incurred and that Aeroflex is given prompt written notice of such claim and given information, reasonable assistance and sole authority to defend or settle such claim on behalf of the Licensee. In the defence or settlement of any such claim, Aeroflex may obtain for the Licensee the right to continue using the Licensed Software or replace it or modify it so that it becomes non-infringing.
- 8.2 Aeroflex shall not be liable if the alleged infringement:
 - 8.2.1 is based upon the use of the Licensed Software in combination with other software not furnished by Aeroflex, or
 - 8.2.2 is based upon the use of the Licensed Software alone or in combination with other software in equipment not functionally identical to the Designated Equipment, or
 - 8.2.3 arises as a result of Aeroflex having followed a properly authorised design or instruction of the Licensee, or
 - 8.2.4 arises out of the use of the Licensed Software in a country other than the one disclosed to Aeroflex as the intended country of use of the Licensed Software at the commencement of this Agreement.
- 8.3 Aeroflex shall not be liable to the Licensee for any loss of use or for loss of profits or of contracts arising directly or indirectly out of any such infringement of patent, registered design, trademark or copyright.

9. TERMINATION

- 9.1 Notwithstanding anything herein to the contrary, this Licence shall forthwith determine if the Licensee:
 - 9.1.1 As an individual has a Receiving Order made against him or is adjudicated bankrupt or compounds with creditors or as a corporate body, compounds with creditors or has a winding-up order made against it or
 - 9.1.2 Parts with possession of the Designated Equipment.
- 9.2 This Licence may be terminated by notice in writing to the Licensee if the Licensee shall be in breach of any of its obligations hereunder and continue in such breach for a period of 21 days after notice thereof has been served on the Licensee.
- 9.3 On termination of this Agreement for any reason, Aeroflex may require the Licensee to return to Aeroflex all copies of the Licensed Software in the custody of the Licensee and the Licensee shall, at its own cost and expense, comply with such requirement within 14 days and shall, at the same time, certify to Aeroflex in writing that all copies of the Licensed Software in whatever form have been obliterated from the Designated Equipment.

10. THIRD PARTY LICENCES

The software or part thereof may be the proprietary property of third party licensors. In such an event such third party licensors (as referenced on the package or the Order Acknowledgement) and/or Aeroflex may directly enforce the terms of this Agreement and may terminate the Agreement if the Licensee is in breach of the conditions contained herein.

11. EXPORT REGULATIONS

The Licensee undertakes that where necessary the Licensee will conform with all relevant export regulations imposed by the Governments of the United Kingdom and/or the United State of America.

12. NOTICES

Any notice to be given by the Licensee to Aeroflex shall be addressed to:

Aeroflex International Limited, Longacres House, Six Hills Way, Stevenage, SG1 2AN, UK.

13. LAW AND JURISDICTION

This Agreement shall be governed by the laws of England and shall be subject to the exclusive jurisdiction of the English courts. This agreement constitutes the whole Contract between the parties and may be changed only by memorandum signed by both parties.

© AEROFLEX INTERNATIONAL LTD 2004

**CHINA Beijing**

Tel: [+86] (10) 6539 1166
Fax: [+86] (10) 6539 1778

CHINA Shanghai

Tel: [+86] (21) 5109 5128
Fax: [+86] (21) 5150 6112

FINLAND

Tel: [+358] (9) 2709 5541
Fax: [+358] (9) 804 2441

FRANCE

Tel: [+33] 1 60 79 96 00
Fax: [+33] 1 60 77 69 22

GERMANY

Tel: [+49] 8131 2926-0
Fax: [+49] 8131 2926-130

HONG KONG

Tel: [+852] 2832 7988
Fax: [+852] 2834 5364

INDIA

Tel: [+91] 80 5115 4501
Fax: [+91] 80 5115 4502

KOREA

Tel: [+82] (2) 3424 2719
Fax: [+82] (2) 3424 8620

SCANDINAVIA

Tel: [+45] 9614 0045
Fax: [+45] 9614 0047

SPAIN

Tel: [+34] (91) 640 11 34
Fax: [+34] (91) 640 06 40

UK Burnham

Tel: [+44] (0) 1628 604455
Fax: [+44] (0) 1628 662017

UK Stevenage

Tel: [+44] (0) 1438 742200
Fax: [+44] (0) 1438 727601
Freephone: 0800 282388

USA

Tel: [+1] (316) 522 4981
Fax: [+1] (316) 522 1360
Toll Free: (800) 835 2352

As we are always seeking to improve our products, the information in this document gives only a general indication of the product capacity, performance and suitability, none of which shall form part of any contract. We reserve the right to make design changes without notice.

web www.aeroflex.com

Email info-test@aeroflex.com

November 2005