

## PRECISION DC POWER SOURCE

TECHNICAL DATA

MODEL 2020

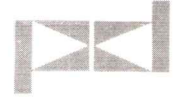

POWER DESIGNS

The Model 2020 is a precision portable laboratory power source with the accuracy and stability performance of a voltage calibrator. Concentric decade switches provide readout to four places up to 10 volts. A toggle switch extends the range to 20 volts and provides an effective five place readout in the 10-20 volt range. A sixth place calibration is achieved by a continuously adjustable potentiometer with a 1 mV range and a resolution of better than 10  $\mu$ V.

A continuously adjustable current limiter permits control of the maximum output current of the supply. A flashing indicator lamp on the front panel indicates operation of the supply in its current limited or non-regulating mode.

Temperature sensitive semiconductors and components are contained in a temperature stabilized oven which operates as long as the power line is energized, providing fast warm-up and freedom from output voltage drift due to semiconductor thermal history phenomena.

Compact and light, the Model 2020 is self-contained in a portable housing designed for laboratory bench use.

### ELECTRICAL SPECIFICATIONS

OUTPUT: 0-20 VDC continuously adjustable, at 0 to 2 A

INPUT: 105-125 and 210-250 VAC at 47 to 440 Hz, 90 watts (nominal)

CALIBRATION ACCURACY: Better than 0.1% +1 mV

REGULATION: Output voltage change less than 100  $\mu$ V (at sense connection points) for line or load variations over the operating range

STABILITY: Better than 0.001% +100  $\mu$ V per 8 hours; better than 0.005% +250  $\mu$ V per week (at constant ambient temperature, load and line voltage after warm-up)

TEMPERATURE COEFFICIENT: DC output voltage change less than 0.001% or 50  $\mu$ V (whichever is greater) per  $^{\circ}$ C over the range of +15 to +45 $^{\circ}$ C; less than 0.002% or 100  $\mu$ V (whichever is greater) per  $^{\circ}$ C from 0 to +15 $^{\circ}$ C and +45 to +60 $^{\circ}$ C

RIPPLE AND NOISE: Less than 100  $\mu$ V peak-to-peak at 50 and 60 Hz operation

SOURCE IMPEDANCE: Less than 0.1 m $\Omega$  at DC, 0.04  $\Omega$  at 20 kHz, 0.5  $\Omega$  at 1 mHz

RECOVERY TIME: Less than 50  $\mu$ sec to return to within 1 mV of the set voltage for a 10% to 100% step change in rated load; less than 100  $\mu$ sec to return to within 100  $\mu$ V

POWER DESIGNS, INC. | POWER DESIGNS PACIFIC, INC.

SERIAL NO: 810075

MODEL 2020

OPERATING TEMPERATURE RANGE: 0 to 50°C ambient

REMOTE PROGRAMMING: The output voltage can be remotely controlled by means of resistance. Programming constant is 1000  $\Omega$  per volt with an accuracy of 0.01% of resistance value (including connecting leads).

REMOTE SENSING: Terminals are provided to regulate the output voltage at the load terminals accurately.

CURRENT LIMITING: The output current can be limited to any value from 0 to 2 A by a front panel control.

OUTPUT POLARITY: Either the positive or negative output terminals may be grounded or both may be left floating. The potential between any output terminal and ground must not exceed 200 V.

INTERFACE CONNECTIONS: Front Panel: Five binding posts provided for output terminals, sensing terminals and chassis ground. Rear Panel: Terminal strip provides connections for output power, remote sensing, remote programming and chassis ground. A three-wire AC line cord is provided for input power.

METER: Front panel volt-ammeter permits monitoring output voltage or current with an accuracy of  $\pm 2\%$ .

#### MECHANICAL SPECIFICATIONS

DIMENSIONS: 5-3/4" x 8-5/8" x 10-7/8"

WEIGHT: 15 lbs.

FINISH: Brushed anodized aluminum panel with etched black lettering. Portable steel cabinet finished in blue vinyl enamel.

# PRECISION DC POWER SOURCE

## MODEL 2020

### SECTION 1 GENERAL DESCRIPTION

#### 1-1. DESCRIPTION

The Model 2020 is a calibrated high stability voltage source adjustable from 0-20 volts at output current levels up to 2 amperes.

Concentric decade switches provide digital readout to four places up to ten volts. A toggle switch extends the range to 20 volts and provides an effective five place readout in the 10-20 volt range. A sixth place calibration is achieved by a continuously adjustable potentiometer with a one millivolt range and a resolution of better than 10 microvolts.

The output voltage of the supply may be remotely programmed with the same calibration accuracy by means of an external resistance.

A continuously adjustable current limiter permits control of the maximum output current of the supply. A flashing indicator lamp on the front panel indicates operation of the supply in its current limited or non-regulating mode.

Temperature sensitive semiconductors and components are contained in a temperature stabilized oven which operates as long as the power line is energized, providing fast warm-up and freedom from output voltage drift due to semiconductor thermal history phenomena.

Provision is made for sensing the output voltage at the load to eliminate the regulation drop due to connecting lead resistance between the source and the load.

Compact and light, the Model 2020 is self-contained in a portable housing designed for laboratory bench use. Modular construction permits rack mounting up to three units in a standard 19" rack. Suitable panel adapters having a panel height of 8-3/4" are available.

#### 1-2. ELECTRICAL SPECIFICATIONS

Table 1 lists the electrical specifications of the Model 2020.

#### 1-3. MECHANICAL SPECIFICATIONS

Dimensions: 5-3/4" x 8-5/8" x 10-7/8" deep behind front panel

Weight: 15 pounds

Finish: The panel is finished in brushed anodized aluminum and has etched black lettering. The housing is finished in blue vinyl enamel.

TABLE 1. ELECTRICAL SPECIFICATIONS

Parameter	Value
Output	0-20 vdc continuously adjustable, at 0 to 2 amperes
Input	105-125 VAC and 210-250 VAC at 50 to 440 Hz, 90 watts (nominal)
Calibration Accuracy	Better than 0.1% +1 mV
Regulation	Output voltage change is less than 100 microvolts for line or load variations over the operating range at rear terminals or at the junction of the load and remote sensing leads. Load regulation at the front panel terminals is somewhat poorer due to the binding post resistance.
Temperature Coefficient	DC output voltage change less than 0.001% or 50 microvolts (whichever is greater) per °C over the range of +15 to +45°C; less than 0.002% or 100 microvolts (whichever is greater) per °C from 0 to +15°C and +45°C to 60°.
Ripple and Noise	Less than 100 microvolts peak-to-peak at 50-60 Hz operation (AC line frequency)
Source Impedance	Less than 0.0001 ohms at DC, 0.04 ohms at 20 kHz, 0.5 ohms at 1 MHz.
Recovery Time	Less than 50 microseconds to return to within 1 mV of the set voltage for a 10% to 100% step change in rated load; less than 100 microseconds to return to within 100 microvolts.
Stability	Better than 0.001% +100 microvolts per 8 hours; better than 0.005% +250 microvolts per week (at constant ambient temperature, load and line voltage after warm-up).
Operating Temperature Range	0 to 60°C ambient
Remote Programming	The output voltage can be remotely controlled by means of an external resistance. Programming constant is 1000 ohms per volt. The programming accuracy is better than 0.01% of resistance value (including connecting lead resistance).
Remote Sensing	Rear terminals are provided to permit accurate control of the output voltage at the load.



Remote Sensing	Rear terminals are provided to permit accurate control of the output voltage at the load.
Current Limiting	The output current can be limited to any value from 0 to 2 amperes by a front panel control. A flashing indicator lamp signals operation of the limiter circuit.
Output Polarity	Either positive or negative output terminals may be grounded or both may be left floating. The potential between any output terminal and ground must not exceed 200 volts.
Output Connections	Front Panel: 3 binding posts are provided for output terminals: DC+, DC- and chassis ground. Rear Panel: Screw terminal block provides connections for output power, remote sensing, remote programming and chassis ground. A three wire AC line cord is provided for input power.
Metering	Front-panel volt-ammeter permits monitoring output voltage or current with an accuracy of $\pm 2\%$ of full scale.

SECTION 2  
INSTALLATION AND OPERATION

## 2-1. INSTALLATION

a. Laboratory Bench. The Model 2020 is a portable unit designed for bench use. No preliminary processing or special unpacking procedures are required. The power source is ready for operation as shipped from the factory.

b. Rack Mounting. Panel adapters are available for mounting one or two units in a standard 19-inch relay rack. Hardware kits are provided with each panel adapter. The power source is fastened to the rear surface of the adapter with the black anodized rivnuts in each corner of its front panel. If the rubber bumper feet interfere with the assembly of the equipment to the rack, they may be removed.

## 2-2. OPERATION

a. (1) Be sure that the power source is turned off and the shorting links are connected between these rear-panel terminals: DC+ and S+; RV1 and RV2; S- and DC-. The screws holding these links should be secure.

(2) Set the CURRENT LIMIT ADJ control fully clockwise.

(3) Connect the AC line cord to a source of 105 to 125 volts, 50 to 40 Hz. For 210-250 volt operation see diagrams in Appendix of this manual.

NOTE: The OVEN indicator will normally light as soon as line voltage is applied to the unit, even when the power source is turned off. The indicator will remain illuminated until the oven reaches operating temperature (approximately 10 minutes). The indicator will then cycle on and off as the oven maintains a constant temperature environment for critical circuit components.

(4) Read the information in paragraphs b through e to connect for remote sensing, series operation, remote programming of the output voltage, or current limiting.

(5) Set the AC switch to ON.

(6) Set the output voltage to the desired value, using the front panel dials. Set the VERNIER control to zero if interpolation between 1 millivolt steps is not desired.

(7) Connect the DC+ and DC- terminals (on the front or rear panel) across the load. If desired, connect the positive or negative output terminal to ground.

b. Sensing. The regulator circuit maintains the potential between the sense leads (S+ and S-) and the set output voltage. When these leads are connected to the positive and negative output terminals, the power source is connected for local sensing (rear terminal links). When the sense leads are connected to the load, the source is connected for remote sensing. Remote sensing is used when an appreciable voltage drop is anticipated in the leads connecting the positive and negative output terminals to the load. The Model 2020 is connected for local sensing when shipped from the factory.

For remote sensing:

(1) With the power supply turned off, remove the shorting links from between the rear panel DC+ and S+ terminals and from between the DC- and S- terminals.

(2) Connect the DC+ and DC- leads across the load.

(3) Connect the S+ and S- leads to the positive and negative sides of the load, respectively. It is desirable to run the sense leads as a tightly twisted, shielded pair. Connect the shield to the G (chassis ground) terminal to minimize output ripple.

c. Series Operation. As many as four Model 2020 units may be connected in series to provide up to 800 volts. Connect the positive DC output terminal of one supply to the negative output terminal of the next, in the same manner as connecting batteries in series. The ground terminals on all units may be left floating or they may be tied together and connected to either the most positive or most negative output terminal.

To ensure optimum voltage regulation, disconnect the shorting links between all S+ and DC+ output terminals except those at the most positive potential. Then connect jumper wire between each S+ and S- terminal on the next more positive power source. In this way the voltage drops in the leads connecting the power sources will be compensated for by the regulator circuits of the individual units. For remote sensing, proceed as directed above, except connect the S+ sense terminal on the most positive supply to DC+ at the load and the S- sense terminal on the most negative supply to DC- at the load.

d. Remote Voltage Programming. The output voltage can be programmed remotely by an external fixed or variable resistance, as follows:

(1) Turn off the power source; set all output voltage controls to zero, and set the RANGE switch to 0-10V.

(2) Remove the shorting link from between the rear panel RV1 and RV2 terminals.

(3) Select a programming resistance by multiplying the desired output voltage by 1000 (the programming constant is 1000 ohms per volt). A constant current of 1 mA will flow through this resistance, and its wattage rating should be chosen to minimize drift due to heating.

(4) Connect the external programming resistance between the RV1 and RV2 terminals using twisted, shielded wire. Connect the shield to the G (chassis ground) terminal to minimize output ripple.

#### CAUTION

IF THE REMOTE PROGRAMMING CONNECTIONS ARE OPENED WHILE THE SUPPLY IS OPERATING, THE OUTPUT VOLTAGE WILL RISE ABOVE THE SET VALUE. WHEN A SWITCH IS USED TO SELECT EXTERNAL RESISTORS FOR OUTPUT VOLTAGE PROGRAMMING, IT SHOULD HAVE SHORTING TYPE CONTACTS TO AVOID VOLTAGE OVERSHOOT BETWEEN STEPS.

e. Current Limiting. The maximum output may be limited to a value just above that of any given load by turning the current limit control counterclockwise until the "LIMIT" lamp starts to flash. Then turn the control clockwise until the lamp just stops flashing. The power supply will then limit the output current to approximately 10% above that of the load. Excessive output current above this value will be indicated by the flashing LIMIT indicator.

## SECTION 3 PRINCIPLES OF OPERATION

### 3-1. GENERAL

The Model 2020 is a precision, high stability, regulated DC voltage source. It comprises a transformer, full wave rectifier and filter circuit, a series regulator circuit, a control amplifier circuit, and a current limiting circuit.

The series regulator is basically an electronically variable resistance (Q2) interposed between the unregulated DC output from the rectifier and filter circuit and the output load. The resistance (or voltage drop) is controlled by an amplifier which compares a fraction of the output voltage by means of a resistive divider with a stable zener voltage reference. The amplifier controls the effective series resistance to reduce the voltage error between the divider and the reference to zero. Thus, the regulator system will always operate to provide an output voltage proportional to the zener diode voltage by the ratio of the divider resistances. Varying this divider ratio will automatically vary the output voltage of the regulator.

### 3-2. FULL WAVE RECTIFIER AND FILTER CIRCUIT

The full wave rectifier circuit consists of diodes CR1 and CR2. Its output is filtered by C1 and applied through regulator circuit protective fuse F2 to transistor Q1 (HEATTRAN<sup>®</sup> circuit).

### 3-3. SERIES REGULATOR CIRCUIT

Q2, a silicon power transistor, is the electronically variable series resistance. A proprietary patented circuit trade marked "HEATTRAN"<sup>®</sup> operates to minimize the power dissipation in Q2 when the voltage drop across Q2 is high. When the difference between the unregulated voltage and the regulated output voltage is low, transistor Q1 is in or near saturation. As this difference voltage rises, Q1 will come out of saturation, diverting part of the load current through resistors R2 and R3 located in a cage at the rear of the unit. As this difference voltage increases, Q1 will eventually cut off and all the load current will flow in R2 and R3. Proper proportioning of the circuit constants will result in the dissipation of up to 90% of the total power normally carried by Q2 in the power resistors R2 and R3.

### 3-4. CONTROL AMPLIFIER CIRCUIT

The control amplifier circuit consists of a balanced input differential amplifier Q12, amplifier stages Q5, Q6, Q8, Q9 in cascade, and series regulator driver Q3. The zener voltage reference CR19, the constant current source for the zener (Q10 and Q11) and the input differential amplifier are held at a constant ambient temperature in a temperature stabilized oven.

The output voltage comparison divider is made up of four decade switches and precision low temperature coefficient resistors and potentiometers to provide accurate control of the supply output. Solid silver alloy contacts are employed on the switch assemblies to minimize calibration changes and noise due to wear.



SECTION 4  
MAINTENANCE

## 4-1. GENERAL

Under normal conditions, no special maintenance of the Model 2020 is required. If servicing is necessary, read the information in this section thoroughly before starting repair or calibration.

## 4-2. ADJUSTMENT AND CALIBRATION

Make the following adjustments whenever a component is replaced or periodic recalibration is scheduled:

a. Preliminary Meter Adjustment:

- (1) Mechanically zero the meter using the adjustment screw on the front panel.

NOTE: Before completing any meter adjustment, lightly tap the meter face. This will overcome any pivot friction and insure proper calibration.

- (2) Set the CURRENT LIMIT ADJ control fully clockwise.

- (3) Connect a 10 ohm, 50 watt resistor in series with a standard ammeter, across the output of the supply.

- (4) Set the AC switch to ON and adjust the output voltage controls for a convenient reading, approximately 2 amperes on a standard ammeter.

- (5) Set the meter switch to amperes.

- (6) Adjust potentiometer R18 (see Component Location Diagrams) until the panel meter reading agrees with that of the standard ammeter.

b. Zero Voltage Calibration

- (1) Connect a precision voltmeter (.01% accuracy) across the output of the supply.

- (2) Set the RANGE switch to the 0-10V position and the output voltage controls for 0.000 volt output.

- (3) Set the AC switch to ON and observe the precision voltmeter.

- (4) If the voltmeter does not indicate 0.000 volt  $\pm 1$  mV, adjust CALIBRATE potentiometer R79 (accessible through a square cutout on right side of power supply case).

c. 20-Volt Adjustment

NOTE: Make this adjustment only after zero voltage calibration.

- (1) Set the RANGE switch to 10-20V and adjust the supply output to 20.000 volts. Make sure that the vernier control is fully counterclockwise.

(2) Check that the dots on the VERNIER control and front panel are aligned. A setscrew in the VERNIER control permits any necessary adjustment.

(3) Set the VERNIER control to 0.

(4) Connect the precision voltmeter across the output of the supply.

(5) Set the AC switch to ON and observe the voltmeter.

(6) If necessary, adjust potentiometer R80 (accessible through square cutout on right side of case) until the voltmeter reads  $20.000 \pm 0.007$  volts.

d. CURRENT LIMIT ADJ Range Adjustment:

(1) Set the power supply output voltage to 20.000 volts.

(2) Place a standard ammeter across the output terminals.

(3) Set CURRENT LIMIT ADJ potentiometer R21 fully clockwise.

(4) Set the AC switch to ON and observe the ammeter.

(5) Adjust potentiometer R25 (on the amplifier board) until the ammeter reads 2.2 amperes.

(6) Turn the CURRENT LIMIT ADJ potentiometer R21 counterclockwise until the ammeter reads 1 ampere.

(7) Check that the dot on the CURRENT LIMIT ADJ knob lines up with the 1 ampere calibration marker on the front panel. A setscrew is located in the control knob for any necessary adjustment.

#### 4-3. TROUBLE SYMPTOMS AND SUGGESTED REMEDIES

a. Circuit faults can be isolated most rapidly by measuring circuit voltages and resistances. Use the data given on the schematic diagram in the Appendix as a first step in servicing the supply.

#### CAUTION

WHEN UNSOLDERING SEMICONDUCTORS FOR TEST, USE A HEAT SINK TO PREVENT THERMAL DAMAGE. A LONG NOSE PLIERS BETWEEN THE SEMICONDUCTOR AND THE SOLDER JUNCTION IS ADEQUATE. NEVER OPERATE THE POWER SUPPLY WITH ANY LEADS DISCONNECTED OR SEMICONDUCTORS REMOVED. OPERATING POTENTIALS IN THE DC AMPLIFIER MAY CHANGE RADICALLY WHEN A COMPONENT IS REMOVED OR DISCONNECTED.

b. Power Supply Does Not Go On: If the OVEN and AC lamps do not light, check the AC fuse. If the fuse blows repeatedly, check the oven circuit and diodes CR1 through CR4 and CR5 through CR8. Use an ohmmeter to take a resistance reading across each diode. Then, reverse the meter leads and take another reading. If one reading is not at least five times greater than the other, the diode is defective. If one diode in any pair is defective, replace both. A short circuit in one will produce high surge currents in the other, which can result in junction damage.

c. No DC Output Voltage: If both the AC and OVEN lamps light, but no output voltage is available, be sure that the CURRENT LIMIT ADJ control is turned fully clockwise. Set the meter switch to amperes and increase the output voltage. If no current is indicated, check the DC fuse F2 and input capacitor C1. If current is present when the output voltage controls are adjusted, check reverse current safety diode CR22, or for incorrect programming or sensing connections. Diode CR22 is connected in the opposite polarity to the DC output voltage. If the reverse current flow is greater than 3 amperes, this diode may weld, placing a permanent short circuit across the supply output. Normal operation can be restored by replacing the diode (located on the amplifier board).

d. Regulator Failure: Check for correct potentials on amplifier transistors, voltage reference, etc. If any voltage appears incorrect, disconnect AC power and make a rapid check for defective transistors. This can be done without removing the transistors from the circuit. Use an ohmmeter set to its low resistance scale (R x 1) and measure the forward and reverse resistances at the collector-base and base-emitter junctions. A resistance ratio of less than 5 to 1 indicates that the transistor is defective. Carefully remove it and check it on a transistor checker or curve tracer.

#### CAUTION

THIS TEST IS NOT RECOMMENDED FOR HIGH FREQUENCY OR LOW CURRENT DEVICES IN OTHER INSTRUMENTATION, AS CURRENTS FROM SOME OHMMETERS MAY BE SUFFICIENT TO DAMAGE SMALL SEMICONDUCTOR JUNCTIONS.

To test a component located in the oven:

- (1) Unplug the line cord and remove the carrying case.
- (2) Loosen the three screws which secure the oven cover.
- (3) Rotate the cover counterclockwise and pull it away from the oven.
- (4) Remove the two screws which secure the oven cap; then remove the cap.
- (5) Reach into the oven and extract the oven board.

NOTE: To test the oven board while the unit is operating, remove it from its socket and insert a test adapter (Vector Electronic Corp. Type P-9-N-S, or equal) in its place. The board can then be plugged into the adapter.

- (6) To reassemble the oven, replace the board, fiberglass turbulence retarding pads and cap. Secure the cap in position with the two screws. Slide the oven cover down until the screws slide into the slots in the cover. Turn the cover clockwise and tighten the three screws.

e. Poor Regulation, High Ripple: No specific check can be suggested since failure to regulate within specifications may be caused by any of the components in the supply. Make a point-to-point voltage and resistance check. Check all capacitors for open circuits and all electrolytic capacitors for excessive leakage. Make stage gain measurements by changing the output load current and noting the change in base current of each amplifier stage. Use low resistance milliammeters and microammeters. The open-loop current gain of the regulator should be more than  $10^6$  from the base current of the input differential amplifier to the collector current of the series regulator.

## APPENDIX

### 1. INTRODUCTION

This appendix contains an electrical parts list, schematic diagram, parts location diagram and equipment warranty.

### 2. ELECTRICAL PARTS LIST

All electrical and electronic parts are listed in the sequence of their circuit numbers as shown on the schematic diagram. A brief description of each part is given, followed by the code number of the manufacturer and his part number. All manufacturers' code numbers are taken from Cataloging Handbooks H4-1 and H4-2, Federal Supply Code for Manufacturers. These handbooks are available through Federal Agencies. They may also be ordered directly from the Superintendent of Documents, U. S. Government Printing Office, Washington, D. C. 20402.

We recommend that all parts having the code number 98095 be ordered directly from Power Designs Inc. The commercial equivalents of these parts have either wide parameter tolerances or require special factory inspection or modification before they are suitable for use in the power supply.

All components used in the power supply or supplied as replacements are carefully inspected at the factory. Inspections are performed on a 100% basis or at AQL levels in accordance with Military Specification MIL-Q-9858 under which Power Designs Inc. has been qualified.

All semiconductors are inspected on a 100% basis. They are inspected not only for operating parameters, but also for critical characteristics related to reliability and predictable life expectancy. Some of these characteristics are observed when the device is taken beyond its normal operating regions. These test techniques have been developed under a "predictable-reliability" program in operation at Power Designs Inc. for the past ten years. Under this program, quality-control procedures are constantly reevaluated and updated as new advances are made in solid-state technology and additional experience is gleaned from field history.

Semiconductor manufacturers are constantly modifying their products. Complete lines are frequently discontinued to be replaced by devices having improved gain, operating voltage levels and frequency response. The high-gain, closed-loop DC amplifiers used in regulator circuits are particularly sensitive to slight changes in these parameters. Commercial or military "equivalent" transistors used as replacements may affect the power supply performance. Compliance with the original specifications can be assured if replacement semiconductors are ordered from the factory.

All replacement semiconductors are processed and stocked at the factory to insure complete interchangeability with the devices in the original equipment. To insure that proper replacements are provided, the original devices are coded with a Power Designs Inc. part number as follows:

<u>MS</u>	<u>696</u>	<u>A</u>
Semiconductor Manufacturer's Code	Power Designs Inc. Type	Suffix Identifying Special Parameters

When ordering replacements, please identify the device as completely as possible, listing the model and serial number if available.

In some cases the replacement part received may have a different part number from that given in the Electrical Parts List. This can be due to several factors:

a. A different prefix indicates that Power Designs Inc. is using a different vendor source. The operating characteristics of the devices are identical.

b. A completely different part number indicates:

1. The original vendor discontinued manufacture of the item or could no longer manufacture it to the original specifications.
2. A better device for use in the particular circuit has been substituted.
3. Tighter controls for interchangeability have provided greater assurance of improved reliability with the new replacement.



## ELECTRICAL PARTS LIST

NOTE: When replacing semiconductors or investigating their part numbers, note the information in paragraph 2.

<u>Circuit Number</u>	<u>Description</u>	<u>Mfr Code Number</u>	<u>Part Number</u>
A1	Oven board assembly	98095	PS-2020-4
C1	Capacitor, electrolytic, 4700 uf, 50 vdc	98095	CE-472-50
C2	Capacitor, tantalum, 4.7 uf, 35 vdc	98095	CE-34-.35
C3	Capacitor, plastic film, 0.22 uf, 80 vdc	98095	CP-29-.8
C4	Capacitor, electrolytic, 140 uf, 25 vdc	98095	CEX-140-25
C5	Capacitor, electrolytic, 1 uf, 100 vdc	98095	CE-59-1
C6, C7	Capacitor, electrolytic, 100 uf, 80 vdc	98095	CE-91-.8
C8	Capacitor, plastic film, 0.0047 uf, 200 vdc	98095	CP-26-2
C9	Capacitor, plastic film, 0.022 uf, 200 vdc	98095	CP-A022-2
C10	Capacitor, plastic film, 0.1 uf, 1 kvdc	98095	CP-17-2
C11	Capacitor, tantalytic, 1 uf, 50 vdc	98095	CE-1-500
C12	Capacitor, ceramic disc, 0.0022 uf, 1 kvdc	98095	CC-19-10
C13	Capacitor, ceramic disc, 0.01 uf, 1 kvdc	98095	CC-13-10
C14	Capacitor, ceramic disc, 0.05 uf, 600 vdc	98095	CC-34-6
C15	Capacitor, plastic film, 680 pf, 200 vdc	98095	CP-27-2
C16	Capacitor, plastic film, 6 uf, 100 vdc	98095	CP-6-101
C17	Capacitor, electrolytic, 140 uf, 25 vdc	98095	CEX-140-25
C18, C19	Capacitor, ceramic disc, 1 uf, 3 vdc	98095	CC100M3AD
C20, C21	Capacitor, electrolytic, 140 uf, 25 vdc	98095	CEX-14-25
C22, C23	Capacitor, plastic film, 0.1 uf, 200 vdc	98095	CP-17-2
C24	Capacitor, electrolytic, 1 uf, 100 vdc	98095	CE-59-1
CR1, CR2	Diode, silicon	98095	SS66
CR3 thru CR9	Diode, silicon	98095	GI44
CR10	Diode, silicon	98095	AC359Z
CR11, CR12	Diode, silicon	98095	GI587
CR13	Diode, silicon	98095	GI44
CR14	Diode, silicon	98095	D20
CR15	Diode, silicon, zener	98095	AC359D
CR16, CR17	Diode, silicon	98095	GI44
CR18, CR19	Diode, silicon, zener	98095	1N823H
CR20, CR21	Diode, silicon	98095	GI44
CR22	Diode, silicon	98095	SS66
CR23, CR24	Diode, silicon	98095	GI44
DS1	Indicator lamp, neon	98095	PLA-13
DS2	Indicator lamp, neon	98095	PLA-14
DS3 thru DS5	Indicator lamp, neon	98095	PLA-13
F1	Fuse, 1.5 A, "Slo-Blo"	71400	Type MDX
F2	Fuse, 4 A, "Slo-Blo"	71400	Type MDX
XF1	Fuseholder	75915	342022
M1	Meter, dual, voltammeter, 0-20 V, 0-2 A	98095	MVA-125
Q1, Q2	Transistor, silicon, NPN	98095	MS1700
Q3 thru Q5	Transistor, silicon, NPN	98095	MS2270/U
Q6	Transistor, silicon, NPN	98095	MS1028A
Q7	Transistor, silicon, NPN	98095	2N4888
Q8, Q9	Transistor, silicon, NPN	98095	MS2916

<u>Circuit Number</u>	<u>Description</u>	<u>Mfr Code Number</u>	<u>Part Number</u>
Q10	Transistor, silicon, PNP	98095	MS1028A
Q11	Transistor, dual, NPN	98095	MS2270/U
Q12	Transistor, dual, NPN	98095	MS2916
R1	Resistor, composition, 100 k ohms, 10%, $\frac{1}{2}$ w	01121	EB1041
R2, R3	Resistor, wirewound, 7.5 ohms, 5%, 40 w	98095	RW-7F5-3J
R4	Resistor, wirewound, 200 ohms, 5%, 3 w	98095	RW-201-3K
R5	Resistor, composition, 150 ohms, 10%, 2 w	01121	HB1511
R6	Resistor, composition, 47 k ohms, 10%, $\frac{1}{2}$ w	01121	EB4731
R7	Resistor, wirewound, 800 ohms, 5%, 5 w	98095	RW-801-3RA
R8	Resistor, composition, 470 k ohms, 10%, $\frac{1}{2}$ w	01121	EB 4741
R9	Resistor, wirewound, 600 ohms, 5%, 5 w	98095	RW-601-3RA
R10	Resistor, precision, metal film, 49.9 k ohms, 1%, $\frac{1}{4}$ w	98095	RD-4992-1QA
R11	Resistor, precision, metal film, 6.81 k ohms, 1%, $\frac{1}{4}$ w	98095	RD-6811-1QA
R12	Resistor, precision, metal film, 1.5 k ohms, 1%, $\frac{1}{4}$ w	98095	RD-152-1QA
R13	Resistor, precision, metal film, 10 k ohms, 1%, $\frac{1}{4}$ w	98095	RW-103-1QA
R14	Resistor, precision, metal film, 562 ohms, 1%, $\frac{1}{4}$ w	98095	RD-5620-1QA
R15	Resistor, precision, metal film, 511 ohm, 1%, $\frac{1}{4}$ w	98095	RD-5110-1QA
R16	Resistor, precision, metal film, 10 k ohms, 1%, $\frac{1}{4}$ w	98095	RW-103-1QA
R17	Resistor, composition, 2.2 k ohms, 10%, $\frac{1}{2}$ w	01121	EB2221
R18	Resistor, wirewound, variable, 500 ohms, 10%, $1\frac{1}{4}$ w	98095	RWT-501-C4
R19	Resistor, precision, metal film, 665 ohms, 1%, $\frac{1}{4}$ w	98095	RD-6650-1QA
R20	Resistor, wirewound, 0.5 ohm, 5%, 5 w	98095	RW-005-3RA
R21	Potentiometer, 200 ohms, 10%, 2 w	98095	RWV201C4-.87
R22	Resistor, precision, metal film, 3.0 k ohms, 1%, $\frac{1}{4}$ w	98095	RD-302-1QA
R23	Resistor, precision, metal film, 2.55 k ohms, 1%, $\frac{1}{4}$ w	98095	RD-2551-1QA
R24	Resistor, precision, metal film, 20 k ohms, 0.5%, $\frac{1}{4}$ w	98095	RD-203-6QA
R25	Resistor, wirewound, variable, 1 k ohm, 10%, $1\frac{1}{4}$ w	98095	RWT102C4
R26	Resistor, composition, 1 k ohm, 5%, $\frac{1}{2}$ w	01121	EB1025
R27	Resistor, precision, metal film, 16.2 k ohms, 1%, $\frac{1}{4}$ w	98095	RD-1622-1QA
R28	Resistor, precision, metal film, 10 k ohms, 1%, $\frac{1}{4}$ w	98095	RW-103-1QA
R29	Resistor, precision, metal film, 3 k ohms, 1%, $\frac{1}{4}$ w	98095	RD-302-1QA
R30	Resistor, precision, metal film, 604 ohms, 1%, $\frac{1}{4}$ w	98095	RD-6040-1QA
R31, R32	Resistor, precision, metal film, 4.32 k ohms, 1%, $\frac{1}{4}$ w	98095	RD-4321-1QA
R33	Resistor, precision, metal film, 1 k ohm, 1%, $\frac{1}{4}$ w	98095	RD-102-1QA
R34	Resistor, precision, metal film, 100 ohms, 1%, $\frac{1}{4}$ w	98095	RD-101-1QA
R35	Resistor, precision, metal film, 649 ohms, 1%, $\frac{1}{4}$ w	98095	RD-6490-1QA
R36	Resistor, precision, metal film, 24.9 k ohms, 1%, $\frac{1}{4}$ w	98095	RD-2492-1QA
R37	Resistor, precision, metal film, 665 ohms, 1%, $\frac{1}{4}$ w	98095	RD-6650-1QA
R38	Resistor, precision, metal film, 150 k ohms, 1%, $\frac{1}{4}$ w	98095	RD-154-1QA
R39	Resistor, precision, metal film, 45.3 k ohms, 1%, $\frac{1}{4}$ w	98095	RD-4532-1QA
R40	Resistor, precision, metal film, 49.9 k ohms, 1%, $\frac{1}{4}$ w	98095	RD-4992-1QA
R41	Resistor, precision, metal film, 1 k ohm, 1%, $\frac{1}{4}$ w	98095	RD-102-1QA
R42	Resistor, precision, metal film, 10 k ohms, 1%, $\frac{1}{4}$ w	98095	RD-103-1QA
R43	Resistor, precision, metal film, 125 ohms, 1%, $\frac{1}{4}$ w	98095	RD-1250-1QA
R44	Resistor, precision, metal film, 715 ohms, 1%, $\frac{1}{4}$ w	98095	RD-7150-1QA
R45	Resistor, precision, wirewound, 10 k ohms, 0.1%, 0.4 w	98095	RW-103-8UR
R46	Potentiometer, 1 ohm, 10%, 2 w	98095	RWV010C4-.81
R47	Resistor, precision, metal film, 1 k ohm, 0.1%, 0.4 w	98095	RW-102-8UR
R48, R49	Resistor, precision, metal film, 2 k ohms, 0.1%, 0.4 w	98095	RW-202-8UR
R50	Resistor, precision, metal film, 5 k ohms, 0.1%, 0.4 w	98095	RW-502-8UR
R51	Resistor, composition, 4.7 k ohms, 10%, $\frac{1}{4}$ w	01121	CB4721
R52	Resistor, composition, 6.8 k ohms, 10%, $\frac{1}{4}$ w	01121	CB6821
R53	Resistor, composition, 18 k ohms, 10%, $\frac{1}{4}$ w	01121	CB1831
R54	Resistor, composition, 27 k ohms, 10%, $\frac{1}{4}$ w	01121	CB2731
R55	Resistor, precision, wirewound, 100 ohms, 0.1%, 0.4 w	98095	RW-101-8UR

<u>Circuit Number</u>	<u>Description</u>	<u>Mfr Code Number</u>	<u>Part Number</u>
R56,R57	Resistor, precision, wirewound, 200 ohms, 0.1%, 0.4w	98095	RW-201-8UR
R58	Resistor, precision, wirewound, 500 ohms, 0.1%, 0.4 w	98095	RW-501-8UR
R59	Resistor, composition, 470 ohms, 10%, $\frac{1}{4}$ w	01121	CB4711
R60	Resistor, composition, 680 ohms, 10%, $\frac{1}{4}$ w	01121	CB6811
R61	Resistor, composition, 1.8 k ohms, 10%, $\frac{1}{4}$ w	01121	CB1821
R62	Resistor, composition, 2.7 k ohms, 10%, $\frac{1}{4}$ w	01121	CB2721
R63	Resistor, precision, wirewound, 10 ohms, 1%, 0.4 w	98095	RW-100-1UR
R64, R65	Resistor, precision, wirewound, 20 ohms, 0.5%, 0.4 w	98095	RW-200-6UR
R66	Resistor, precision, wirewound, 50 ohms, 0.5%, 0.4 w	98095	RW-500-6UR
R67	Resistor, composition, 47 ohms, 10%, $\frac{1}{4}$ w	01121	CB4701
R68	Resistor, composition, 68 ohms, 10%, $\frac{1}{4}$ w	01121	CB6801
R69	Resistor, composition, 180 ohms, 10%, $\frac{1}{4}$ w	01121	CB1811
R70	Resistor, composition, 270 ohms, 10%, $\frac{1}{4}$ w	01121	CB2711
R71	Resistor, precision, wirewound, 1 ohm, 3%, 0.4 w	98095	RW-010-7UR
R72, R73	Resistor, precision, wirewound, 2 ohms, 3%, 0.4 w	98095	RW-020-7UR
R74	Resistor, precision, wirewound, 5 ohms, 3%, 0.4 w	98095	RW-050-7UR
R75	Resistor, composition, 4.7 ohms, 10%, $\frac{1}{4}$ w	01121	CB47G1
R76	Resistor, composition, 6.8 ohms, 10%, $\frac{1}{4}$ w	01121	CB68G1
R77	Resistor, composition, 18 ohms, 10%, $\frac{1}{4}$ w	01121	CB1801
R78	Resistor, composition, 27 ohms, 10%, $\frac{1}{4}$ w	01121	CB2701
R79	Potentiometer, 10 k ohms, 5%, $\frac{3}{4}$ w	98095	RWV-103-3X
R80	Potentiometer, 500 ohms, 5%, $\frac{3}{4}$ w	98095	RWV-501-3X
R81	Resistor, composition, 100 k ohms, 10%, $\frac{1}{2}$ w	01121	EB1041
R82	Resistor, composition, 10 ohms, 10%, $\frac{1}{2}$ w	01121	EB1001
R83	Resistor, precision, wirewound, 6.05 k ohms, 0.1%, $\frac{1}{2}$ w	98095	RW-6051-8Q
S1	Switch, toggle, SPST	98095	ST-5
S2, S3	Switch, toggle, DPDT	98095	ST-16
S4	Switch, rotary	98095	PS-2005-7-3
S5	Switch, rotary	98095	PS-2005-7-4
T1	Transformer	98095	TTM-2020-1(*)
Z1	Oven assembly	98095	PS-2020-5

## CODE LIST OF MANUFACTURERS

Code Number	Manufacturer	Address
01121	Allen-Bradley Company	Milwaukee, Wisconsin
71400	Bussman Manufacturing Division	St. Louis, Missouri
75915	Littelfuse, Inc.	Des Plaines, Illinois
98095	Power Designs Inc.	Westbury, New York

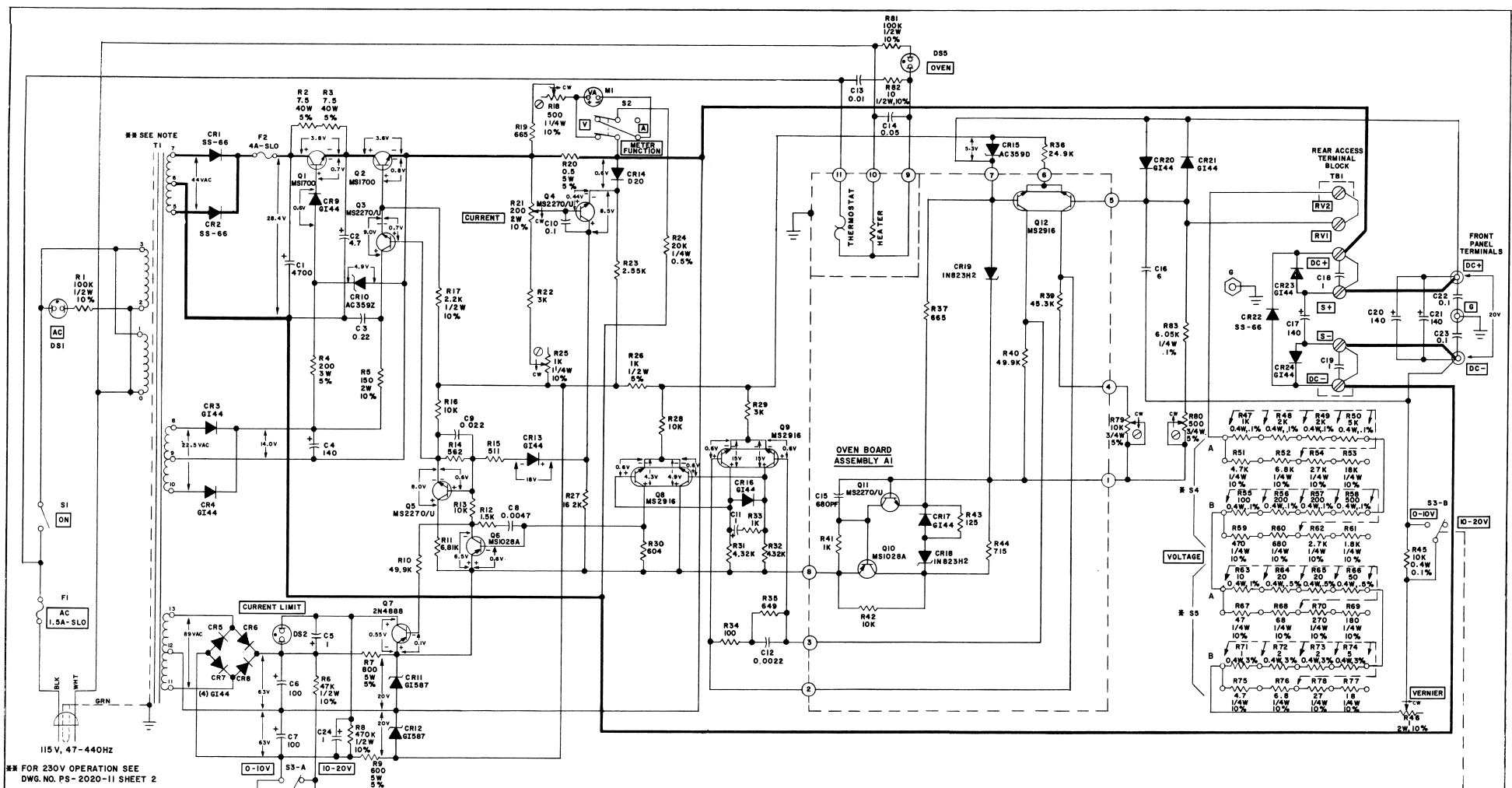

115 V, 47-440HZ  
 \*\* FOR 230V OPERATION SEE  
 DWG. NO. PS-2020-11 SHEET 2

NOTES: 1. UNLESS OTHERWISE SPECIFIED  
 ALL RESISTORS ARE IN OHMS, 1/4W, 1%  
 ALL CAPACITORS ARE IN MICROFARADS

2. VOLTAGES INDICATED ARE MEASURED WITH 115VAC, 60HZ INPUT AND  
 WITH OUTPUT VOLTAGES AS SHOWN. MEASUREMENTS MADE AT FULL LOAD  
 WITH 20,000Ω/VOLT METER FOR DC AND 1000Ω/VOLT METER FOR AC.  
 VOLTAGES ARE DC UNLESS OTHERWISE INDICATED.

3. S4A: BCD SWITCH  
 1000Ω PER STEP

S4B: BCD SWITCH  
 100Ω PER STEP

S5A: BCD SWITCH  
 10Ω PER STEP

S5B: BCD SWITCH  
 1Ω PER STEP

RELEASED	DATE	BY
DRAWING NO. PS-2020-11	REV. 1/005	
TITLE: SCHEMATIC, PRECISION DC SOURCE		
0-20V, 0-2A MODEL 2020		
DRAWN BY	CHECKED BY	APPROVED BY
DATE 6-16-60	DATE 7-19-60	DATE 7/2/60
PERRY ELECTRONIC INC.		
NEW YORK		

- FOR 230V OPERATION:
- ON UNDERSIDE OF AMPLIFIER BOARD LIFT JUMPER SHOWN IN POSITION FOR 115V OPERATION. RECONNECT TO POSITION SHOWN FOR 230V OPERATION.
  - ON TRANSFORMER T1, REMOVE JUMPERS FROM TERMINALS 0 TO 2 AND 1 TO 3. ADD JUMPER FROM TERMINALS 1 TO 2.

230V JUMPER  
115V JUMPER

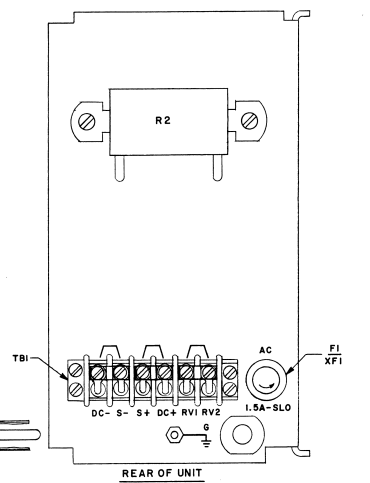
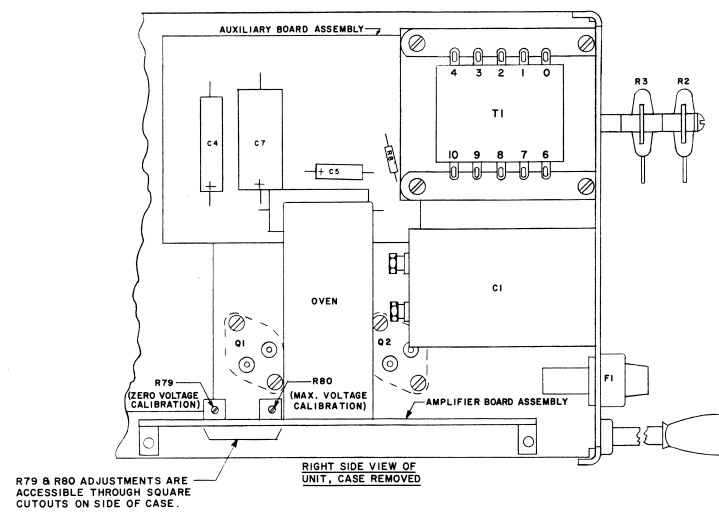
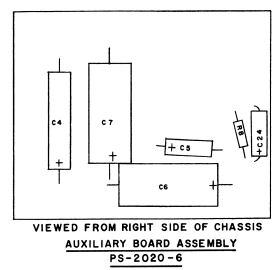
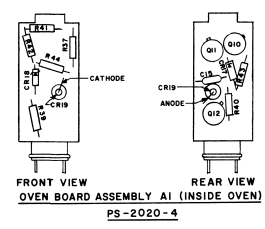
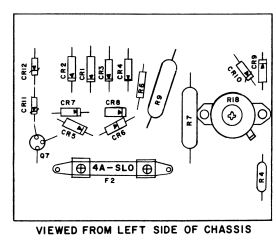
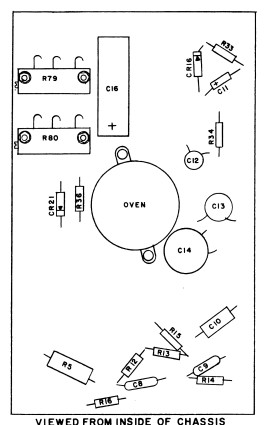
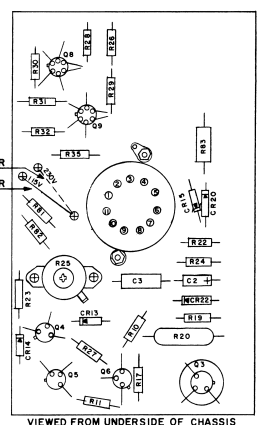
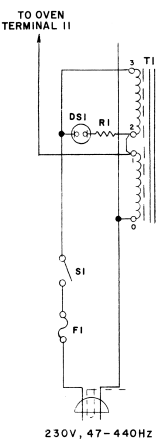

R79 & R80 ADJUSTMENTS ARE ACCESSIBLE THROUGH SQUARE CUTOUTS ON SIDE OF CASE.

A RELEASED	
DRAWING NO. PS-2020-11	
TITLE: LOCATION OF COMPONENTS	
MOD. 2020 PRECISION DC SOURCE	
DATE: 11/22/67	DATE: 7/17/68
Power Design, Inc.	
NEW YORK	



## **W A R R A N T Y**

**POWER DESIGNS INC., warrants to the original purchaser, each instrument sold by us, or our authorized agents, and all the parts thereof, to be free from defects in material or workmanship under normal use and service within the specified ratings and operating conditions.**

**Its obligation under this warranty is hereby limited to the repair or replacement of any instrument, or part thereof, which is returned to us within one year after delivery, and which shall prove, after our examination, to be thus defective.**

**This warranty does not include the cost of transportation charges to and from the factory and/or the cost of packaging or crating of instruments for return to the factory, unless such instrument is returned within thirty (30) days from the date of original shipment as shown on the packing list or shipping documents, and prior written authorization for such costs is obtained from the factory.**

**The repair or replacement of an instrument, or any part thereof, does not void or extend the original warranty.**

**POWER DESIGNS INC., reserves the right to discontinue any instrument without notice, or to make modifications in design at any time, without incurring any obligation to make these modifications in instruments previously sold.**

**POWER DESIGNS INC.**

Westbury, L. I., New York

**POWER DESIGNS PACIFIC, INC.**

Palo Alto, California

## SALES OFFICES

### ARKANSAS, LOUISIANA, OKLAHOMA & TEXAS

APPLIED SCIENCE ASSOCIATES 3707 Rawlins St., Dallas, Texas 75219 (214) 526-8316  
6218 Westheimer, Suite B., Houston, Texas 77027 (713) 781-1441  
7966 East 41 Street, Tulsa, Oklahoma 74145 (918) 627-6199

### CALIFORNIA; RENO, NEVADA

DYNAMIC ASSOCIATES 1011-E Cadillac Way, (San Francisco) Burlingame, Calif. 94010 (415) 344-2521  
5190 West Washington Blvd., Los Angeles, Calif. 90016 (213) 933-5833

### INDIANA, ILLINOIS, WISCONSIN, MISSOURI, IOWA, MINNESOTA, N. & S. DAKOTA

LOREN F. GREEN & ASSOCIATES 5218 West Diversey Ave., Chicago, Ill. 60639 (312) 286-6824  
6225 University Ave., N.E. Minneapolis, Minn. 55421 (612) 781-1611

### ALABAMA, GEORGIA, FLORIDA, NORTH CAROLINA, SOUTH CAROLINA, TENNESSEE, MISSISSIPPI

E. G. HOLMES & ASSOC. 3667 Clairmont Road, Chamblee, Ga. 30005 (404) 451-6161  
4862 Governors Drive W., Huntsville, Ala. 35805 (205) 837-6900  
316½ South Bumby, Orlando, Fla. 32803 (305) 241-2128  
430 W. Friendly Street, Greensboro, N. C. 27401 (919) 272-0855

### ARIZONA, NEW MEXICO, UTAH, COLORADO, WYOMING, NEVADA (LAS VEGAS)

HYTRONIC MEASUREMENTS INC. 4940 E. 39 Avenue, Denver, Colorado 80207 (303) 388-4081  
1017 North 3rd Street, Suite 9, Phoenix, Arizona 85004 (602) 253-6104  
2022 South Main Street, Salt Lake City, Utah 84115 (801) 466-4924  
205 San Pablo South East, Albuquerque, New Mexico 87108 (505) 268-3941

### NEW YORK (S.), CONNECTICUT (FAIRFIELD COUNTY)

QED ELECTRONICS 500 Nuber Avenue, Mount Vernon, N.Y. 10550 (914) 968-2200

### NEW JERSEY, PENNSYLVANIA (E.)

QED ELECTRONICS 2916 Federal Street, Camden, New Jersey 08105 (215) 925-8711

### MARYLAND, DELAWARE, WASHINGTON, D.C., VIRGINIA

QED ELECTRONICS 880 Bonifant Street, Silver Springs, Md. 20910 (301) 588-8134

### NEW YORK (N.)

OSSMANN INSTRUMENTS, INC. 101 Pickard Drive, Syracuse, New York 13211 (315) 454-2461  
3100 Monroe Avenue, Rochester, New York 14618 (716) 586-0380  
Vestal Parkway East, Vestal, New York 13850 (607) 785-9947  
P.O. Box 207, Wappingers Falls, New York 12590 (914) 297-7777

### NEW ENGLAND

HOWARD J. SCHUFT CO., INC. 815 Washington Street, Newtonville, Mass. 02160 (617) 527-5304 & 5

### CONNECTICUT

HOWARD J. SCHUFT CO., INC. 965 Dixwell Avenue, New Haven, Connecticut 06514 (203) UN 5-1365

### WASHINGTON, OREGON, IDAHO, MONTANA, ALASKA, BRITISH COLUMBIA

SHOWALTER-JUDD INC. 1806 S. Bush Place, Seattle, Washington 98144 (206) 324-7911

### OHIO, PENNSYLVANIA (W.), MICHIGAN, INDIANA, KENTUCKY

HARVEY TEPLITZ & CO. 3718 Salem Avenue, Dayton, Ohio 45406 (513) 277-9178  
26847 Grand River Ave., Detroit, Michigan 48240 (313) 537-9058  
3945 Meadowbrook Blvd., Cleveland, Ohio 44118 (216) 371-2044

### CANADA

R-O-R ASSOCIATES, LTD. 1470 Don Mills Road, Don Mills, Ontario (416) 444-4403  
3825 Cavendish Blvd., Montreal 28, Quebec (514) 482-8430  
1320 Carling Ave., Ottawa 3, Ontario (613) 722-6531  
805 5th Street S.W., Calgary, Alberta (403) 265-6470

### FOREIGN

ROCKE INTERNATIONAL CORP. 13 East 40 Street, New York, New York 10016 (212) MU 9-0200



**POWER DESIGNS, INC.**

1700 SHAMES DRIVE • WESTBURY, N.Y.  
516 EDgewood 3-6200 TWX: 510-222-6561

**POWER DESIGNS PACIFIC, INC.**

3381 JUNIPERO SERRA • PALO ALTO, CALIFORNIA  
415-321-6111 TWX: 910-373-1261