

INSTRUCTION MANUAL MODELS 2020B, 5020, C500



POWER DESIGNS INC.

1700 SHAMES DRIVE • WESTBURY, N. Y. 11590 TEL (516) 333-6200
TWX (510) 222-6561
FAX (516) 333-6512

INSTRUCTION MANUAL

SECTION I INTRODUCTION

1.1 GENERAL

This manual contains instructions for the installation, operation and maintenance for the Power Designs family of Precision Calibrated Low Voltage Power Sources.

1.2 DESCRIPTION

This regulated power source is designed to provide extremely accurate and stable D.C. output with less than 100 microvolts of ripple and noise content.

Two dual concentric decade switches provide digital presentation of a selected output voltage to four places. A calibrated potentiometer permits interpolation to a fifth digit (Model 2020B) and sixth digit (Models 5020 & C500). The model 2020B includes a toggle switch for 10-20 volt operation with no change in resolution. The calibration for all models is 0.1% of the dial settings.

The output voltage of the supply may be remotely programmed with an external resistance without loss of accuracy. Rear terminals provide for remote sensing of the output voltage at the load. Calibrated output is available through either panel mounted binding posts of a rear mounted terminal strip. Metering is provided by means of a dual scale edgewise meter. A function switch selects voltage or current monitoring.

Current limiting is continuously adjustable by means of a front panel control. The "pull-to-set" switch permits adjustments of the current limit point without shorting the output terminals. A flashing panel lamp indicates an overload or short condition.

The power supply is floating with respect to the chassis permitting positive or negative polarity. The output may be continuously shorted without damage to the power source. Each power supply is "burned in" for 100 hours prior to test and shipment with calibration data. The power source is housed in a blue enamel cabinet. The front panel is brushed aluminum with black nomenclature. A tilting bail assembly is provided for ease of viewing. Panel adaptors are available for mounting one or two units in a standard 19 inch rack.

1.3 ELECTRICAL SPECIFICATIONS

INPUT: 105 to 125 Volts, 47 to 440 Hz. 210 to 240 Volt operation is available by changing internal jumpers on the power transformer.

OUTPUT:

MODEL	OUTPUT		REGULATION	RIPPLE & NOISE	STABILITY PER 8 HRS.	TC PER °C
	VOLTAGE	CURRENT				
2020B	0-20V	0-2A	.001%	100uv P-P	.001% + 100uv	.001%
5020	0-50V	0-1A	.001%	100uv P-P	.001% + 100uv	.001%
	0-20V	0-2A				
C500	0-100V	0-.5A	.001%	100uv P-P	.001% + 100uv	.001%

Regulation: DC voltage change less than 100 microvolts for line or load variations over the operating range at the rear terminals.

Ripple and Noise: Less than 100 microvolts peak-to-peak when operated at frequencies between 47 - 63 Hz (measured with an oscilloscope with a bandwidth of 10 MHz).

Source Impedance: Less than 0.002 ohm at DC; 0.04 ohm at 20 KHz; 0.5 ohm at 1 MHz (measured at the rear terminals).

Recovery Time: Less than 50 microseconds to return to within 20 millivolts of the set voltage, for a step change (1 microsecond rise time) of 80% of rated load (20% minimum load).

Stability: Better than 0.001% + 100 microvolts per 8 hours; better than 1 mv per week (at constant line, load and ambient temperature).

Temperature Coefficient: DC output voltage changes less than 0.001% of 50 microvolts (whichever is greater) per °C over the range 0°C to +45°C, less than 0.002% or 100 microvolts (whichever is greater) per °C from +45°C to +60°C.

Metering: Front-panel volt-ammeter permits monitoring output voltage or current with an accuracy of $\pm 3\%$ of full scale.

Remote Programming: Rear panel barrier strip terminals are provided for remote programming of the output voltage. The ratio of programming resistance to the output voltage is 1,000 ohms per volt. Programming accuracy is better than 0.01% of the programming resistance (including the resistance of the leads).

Calibration Accuracy: 0.1% + 0.5 mv of set value.

Current Limiting: Continuously adjustable by a front panel control. Pull-to-Set switch permits easy adjustment without shorting the output terminals. Flashing lamp indicates overload or short circuit.

Remote Sensing: Two terminals provided on a rear barrier strip for remote sensing of the voltage at the load.

Circuit Protection: The AC line and DC load circuits are separately fused.

1.4 MECHANICAL SPECIFICATIONS

DIMENSIONS: 8 3/8" x 4 3/4" x 11 5/8".

WEIGHT: 13 lbs.

FINISH: Brushed, satin aluminum panel with lithographed black lettering. Dust cover finished in blue enamel; chassis and bottom plate, golden irridite.

RACK PANEL ADAPTERS: Panel adapters are available for mounting either a single unit or two units side by side.

SECTION 2 INSTALLATION AND OPERATION

2.1 UNPACKING AND INSPECTION

This instrument is ready for operation as shipped from the factory. After unpacking inspect for damage that might have occurred in transit.

2.2 PRELIMINARY PROCEDURES

The power supply is shipped from the factory wired for 115 VAC operation unless otherwise specified at the time of order. If 220 VAC operation is required, refer to the schematic diagram in the appendix of the is manual for transformer jumper change information.

- 2.2.1 Set the AC switch to the OFF position and connect the line cord to an appropriate source of AC power.
- 2.2.2 Set the decade voltage control switches to the maximum output position.
- 2.2.3 Rotate the current control fully clockwise.
- 2.2.4 Set the AC switch to the ON position. The AC lamp should light.
- 2.2.5 Set the meter function switch to the volts position. The meter should indicate maximum volts. Rotating the voltage control switches counter-clockwise should reduce the output voltage. Set the voltage to the desired level.
- 2.2.6 Connect the load to either the front or rear output terminals.

2.3 CONSTANT VOLTAGE OPERATION

2.3.1 Voltage Adjustment

- (1) Rotate the voltage control decade switches fully counter-clockwise.
- (2) Set the AC switch to the ON position. The AC pilot light should illuminate.
- (3) Set the meter function switches to the volts position.
- (4) Set the voltage control to the desired level.

2.3.2 Current Limiting

- (1) Set the AC switch to the OFF position.
- (2) Set the AC switch to the ON position and the meter function switch to the amps position.
- (3) Pull out the CURRENT LIMIT knob and set the current to the desired level.
- (4) Push the CURRENT LIMIT knob in without changing the setting of the control.

2.3.2 Remote Current Limiting

- (1) Disconnect the shorting link between RC1 and RC2 (terminals 7 and 8).
- (2) Correct the remote programming resistance between RC1 and DC1 (terminals 8 and 1).
- (3) The programming constant is approximately 1 K ohm for 1 ampere of current.

2.3.3 Sensing

The regulator circuit maintains the potential between the sense leads (S+ and S-) at the set output voltage. When these leads are connected to the positive and negative output terminals at the rear terminal block, the power source is connected for local sensing. When the sense leads are connected to the load, the source is connected for remote sensing. Remote sensing is used when an appreciable voltage drop (up to 0.4 volt) is anticipated in the leads connecting the positive and negative output terminals to the load. The unit is connected for local sensing when shipped from the factory.

For Remote Sensing:

- (1) Remove the shorting links from the rear panel DC+ and S+, and DC- and S- terminals.
- (2) Connect the DC+ and DC- leads to the load.
- (3) Connect the S+ and S- leads to the positive and negative sides of the load, respectively. Run the sense leads as a tightly twisted, shielded pair. Connect the shield to the G (chassis ground) terminal to minimize output ripple.
- (4) Turn on the power supply.
- (5) If one of the remote sensing leads are opened while the supply is operating, the output voltage will rise slightly above the set level (approximately 0.6 volt).

2.3.4 Series Operation

As many as four units may be connected in series. Connect the positive DC output terminal of one supply to the negative output terminal of the next, in the same manner as connecting batteries in series. The ground terminals on all units may be left floating or may be tied together and connected to either the most positive or most negative output terminal.

2.3.5 Remote Voltage Programming

The output voltage can be programmed remotely by an external fixed variable resistance as follows:

Turn off the power source. Set all output voltage controls to zero. Set the switch to 0-10V on the model 2020B.

Remove the shorting link between the rear panel RV1 and RV2 terminals.

Select a programming resistance by multiplying the desired output voltage by 1000 (the programming constant is 1000 ohms per volt). A constant current of 1 milli-ampere will flow through this resistance, and the wattage rating should be chosen to minimize drift due to heating.

Connect the external programming resistance between the RV1 and RV2 terminals using twisted, shielded wire. Connect the shield to chassis ground (G terminal) to minimize output ripple. The accuracy of programming is approximately .05% + the accuracy of the programming resistance. The resistance of the remote programming wires used must be added to the resistor value to determine total resistance. Wires no smaller than #20 should be used.

Turn on the power source.

2.3.5 Remote Voltage Programming Continued

If the length of #20 wires used for remote programming is 10 feet, there will be an offset of approximately 200 microvolts. This should be noted in choosing the size of remote programming wires.

CAUTION: IF THE REMOTE PROGRAMMING CONNECTIONS ARE OPENED WHILE THE SUPPLY IS OPERATING, THE OUTPUT VOLTAGE WILL RISE TO THE UNREGULATED VOLTAGE LEVEL. WHEN A SWITCH IS USED TO SELECT RESISTORS FOR OUTPUT VOLTAGE PROGRAMMING, CHOOSE ONE WITH SHORTING TYPE CONTACTS TO AVOID VOLTAGE SPIKES.

SECTION 3 PRINCIPLES OF OPERATION

The precision power source uses a "Linear Mode" series regulator system to obtain a highly stable DC output with exceptionally low ripple and noise. This technique consists of an electronically controlled variable impedance (series regulator) between a DC unregulated source and the output terminals.

The main secondary of the power transformer (T1) in conjunction with a full wave rectifier and filter capacitors provide an unregulated D.C. power source. The series regulator transistors are connected to this source and provide the power to the output terminals. A driver transistor (Q7) supplies the drive current to the series regulators.

An additional secondary on the transformer in conjunction with CR1 thru CR4 produces an unregulated DC source. Transistor Q1 and amplifier U1A act to regulate this source and to supply a stable bias voltage to operate the internal amplifier and comparator circuits.

The basic voltage control is accomplished by U2 and its associated circuitry. The output of U2 drives the base of Q3 which in turn furnishes drive current to Q7. The offset adjust pot R42 sets the output to zero when the voltage controls are at zero. The current through R34 which is connected to the reference (U3), plus the current through R35 is equal to the current through the resistor selected by the output decade switches and vernier adjustment control. The feedback action of the loop operates to maintain the summing junction as close to zero as possible. Capacitor C20 provides AC feedback from the supply output to the input of U2, reducing the output ripple and noise.

Current limit action is provided by U1B and its associated circuitry. Whenever the load current is less than that selected by the current control, the input to pin 5 of U1B is greater than pin 6. If the load current increases past the point set by the current control, pin 5 becomes equal to pin 6 and CR5 becomes forward biased. When this occurs the current amplifier controls the loop and provides current limiting action. The "pull-to-set" switch (S4), when engaged, places a small value resistor across the output terminals to simulate an overload condition. This provides a convenient way to set the current-limit threshold point.

SECTION 4 MAINTENANCE

4.1 GENERAL

This section covers maintenance and calibration procedures. Under normal conditions, no special maintenance is required. If trouble does develop however, the easily removable wrap-around cover and bottom plate and the location of the printed circuit board provide exceptional accessibility to all components of the supply.

Regulation and ripple measurements of the output in both voltage and current mode are an excellent indication of the power supply's performance. Special techniques must be employed to properly measure these parameters to avoid measuring voltage drops due to load currents. Details of correct measurement procedures will be described.

A schematic diagram, a location of components drawing and a detailed electrical parts list are provided in the Appendix of this manual to assist in troubleshooting the supply.

4.2 CALIBRATION

All the internal controls of this instrument have been preset prior to shipment from the factory. Recalibration of the voltmeter/ammeter should be made at intervals of approximately 1 year. Calibration adjustments must be made if the power supply has been subject to a failure that required a component replacement. Calibration control function and location on the printed circuit assembly can be easily found by referring to the location of components drawing in the Appendix of this manual.

Remove the bottom plate from the power supply to allow access to the calibration controls. Turn the unit on and allow for a 30 minute stabilization period prior to proceeding with the calibration adjustments.

4.2.1 EQUIPMENT REQUIRED

- (1) 5 1/2 digit digital voltmeter with better than 0.1% accuracy.
- (2) DC ammeter, 0-2 amperes with better than 0.5% accuracy.
- (3) Electronic or resistance load.

4.2.2 ZERO VOLTAGE CALIBRATION

- (1) Connect the DVM across the output of the supply.
- (2) Set the decade switches for zero volts output. Set the vernier control completely counterclockwise.
- (3) Turn the AC switch to the ON position.
- (4) Set the zero volts ADJ. ((R42) so that DVM indicates zero volts ± 50 microvolts.

4.2.3 MAXIMUM VOLTAGE ADJUSTMENT

NOTE: Make this adjustment only after the zero voltage calibration.

- (1) Set the decade switches to the maximum output voltage position. On the Model 2020B set the 10-20 volt switch to the 20 volt position.
- (2) Set the vernier control fully counterclockwise.
- (3) Connect the DVM across the output supply.
- (4) Adjust the CALIBRATE pot (R43) to achieve the following results:
Model 2020B = 20.000 \pm .001 volts
Model 5020 = 50.000 \pm .001 volts
Model C500 = 100.000 \pm .001 volts

4.2.4 MAXIMUM CURRENT ADJUSTMENT

- (1) Connect an ammeter capable of reading 2.5 amperes accurately across the power supply output.
- (2) Set the output voltage decade to a value greater than 1 volt.
- (3) Set the front panel current limit control fully clockwise.
- (4) Turn the power supply on and adjust trimpot R8 for an output current 5% higher than the maximum rating of the supply.
(ie. 2.1A for a 2 ampere supply)

4.2.5 AMMETER CALIBRATION

- (1) With the external calibrating ammeter connected as in the preceding step (4.2.4) adjust the front panel CURRENT LIMIT control so that the external meter indicates 1 ampere (for the Models 2020B and 5020) or 250ma (for the Model C500).
- (2) Set the meter function switch to the "A" position.
- (3) Adjust R22 so that panel meter agrees with external ammeter.

4.3 POWER SUPPLY MEASUREMENT TECHNIQUES

4.3.1 General

Power supply performance measurements require special techniques to insure correct results. The correct location of instrumentation leads is critical, since voltage drops due to contact resistance and load current flow may lead to misleading results. Four terminal network techniques as shown in Figure 1 and 2 must be employed to achieve correct measurements.

In addition to the equipment listed in 4.2.1, the following are required:

- (1) Adjustable AC input source (Variac) with provisions for accurately monitoring the AC input voltage.
- (2) Oscilloscope with a bandwidth of not more than 10 MHz and a vertical sensitivity of at least 1mV/cm.

4.3.2 Definitions

- (1) Line Regulation: The change in output voltage (constant voltage mode) or current (constant current mode) when varying the AC input voltage through its specified range with a fixed load.
- (2) Load Regulation: The change in output voltage (constant voltage mode) or current (constant current mode) with a specific step change in load resistance.
- (3) Ripple: Any AC component that rides on the DC output of the supply. It is usually synchronized with the input AC source frequency.

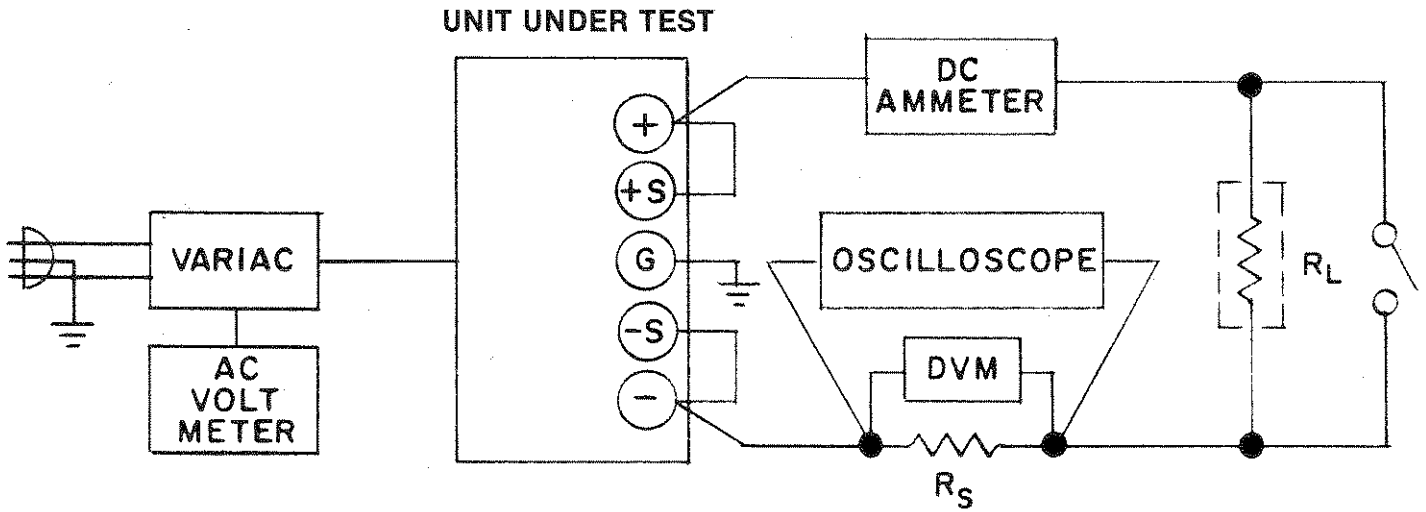

CONSTANT CURRENT MEASUREMENTS

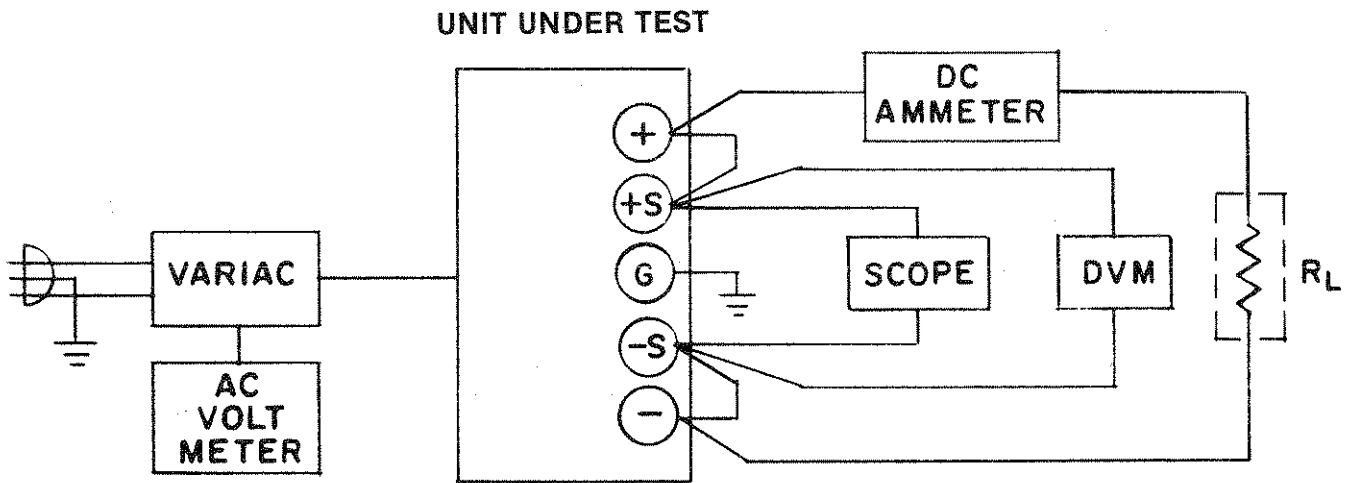

CONSTANT VOLTAGE MEASUREMENTS

FIGURE 1

4.4 TROUBLESHOOTING

When attempting to troubleshoot this unit on a service bench, make sure that the shorting links between DC + and S +, DC - and S -, RV1 and RV2 and RC1 and RC2 are installed and adequately tightened.

Measure the voltages indicated on the schematic as a first step when troubleshooting the supply. These voltages should appear when the power supply is turned on and the output voltage, current and crowbar controls are set fully clockwise.

4.4.1 No Output

- (1) If the AC light does not come on, check that the power supply is connected to a live source of AC power of the proper voltage. Also check that the AC fuse on the rear panel is not open.
- (2) Check that the DC fuse located on the printed circuit board assembly is not open.

4.4.2 High Output

- (1) Shorted series regulator transistor or a shorted driver transistor.
- (2) Open sensing links or remote voltage links on the rear terminal strip will cause a high output voltage prior to the overvoltage crowbar tripping.

4.4.3 Poor Performance

- (1) Excessive output voltage or current variations are usually the result of improper measurement techniques. Use the method described in 4.3 to measure power supply performance.
- (2) High ripple at the output or the load when remote sensing may be due to long leads that are not twisted tightly and shielded. This condition may result in oscillation. A 20 microfarad electrolytic capacitor of the appropriate voltage rating should be connected in parallel with the load.

SECTION 5 APPENDIX

5.1 GENERAL

This section contains the schematic diagram, a location of components drawing and an electrical parts list.

All electrical parts are listed in the sequence of their circuit designation numbers as shown on the schematic diagram.

All components used in the power supply or supplied as replacements are carefully inspected at the factory. Inspections are performed on a 100% basis or at AQL levels to Military Specification MIL-Q-9858 under which Power Designs, Inc. has been qualified.

All semiconductors are inspected on a 100% basis, not only for operating parameters, but also for critical characteristics related to reliability and predictable life expectancy. Some of these characteristics are observed when the device is taken beyond its normal operating regions. These test techniques have been developed under a "predictable reliability" program in operation at Power Designs, Inc. for the past twelve years. Under this program, quality control procedures are constantly revalued and updated as advances are made in solid state technology and experience is gained from field history.

Semiconductor manufacturers are continually modifying their products. Complete lines are discontinued to be replaced by devices having improved gain, operating voltage levels and frequency responses. The high gain, closed loop DC amplifiers used in regulator circuits are particularly sensitive to slight changes in these parameters. Commercial or military "equivalent" transistors may affect the performance of the power supply. We can assure compliance with the original specifications if replacement semiconductors are ordered from the factory.

All replacement semiconductors are processed and stocked at the factory to insure complete interchangeability with the devices in the original equipment.

When ordering replacements, please identify the device as thoroughly as possible, giving the model and serial number if available.

ELECTRICAL PARTS LIST

Circuit No.	Description	Part No.
A1*	55, 56 Switch Assembly (see separate parts lists)	PS-2010-15
A1**		PS-5020-15
A1***		PS-C500-7
C1	Capacitor, electrolytic, 1 mf, 100 vdc	CE-59-1
C2	Capacitor, plastic film, 0.022 mfd, 200 v	CP-A022-2
C3	Capacitor, electrolytic, 1 mf, 100 vdc	CE-59-1
C4	Capacitor, electrolytic, 300 mf, 40 vdc	CE-301-40
C5	Capacitor, electrolytic, 1 mf, 100 vdc	CE-59-1
C6, C7	Capacitor, electrolytic, 6.8 mf, 35 vdc	CE-6A8-.35
C8	Capacitor, electrolytic, 15 mf, 20 vdc	CE-15-20
C9*	Capacitor, plastic film, 0.001 mf, 200 vdc	CP-24-2
C10*	Capacitor, ceramic disc, 100 pf, 1 kvdc	CC-A001-102
C11	Capacitor, plastic film, 0.1 mf, 200 vdc	CP-17-2
C12	Capacitor, plastic film, 0.0047 mf, 200 vdc	CP-26-2
C13	Capacitor, tantalytic, 6.8 mfd, 35 vdc	CE-6A8-.35
C13***	Capacitor, tantalytic, 15 mfd, 20 vdc	CE-15-20
C17*	Capacitor, electrolytic, 2200 mf, 50 vdc	CE-222-50
C17	Capacitor, plastic film, 0.047, 200 vdc	CP-32-2
C18	Capacitor, tantalytic, 15 mf, 20 vdc	CE-15-20
C19	Capacitor, tantalytic, 33 mf, 10 vdc	CE-33-10
C20	Capacitor, metal polyester, 4 mf, 150 vdc	CP-4-151
C21*	Capacitor, electrolytic, 270 mf, 25 vdc	CLX-270-25
C21**	Capacitor, electrolytic, 310 mf, 50 vdc	CE-311-50
C21***	Capacitor, electrolytic, 40 mf, 150 vdc	CE-40-150
C22	Capacitor, tantalytic, 33 mf, 10 vdc	CE-33-.10
C24	Capacitor, tantalytic, 1 mf, 50 vdc	CE-1-500
C25	Capacitor, tantalytic, 6.8 mf, 35 vdc	CE-6A8-.35
C26	Capacitor, plastic film, 0.0022 mf, 50 vdc	CP-A0022-2
C27**	Capacitor, plastic film, 0.047 mf, 200 vdc	CP-32-2
C28	Capacitor, plastic film, 0.1 mf, 200 vdc	CP-17-2
C32, C33**	Capacitor, electrolytic, 2200 mf, 50 vdc	CE-222-50
C32, C33***	Capacitor, electrolytic, 400 mf, 85 vdc	CE-83-.85
C34**	Capacitor, electrolytic, 1 mf, 100 vdc	CE-59-1
C34***	Capacitor, electrolytic, 1 mf, 150 vdc	CE-1-150
C101*	Capacitor, electrolytic, 1 mf, 50 vdc	CE-1-500
CR1-CR4	Diode, rectifier	FS-88
CR5	Diode, rectifier	GI-44
CR6	Diode, rectifier	FS-88
CR7-CR8	Diode, rectifier	FS-88
CR7-CR8**	Diode, rectifier	GI-44
CR9	Diode, rectifier	FS-88
CR10-CR11	Diode, rectifier	SI-5A2
CR10-CR11**	Diode, rectifier	FS-88
CR12-CR13	Diode, rectifier	GI-44
CR14	Diode, rectifier	SI-5A2
CR15	Diode, rectifier	GI-44
CR16**	Diode, rectifier	FS-88
CR17-CR21	Diode, rectifier	SI-5A2
DS1	Indicator lamp (amber)	PLA-14
DS2*	Indicator lamp (amber)	PLA-14
DS2	Indicator lamp (clear)	PLA-15
F1	Fuse, 2A-250v, slo-blo	MDX-2
F2	Fuse, 3A-250v, slo-blo	MDX-3
F2***	Fuse, 1A-250v, slo-blo	MDL-1
M1*	Meter	MVA-167
M1**	Meter	MVA-162
M1***	Meter	MVA-163

*Used on Model 2020B
 **Used on Model 5020
 ***Used on Model C500

ELECTRICAL PARTS LIST

Circuit No.	Description	Part No.
Q1	Transistor, silicon, NPN	FS-1700E
Q2*	Transistor, silicon, NPN	2N2219A
Q2	Transistor, silicon, NPN	TI-0421
Q3	Transistor, silicon, NPN	2N2219A
Q4*	Transistor, silicon, NPN	FS-2270B
Q5*	Transistor, silicon, NPN	FS-1700E
Q5-Q7**	Transistor, silicon, NPN	FS-1700E
Q5-Q7***	Transistor, silicon, NPN	IR-4230
Q6, Q7*	Transistor, silicon, NPN	MS-1700G
Q8	Transistor, silicon, NPN	MS-1700G
Q9	Transistor, silicon, NPN	FS-1075
Q10	Transistor, silicon, NPN	MS-1700G
Q11	Transistor, silicon, PNP	2N5416
R1	Resistor, precision metal film, 90.9K, $\pm 1\%$, $\frac{1}{4}$ w	RD-9092-1QA
R2	Resistor, precision metal film, 1M ohm, $\pm 1\%$, $\frac{1}{4}$ w	RD-105-1QA
R3*	Resistor, precision metal film, 3.32K, $\pm 1\%$, $\frac{1}{4}$ w	RD-3321-1QA
R3	Resistor, precision metal film, 2.43K, $\pm 1\%$, $\frac{1}{4}$ w	RD-2431-1QA
R4-R5	Resistor, precision metal film, 6.04K, $\pm 1\%$, $\frac{1}{4}$ w	RD-6041-1QA
R6	Resistor, precision metal film, 1K, $\pm 1\%$, $\frac{1}{4}$ w	RD-1001-1QA
R7	Resistor, precision metal film, 32.4K, $\pm 1\%$, $\frac{1}{4}$ w	RD-3242-1QA
R8	Resistor, wirewound trimmer, 5K, $\pm 10\%$, $\frac{1}{2}$ w	RWT-502-4A
R9	Resistor, precision metal film, 22.1K, $\pm 1\%$, $\frac{1}{4}$ w	RD-2212-1QA
R10	Resistor, precision metal film, 1K, $\pm 1\%$, $\frac{1}{4}$ w	RD-1001-1QA
R11*	Resistor, precision metal film, 1K, $\pm 1\%$, $\frac{1}{4}$ w	RD-1001-1QA
R11	Resistor, composition, 4.7K, $\pm 10\%$, $\frac{1}{2}$ w	EB-4721
R12*	Resistor, precision metal film, 1K, $\pm 1\%$, $\frac{1}{4}$ w	RD-1001-1QA
R13	Resistor, composition, 3.3K, $\pm 10\%$, $\frac{1}{2}$ w	EB-3321
R14	Resistor, precision metal film, 1.58K, $\pm 1\%$, $\frac{1}{4}$ w	RD-1581-1QA
R15*	Resistor, composition, 47 ohm, $\pm 10\%$, $\frac{1}{2}$ w	EB-471
R16*	Resistor, composition, 10K, $\pm 10\%$, $\frac{1}{2}$ w	EB-1031
R16**	Resistor, precision metal film, 1.4K, $\pm 1\%$, $\frac{1}{4}$ w	RD-1421-1QA
R16***	Resistor, precision metal film, 1.58K, $\pm 1\%$, $\frac{1}{4}$ w	RD-1581-1QA
R17-R18*	Resistor, wirewound, 0.75 ohm $\pm 5\%$, 3w	RW-F75-3KA
R17**	Resistor, precision metal film, 1.21K, $\pm 1\%$, $\frac{1}{4}$ w	RD-1211-1QA
R17***	Resistor, precision metal film, 1K $\pm 1\%$, $\frac{1}{4}$ w	RD-1001-1QA
R18**	Resistor, precision metal film, 15K, $\pm 1\%$, $\frac{1}{4}$ w	RD-1502-1QA
R19	Resistor, precision metal film, 1K, $\pm 1\%$, $\frac{1}{4}$ w	RD-1001-1QA
R20	Resistor, precision metal film, 909 ohm, $\pm 1\%$, $\frac{1}{4}$ w	RD-9090-1QA
R21	Resistor, precision metal film, 280 ohm, $\pm 1\%$, $\frac{1}{4}$ w	RD-2810-1QA
R21***	Resistor, precision metal film, 332 ohm, $\pm 1\%$, $\frac{1}{4}$ w	RD-3320-1QA
R22	Resistor, wirewound trimmer, 200 ohm, $\pm 10\%$, $\frac{1}{2}$ w	RWT-201-4A
R23*	Resistor, precision metal film, 100 ohm, $\pm 1\%$, $\frac{1}{4}$ w	RD-101-1QA
R23**	Resistor, precision metal film, 1K, $\pm 1\%$, $\frac{1}{4}$ w	RD-1001-1QA
R24	Resistor, wirewound, 0.22 ohm, $\pm 5\%$, 3w	RW-F22-3KA
R24***	Resistor, wirewound, 1 ohm, $\pm 5\%$, 3w	RW-010-3KA
R25	Resistor, precision metal film, 2.1K, $\pm 1\%$, $\frac{1}{4}$ w	RD-212-1QA
R26	Resistor, precision metal film, 10K, $\pm 1\%$, $\frac{1}{4}$ w	RD-103-1QA
R27	Resistor, precision metal film, 475 ohm, $\pm 1\%$, $\frac{1}{4}$ w	RD-4750-1QA
R28	Resistor, precision metal film, 3.32K, $\pm 1\%$, $\frac{1}{4}$ w	RD-3321-1QA
R29	Resistor, precision metal film, 6.04K, $\pm 1\%$, $\frac{1}{4}$ w	RD-6041-1QA
R30	Resistor, precision metal film, 43.2 ohm, $\pm 1\%$, $\frac{1}{4}$ w	RD-43F2-1QA
R31	Resistor, composition, 10K, $\pm 10\%$, $\frac{1}{2}$ w	EB-103
R32	Resistor, composition, 1K, $\pm 10\%$, $\frac{1}{2}$ w	EB-102
R33	Resistor, composition, 10K, $\pm 10\%$, $\frac{1}{2}$ w	EB-103
R34	Resistor, precision, wirewound (matched component, see end of parts list)	
R35	Resistor, precision metal film, 154K, $\pm 0.25\%$, $\frac{1}{4}$ w	RD-1543-11QA

* Used on Model 202B

** Used on Model 5020

*** Used on Model C500

ELECTRICAL PARTS LIST

Circuit No.	Description	Part No.
R36*	Resistor, composition, 2.2K, $\pm 10\%$, $\frac{1}{2}$ w	EB-2221
R36**	Resistor, composition, 10K, $\pm 10\%$, $\frac{1}{2}$ w	EB-1011
R36***	Resistor, composition, 39K, $\pm 10\%$, $\frac{1}{2}$ w	EB-3931
R37*	Resistor, metal film, 19.1K $\pm 1\%$, $\frac{1}{4}$ w	RD-1912-1QA
R37**	Resistor, metal film, 49K, $\pm 1\%$, $\frac{1}{4}$ w	RD-4912-1QA
R37***	Resistor, metal film, 100K $\pm 1\%$, $\frac{1}{4}$ w	RD-104-1QA
R38	Resistor, wirewound, 0.15 ohm, $\pm 5\%$, 3w	RW-F15-3KA
R38***	Resistor, wirewound, 0.44 ohm, $\pm 5\%$, 3w	RW-F44-3KA
R39*	Resistor, precision metal film, 1K, $\pm 1\%$, $\frac{1}{4}$ w	RD-1001-1QA
R41	Potentiometer, 1K, $\pm 10\%$, 2w (part of S4)	B68057-1
R42, R43	Potentiometer, 20K, $\pm 5\%$, 2w (10 turn)	RWV-203-3C10
R44	Resistor, composition, 100 ohm, $\pm 10\%$, $\frac{1}{2}$ w	EB-1011
R45*	Resistor, composition, 180K, $\pm 10\%$, $\frac{1}{2}$ w	EB-1841
R45	Resistor, precision metal film, 1K, $\pm 1\%$, $\frac{1}{4}$ w	RD-1001-1QA
R46*	Resistor, precision metal film, 475K, $\pm 1\%$, $\frac{1}{4}$ w	RD-4753-1QA
R46, R47**	Resistor, wirewound, 0.75 ohm, $\pm 5\%$, 3w	RW-F75-3KA
R46, R47***	Resistor, wirewound, 1.5 ohm, $\pm 5\%$, 3w	RW-1F5-3KA
R48	Resistor, precision metal film, 100 ohm, $\pm 1\%$, $\frac{1}{4}$ w	RD-101-1QA
R101*	Resistor, composition, 150K, $\pm 10\%$, $\frac{1}{2}$ w	EB-1541
R102, R102*	Resistor, composition, 4.7K, $\pm 10\%$, $\frac{1}{2}$ w	EB-4721
R104*	Resistor, wirewound trimmer, 20K, $\pm 10\%$, $\frac{1}{2}$ w	RWT-203-4A

NOTE: The following resistors are used only in the Models 5020 and C500

R49**	Resistor, composition, 22K, $\pm 10\%$, $\frac{1}{2}$ w	EB-2231
R49***	Resistor, composition, 150K, $\pm 10\%$, $\frac{1}{2}$ w	EB-1541
R72**	Resistor, precision metal film, 1K, $\pm 1\%$, $\frac{1}{4}$ w	RD-1001-1QA
R73	Resistor, metal film, 100 ohm, $\pm 1\%$, $\frac{1}{4}$ w	RD-102-1QA
R74**	Resistor, wirewound, 0.5 ohm, $\pm 5\%$, 7w	RW-F5-3RA
R74***	Resistor, wirewound, 1.5 ohm, $\pm 5\%$, 3w	Rw-1F5-3KA
R75	Resistor, precision metal film, 475K, $\pm 1\%$, $\frac{1}{4}$ w	RD-4753-1QA
R76**	Potentiometer, 10 ohm, $+0\%/-10\%$, 2w, 10 turn	RWV-110-3C10L
R77**	Resistor, wirewound trimmer, 5K, $\pm 10\%$, $\frac{1}{2}$ w	RWT-502-4A
R78**	Resistor, precision metal film, 121K, $\pm 1\%$, $\frac{1}{4}$ w	RD-1213-1QA
R79**	Resistor, composition, 33 ohm, $+10\%$, $\frac{1}{2}$ w	EB-3301
R80**	Resistor, wirewound, 0.75 ohm, $\pm 5\%$, 3w	RW-F75-3KA
S1	Toggle switch-SPST	ST-5
S2	Toggle switch-DPDT	ST-39
S3*	Toggle switch-DPDT	ST-36
S4	Switch-SPST (part of S4/R4 ass'y)	B68057-1
T1	Transformer	TTM-5020K-1
T1***	Transformer	TTM-C500K-1
U1	Integrated circuit	LH358H or UA798HC
U2	Integrated circuit	OP-05CP
U3	Integrated circuit (matched component)	see below
VR1	Diode, zener	DZE, F, G
VR2	Diode, zener	3EZ10D5
VR3	Diode, zener	3EZ5.6D5

U3, R34 Matched Components

When U3 is A-65555-1, R34 is 6.87K, $\pm 0.1\%$, 0.3w	RWA-6871-8SD
When U3 is A-65555-2, R34 is 7.09K, $\pm 0.1\%$, 0.3w	RWA-7091-8SD
When U3 is A-65555-3, R34 is 7.32K, $\pm 0.1\%$, 0.3w	RWA-7321-8SD

* Used on Model 2020B

**Used on Model 5020

***Used on Model C500

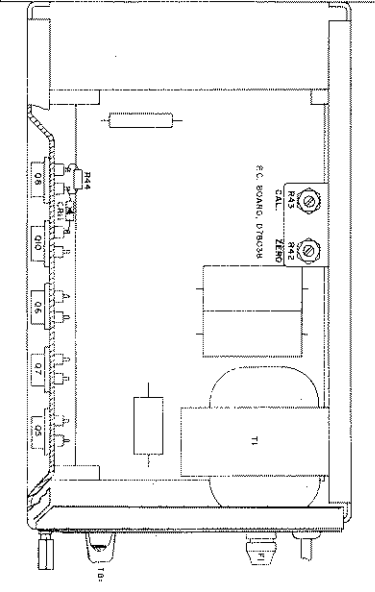
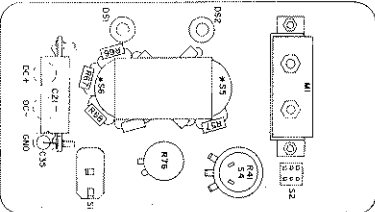
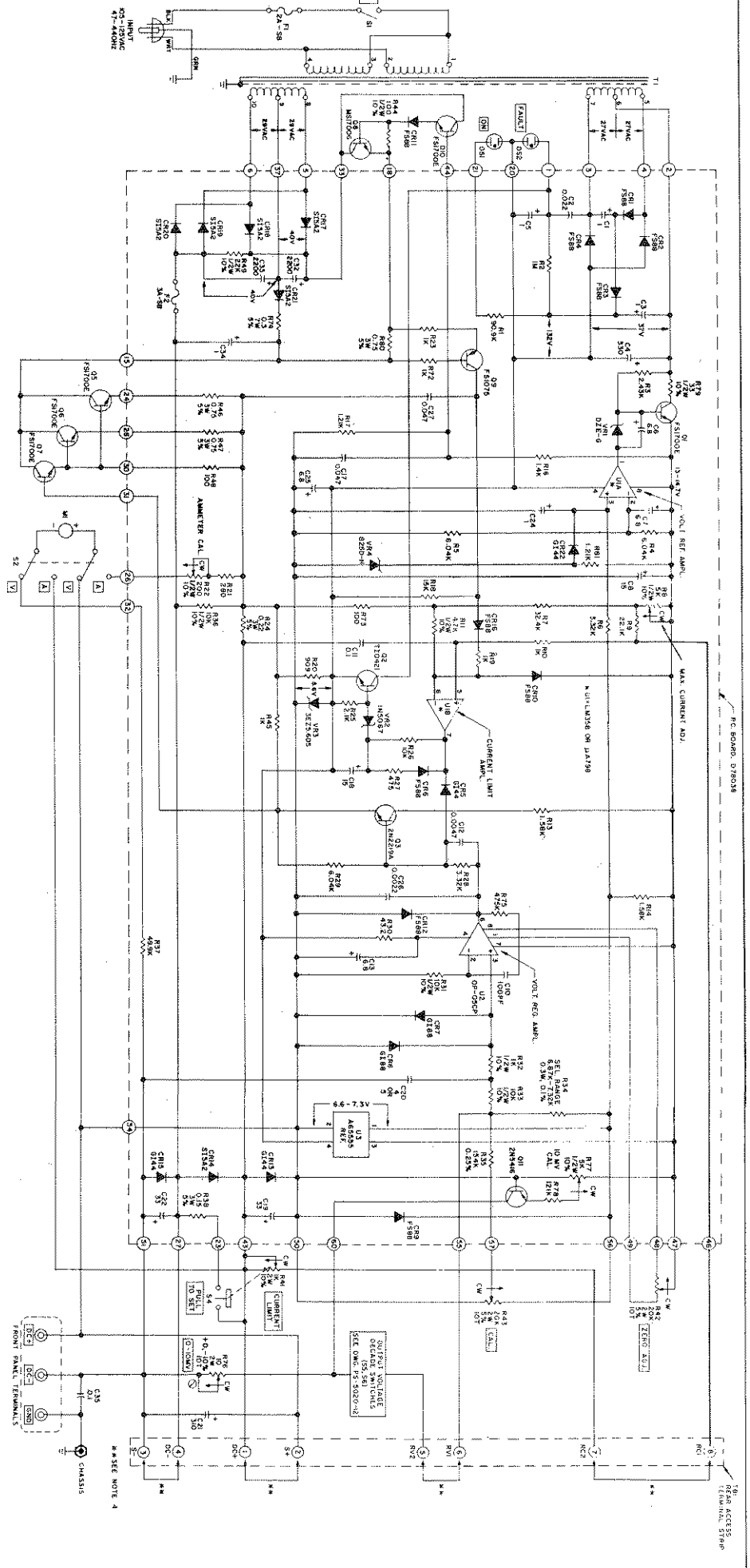

NOTES:

1. UNLESS OTHERWISE SPECIFIED, ALL COMPONENTS ARE TO BE PURCHASED FROM THE MANUFACTURER'S RECOMMENDED SOURCE.
2. ALL VOLTAGES REFERRED TO COMMON UNLESS OTHERWISE NOTED.
3. NUMERALS IN CIRCLES THAT ARE CONNECTED BY DASH LINES INDICATE SHORTHING LINKS ARE SHOWN FOR NORMAL OPERATION.

NOTE:

PRINTS HAVE BEEN GRANTED PATENT APPLICATIONS ARE BEING MADE IN PROCESS OF PREPARATION ON THE BASIS OF THIS DRAWING. REPRODUCTION IN WHOLE OR IN PART MAY NOT BE MADE WITHOUT PERMISSION.

REV.	DATE	BY	CHKD.	DESCRIPTION
1				ISSUED
2				REVISED ECU 3071
3				REVISED ECU 3071
4				REVISED ECU 3071
5				REVISED ECU 3071
6				REVISED ECU 3071
7				REVISED ECU 3071
8				REVISED ECU 3071
9				REVISED ECU 3071
10				REVISED ECU 3071

DRAWING NO. PS-5020-1
 TITLE SCHEMATIC MODEL 5020

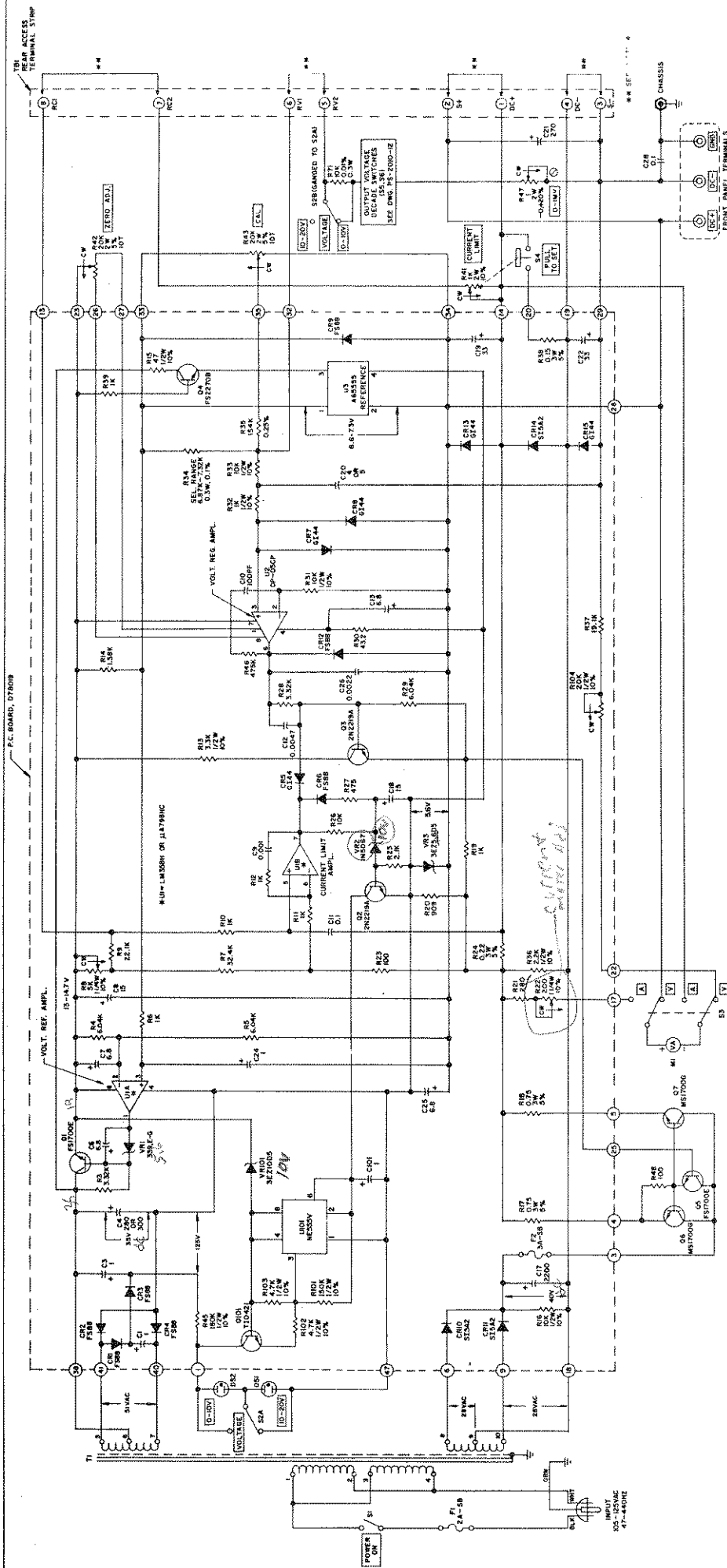

- NOTES:
1. UNLESS OTHERWISE SPECIFIED, ALL CAPACITORS ARE IN MICROFARADS.
 2. ALL VOLTAGES REFERENCE TO COMMON.
 3. RECTANGLES IN CIRCLES THAT ARE SHOWN IN THE SCHEMATIC ARE CONNECTED BY DASH LINES INDICATE PC BOARD TERMINAL NUMBERS.
 4. SHORTING LINES ARE SHOWN FOR NORMAL OPERATION.

REVISED ECM 3115	DATE	BY
REVISED ECM 3191	DATE	BY
REVISED ECM 3073	DATE	BY
REVISED ECM 3027	DATE	BY
RELEASED	DATE	BY

DRAWING NO. PS-2020B-1
 TITLE SCHEMATIC MODEL 2020B
 AUTHORITY
 APPROVED
 DATE
 BY

NOTICE
 PATENTS HAVE BEEN GRANTED. WHERE APPLICABLE, THE PROPER PATENT NUMBERS AND THE NAMES OF THE PATENT OWNERS SHOULD BE SHOWN IN THE APPROPRIATE PORTIONS OF THE SCHEMATIC. THIS DRAWING IS UNCLASSIFIED AND IS IN THE PUBLIC DOMAIN. IT MAY NOT BE MADE WITHOUT PERMISSION.

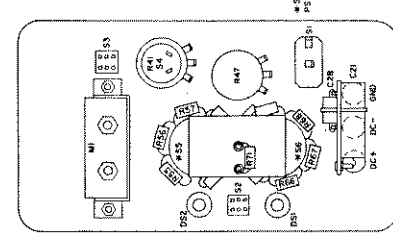
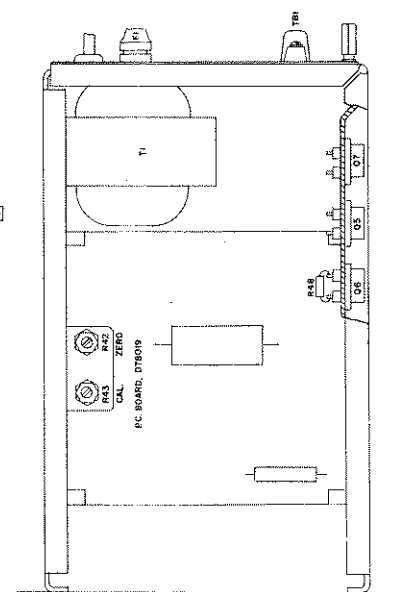

LOCATION OF COMPONENTS

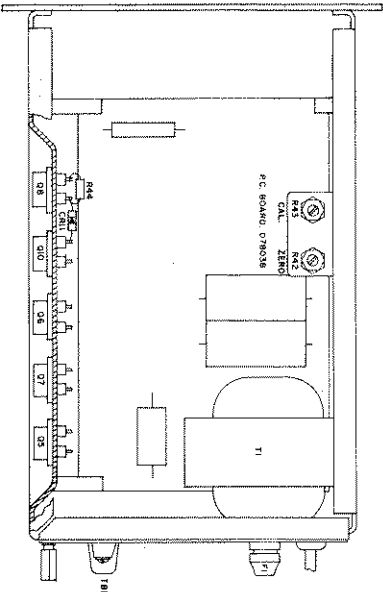
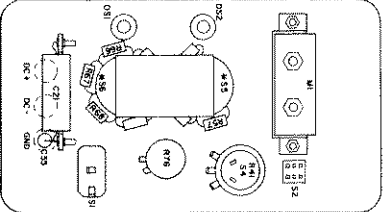
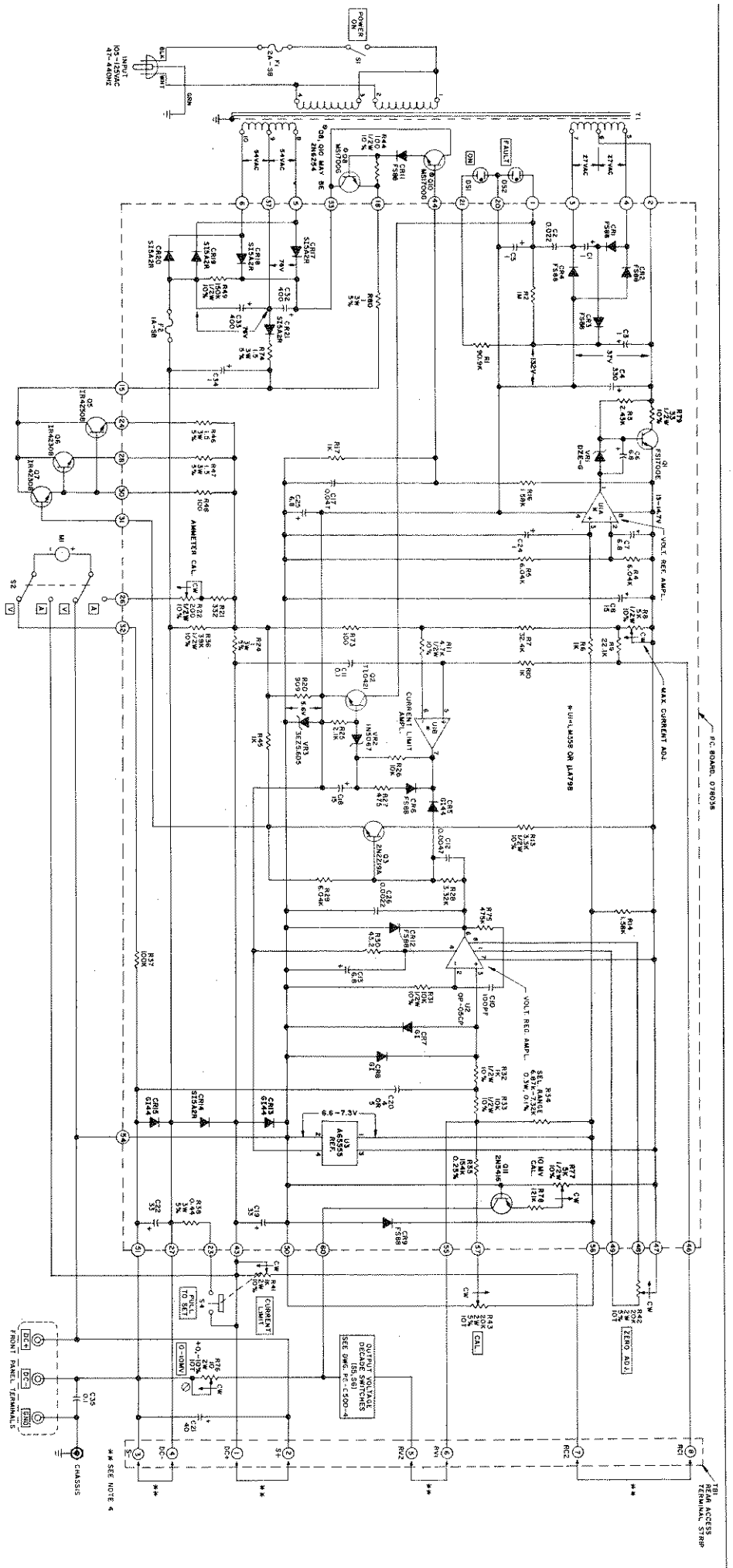

- NOTES:
1. VALUES OF COMPONENTS SHOWN.
 2. ALL CAPACITORS ARE IN MICROFARADS.
 3. ALL RESISTORS ARE IN OHMS, UNLESS OTHERWISE SPECIFIED.
 4. ALL COMPONENTS ARE IN MICROFARADS.
 5. ALL FROM FRONT PANEL CONTROL FUNCTIONS ARE SHOWN IN RECTANGLES IN CIRCLES THAT ARE CONNECTED BY DASH LINES INDICATE REPAIRABLES.
 6. SCHEMATIC VALUES ARE SHOWN FOR NORMAL OPERATION.
 7. SHORTING LINKS ARE SHOWN FOR NORMAL OPERATION.

NOTICE

PATENTS HAVE BEEN GRANTED. PATENT APPLICATIONS ARE PENDING IN THE UNITED STATES AND IN FOREIGN COUNTRIES. THIS DRAWING, REPRODUCTION IN WHOLE OR IN PART MAY NOT BE MADE WITHOUT PERMISSION.

REV.	DATE	BY	CHKD.	DESCRIPTION
1	11/17/50	W. J. B.	W. J. B.	INITIAL DESIGN
2	12/15/50	W. J. B.	W. J. B.	REVISED FOR MANUFACTURE
3	1/10/51	W. J. B.	W. J. B.	REVISED FOR MANUFACTURE
4	1/10/51	W. J. B.	W. J. B.	REVISED FOR MANUFACTURE
5	1/10/51	W. J. B.	W. J. B.	REVISED FOR MANUFACTURE
6	1/10/51	W. J. B.	W. J. B.	REVISED FOR MANUFACTURE
7	1/10/51	W. J. B.	W. J. B.	REVISED FOR MANUFACTURE
8	1/10/51	W. J. B.	W. J. B.	REVISED FOR MANUFACTURE
9	1/10/51	W. J. B.	W. J. B.	REVISED FOR MANUFACTURE
10	1/10/51	W. J. B.	W. J. B.	REVISED FOR MANUFACTURE

DRAWING NO. CS-5200-1

TITLE SCHEMATIC, MODEL CS00

NEW YORK

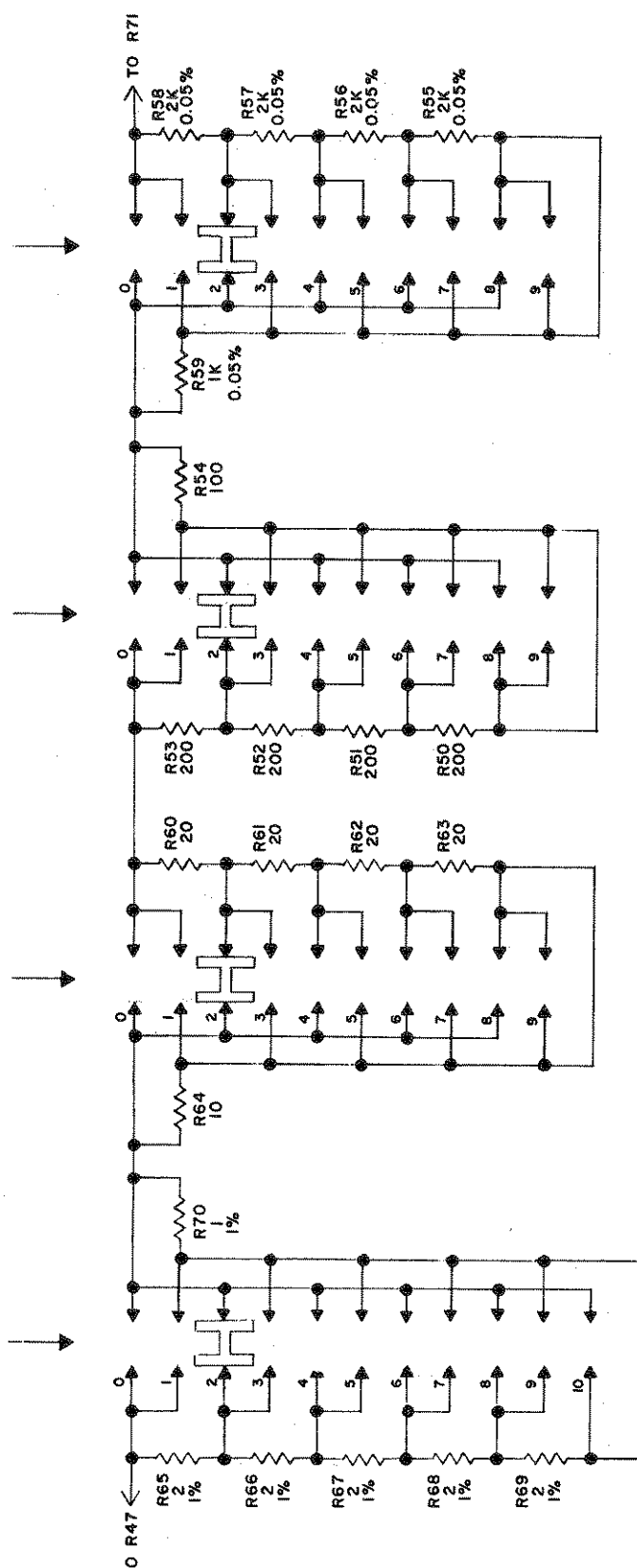
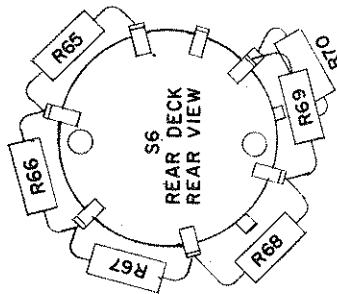
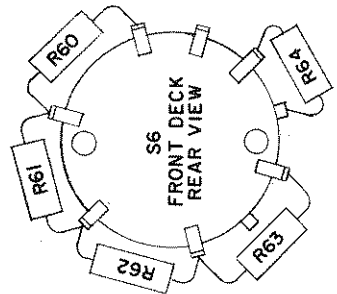
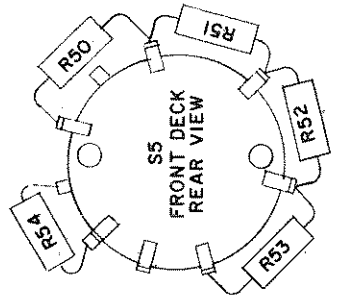
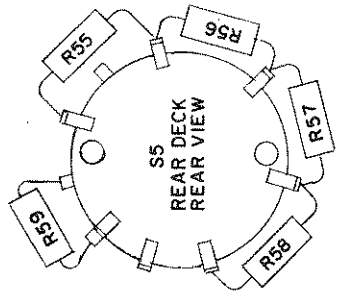

SYMBOL	RELEASED	DESCRIPTION	REV.	DATE
A		PS-2010-12		
REVISIONS				
DRAWING NO. PS-2010-12				
TITLE S5 & S6 SWITCH SCHEMATIC				
DRAWN	HC	CHECKED	APPROVED	
DATE	1/15/79	DATE	DATE	DATE

NOTE:
 1. VOLTAGE CONTROL WIRING FOR MODELS 2010 & 2020B.
 2. ALL SWITCH ROTORS ARE MAKE-BEFORE-BREAK.
 3. UNLESS OTHERWISE SPECIFIED ALL RESISTORS ARE IN OHMS, 0.1%, 0.1%, 0.3W.



GUARANTEE

POWER DESIGNS INC. guarantees to the original purchaser, each instrument sold by us, or our authorized agents, and all the parts thereof, to be free from defects in material or workmanship under normal use and service within the specified ratings and operating conditions. The provisions of this warranty shall not apply to any product which has been subjected to misuse or which has been repaired or altered in any way by the purchaser.

POWER DESIGNS' obligations under this guarantee is hereby limited to the repair or replacement of the instrument, or part thereof, which is returned to us by the original owner within five (5) years after date of shipment, and which shall prove, after our examination to be defective. Certain product categories as listed are limited to a one (1) year guarantee. All other terms and conditions shall apply.

A minimum retest and inspection charge of \$50.00 will be applicable to units returned for repair in warranty unless the unit is found to be defective.

All products returned under warranty must be shipped prepaid to the factory with documentation explaining the malfunction noted. The units will be evaluated, repaired or replaced and promptly returned prepaid if warranty claims are substantiated.

Products covered by a five year guarantee include Regulated Low Voltage D.C. Laboratory Power Supplies; Precision Low Voltage Power Sources; Low Voltage NIM Power Sources.

Products covered by a one year guarantee include Precision High Voltage Power Sources; Modular High Voltage Power Sources; Special Purpose Power Sources: Custom OEM Power Supplies.

POWER DESIGNS INC., reserves the right to discontinue any instrument without notice, or to make modifications in design at any time, without incurring any obligation to make these modifications in instruments previously sold.

POWER DESIGNS INC
Westbury, L.I., New York