

SBE SB-36 OPERATION MANUAL



SB-36 OPERATION MANUAL

Remastered by NoobowSystems Lab. Tomioka, Japan 2003 Rev.00

<http://www.noobowsystems.com>

PRELIMINARY VERSION

SBE SB-36 OPERATION MANUAL

WARRANTY

Linear Systems, Inc. warrants equipment manufactured by it to be free from defects in material or workmanship and agrees to repair such equipment which under normal use and service, develops defects arising from the fault of the manufacturer. Equipment must be returned transportation prepaid within 90 days from the date of original purchase, and unless the warranty card has been filled in and returned within ten days of original purchase, the warranty shall be void.

This warranty does not apply to equipment which (1) has been repaired or altered by anyone in any way so as, in our judgment, to injure its stability or reliability, (2) has been subject to misuse, negligence, or accident, (3) has had the serial number altered defaced, or removed, or (4) has been connected, installed, adjusted otherwise than in accordance with our written instructions.

The foregoing is in lieu of any other warranty or liability expressed, implied, or statutory and in no event shall Linear Systems, Inc. be liable for special or consequential damages. Linear Systems, Inc. neither assumes nor authorizes any person to assume for it any other obligation or liability in connection with this equipment.

LINEAR SYSTEMS, INC.
220 Airport Boulevard
Watsonville, California 95076
(408) 722-4177

NoobowSystems Lab. Remastering Information

Revision 0.0	Aug.11, 2003	Preliminary release, some pages are missing.

SBE SB-36 OPERATION MANUAL

Paragraph	TABLE OF CONTENTS	Page
	Section I General Description	
1.1	General	1
1.2	Specifications	1
1.2.1	General	1
1.2.2	Transmitter	1
1.2.3	Receiver	2
	Section II In starvation	
2.1	General	3
2.2	Fixed Station	3
2.3	Antennas	3
2.4	Linear Amplifier	3
	Section III Operation	
3.1	Operation Instructions	4
	Section IV Operating Procedure	
4.1	Receiver Operation	11
4.2	Transmitter Tuning Procedure	11
4.3	CW operation	12
	Section V Theory of Operation	
5.1	General	13
5.2	Transmitter circuitry	13
5.3	Receiver Circuitry	16

Table of Contents

1.0 INTRODUCTION.....	5
1.1 GENERAL.....	5
1.2 SPECIFICATIONS.....	5
1.2.1.....	General
.....	5
1.2.2.....	Transmitter
.....	6
2.0 INSTALLATION.....	7
2.1 GENERAL.....	7
2.2 FIXED STATION.....	7
2.3 ANTENNAS.....	7
2.4 LINEAR AMPLIFIER.....	7
3.0 OPERATION.....	8
3.1 OPERATING INSTRUCTIONS.....	8
3.1.1.....	8
4.0 OPERATING PROCEDURE.....	14
WARNING:.....	14
4.1 RECEIVER OPERATION.....	14
4.2 TRANSMIT TUNING PROCEDURE.....	14
4.3 CW OPERATION.....	15
5.0 THEORY OF OPERATION.....	17
5.1 GENERAL.....	17
5.1.1.....	17
5.2 TRANSMITTER CIRCUITRY.....	18
5.2.1.....	Transmitter Signal Path
.....	18
5.2.2.....	Automatic Level Control
.....	19
5.3 RECEIVER CIRCUITRY.....	19
5.3.1.....	Receiver Signal Path
.....	19
5.3.2.....	Noise Blanker
.....	20
5.3.3.....	Automatic Gain Control
.....	20
5.3.4.....	VOX Keying
.....	21
5.3.5.....	Frequency Mixing Network
.....	21
5.3.5.1.....	Carrier Oscillator
.....	22
5.3.5.2.....	VFO Oscillator
.....	22
5.3.5.3.....	High Frequency Oscillator
.....	23
5.3.5.4 Side Tone Oscillator.....	23
5.3.6.....	Counter
.....	24
5.3.7.....	Power Supply
.....	25

SBE SB-36 OPERATION MANUAL

6.0 MAINTENANCE	27
6.1 INTRODUCTION	27
6.2 PREVENTATIVE MAINTENANCE	27
6.2.1.....	General27
6.2.2.....	Cover Removal27
6.2.3.....	Cleaning27
6.2.4.....	Lubrication28
6.3 TROUBLESHOOTING	28
6.3.1.....	Troubleshooting Techniques28
6.3.2.....	Voltage Table and Injection Points30
6.1.1.....	Receiver DC Voltages - No Signal Input - USB Mode30

SBE SB-36 OPERATION MANUAL

1.0 INTRODUCTION

1.1 GENERAL

The SB-36 Transceiver is a single sideband, suppressed carrier, digital read-out transceiver designed for the professional / amateur radio operator.

The SB-36 is capable of operation in the SSB and CW modes of operation. Frequency coverage includes all amateur bands between 3.0 and 29.7 MHz.

Provisions are made for spare crystals permitting operation in the non-amateur frequencies from 4-7 or 8-14 MHz. Tuning to the precise frequency of operation is accomplished by observing the Arabic numerals being indicated by the nixie tubes while adjusting the VFO control for the desired display.

Included as standard equipment in the SB-36 are VOX, ANTI-VOX, Noise Blanker, and Break-In CW.

The SB-36 consists of a basic transceiver unit and accessory AC Power Supply. The companion AC Power Supply will operate from 117 VAC or 220 VAC, 50/60 Hertz.

The unique digital read-out incorporated in the SB-36 allows direct, accurate, instantaneous frequency read-out to within ± 100 Hz. This accuracy will provide more reliable communications for the serious amateur.

SBE SB-36 OPERATION MANUAL

1.2 SPECIFICATIONS

1.2.1 General

Frequency Range	3.50 - 4.00 MHz 7.00 - 7.50 MHz 14.00 - 14.50 MHz 21.00 - 21.50 MHz 28.00 - 30.00 MHz
Frequency Accuracy	Nixie tube Read-out, accurate to within +100 Hertz on all bands
Dimensions	Transceiver: 13 - 1/4 inches wide 7-1/4 inches high 12-1/2 inches deep Power Supply: 6 inches wide 7-1/4 inches high 12-1/2 inches deep
Weight	Transceiver: 29 pounds Power Supply: 15-1/2 pounds

1.2.2 Transmitter

Power Input	SSB 500 watts, P.E.P. CW 400 watts
Primary Input Voltage	115/220 VAC, 50/60 Hertz
PA cooling Fan	Built. in to PA compartment
Carrier Suppression	-50 db
Distortion Products	-30 db
Modes of Operation	USB, LSB or CW. Selectable from front panel on all frequencies.
Unwanted Sideband	-50 db, @ 1kHz
Antenna impedance	50-100 ohms unbalanced
VSWR	Not to exceed 2:1
Audio Band Width	300-2700 Hertz @ 6 db
Sideband Rejection Filters	Crystal lattice, 9 MHz
Power Consumption	Single Tone Output - 550 watts
Front Panel Meter	Indicates Plate current (Ip), Relative RF Output and ALC

SBE SB-36 OPERATION MANUAL

1.2.3 Receiver

Sensitivity	0.5 microvolts for 10 db S+N/N
Selectivity	2.4 kHz @6 db 4.2 kHz @60 db
Spurious Response	Image and IF responses down at least 50 db
Stability	100 Hertz (or less) per 1/2 hour under any normal ambient condition
Audio Output	2.5 watts @ 10% distortion
Speaker	8 ohms, built into accessory AC Power Supply unit. Rear panel jack provided for external speaker.
Noise Blanker	IF type, switchable from front panel.
Receiver Incremental Tuning (RIT)	± 7 kHz, nominal
Power Consumption	100 watts
Front Panel Meter	Calibrated in "S" units
Ear Phones	Jack on front panel. 600 ohm output.

2.0 INSTALLATION

2.1 GENERAL

The SB-36 Transceiver is designed for Fixed, portable or mobile operation. No special precautions need be observed in choice of a location, provided adequate ventilation is available. A minimum of two inches air space above the top cabinet and on all sides is recommended to allow proper air flow around the top and bottom of the cabinet. Do not place the unit on a car seat or similar surface which might block air flow through the bottom. Never stack other units above or below the cabinet since the accumulated heat could cause permanent damage.

2.2 FIXED STATION

Connect the transceiver's power supply inter-connect cable, speaker cord and plug the 117 VAC power cord into an AC outlet to provide power to all circuits for AC operation. The transceiver should be connected to a good water pipe ground. The ground should be connected to the terminal provided on the rear panel of the transceiver.

2.3 ANTENNAS

Results in both receiving and transmitting are dependent largely on the antenna. The receiver is particularly sensitive to the antenna used. Any of the common antenna systems designed for use on the higher frequency amateur bands may be used with the SB-36 provided the input impedance of the antenna system matches the capability of the pi output matching network (50-100 ohms resistive). If a tuned open-wired transmission line is used, or if a long wire antenna is desired, a suitable antenna tuner must be used between the transceiver and the transmission line to provide an impedance match between the unbalanced pi output network and the balanced open wire line or long wire.

2.4 LINEAR AMPLIFIER

Any conventional linear amplifier requiring 300 watts of drive or less may be used in conjunction with the SB-36. An external jack on the rear panel provides relay control information to accessory linear amplifiers. Another external jack on the rear of the transceiver will accept ALC

SBE SB-36 OPERATION MANUAL

feed-back information from the linear amplifier to control the power output of the transceiver.

3.0 OPERATION

3.1 OPERATING INSTRUCTIONS

3.1.1

The front and rear panel controls, connectors and indicators used in operating the SB-36 are shown in Figures 3.1 and 3.2 and are described in Table 3.1. The descriptions given in the table are not intended to be operating instructions, but only a reference to determine the function of each stern. The actual transceiver operating procedures will be covered in Sections 4.1 through 4.3.

FIGURE 3.1 SB-36 FRONT VIEW

SBE SB-36 OPERATION MANUAL

3.1 OPERATING INSTRUCTIONS

SBE SB-36 OPERATION MANUAL

Number	Nomenclature	Description
1	RIT Push- On Switch	The receiver incremental (RIT) is activated by depressing the PUSH-ON switch.
2	RIT Lamp	When the RIT PUSH-ON control is activated, the RIT Lamp will be lit.
3	RIT Control	Potentiometer varies the frequency of the VFO Oscillator, +7 kHz in the receive mode.
4	MIC Gain Control	A dual function potentiometer. In USB or LSB modes of operation, the microphone gain regulates the level of audio input from the transceiver microphone. When the mode switch is in the TUNE position, the MIC Gain Control adjusts the RF drive to the final amplifier to a suitable level for tuning the transmitter.
5	Noise Blanker OFF/ON Switch	A two-position switch which controls the receiver noise blanker. Noise blanker does not function when the control is set to "OFF". In the "ON" position the noise blanker will cancel RF noise pulses in the receiver.
6	"kHz" Display	A six nixie tube numeric read-out display is present whenever the transceiver is activated.
7	Upper Band Limit Light	This light will be activated on the following bands whenever the VFO tuning knob is rotated beyond the upper edge of the band: Bands effected: 3.5 - 4.0 MHz 28.5 - 29.0 MHz 29.5 - 30.0 MHz The upper band limit light will not be activated on the remaining bands.
8	Lower Band Light	This light will activate whenever the VFO frequency knob is turned below the lower limit of the band selected by the band selector knob.
9	Meter	The meter indication is dependent upon which "METER" switch position is selected. When receiving, the 0-60 scale indicates receive signal strength regardless of the "METER" switch position. In the IP position the 0-800 milliamp indication on the meter scale should be used. In the ALC position, the bottom portion of the scale marked ALC should be used.
10	AGC Switch	A 3-position slide switch that determines the operation of the automatic gain control (AGC) circuit used in the receive mode. The OFF position opens the AGC output signal path and the remaining two positions complete the signal path. The "FAST" position selects a fast time constant AGC voltage decay and the "SLOW" position selects a slow "HANG" time constant AGC voltage decay.

SBE SB-36 OPERATION MANUAL

- 11 Meter Switching The "METER" switch is used to select the desired parameter to be measured. The three functions of the switch are as follows;
- ALC: When transmitting, place the meter switch in the ALC position. This will help in determining the proper levels of microphone gain and ALC.
- IP: In this position, the meter will indicate plate current in the final amplifier tubes.
- RF: In this position, the meter will indicate the relative RF output power of the transceiver.
- "S" Meter: When receiving, the front panel meter indicates the signal strength of the incoming receive signal irregardless of the position of the meter switch.
- 12 Plate control The Plate Tuning Capacitor resonates the final amplifier Pi-network capacity by varying the input capacity of the Pi-network.
- 13 Load control The Load Control matches the output impedance of the Pi-network to the impedance of the load.
- 14 PHONES Connector The jack connector that permits low impedance head- phone connection. When the head-phone plug is inserted, the speaker is disconnected from the circuit.
- 15 MIC connector The jack connector that permits a low-medium impedance microphone audio output and push-to-talk lines to be connected to the transceiver.
- 16 Mode Switch P. OFF: Main power removed from the transceiver.
TUNE: Tune position is used for transmitter tune-up (USB selected).
USB: For upper sideband operation.
LSB: For lower sideband operation
CW: For CW operation.
- 17 "RF" Gain control A potentiometer which varies the operating bias of the first receiver RF amplifier.
- 18 "AF" Gain Control The potentiometer which is used to set the speaker or headphone audio output to a comfortable listening level.
- 19 VFO Tuning Knob A control that permits tuning of the VFO. Its movement covers a 500 kHz band spread range with approximately 30 kHz per revolution. The exact position in the band, to within +100 Hertz is indicated in the Nixie-tube display.

SBE SB-36 OPERATION MANUAL

20	100 Hz ON/OFF Switch	A two-position switch which controls the 100 Hertz Nixie tube. In the. ON position, the 100 Hertz Nixie tube will be lit. In the OFF position the 100 Hertz Nixie tube will be turned off.
21	"MHz" Band Selector	An 11-position rotary switch used to select the desired frequency band. The "A", "B" or "C" positions will result in no transmitter output unless optional crystals have been installed for non-amateur band use. The remaining positions represent the specific low-end frequency of the selected band. WARNING: Do not change position of the "MHz" band selector when the SB-36 is keyed for transmit condition, as this will result in damage to the equipment, which is not covered by the warranty.
22	Pre-Selector Control	A control used to tune both the receiver RF front end and the transmitter mixer and driver plate circuits.
23	VOX, REC-PTT, Send Switch	A 3-position snap switch which provides for the following functions: In the VOX position, the built-in VOX circuitry in the unit is activated. In the REC-PTT position, the receiver will function until the PUSH-TO-TALK button on the microphone is depressed to activate the transmitter. When placed in the SEND position, the transmitter is automatically keyed. This position should be used for transmitter tune-up.
24	CARR Control	A potentiometer that varies the level of carrier re-insert. This control will adjust the transmitter power output when the unit is in the CW mode of operation.
25	ALC Control	A potentiometer that varies the gain of low level transmit stages in the transceiver to prevent fiat-topping or over driving the final amplifier tubes.
26	BIAS Control	A potentiometer that varies the grid voltage to the final amplifier tubes. This control should be used to set the final amplifier plate current at 50 milliamps idle current.
27	External VFO Jack	A connector for applying the output of an external VFO to the transceiver.
28	KEY Jack	A connector for applying the output of an external paddle key.
29	VOX- SENSE Control	A potentiometer that varies the attenuation of the audio input being applied to the VOX amplifier circuitry. Its function is to adjust the threshold level of speech that is required to key the transmitter.

SBE SB-36 OPERATION MANUAL

30	DELAY Control	Potentiometer that varies the resistance in a time constant circuit on the audio board. When using VOX keying in the transmit mode, its function is to adjust the length of time that the transmitter stays keyed after the operator stops speaking.
31	ANTI- TRIP Control	The potentiometer that varies the attenuation of the speaker audio signal being applied to the ANTI-VOX amplifier circuit input. Its function is to adjust the threshold level of the modulated audio that keeps the SB-36 keyed for a receive condition.
32	Phone Patch "IN JACK"	A connector which will accept phone patch information to excite the transmitter.
33	Phone Patch "OUT JACK"	A connector which provides a 600 ohm audio output for use with phone patch devices.
34	Antenna Jack	The SO-239 connector for connecting the antenna to both transmitter output and receiver input.
35	VFO Jack	A 7-pin socket to be used in conjunction with the external VFO accessory. When the external VFO is not used, the dummy VFO plug should be installed in this socket.
36	Ext. ALC Jack	A connector for accepting external ALC information from a companion linear amplifier to control the transmitter output.
37	RF Jack	This jack provides a low-level output for use with a transverter.
38	REM Jack	This jack provides a remote output to control a companion linear amplifier. The remote output jack provides a ground connection when the transceiver is in the transmit mode.
39	SP Jack	A connector providing an audio output for external speaker use.
40	POWER connector	An 11-pin plug providing primary and secondary power input connections from the accessory power supply.
41	GROUND Connector	A threaded bolt with wing nut provided for earth ground connections.

4.0 OPERATING PROCEDURE

WARNING:

Under no circumstances should operation of the SB-36 be attempted without a proper antenna or dummy load of specific power handling capability. Please read Sections 4.1 through 4.3 fully before attempting to operate the SB-36 Transceiver.

4.1 RECEIVER OPERATION

- 4.1.1 Rotate the mode selector switch clockwise from the P. OFF position to the desired operating mode. Allow approximately two minutes for warm-up.
- 4.1.2 Rotate the BAND selector switch to the desired band.
- 4.1.3 Advance the RF gain control to the full clockwise position.
- 4.1.4 Rotate the AF Gain Control to its mid-range position.
- 4.1.5 Rotate the VFO Tuning Knob to the desired operating frequency.
- 4.1.6 Adjust the PRE-SELECT control until maximum back ground noise/interfering signal is obtained.
- 4.1.7 Place the noise blanker and AGC controls in desired operating position.
- 4.1.8 Adjust the RF and AF Gain Controls for a suitable listening level.
- 4.1.9 Fine tuning of the incoming signal may be accomplished by either rotating the main VFO tuning knob or by use of the RIT control.
NOTE: If the RIT control is used, the Nixie tube read-out will indicate the exact frequency of the incoming signal. When the SB-36 is placed in the transmit mode, the Nixie tube read-out will revert back to the frequency selected when the RIT control was off.

4.2 TRANSMIT TUNING PROCEDURE

- 4.2.1 For transmitter tune up, place the controls as outlined in Steps 4.1.1 through 4.1.9.
- 4.2.2 Position the plate tuning control to correspond to the band on which operation is desired.
- 4.2.3 Rotate the LOAD control to its maximum counter clockwise position.
- 4.2.4 Place the meter switch in the IP position.
- 4.2.5 Rotate the MIC control to its maximum counter clockwise position.

SBE SB-36 OPERATION MANUAL

- 4.2.6 Place the MODE switch to the TUNE position.
- 4.2.7 Place the VOX/REC-PTT/SEND switch to the SEND position.
- 4.2.8 Advance the MIG Gain Control slightly while tuning the PRESELECT control for maximum indication on the meter.
CAUTION: Do not exceed 300-400 mA of plate current until final amplifier tuning and load control have been properly adjusted.
- 4.2.9 Rotate the PLATE tuning control for minimum or dip indication on the IP reading. When dip is obtained, advance the MIC Gain Control to produce a 300-400 mA indication on the meter.
- 4.2.10 Place the METER switch in the RF position.
- 4.2.11 Rotate the LOAD control for maximum meter indication. Use the MIC Gain Control as necessary to keep the maximum meter indication below 600-700 mA indication on the meter. Tune both the PLATE Tuning Control and LOAD control to obtain Maximum indication on the meter.
- 4.2.12 Place the VOX/REC-PTT /SEND switch to the REC-PTT position. Rotate the MODE switch to either Upper or Lower Sideband position.
- 4.2.13 Place the METER switch in the IP position. Press the push-to-talk button on the microphone and, while speaking into the microphone in a normal tone of voice, adjust the microphone gain control for an average IP indication of 350-400 milliamps.
- 4.2.14 Place the METER switch in the ALC position. The meter will indicate nearly full scale deflection. Adjust the ALC potentiometer (located on the rear panel of the radio) so that on voice peaks, a slightly downward indication is obtained on the meter. This will indicate that the ALC is functioning properly.
- 4.2.15 The METER switch may now be placed in the RF position to indicate relative transmitter power output.

4. 3 CW OPERATION

- 4.3.1 Perform the steps outlined in sterns 4.2.1 through 4.2.15.
- 4.3.2 Place the VOX/REC-PTT/SEND switch to the VOX position.
- 4.3.3 Rotate the MODE switch to the CW position.
- 4.3.4 Connect a key to the KEY jack located on the rear panel of the transceiver.
- 4.3.5 Depress the key and adjust the VOX SENSE CONTROL on the rear panel so that the transmitter keys on. It may be also necessary to adjust the ANTI-VOX potentiometer on the rear panel of the unit.

SBE SB-36 OPERATION MANUAL

- 4.3.6 With the key depressed, adjust the CARR potentiometer (located on the rear panel of the unit) so the transmitter power output does not exceed 200 watts on 15 through 80 meters or 150 watts on 10 meters.

5. 0 THEORY OF OPERATION

5. 1 GENERAL

5.1.1

Figure 5.1 shows the basic transmitter receive signal paths and the printed circuit boards associated with each. The SB-36 Transceiver is comprised of a power amplifier assembly, accessory power supply, and one each of the following circuit boards:

Drive RF/Pre-Mixer and Oscillator Board, Counter Unit, VFO Oscillator, carrier Oscillator Board, Double Sideband Amplifier/Crystal Filter/Noise Blanker Board, Microphone Amplifier and Side Tone Oscillator Board, Receiver IF Amplifier and AGC Amplifier Board, 20 volt Regulator Board, AF Power Amplifier Board, and VOX and ANTI-TRIP Board.

The printed circuit board relationship in respect to transmit or receive signal paths is shown in Figure 5.1. In the transmit mode, the signal is routed from the microphone through the MIC AMP Board, Double Sideband AMP/Crystal Filter Board, Driver RF/Pre-Mix and Oscillator Board, and PA Assembly. A more detailed explanation of the transmit signal path is covered in paragraph 5.2. In the receive mode the signal is routed from the antenna connector through the PA assembly, Driver RF/Pre-Mix and Oscillator Board, Double Sideband Amplifier / Crystal Filter Board, Receiver IF Amplifier and AGC Amplifier Board, Audio PC Board, to the external speaker jack. A more detailed explanation of the receiver signal path is covered in paragraph 5. 3.

Frequencies generated by the BFO (9 MHz) Board are routed to the double sideband amplifier and noise blanker board and from there are routed to the driver RF/Pre-Mixer and Oscillator Board. Frequencies generated by the VFO are routed to the Driver RF/Pre-Mixer and Oscillator Board. The Theory of Operation section employs the use of more detailed block diagram's than Figure 5.1. Complete schematics are also contained in Section 7 and should be used in conjunction with the description of the transmitter and receiver circuitry contained in the following paragraphs.

5. 2 TRANSMITTER CIRCUITRY

5.2.1 Transmitter Signal Path

Stage-by-Stage transmit signal path block diagrams is shown in Figure 5.1. Unless otherwise indicated in the following explanation, it is assumed that the SB-36 is operating in the Single Sideband Mode.

Audio signals from the microphone connector or phone patch input jack are routed to TR-1 located on the Microphone Amplifier and Side Tone Oscillator Board. The audio signal is amplified by transistor TR-1 and then routed to the base of TR-2. The amplified output of transistor TR-2 is routed through transistor TR-3, which is operating as an emitter follower. The output of transistor TR-3 is routed through variable resistor VR-1 (Microphone Gain Potentiometer) to the base of transistor TR-4.

The signal from transistor TR-4 is then routed to one input of the balanced modulator. The balanced modulator is comprised of transformer T-9 and Diodes D-1 through D-4. The second input of the balanced modulator is a 9.0 MHz carrier signal. The 9.0 MHz carrier signal originates in the carrier oscillator board and is applied to the balanced modulator by variable resistor VR-5. The balanced modulator mixes the 9.0 MHz carrier with the audio signal to produce a resultant 9.0 MHz double sideband signal with a carrier suppressed approximately 40 dB. Third and higher order modulation products are also suppressed approximately 30 dB below each sideband. The balanced modulator output is routed to the input of the upper or lower sideband crystal filter.

The output from the crystal filter is routed by transformer T-10 to the input of transistor TR-7. The output of transistor TR-7 is coupled by transformer T-11 to the grid of mixer tube V-1.

A second input to the grid of mixer tube V-1 is derived by mixing the output of the HFO transistor TR-10 with the output of VFO oscillator. The HFO oscillator output and the VFO oscillator output are combined in mixer transistor TR-11. The resultant frequency is transformer coupled to the grid of mixer tube V-1.

The desired transmit frequency is obtained by mixing the 9.0 MHz sideband output of transistor TR-7 with the HFO/VFO product produced

SBE SB-36 OPERATION MANUAL

by transistor TR-11. The output of mixer tube V-1 is coupled to the grid of V-2, the driver tube. Output of tube V-2 is capacitively coupled to the input of the PA tubes, V-5 and V-6.

Normal signal level at the PA tube input is 50 volts peak-to-peak. The signal passes through the plate tuning circuits and metering circuits to the main antenna connector located on the rear panel.

The RF power output at the connector is a nominal 300 watts on 15-80 meters and 200 watts on 10 meters.

5.2.2 Automatic Level Control

Automatic Level Control (ALC) is employed to control the amount of RF drive to the power amplifier tubes. The ALC method utilized by the SB-36 is shown in simplified diagrams Figure 5.2. When the signal present on the grid of the final amplifier tubes exceeds the grid bias of the tube, Diodes D-29 and D-30 conduct.

This conduction will establish a reference voltage across the ALC potentiometer.

The voltage on the center terminal of the ALC potentiometer is fed back to the gate of transistor TR-7. This voltage is used to control the gain of TR-7 to prevent flat-topping of the transmitter signal. This system of ALC allows a high average level of modulation without a corresponding increase in distortion products.

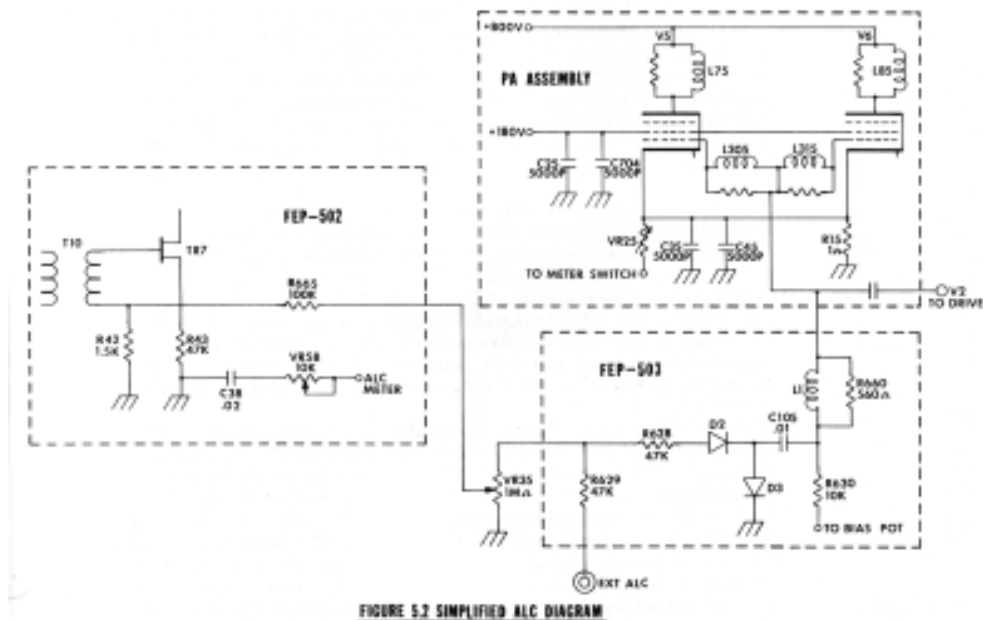

5. 3 RECEIVER CIRCUITRY

5.3.1 Receiver Signal Path

RF signals from the antenna connector pass through the antenna relay and trap coil L-24 to the grid of 1st, the first RF amplifier. Trap Coil L-24 minimizes spurious receiver response caused by signals which fall within the 9 MHz IF frequency range. The amplified signal from V-4 is coupled to the grid of V-3, the receiver mixer tube. Signals present in V-3 consist of the incoming RF signal and the VFO/HFO mixture from TR-11.

The output of V-3 is a 9 MHz IF signal which is coupled to either the upper or lower crystal filter through transformer T-9A. Output of the crystal filter is then coupled to TR-7, TR-28, TR-27 and TR-i6 which are all 9 MHz IF amplifiers. The output of TR-26 is coupled to both the receiver balance protector circuit and the receiver AGG circuit.

The 9 MHz output of the TR-26 is also coupled to Diodes D-18 through D-21, the receiver balanced detector. The audio output of the balanced detector is then applied to VR-509, the AF gain control. The audio signal front the wiper of VR-9 is routed to the audio printed circuit board where it is coupled to the base of TR-25. The output of TR-25 drives TR-22 and TR-23 the AF power amplifier transistors.

The resultant audio output from TR-22 and TR-23 is applied to the earphone jack, speaker jack and telephone patch out jack.

5.3.2 Noise Blanker

The noise blanker circuit utilized in the SB-36 Transceiver receives noise information directly from the antenna connector. The incoming noise signal is amplified by integrated circuit TR-8 detected by Diodes D-205 and D-206 and coupled to the gate of TR-7 to inhibit the received signal from passing through TR-7 during the presence of strong RF noise pulses.

5.3.3 Automatic Gain Control

Automatic Gain Control (AGC) is employed in the SB-36 Transceiver to maintain a constant receive signal level passing through the front end and IF Amplifier Board. The AGC circuitry can be completely disabled by switching the front panel "AGC" control to the "OFF" position.

SBE SB-36 OPERATION MANUAL

AGC circuit is located on the IF amplifier printed circuit board. Its controlling effects can be overridden by setting of the front panel "RF Gain" potentiometer VR-601. The AGC circuit provides two outputs with an increasing RF input signal level. First, the AGC voltage is applied to the control grid of V-4 the RF amplifier tube. Second, the AGC voltage is applied to the gate of TR-28 on the IF amplifier board.

With the front panel "AGC" switch set to the "OFF" position, the front panel "RF Gain" potentiometer VR-601 still can control the gain in V-4, the first RF amplifier tube. A negative potential from the wiper of VR-601 is applied to the control grid of V-4. The amount of negative potential selected by the wiper of VR-601 determines the gain of V-4.

The AGC circuit is comprised of Diodes D-22, D-23 and transistor TR-29. Under a no-RF signal input condition, transistor TR-29 does not conduct. With an RF signal present, transistor TR-29 is driven into conduction. The output of transistor TR-29 is applied to both the grid of V-4 and the gate of TR-28.

5.3.4 VOX Keying

When operating in the VOX mode of operation, transmitter switching is accomplished automatically by the "VOX" circuitry. Microphone audio signals are routed from TR-3 to VR-501, the VOX SENSE potentiometer. The audio signal from the wiper of VR-501 is coupled to the base of transistor TR-13. The audio output of TR-13 is provided additional amplification by transistor TR-13A. The output of transistor TR-13A is coupled to TR-14 and TR-15 which are Darlington connected transistors. When transistors TR-14 and TR-15 are switch "ON" by the audio signal from TR-13A, a ground return is provided for relay RF-I which then places the transceiver in the transmit mode of operation. The rear panel "DELAY" potentiometer VR-502 is used to vary the RC time constant in the emitter of transistor TR-13A. The "DELAY" circuit is used to prevent the transmitter from unkeying between spoken syllables of a lower speech rate. Therefore, it is desirable to keep the transmitter keyed a few milliseconds longer than is normal. This is accomplished by increasing the resistance setting of the "DELAY" potentiometer VR-502.

Transistor TR-13 provides ANTI-TRIP or ANTI-VOX information to the VOX circuitry. This information will prevent audio from the transmitter

SBE SB-36 OPERATION MANUAL

speaker (which is also heard by the microphone) from keying the transceiver. The output of transistor TR-13A, a DC potential derived from Diodes D-14 and D-15, is applied to the base of the Darlington pair transistors TR-14 and TR-15.

When the VOX SENSE and ANTI- TRIP controls are properly set, audio from the transceiver speaker, which is also picked up by the transceivers microphone, will produce opposite voltages at the base of transistor TR-14 which will cancel each other so that the stage remains cut off. Any speech then applied to the microphone will cause the stage to conduct.

5.3.5 Frequency Mixing Network

The basic concept of the frequency mixing employed in the SB-36 Transceivers is show in Table 5.1.

Table 5.1 shows the relationship of the 9 MHz carrier oscillator, VFO and HFO outputs for the various bands used in the SB-36 Transceiver.

TABLE 5.1 SB-36 FREQUENCY CHART

Band	Mode	Output Frequency	BFO Freq.	VFO Freq.	HFO Freq.
(MHz)		(kHz)	(kHz)	(kHz)	(kHz)
3.5	CW	3500 - 4000	9000	5000 - 5500	---
7.0	CW	7000 - 7500	9000	5000 - 5500	21500
14.0	CW	14000 - 14500	9000	5000 - 5500	28500
21.0	CW	21000 - 21500	9000	5000 - 5500	35500
28.0	CW	28000 - 28500	9000	5000 - 5500	42500
28.5	CW	28500 - 29000	9000	5000 - 5500	43000
29.0	CW	29000 - 29500	9000	5000 - 5500	43500
29.5	CW	29500 - 30000	9000	5000 - 5500	44000

5.3.5.1 Carrier Oscillator

The Carrier Oscillator is a crystal controlled oscillator operating at 9.000 MHz. The output of the 9 MHz oscillator transistor TR-17 is coupled to transmitter buffer transistor TR-19 and receiver buffer transistor TR-20. The output of the transmitter buffer transistor TR-19 is applied via the mode switch to the wiper arm of BR-5 located in the transmit balanced modulator circuitry.

SBE SB-36 OPERATION MANUAL

Output of the receiver buffer transistor TR-20 is coupled to the wiper arm of potentiometer VR-12 located in the receiver balanced detector circuit.

5.3.5.2 VFO Oscillator

The VFO Oscillator uses a field effect transistor TR-3^(*) as the oscillator and TR-31 as the buffer transistor. The output of TR-31 is connected to transistors TR-32 and TR-48.

(* Typo. Should be TR-30.)

The output of transistor TR-32, VFO information, is applied to the counter circuitry in the SB-36 Transceiver.

The output of transistor TR-48 is VFO injection which is applied to the emitter of mixer transistor TR-11.

The VFO operates on a frequency of 5.0 to 5.5 MHz.

Diode D-211 is a variable capacitance Diode connected in parallel with C-120. Diode D-211 is switched into the circuit by the RIT selector switch and the main relay contacts to shift the VFO frequency when capacitor VR-602 is varied from one extreme to the other.

<Figure 5.43 Block Diagram of Counter Unit >

5.3.5.3 High Frequency Oscillator

The SB-36 has seven high frequency crystals used in the HFO oscillator circuitry. The relationship between the transceiver operating frequency and the HFO crystal frequency is shown on Table 5. 2.

HFO oscillator transistor TR-10 is crystal controlled by one of the seven crystals selected by the band switch. Output of HFO transistor TR-10 is coupled to the base of pre-mixed transistor TR-11. Output of pre-mixed transistor TR-11 is coupled to either the grid of the transmit mixer tube V-1, or the cathode of the receiver mixer tube V-3.

SBE SB-36 OPERATION MANUAL

5.3.5.4 Side Tone Oscillator

Transistor TR-5 is a phase shift side-tone oscillator which operates when the mode switch is in either the CW or tune position. Frequency with phase shift oscillator is approximately 1000 kHz.

The output of TR-5 is fed to the transmitter microphone audio circuit when the mode switch is in the TUNE position to provide a signal which will allow tune-up of the transmitter.

In the CW mode of operation, output from the side tone oscillator is fed to the VOX circuitry and to the receiver audio amplifier.

The signal to the VOX circuitry is used to drive the VOX amplifier transistor, TR-13.

The side tone audio output supplied to the receiver audio amplifier is used for operator monitoring when in CW operation.

5.3.6 Counter

The basic concept of the frequency counter circuit employed by the SB-36 Transceiver is shown in Figure 5.3. To obtain a "RESET" and "READ" command signal, the master clock input signal is reduced in frequency by the clock divider chain. The "RESET" Command signal instructs the RF counter chain when to start and when to stop processing the RF input count-down.

The "READ" Command signal instructs the input count gate when to pass and when not to pass the RF input to the RF counter chain.

The "READ" Command also causes the "READ" gate to turn on or off the Nixie display tubes. The code converter circuit transposes the logic output of the RF counter chain into driving voltages that cause the appropriate numerals of each Nixie tube to illuminate.

The operating sequence of events for the frequency counter circuit is as follows:

- A. Momentary reset pulse clears the RF counter outputs causing the output state to return to the starting count of zero.
- B. The "READ" Command turns off the Nixie tubes for the duration of the read-in period and also enables the input count gate to pass the RF input to the RF counter.
- C. The RF counter chain processes the RF input frequency count

SBE SB-36 OPERATION MANUAL

down.

- D. After a specific period of time, the "READ" Command switches to the read-out potential. The operation of the input count is inhibited. With no more inputs being applied to the RF counter chain, the last count produced by each divider circuit (in the RF counter chain) is retained. Their output stages are, in effect, a form of data storage.
- E. When the "READ" Command is switched to the READ-OUT potential, it also causes the "READ" gate to turn on the Nixie tubes. The converted output states of the RF counter chain is displayed for the duration of the READ-OUT potential.
- F. The reset pulse reoccurs causing a recycling of events discussed in paragraph 5.3.6, items A through E.

The previous sequence of events occurs at a rate faster than the human eye can follow. Only the frequency display of the Nixie tubes is perceived.

Operating in conjunction with the counter circuit in the SB-36 Transceiver are upper and lower band limit lights. The band limit lights provide a visual indication to the operator when the transceiver VFO is operating outside of a normal band. Table 5.2 shows the relationship between the various bands in the SB-36 Transceiver and functions of the band edge limit lights.

TABLE 5.2 UPPER/LOWER RANGE LIMIT LIGHTS

Band	Upper Lamp	Lower Lamp
80 m	ON	ON
40 m	OFF	ON
20 m	OFF	ON
15 m	OFF	ON
10 m (28.0 - 28.5 MHz)	OFF	ON
10 m (28.9 - 29.0 MHz) *1	ON	ON
10 m (29.0 - 29.5 MHz)	OFF	ON
10 m (29.5 - 30.0 MHz)	ON	ON

(*1: Typo: Should be 28.5 -29.0MHz.)

5.3.7 Power Supply

The DC operating voltage for the SB-36 Transceiver are generated by the companion AC power supply. The power supply consists of a printed circuit board and miscellaneous electrical parts mounted in the

SBE SB-36 OPERATION MANUAL

AC power supply chassis. A block diagrams of the power supply circuit is shown in Figure 5.4.

Table 5.3 shows pin connections for the power supply interconnect cable on the SB-36 Transceiver and the various voltages and currents required at each pin.

TABLE 5.3 POWER SUPPLY REQUIREMENTS

Pin	Voltage	Current
1	Power Supply to Transceiver Ground	---
2	100 VAC	---
3	+12 VDC	700 mA
4	+30 VDC	150 mA
5	12 VAC	Filaments
6	OFF/ON Switch	---
7	OFF/ON Switch	---
8	-180 VDC	Bias
9	+180 VDC	80 mA
10	+400 VDC	70 mA
11	+800 VDC	650 mA

<Figure 5.4 Power Supply Block Diagram>

6. 0 MAINTENANCE

6. 1 INTRODUCTION

This section contains general information for use in preventative or corrective maintenance, troubleshooting, component replacement and troubleshooting aids. This section is not intended to contain information necessary for major repair of the SB-36, however, information contained herein may be useful in minor corrective maintenance.

6.2 PREVENTATIVE MAINTENANCE

6.2.1 General

Preventative maintenance consists of cleaning, visual inspection, lubrication, etc. Preventative maintenance performed on a regular basis may prevent breakdown and improve reliability.

The SB-36 Transceiver should be cleaned as often as operating conditions require. Accumulation of dirt in the instrument can cause overheating and component breakdown. Dirt on component acts as an insulating blanket and prevents efficient heat dissipation. It also provides an electrical conduction path.

CAUTION: Avoid the use of chemical cleaning agents which may damage the plastic used in various components in the transceiver.

6.2.2 Cover Removal

Remove the 20 Phillips Head Screws securing the top and bottom cover to the transceiver. The top cover may then be removed and the transceiver may be lifted free of the bottom cover.

6.2.3 Cleaning

- A. Exterior. Loose dust accumulated on the outside cover of the SB-36 Transceiver and Power Supply can be removed with a soft cloth or squall paint brush. A paint brush is particularly useful for dislodging dirt on and around front panel controls.
- B. Interior. Dust in the interior of the transceiver should be removed occasionally due to its electrical conductivity under high humidity conditions. The best way to clean the interior is to blow out the accumulated dust with dry, low velocity air. A

SBE SB-36 OPERATION MANUAL

cotton tipped applicator is useful for cleaning in narrow spaces and circuit boards.

The high voltage circuits, particularly located in the PA assembly, should receive special attention. Excessive dirt in these areas may cause high voltage arcing and result in improper operation of the transceiver.

6.2.4 Lubrication

The reliability of potentiometers, rotary switches and other moving parts can be maintained if they are kept properly lubricated. Use a cleaning type lubricant on switch contacts. Lubricate switch detentes with a heavier grease. Potentiometers which are not permanently sealed should be lubricated with a lubricant which does not effect electrical characteristics. A potentiometer lubricant can also be used on shaft bushings. Do not over lubricate.

6.3 TROUBLESHOOTING

6.3.1 Troubleshooting Techniques

These troubleshooting procedures are arranged in an order which checks the simplest possibility before proceeding. The first checks assure proper operation and connection. If the trouble is not located by these checks, the remaining steps aid in locating the defective component. When the defective component is located it should be replaced.

A. Check switch and control settings.

Incorrect settings can indicate a trouble that does not exist. If there is any question about the correct function or operation of any control, see the Operating Instructions section of this manual.

B. Check associated equipment.

Before proceeding with troubleshooting, check that the equipment used with the transceiver is operating correctly. Check that the interconnecting cables are not defective. Also, check the power supply.

C. Isolate trouble.

Investigate the extent of the symptoms by monitoring the front panel and "kHz" display while operating in different switch and control settings

SBE SB-36 OPERATION MANUAL

and various modes. Perform a visual check for damaged wires, electrical and mechanical parts, and printed circuit boards. Check for loose interconnection between printed circuit boards.

D. Check individual parts.

The following procedure describes the method of checking individual parts. Parts which are soldered in place are best checked by disconnecting one end. This isolates the measurements from the effects of surrounding circuitry.

(1) Transistors and Integrated circuits.

The best check of operation is actual performance under operating conditions. If a part is suspected of being defective, it can best be checked by substituting a new part or one which has been checked previously. However, be sure that circuit conditions are not such that a replacement might also be damaged.

(2) Diodes.

A Diode can be checked for open or shorted conditions by measuring the resistance between terminals. With an ohm meter scale having an internal source of between 800 millivolts and 3 volts, the resistance should be very high in one direction and very low when the leads are reversed.

(3) Resistors.

Check the resistors with an ohm meter. check the electrical parts list for the tolerance of the resistor used in the instrument. Resistors do not nominally need to be replaced unless the measured value varies widely from the specified value.

(4) Inductors.

Check for open inductors by checking continuity with an ohm meter. Shorted or partially shorted inductors can easily be found by checking the wave form response when high frequency signals are passed through the circuit. Partially shorting often reduces high frequency response (roll-off).

(5) Capacitors.

A leaky or shorted capacitor can best be detected by checking resistance with an ohm meter on high scale. Do not exceed the voltage reading of the capacitor. The resistance reading should be high after initial charge of the capacitor. An open capacitor' can best be detected

SBE SB-36 OPERATION MANUAL

with a capacitance meter or by checking whether the capacitor passes AC signals.

6.3.2 Voltage Table and Injection Points

Table 6.1 contains voltage measurements and injection levels to be used as an aid in isolating a defective stage or component.

TABLE 6. 1 VOLTAGE TABLE AND SIGNAL INJECTION LEVELS

Table 6.1.1 Receiver DC Voltages - No Signal Input - USB Mode

V4 6BZ6 (R.F. Amplifier)	Pin 1	0.08 V		
	Pin 2	1.0 V		
	Pin 5	320 V		
	Pin 6	102 V		
	Pin 7	1.0 V		
V3 6AW8 (Receiver Mixer)	Pin 6	1.95 V		
	Pin 7	0.1 V		
	Pin 8	50 V		
	Pin 9	320 V		
	Gate	Source	Drain	
TR-7 (IF Amplifier)	0.01V	0.47V	20V	
TR-28 (IF Amplifier)	0.15V	1.1V	20V	
	Base	Emitter	Collector	
TR-27 (IF Amplifier)	7.2V	6.6V	18V	
TR-26 (IF Amplifier)	6.8V	6.2V	14.5V	
TR-29 (AGC Amplifier)	Base	Emitter	Collector	
AFC OFF	-8V	-8V	0	
AGC ON - No Input	-8V	-8V	0	
AGC ON - 10 μ V Input	-7.5V	-8V	-4V	
AGC ON - 1000 μ V Input	-7.4V	-8V	-5.6V	

SBE SB-36 OPERATION MANUAL

Table 6.1.2 Audio Amplifier DC Voltages

	Base	Emitter	Collector
TR-25	7.2V	7.8V	0.6V
TR-24	0.6V	0V	8.8V
TR-23	8.8V	9.4V	0V
TR-22	10.2V	9.7V	19.5V

Table 6.1.3 20V Regulator DC Voltages

	Base	Emitter	Collector
TR-45	22V	21.5V	27.4V
TR-46	21.7V	21.0V	28V
TR-47	13.8V	13.2V	22V

Table 6.1.4 Transmitter Tube DC Voltages - "Send" Mode – No Drive

V1 6EJ7 (Transmitter Mixer)	Pin 1-3	5.2V
	Pin 2	0V
	Pin 7	310V
	Pin 8	300V
V2 6BQ5 (Transmitter Driver)	Pin 2	0.04V
	Pin 3	9.8V
	Pin 7	350V
	Pin 9	315V
V5 & V6 (PA Tubes)	Pin 5-9	-57V
	Pin 3-11	190V
	Pin 4-10	0V
	Pin 2	0.04V
	Plate Caps	780V

TABLE MISSING

SBE SB-36 OPERATION MANUAL

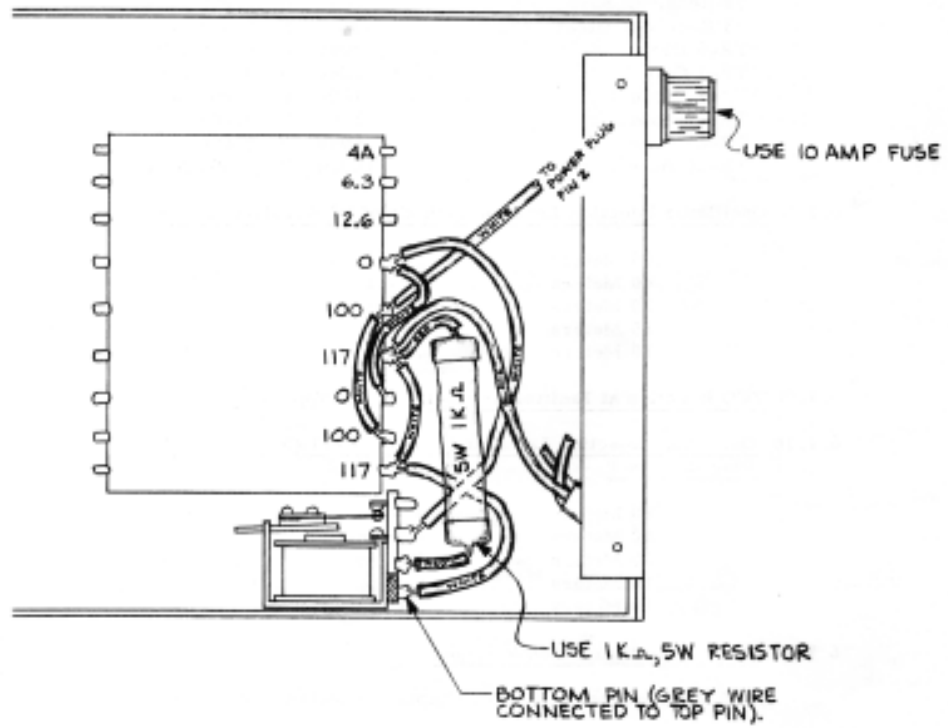

FOR 117V OPERATION

FIGURE 6.2

SBE SB-36 OPERATION MANUAL

SERVICE MAINTENANCE

Should your SB-36 fail to perform as stated in this manual, it is recommended that SBE be contacted in writing. SBE will either authorize return of the unit to the factory or refer you to an authorized SBE repair agency in your area. **DO NOT SHIP EQUIPMENT WITHOUT PRIOR WRITTEN AUTHORIZATION FROM SBE.**

Your letter to SBE must include the following:

1. Model number and serial number of equipment.
2. Date of purchase of equipment.
3. Nature of trouble.
4. Cause of trouble if known.
5. Name of distributor from whom equipment was purchased.
6. Your return address.
7. Method of shipment by which the equipment should be returned.

In addition, include any information that you feel will be helpful in locating or correcting the problems.

PARTS ORDERING INFORMATION

When ordering replacement parts, you should direct your order to an SBE distributor or SBE, Replacement Parts Department, 220 Airport Boulevard, Watsonville, California 95076. Please furnish the following information.

1. Quantity required.
2. SBE part number and description.
3. Item or symbol number obtained from parts list, schematic, component location drawings.
4. SBE model number and serial number.

Unless specified, SBE will determine the best method of shipment for the parts involved.

All parts will be sent C.O.D. unless ordered through an SBE distributor.

NOTE: Minimum parts billing is \$2.50.

SBE SB-36 OPERATION MANUAL

FEP-501: MICROPHONE AMPLIFIER SIDE TONE OSCILLATOR PC BOARD

SYM	PART NUMBER	DESCRIPTION
C1	8000-00010-009	Capacitor, Fixed, Electrolytic, 47 μ F, 25V
C2	8000-00010-003	Capacitor, Fixed, Ceramic, 330pF, 50V
C3	8000-00010-007	Capacitor, Fixed, Electrolytic, 10 μ F, 16v
C4	8000-00010-007	Capacitor, Fixed, Electrolytic, 10 μ F, 16v
C5	8000-00010-007	Capacitor, Fixed, Electrolytic, 10 μ F, 16v
C6	8000-00010-004	Capacitor, Fixed, Ceramic, 0.01 μ F, 50V
C7	8000-00010-007	Capacitor, Fixed, Electrolytic, 10 μ F, 16v
C8	8000-00010-005	Capacitor, Fixed, Ceramic, 0.1 μ F, 50V
C9	8000-00010-007	Capacitor, Fixed, Electrolytic, 10 μ F, 16v
C10	8000-00010-008	Capacitor, Fixed, Electrolytic, 22 μ F, 25v
C11	8000-00010-008	Capacitor, Fixed, Electrolytic, 22 μ F, 25V
C12	8000-00010-007	Capacitor, Fixed, Electrolytic, 10 μ F, 16v
C13	8000-00010-007	Capacitor, Fixed, Electrolytic, 10 μ F, 16v
C14	8000-00010-010	Capacitor, Fixed, Ceramic, 0.02 μ F, 50V
C15	8000-00010-005	Capacitor, Fixed, Ceramic, 0.1 μ F, 50V
C16	8000-00010-007	Capacitor, Fixed, Electrolytic, 10 μ F, 16v
C17	8000-00010-006	Capacitor, Fixed, Mylar, 0.01 μ F, 50V
C18	8000-00010-006	Capacitor, Fixed, Mylar, 0.01 μ F, 50V
C19	8000-00010-005	Capacitor, Fixed, Ceramic, 0.1 μ F, 50V
RL4	8000-00010-015	Relay, 12 VDC
TR1	8000-00010-002	Transistor, 2SC458
TR2	8000-00010-002	Transistor, 2SC458
TR3	8000-00010-002	Transistor, 2SC458
TR4	8000-00010-001	Transistor, 2SC367
TR5	8000-00010-002	Transistor, 2SC458
VR2	8000-00010-011	Resistor, Variable, 10k Ω
VR3	8000-00010-012	Resistor, Variable, 100k Ω

SBE SB-36 OPERATION MANUAL

FEP-502: DSB SSB AMPLIFIER AND NOISE BLANKER PC BOARD

SYM	PART NUMBER	DESCRIPTION
C22	8000-00010-004	Capacitor, Fixed, Ceramic, 0.01 μ F, 50V
C23	8000-00010-036	Capacitor, Fixed, Ceramic, 1000pF, 50V
C24	8000-00010-032	Capacitor, Fixed, Styrol, 22pF, 50V
C25	8000-00010-010	Capacitor, Fixed, Ceramic, 0.02 μ F, 50V
C26	8000-00010-010	Capacitor, Fixed, Ceramic, 0.02 μ F, 50V
C26A	8000-00010-005	Capacitor, Fixed, Ceramic, 0.1 μ F, 50V
C26B	8000-00010-005	Capacitor, Fixed, Ceramic, 0.1 μ F, 50V
C26C	8000-00010-004	Capacitor, Fixed, Ceramic, 0.01 μ F, 50V
C26D	8000-00010-034	Capacitor, Fixed, Electrolytic, 10uf, 25V
C26E	8000-00010-004	Capacitor, Fixed, Ceramic, 0.01 μ F, 50V
C26F	8000-00010-004	Capacitor, Fixed, Ceramic, 0.01 μ F, 50V
C26G	8000-00010-004	Capacitor, Fixed, Ceramic, 0.01 μ F, 50V
C26H	8000-00010-004	Capacitor, Fixed, Ceramic, 0.01 μ F, 50V
C26I	8000-00010-004	Capacitor, Fixed, Ceramic, 0.01 μ F, 50V
C26J	8000-00010-004	Capacitor, Fixed, Ceramic, 0.01 μ F, 50V
C26L	8000-00010-004	Capacitor, Fixed, Ceramic, 0.01 μ F, 50V
C26M	8000-00010-004	Capacitor, Fixed, Ceramic, 0.01 μ F, 50V
C26N	8000-00010-004	Capacitor, Fixed, Ceramic, 0.01 μ F, 50V
C26P	8000-00010-004	Capacitor, Fixed, Ceramic, 0.01 μ F, 50V
C26Q	8000-00010-004	Capacitor, Fixed, Ceramic, 0.01 μ F, 50V
C37	8000-00010-010	Capacitor, Fixed, Ceramic, 0.02 μ F, 50V
C38	8000-00010-010	Capacitor, Fixed, Ceramic, 0.02 μ F, 50V
C601	8000-00010-005	Capacitor, Fixed, Ceramic, 0.1 μ F, 50V
C602	8000-00010-028	Capacitor, Fixed, Ceramic, 5pF, 50V
C602A	8000-00010-004	Capacitor, Fixed, Ceramic, 0.01 μ F, 50V
C604	8000-00010-028	Capacitor, Fixed, Ceramic, 5pF, 50V
C605	8000-00010-004	Capacitor, Fixed, Ceramic, 0.01 μ F, 50V
C608	8000-00010-034	Capacitor, Fixed, Electrolytic, 10 μ F, 25V
C609	8000-00010-005	Capacitor, Fixed, Ceramic, 0.1 μ F, 50V
C610	8000-00010-004	Capacitor, Fixed, Ceramic, 0.01 μ F, 50V
C611	8000-00010-005	Capacitor, Fixed, Ceramic, 0.1 μ F, 50V
C612	8000-00010-004	Capacitor, Fixed, Ceramic, 0.01 μ F, 50V
C614	8000-00010-005	Capacitor, Fixed, Ceramic, 0.1 μ F, 50V
C624	8000-00010-005	Capacitor, Fixed, Ceramic, 0.1 μ F, 50V
C632	8000-00010-030	Capacitor, Fixed, Ceramic, 100pF, 50V
C671	8000-00010-036	Capacitor, Fixed, Ceramic, 1000pF, 50V
D1	8000-00010-020	Diode, 1N60
D2	8000-00010-020	Diode, 1N60
D3	8000-00010-020	Diode, 1N60
D4	8000-00010-020	Diode, 1N60

SBE SB-36 OPERATION MANUAL

SYM	PART NUMBER	DESCRIPTION
D5	8000-00010-020	Diode, 1N60
D6	8000-00010-020	Diode, 1N60
D7	8000-00010-020	Diode, 1N60
D8	8000-00010-020	Diode, 1N60
D9	8000-00010-020	Diode, 1N60
D10	8000-00010-020	Diode, 1N60
D205	8000-00010-020	Diode, 1N60
D206	8000-00010-020	Diode, 1N60
L601	8000-00010-039	Choke, RFC
L602	8000-00010-039	Choke, RFC
T9	8000-00010-038	Transformer, 9 MHz
T9A	8000-00010-038	Transformer, 9 MHz
T10	8000-00010-038	Transformer, 9 MHz
T11	8000-00010-038	Transformer, 9 MHz
T12	8000-00010-038	Transformer, 9 MHz
TR6	8000-00010-018	Transistor, 2SK30
TR7	8000-00010-017	Transistor, 2SK30
TR8	4804-00003	Integrated Circuit, μ A-703
TR9	8000-00010-018	Transistor, 2SK30
TR50	8000-00010-002	Transistor, 2SC458
TR51	8000-00010-018	Transistor, 2SK30
TR52	8000-00010-019	Transistor, 2SA495
TR53	8000-00010-019	Transistor, 2SA495
VC1	8000-00010-037	Capacitor, Variable, 30pF
VR5	8000-00010-023	Resistor, Variable, 500 Ω
VR5N	8000-00010-027	Resistor, Variable, 100K Ω
	8000-00010-040	Filter, Crystal, 9 MHz, Upper
	8000-00010-041	Filter, Crystal, 9 MHz, Lower
	8000-00010-046	Filter, Crystal, 9 MHz, CW
	8000-00010-042	Socket for RL1
	8000-00010-242	Filter, Crystal, CW

SBE SB-36 OPERATION MANUAL

FEP-503 DRIVER RF PRE MIXER AND OSCILLATOR PC BOARD

SYM	PART NUMBER	DESCRIPTION
C46	8000-00010-050	Capacitor, Fixed, Ceramic, 30pF, 500V
C47	8000-00010-048	Capacitor, Fixed, Ceramic, 5pF, 500V
C48	8000-00010-054	Capacitor, Fixed, Ceramic, 0.01 μ F, 500V
C49	8000-00010-048	Capacitor, Fixed, Ceramic, 5pF, 500V
C50	8000-00010-048	Capacitor, Fixed, Ceramic, 5pF, 500V
C50T	8000-00010-074	Capacitor, Fixed, 1200pF, 500V
C51T	8000-00010-075	Capacitor, Fixed, 68pF, 500V
C52	8000-00010-053	Capacitor, Fixed, Ceramic, 0.005 μ F, 500V
C53	8000-00010-053	Capacitor, Fixed, Ceramic, 0.005 μ F, 500V
C54	8000-00010-050	Capacitor, Fixed, Ceramic, 30pF, 500V
C5s	8000-00010-053	Capacitor, Fixed, Ceramic, 0.005 μ F, 500V
C56	8000-00010-053	Capacitor, Fixed, Ceramic, 0.005 μ F, 500V
C57	8000-00010-050	Capacitor, Fixed, Ceramic, 30pF, 500V
C58	8000-00010-048	Capacitor, Fixed, Ceramic, 5pF, 500V
C59	8000-00010-052	Capacitor, Fixed, Ceramic, 0.001 μ F, 500V
C60	8000-00010-053	Capacitor, Fixed, Ceramic, 0.005 μ F, 500V
C61	8000-00010-053	Capacitor, Fixed, Ceramic, 0.005 μ F, 500V
C62	8000-00010-060	Capacitor, Fixed, Ceramic, 330pF, 500V
C63	8000-00010-054	Capacitor, Fixed, Ceramic, 0.01 μ F, 500V
C64	8000-00010-052	Capacitor, Fixed, Ceramic, 0.001 μ F, 500V
C65	8000-00010-054	Capacitor, Fixed, Ceramic, 0.01 μ F, 500V
C66	8000-00010-053	Capacitor, Fixed, Ceramic, 0.005 μ F, 500V
C67	8000-00010-059	Capacitor, Fixed, Mica, 250pF, 500V
C68	8000-00010-057	Capacitor, Fixed, Mica, 100pF, 500V
C69	8000-00010-058	Capacitor, Fixed, Mica, 150pF, 500V
C70	8000-00010-059	Capacitor, Fixed, Mica, 250pF, 500V
C73	8000-00010-053	Capacitor, Fixed, Ceramic, 0.005 μ F, 500V
C74	8000-00010-053	Capacitor, Fixed, Ceramic, 0.005 μ F, 500V
C75	8000-00010-053	Capacitor, Fixed, Ceramic, 0.005 μ F, 500V
C76	8000-00010-060	Capacitor, Fixed, Ceramic, 330pF, 500V
C77	8000-00010-005	Capacitor, Fixed, Ceramic, 0.1 μ F, 50V
C625	8000-00010-005	Capacitor, Fixed, Ceramic, 0.1 μ F, 50V
C626	8000-00010-054	Capacitor, Fixed, Ceramic, 0.01 μ F, 500V
C627	8000-00010-052	Capacitor, Fixed, Ceramic, 0.001 μ F, 500V
C628	8000-00010-054	Capacitor, Fixed, Ceramic, 0.01 μ F, 500V
C631	8000-00010-069	Capacitor, Fixed, 50pF, 500
C632	8000-00010-053	Capacitor, Fixed, Ceramic, 0.005 μ F, 500V
C633	8000-00010-053	Capacitor, Fixed, Ceramic, 0.005 μ F, 500V
C634	8000-00010-053	Capacitor, Fixed, Ceramic, 0.005 mid, 500V
C635	8000-00010-053	Capacitor, Fixed, Ceramic, 0.005 μ F, 500V
C636	8000-00010-056	Capacitor, Fixed, Mylar, 0.1 μ F, 250V

SBE SB-36 OPERATION MANUAL

SYM	PART NUMBER	DESCRIPTION
C674	8000-00010-053	Capacitor, Fixed, Ceramic, 0.005 μ F, 500V
C675	8000-00010-053	Capacitor, Fixed, Ceramic, 0.005 μ F, 500V
C677	8000-00010-049	Capacitor, Fixed, Ceramic, 10pF, 500V
C678	8000-00010-054	Capacitor, Fixed, Ceramic, 0.01 μ F, 500V
C679	8000-00010-054	Capacitor, Fixed, Ceramic, 0.01 μ F, 500V
C681	8000-00010-061	Capacitor, Fixed, Electrolytic, 10 μ F, 160V
C801	8000-00010-053	Capacitor, Fixed, Ceramic, 0.005 μ F, 500V
L9	8000-00010-254	Coil, 28 MHz
L10	8000-00010-255	Coil, 21 MHz
L10A	8000-00010-259	Coil, 21.2 MHz
L11	8000-00010-256	Coil, 14 MHz
L12	8000-00010-257	Coil, 7 MHz
L13	8000-00010-258	Coil, 3.5 MHz
L14	8000-00010-076	Coil, 28 MHz
L15	8000-00010-077	Coil, 21 MHz
L16	8000-00010-078	Coil, 14 MHz
L17	8000-00010-079	Coil, 7 MHz
L18	8000-00010-080	Coil, 3.5 MHz
L19	8000-00010-081	Coil, 28 MHz
L20	8000-00010-082	Coil, 21 MHz
L21	8000-00010-083	Coil, 14 MHz
L22	8000-00010-084	Coil, 7 MHz
L23	8000-00010-085	Coil, 3.5 MHz
L24	8000-00010-260	Coil, 9MHz
L26	8000-00010-064	Choke
L27	8000-00010-065	Choke, RFC
L28	8000-00010-067	Choke
L29	8000-00010-065	Choke, RFC
L29A	8000-00010-065	Choke, RFC
TR10	8000-00010-046	Transistor, 2SC717
TR11	8000-00010-046	Transistor, 2SC717
V1	8000-00010-088	Tube, 6EJ7
V2	8000-00010-089	Tube, 6BQ5
V3	8000-00010-091	Tube, 6Aw8
V4	8000-00010-090	Tube, 6BZ5
	8000-00010-062	Socket, 7-Pin
	8000-00010-063	Socket, 9-Pin

SBE SB-36 OPERATION MANUAL

FEP-504 CRYSTAL OSCILLATOR PC BOARD

SYM	PART NUMBER	DESCRIPTION
L2	8000-00010-093	Coil, Oscillator, 28 MHz
L3	8000-00010-094	Coil, Oscillator
L4	8000-00010-094	Coil, Oscillator
L5	8000-00010-095	Coil, Oscillator
L6	8000-00010-095	Coil, Oscillator
VC2	8000-00010-097	Capacitor, Variable, 30pF
VC3	8000-00010-097	Capacitor, Variable, 30pF
VC4	8000-00010-097	Capacitor, Variable, 30pF
VC5	8000-00010-097	Capacitor, Variable, 30pF
VC6	8000-00010-097	Capacitor, Variable, 30pF
VC7	8000-00010-097	Capacitor, Variable, 30pF
VC8	8000-00010-097	Capacitor, Variable, 30pF
VC9	8000-00010-097	Capacitor, Variable, 30pF
X1	8000-00010-098	Crystal, 44.0 MHz
X2	8000-00010-099	Crystal, 43.5 MHz
X3	8000-00010-100	Crystal, 43.0 MHz
X4	8000-00010-101	Crystal, 42.5 MHz
X5	8000-00010-102	Crystal, 35.5 MHz
X6	8000-00010-103	Crystal, 28.5 MHz
X7	8000-00010-104	Crystal, 21.5 MHz
	8000-00010-096	Socket, Crystal

SBE SB-36 OPERATION MANUAL

FEP-504A HF CRYSTAL PRINTED CIRCUIT PC BOARD

SYM	PART NUMBER	DESCRIPTION
VC1	8000-00010-084	Capacitor, Fixed, Ceramic, Trimmer, 30pF
VC3	8000-00010-084	Capacitor, Fixed, Ceramic, Trimmer, 30pF
VC4	8000-00010-084	Capacitor, Fixed, Ceramic, Trimmer, 30pF
VC5	8000-00010-084	Capacitor, Fixed, Ceramic, Trimmer, 30pF
VC5A	8000-00010-084	Capacitor, Fixed, Ceramic, Trimmer, 30pF
VC6	8000-00010-084	Capacitor, Fixed, Ceramic, Trimmer, 30pF
VC6A	8000-00010-084	Capacitor, Fixed, Ceramic, Trimmer, 30pF
VC7	8000-00010-084	Capacitor, Fixed, Ceramic, Trimmer, 30pF
VC8	8000-00010-084	Capacitor, Fixed, Ceramic, Trimmer, 30pF
VC9	8000-00010-084	Capacitor, Fixed, Ceramic, Trimmer, 30pF
X1	8000-00010-216	Crystal, 44.0 MHz
X2	8000-00010-215	Crystal, 43.5 MHz
X3	8000-00010-211	Crystal, 43.0 MHz
X4	8000-00010-213	Crystal, 42.5 MHz
X5	8000-00010-212	Crystal, 35.5 MHz
X6	8000-00010-211	Crystal, 28.5 MHz
X7	8000-00010-210	Crystal, 21.5 MHz
	8000-00010-228	Socket, Crystal, HC-25U
	8000-00010-243	Printed Circuit Board, FEP-504A

SBE SB-36 OPERATION MANUAL

FEP-505 VOX AND ANTI-TRIP PC BOARD

SYM	PART NUMBER	DESCRIPTION
C77	8000-00010-007	Capacitor, Fixed, Electrolytic, 10 μ F, 16v
C77A	8000-00010-007	Capacitor, Fixed, Electrolytic, 10 μ F, 16v
C78	8000-00010-007	Capacitor, Fixed, Electrolytic, 10 μ F, 16v
C78A	8000-00010-007	Capacitor, Fixed, Electrolytic, 10 μ F, 16v
C79	8000-00010-007	Capacitor, Fixed, Electrolytic, 10 μ F, 16v
C79A	8000-00010-009	Capacitor, Fixed, Electrolytic, 47 μ F, 25V
C639	8000-00010-113	Capacitor, Fixed, Ceramic, 5000pF, 50V
C640	8000-00010-113	Capacitor, Fixed, Ceramic, 5000pF, 50V
C641	8000-00010-007	Capacitor, Fixed, Electrolytic, 10 μ F, 16V
C642	8000-00010-113	Capacitor, Fixed, Ceramic, 5000pF, 50V
D12	8000-00010-020	Diode, 1N60
D13	8000-00010-020	Diode, 1N60
D14	8000-00010-020	Diode, 1N60
D15	8000-00010-020	Diode, 1N60
TR12	8000-00010-002	Transistor, 2SC458
TR13	8000-00010-002	Transistor, 2SC458
TR13A	8000-00010-002	Transistor, 2SC458
TR14	8000-00010-105	Transistor, 2SC374
TR15	8000-00010-002	Transistor, 2SC458
VR501	8000-00010-112	Resistor, Variable, 50k Ω
VR502	8000-00010-112	Resistor, Variable, 50k Ω

SBE SB-36 OPERATION MANUAL

FEP-506 CARRIER OSCILLATOR PC BOARD

SYM	PART NUMBER	DESCRIPTION
C84	8000-00010-121	Capacitor, Fixed, Mica, 100pF, 50V
C87	8000-00010-122	Capacitor, Fixed, Mica, 200pF, 50V
C89	8000-00010-119	Capacitor, Fixed, Mica, 27pF, 50V
C90	8000-00010-120	Capacitor, Fixed, Mica, 47pF, 50V
C91	8000-00010-010	Capacitor, Fixed, Ceramic, 0.02 μ F, 50V
C643	8000-00010-119	Capacitor, Fixed, Mica 27pF, 50V
C650	8000-00010-004	Capacitor, Fixed, Ceramic, 0.1 μ F, 50V
C651	8000-00010-004	Capacitor, Fixed, Ceramic, 0.1 μ F, 50V
C652	8000-00010-004	Capacitor, Fixed, Ceramic, 0.1 μ F, 50V
RL3	8000-00010-015	Relay, 12 VDC
T13	8000-00010-124	Transformer, 9 MHz
T14	8000-00010-124	Transformer, 9 MHz
TR17	8000-00010-002	Transistor, 2SC458
TR19	8000-00010-002	Transistor, 2SC458
TR20	8000-00010-002	Transistor, 2sC458
VC201	8000-00010-123	Capacitor, Variable, 30pF
	8000-00010-126	Plug, 11-Pin

FEP-507 AF POWER AMPLIFIER PC BOARD

SYM	PART NUMBER	DESCRIPTION
C85A	8000-00010-116	Capacitor, Fixed, Electrolytic, 220 μ F, 16V
C95	8000-00010-009	Capacitor, Fixed, Electrolytic, 47 μ F, 25V
C96	8000-00010-115	Capacitor, Fixed, Electrolytic, 47 μ F, 16V
C97	8000-00010-114	Capacitor, Fixed, Electrolytic, 4.7 μ F, 16V
C98A	8000-00010-004	Capacitor, Fixed, Ceramic, 0.01 μ F, 50V
C98B	8000-00010-005	Capacitor, Fixed, Ceramic, 0.1 μ F, 50V
C99	8000-00010-004	Capacitor, Fixed, Ceramic, 0.01 μ F, 50V
C100	8000-00010-009	Capacitor, Fixed, Electrolytic, 47 μ F, 25V
C101	8000-00010-114	Capacitor, Fixed, Electrolytic, 4.7 μ F, 16V
D17	8000-00010-109	Diode, 1S155
D18	8000-00010-021	Diode, 10D1
D19	8000-00010-021	Diode, 10D1
TR22	8000-00010-107	Transistor, 2SC495
TR23	8000-00010-108	Transistor, 2SA496
TR24	8000-00010-106	Transistor, 2SC733GR
TR25	8000-00010-019	Transistor, 2SA495
VR10	8000-00010-111	Resistor, Variable, 10k Ω
VR11	8000-00010-161	Resistor, Variable, 1k Ω

SBE SB-36 OPERATION MANUAL

FEP-508 RECEIVER IF AND AGC AMPLIFIER PC BOARD

SYM	PART NUMBER	DESCRIPTION
C102	8000-00010-004	Capacitor, Fixed, Ceramic, 0.01 μ F, 50V
C103	8000-00010-004	Capacitor, Fixed, Ceramic, 0.01 μ F, 50V
C104	8000-00010-004	Capacitor, Fixed, Ceramic, 0.01 μ F, 50V
C105	8000-00010-036	Capacitor, Fixed, Ceramic, 1000pF, 50V
C106	8000-00010-010	Capacitor, Fixed, Ceramic, 0.02 μ F, 50V
C107	8000-00010-010	Capacitor, Fixed, Ceramic, 0.02 μ F, 50V
C108	8000-00010-010	Capacitor, Fixed, Ceramic, 0.02 μ F, 50V
C109	8000-00010-010	Capacitor, Fixed, Ceramic, 0.02 μ F, 50V
C110	8000-00010-010	Capacitor, Fixed, Ceramic, 0.02 μ F, 50V
C111	8000-00010-010	Capacitor, Fixed, Ceramic, 0.02 μ F, 50V
C112	8000-00010-010	Capacitor, Fixed, Ceramic, 0.02 μ F, 50V
C113	8000-00010-005	Capacitor, Fixed, Ceramic, 0.1 μ F, 50V
C114	8000-00010-010	Capacitor, Fixed, Ceramic, 0.02 μ F, 50V
C116	8000-00010-032	Capacitor, Fixed, Styrol, 22pF, 50V
C644	8000-00010-034	Capacitor, Fixed, Electrolytic, 10 μ F, 25V
C645	8000-00010-005	Capacitor, Fixed, Ceramic, 0.1 μ F, 50V
C646	8000-00010-010	Capacitor, Fixed, Ceramic, 0.02 μ F, 50V
C647	8000-00010-028	Capacitor, Fixed, Ceramic, 5pF, 50V
C648	8000-00010-035	Capacitor, Fixed, Electrolytic, 330 μ F, 10V
C649	8000-00010-010	Capacitor, Fixed, Ceramic, 0.02 μ F, 50V
C650	8000-00010-033	Capacitor, Fixed, Electrolytic, 1.0 μ F, 16V
C661	8000-00010-005	Capacitor, Fixed, Ceramic, 0.1 μ F, 50V
C670	8000-00010-036	Capacitor, Fixed, Ceramic, 1000pF, 50V
C672	8000-00010-031	Capacitor, Fixed, Ceramic, 0.01 μ F, 500V
C826	8000-00010-010	Capacitor, Fixed, Ceramic, 0.02 μ F, 50V
D18	8000-00010-020	Diode, 1N60
D19	8000-00010-020	Diode, 1N60
D20	8000-00010-020	Diode, 1N60
D21	8000-00010-020	Diode, 1N60
D22	8000-00010-020	Diode, 1N60
D23	8000-00010-020	Diode, 1N60
D24	8000-00010-022	Diode, RD-9A
D25	8000-00010-020	Diode, 1N60
D211	8000-00010-021	Diode, 10D-1
L50	8000-00010-039	Choke, RFC
L605	8000-00010-039	Choke, RFC
T15	8000-00010-038	Transformer, 9 MHz
T16	8000-00010-038	Transformer, 9 MHz
T17	8000-00010-038	Transformer, 9 MHz
T18	8000-00010-038	Transformer, 9 MHz
TR26	8000-00010-002	Transistor, 2SC458

SBE SB-36 OPERATION MANUAL

SYM	PART NUMBER	DESCRIPTION
TR27	8000-00010-002	Transistor, 2SC458
TR28	8000-00010-016	Transistor, 2SK25
TR29	8000-00010-002	Transistor, 2SC458
VR12	8000-00010-161	Resistor, Variable, 1k Ω
VR14	8000-00010-025	Resistor, Variable, 3k Ω
VR53	8000-00010-026	Resistor, Variable, 10k Ω

SBE SB-36 OPERATION MANUAL

FEP-509 VFO PC BOARD

SYM	PART NUMBER	DESCRIPTION
C120	8000-00010-131	Capacitor, Fixed, Mica, 5pF, 50V
C121	8000-00010-136	Capacitor, Fixed, Mica, 250pF, 50V
C122	8000-00010-113	Capacitor, Fixed, Ceramic, 5000pF, 50V
C123	8000-00010-134	Capacitor, Fixed, Mica, 500pF, 50V
C124	8000-00010-135	Capacitor, Fixed, Mica, 800pF, 50V
C127	8000-00010-132	Capacitor, Fixed, Mica, 50pF, 50V
C128	8000-00010-005	Capacitor, Fixed, Ceramic, 0.1 μ F, 50V
C128A	8000-00010-005	Capacitor, Fixed, Ceramic, 0.1 μ F, 50V
C129	8000-00010-137	Capacitor, Fixed, Ceramic, 1000pF, 50V
C130	8000-00010-137	Capacitor, Fixed, Ceramic, 1000pF, 50V
C131	8000-00010-005	Capacitor, Fixed, Ceramic, 0.1 μ F, 50V
C133	8000-00010-133	Capacitor, Fixed, Mica, 150pF, 50V
C134	8000-00010-137	Capacitor, Fixed, Ceramic, 1000pF, 50V
C135	8000-00010-010	Capacitor, Fixed, Ceramic, 0.02 μ F, 50V
C651	8000-00010-005	Capacitor, Fixed, Ceramic, 0.1 μ F, 50V
C696	8000-00010-004	Capacitor, Fixed, Ceramic, 0.01 μ F, 50V
C698	8000-00010-004	Capacitor, Fixed, Ceramic, 0.01 μ F, 50V
C698A	8000-00010-134	Capacitor, Fixed, Mica, 500pF, 50V
c750	8000-00010-004	Capacitor, Fixed, Ceramic, 0.01 μ F, 50V
D26	8000-00010-020	Diode, 1N60
D27	8000-00010-020	Diode, 1N60
D29	8000-00010-128	Diode, 1S338
D60	8000-00010-020	Diode, 1N60
D211	8000-00010-127	Diode, 1S48
L31	8000-00010-140	Choke
L32	8000-00010-139	Choke
L34	8000-00010-141	Choke
L509	8000-00010-142	Choke
TR30	8000-00010-016	Transistor, 2SK25
TR31	8000-00010-018	Transistor, 2SK30
TR32	8000-00010-002	Transistor, 2SC458
TR48	8000-00010-002	Transistor, 2SC458
VC509	8000-00010-138	Capacitor, Variable, 5-54pF
VR51	8000-00010-129	Resistor, Variable, 3k Ω
VR52	8000-00010-130	Resistor, Variable, 5k Ω

SBE SB-36 OPERATION MANUAL

FEP-510 COUNTER PC BOARD

SYM	PART NUMBER	DESCRIPTION
C1	8000-00010-097	Capacitor, Fixed, Mica, 330pF, 50V
C2	8000-00010-097	Capacitor, Fixed, Mica, 330pF, 50V
C3	8000-00010-097	Capacitor, Fixed, Mica, 330pF, 50V
C4	8000-00010-097	Capacitor, Fixed, Mica, 330pF, 50V
C5	8000-00010-097	Capacitor, Fixed, Mica, 330pF, 50V
C6	8000-00010-097	Capacitor, Fixed, Mica, 330pF, 50V
C1	8000-00010-091	Capacitor, Fixed, Styrol, 1500pF, 50V
C8	8000-00010-126	Capacitor, Fixed, Ceramic, 0.01 μ F, 500V
C9	8000-00010-117	Capacitor, Fixed, Mylar, 0.01 μ F, 50V
C10	8000-00010-117	Capacitor, Fixed, Mylar, 0.01 μ F, 50V
C11	8000-00010-117	Capacitor, Fixed, Mylar, 0.01 μ F, 50V
C12	8000-00010-117	Capacitor, Fixed, Mylar, 0.01 μ F, 50V
C13	8000-00010-118	Capacitor, Fixed, Mylar, 0.1 μ F, 50V
C14	8000-00010-118	Capacitor, Fixed, Mylar, 0.1 μ F, 50V
C15	8000-00010-127	Capacitor, Fixed, Ceramic, 0.1 μ F, 50V
C16	8000-00010-127	Capacitor, Fixed, Ceramic, 0.1 μ F, 50V
C17	8000-00010-127	Capacitor, Fixed, Ceramic, 0.1 μ F, 50V
C18	8000-00010-066	Capacitor, Fixed, Electrolytic, 33 μ F, 16V
C19	8000-00010-066	Capacitor, Fixed, Electrolytic, 33 μ F, 16V
C20	8000-00010-066	Capacitor, Fixed, Electrolytic, 33 μ F, 16V
D1	8000-00010-027	Diode, RD-5A
D2	8000-00010-027	Diode, RD-5A
IC1	8000-00010-149	Integrated Circuit, FEP-505
IC2	8000-00010-149	Integrated Circuit, FEP-505
IC3	8000-00010-149	Integrated Circuit, FEP-505
IC4	8000-00010-150	Integrated Circuit, FEP-506
IC5	8000-00010-150	Integrated Circuit, FEP-506
IC6	8000-00010-150	Integrated Circuit, FEP-506
IC7	8000-00010-148	Integrated Circuit, FEP-504
IC8	8000-00010-145	Integrated Circuit, FEP-501
IC9	8000-00010-144	Integrated Circuit, FEP-500
IC10	8000-00010-144	Integrated Circuit, FEP-500
IC11	8000-00010-144	Integrated Circuit, FEP-500
IC12	8000-00010-146	Integrated Circuit, FEP-502
IC13	8000-00010-146	Integrated Circuit, FEP-502
IC14	8000-00010-146	Integrated Circuit, FEP-502
IC15	8000-00010-146	Integrated Circuit, FEP-502
IC16	8000-00010-144	Integrated Circuit, FEP-500
IC17	8000-00010-144	Integrated Circuit, FEP-500
IC18	8000-00010-144	Integrated Circuit, FEP-500
IC19	8000-00010-151	Integrated Circuit, FEP-507

SBE SB-36 OPERATION MANUAL

SYM	PART NUMBER	DESCRIPTION
IC20	8000-00010-146	Integrated Circuit, FEP-502
IC21	8000-00010-147	Integrated Circuit, FEP-503
IC22	8000-00010-148	Integrated Circuit, FEP-504
IC23	8000-00010-148	Integrated Circuit, FEP-504
IC24	8000-00010-146	Integrated Circuit, FEP-502
IC25	8000-00010-148	Integrated Circuit, FEP-504
IC26	8000-00010-144	Integrated Circuit, FEP-500
IC27	8000-00010-144	Integrated Circuit, FEP-500
IC28	8000-00010-144	Integrated Circuit, FEP-500
IC29	8000-00010-150	Integrated Circuit, FEP-506
IC30	8000-00010-149	Integrated Circuit, FEP-505
V1	8000-00010-153	Tube, Nixie
V2	8000-00010-153	Tube, Nixie
V3	8000-00010-153	Tube, Nixie
V4	8000-00010-153	Tube, Nixie
V5	8000-00010-153	Tube, Nixie
V6	8000-00010-153	Tube, Nixie
	8000-00010-240	Printed Circuit Board, FEP-S10

SBE SB-36 OPERATION MANUAL

FEP-511 5.6 MHz OSCILLATOR/UPPER AND LOWER LIMIT LIGHT PC BOARD

SYM	PART NUMBER	DESCRIPTION
C1	8000-00010-162	Capacitor, Fixed, Mica, 30pF, 50V
C2	8000-00010-010	Capacitor, Fixed, Ceramic, 0.02 μ F, 50V
C3	8000-00010-121	Capacitor, Fixed, Mica, 100pF, 50V
C4	8000-00010-059	Capacitor, Fixed, Mica, 250pF, 50V
C5	8000-00010-120	Capacitor, Fixed, Mica, 50pF, 50V
C5B	8000-00010-120	Capacitor, Fixed, Mica, 50pF, 50V
C6	8000-00010-004	Capacitor, Fixed, Ceramic, 0.01 μ F, 50V
C7	8000-00010-120	Capacitor, Fixed, Mica, 50pF, 50V
C8	8000-00010-055	Capacitor, Fixed, Styrol, 500pF, 50V
C9	8000-00010-005	Capacitor, Fixed, Ceramic, 0.1 μ F, 50V
C10	8000-00010-005	Capacitor, Fixed, Ceramic, 0.1 μ F, 50V
C11	8000-00010-055	Capacitor, Fixed, Styrol, 500pF, 50V
C13A	8000-00010-164	Capacitor, Fixed, Mylar, 0.1 μ F, 50V
C13B	8000-00010-163	Capacitor, Fixed, Styrol, 1000pF, 50V
C14	8000-00010-155	Capacitor, Fixed, Styrol, 1500pF, 50V
C15	8000-00010-059	Capacitor, Fixed, Mica, 250pF, 50V
C16	8000-00010-165	Capacitor, Fixed, Mylar, 0.5 μ F, 50V
C17	8000-00010-165	Capacitor, Fixed, Mylar, 0.5 μ F, 50V
C18	8000-00010-004	Capacitor, Fixed, Ceramic, 0.01 μ F, 50V
C19	8000-00010-004	Capacitor, Fixed, Ceramic, 0.01 μ F, 50V
C20a	8000-00010-164	Capacitor, Fixed, Mylar, 0.1 μ F, 50V
C20b	8000-00010-163	Capacitor, Fixed, Styrol, 1000pF, 50V
C20d	8000-00010-122	Capacitor, Fixed, Mica, 100pF, 50V
C20e	8000-00010-164	Capacitor, Fixed, Mylar, 0.1 μ F, 50V
C003	8000-00010-169	Capacitor, Fixed, Electrolytic, 330 μ F, 16V
C004	8000-00010-174	Capacitor, Fixed, Ceramic, 0.005 μ F, 500V
C005	8000-00010-174	Capacitor, Fixed, Ceramic, 0.005 μ F, 500V
C006	8000-00010-005	Capacitor, Fixed, Ceramic, 0.1 μ F, 50V
C007	8000-00010-005	Capacitor, Fixed, Ceramic, 0.1 μ F, 50V
C008	8000-00010-17?	Capacitor, Fixed, Ceramic, 0.005 μ F, 500V
C206	8000-00010-005	Capacitor, Fixed, Ceramic, 0.1 μ F, 50V
C501	8000-00010-115	Capacitor, Fixed, Electrolytic, 47 μ F, 16V
C503	8000-00010-007	Capacitor, Fixed, Electrolytic, 10 μ F, 16V
C503a	8000-00010-005	Capacitor, Fixed, Ceramic, 0.1 μ F, 50V
C504a	8000-00010-122	Capacitor, Fixed, Mica, 1000pF, 50V
C504b	8000-00010-004	Capacitor, Fixed, Ceramic, 0.01 μ F, 50V
C506	8000-00010-168	Capacitor, Fixed, Electrolytic, 100 μ F, 10V
D1	8000-00010-152	Diode, RD-5A
D2	8000-00010-152	Diode, RD-5A
L1	8000-00010-170	Coil

SBE SB-36 OPERATION MANUAL

SYM	PART NUMBER	DESCRIPTION
L2	8000-00010-171	Coil
L3	8000-00010-172	Coil
TR33	8000-00010-002	Transistor, 2SC458
TR34	8000-00010-002	Transistor, 2SC458
TR35	8000-00010-002	Transistor, 2SC458
TR36	8000-00010-002	Transistor, 2SC458
TR37	8000-00010-002	Transistor, 2SC458
TR38	8000-00010-002	Transistor, 2SC458
TR39	8000-00010-002	Transistor, 2SC458
TR40	8000-00010-002	Transistor, 2SC458
TR41	8000-00010-105	Transistor, 2SC374
TR42	8000-00010-002	Transistor, 2SC458
TR43	8000-00010-002	Transistor, 2SC458
TR44	8000-00010-002	Transistor, 2SC458
TR45	8000-00010-160	Transistor, 2SC373
TR46	8000-00010-175	Transistor, 2SC491
TR47	8000-00010-002	Transistor, 2SC458
R503	8000-00010-185	Resistor, Fixed, 0.5Ω, 2W
VC1	8000-00010-123	Capacitor, Variable, 30pF
VR18	8000-00010-161	Resistor, Variable, 1kΩ
X1	8000-00010-159	Crystal, 5.6 MHz

SBE SB-36 OPERATION MANUAL

FEP-531 POWER SUPPLY PC BOARD

SYM	PART NUMBER	DESCRIPTION
C504	8000-00010-177	Capacitor, Fixed, Electrolytic, 100 μ F, 250V
C505	8000-00010-178	Capacitor, Fixed, Electrolytic, 470 μ F, 16V
C506	8000-00010-179	Capacitor, Fixed, Electrolytic, 1000 μ F, 35V
C507	8000-00010-179	Capacitor, Fixed, Electrolytic, 1000 μ F, 35V
D501	8000-00010-176	Diode, 10D-10
D502	8000-00010-176	Diode, 10D-10
D503	8000-00010-176	Diode, 10D-10
D504	8000-00010-176	Diode, 10D-10
D506	8000-00010-176	Diode, 10D-10
D507	8000-00010-176	Diode, 10D-10
D508	8000-00010-176	Diode, 10D-10
D509	8000-00010-176	Diode, 10D-10
D510	8000-00010-176	Diode, 10D-10
D511	8000-00010-176	Diode, 10D-10
D512	8000-00010-176	Diode, 10D-10
D513	8000-00010-021	Diode, 10D-1
D514	8000-00010-021	Diode, 10D-1
D515	8000-00010-021	Diode, 10D-1
D516	8000-00010-021	Diode, 10D-1

FEP-532 20V REGULATOR PC BOARD

SYM	PART NUMBER	DESCRIPTION
C511	8000-00010-005	Capacitor, Fixed, Ceramic, 0.1 μ F, 50V
C512	8000-00010-007	Capacitor, Fixed, Electrolytic, 10 μ F, 16V
C513	8000-00010-183	Capacitor, Fixed, Electrolytic, 220 μ F, 16V
D31	8000-00010-128	Diode, RD-16A
R512	8000-00010-180	Resistor, Fixed, 1 Ω , 2W
TR45	8000-00010-002	Transistor, 2SC458
TR46	8000-00010-175	Transistor, 2SC491
TR47	8000-00010-002	Transistor, 2SC458
VR19	8000-00010-181	Resistor, Variable, 1k Ω
	8000-00010-182	TR-46 Heat Sink
	8000-00010-184	L Angle Bracket

SBE SB-36 OPERATION MANUAL

AC POWER SUPPLY CHASSIS

SYM	PART NUMBER	DESCRIPTION
C5	8000-00010-073	Capacitor, Fixed, Electrolytic, 47 μ F, 500V
C5a	8000-00010-073	Capacitor, Fixed, Electrolytic, 47 μ F, 500V
C501	Not Used	
C502	Not Used	
C503	8000-00010-073	Capacitor, Fixed, Electrolytic, 47 μ F, 500V
C508	8000-00010-144	Capacitor, Fixed, Ceramic, 0.01 μ F, 1kV
R509	8000-00010-052	Resistor, Fixed, 1k Ω , 7 W
R510	8000-00010-053	Resistor, Fixed, 5k Ω , 10 W
T001	8000-00010-171	Transformer, Primary Power
	8000-00010-238	Printed Circuit Board
	8000-00010-226	Jack, Speaker
	8000-00010-259	Bakelite Board, Spkr, Jack Mounting
	8000-00010-227	Socket, 11-Pin
	8000-00010-219	Relay
	8000-00010-261	Speaker, 8 Ω
	8000-00010-260	Fuse Holder
	8000-00010-262	Speaker Grill
	8000-00010-263	Cabinet
	8000-00010-265	Fuse, 5A Fast-Blo

SBE SB-36 OPERATION MANUAL

SB-36 MAIN CHASSIS

SYM	PART NUMBER	DESCRIPTION
C25	8000-00010-207	Capacitor, Fixed, Ceramic, 0.005 μ F, 500V
C35	8000-00010-207	Capacitor, Fixed, Ceramic, 0.005 μ F, 500V
C45	8000-00010-207	Capacitor, Fixed, Ceramic, 0.005 μ F, 500V
C55	8000-00010-213	Capacitor, Fixed, Ceramic, 0.002 μ F, 3kV
C65	8000-00010-189	Capacitor, Fixed, Ceramic, 0.01 μ F, 1.4kV
C71	8000-00010-210	Capacitor, Fixed, Ceramic, 300pF, 500V
C74	8000-00010-210	Capacitor, Fixed, Ceramic, 300pF, 500V
C75	8000-00010-211	Capacitor, Fixed, Ceramic, 470pF, 1.6kV
C85	8000-00010-005	Capacitor, Fixed, Ceramic, 0.1 μ F, 50V
C674	8000-00010-209	Capacitor, Fixed, Ceramic, 0.002 μ F, 500V
C675	8000-00010-209	Capacitor, Fixed, Ceramic, 0.002 μ F, 500V
C695	8000-00010-212	Capacitor, Fixed, Ceramic, 150pF, 500V
C701	8000-00010-207	Capacitor, Fixed, Ceramic, 0.005 μ F, 500V
C702	8000-00010-207	Capacitor, Fixed, Ceramic, 0.005 μ F, 500V
C703	8000-00010-207	Capacitor, Fixed, Ceramic, 0.005 μ F, 500V
C710	8000-00010-212	Capacitor, Fixed, Ceramic, 150pF, 500V
C205	8000-00010-020	Diode, 1N60
L55	8000-00010-235	Choke
L75	8000-00010-234	Choke
L85	8000-00010-234	Choke
L205	8000-00010-230	Choke, Plate
L215	8000-00010-231	Coil, Tank
L225	8000-00010-232	Coil, Tank, 10 Meter
L305	8000-00010-233	Choke
L315	8000-00010-233	Choke
R15	8000-00010-228	Resistor, Fixed, 0.5 Ω
R95	8000-00010-229	Resistor, Fixed, 5k Ω , 10 w
RL1	8000-00010-215	Relay, MH4
RL2	8000-00010-214	Relay, 4-Pole
S1	8000-00010-200	Switch, Mode
S2	8000-00010-202	Switch, Band
S3	8000-00010-201	Switch, 3-Position, Meter
S4	8000-00010-206	Switch, Noise Blanker
S5	8000-00010-203	Switch, AGC
S6	8000-00010-205	Switch, Push Button
S7	8000-00010-204	Switch, 2p-3T
S8	8000-00010-205	Switch, Push-Button
V5	8000-00010-092	Tube, 6KD6
V6	8000-00010-092	Tube, 6KD6
VC10	8000-00010-226	Capacitor, Variable
VC15	8000-00010-225	Capacitor, Variable, 10pF

SBE SB-36 OPERATION MANUAL

SYM	PART NUMBER	DESCRIPTION
VC25	8000-00010-224	Capacitor, Variable, 280pF
VC35	8000-00010-227	Capacitor, Variable
VC45	8000-00010-223	Capacitor, Variable, 10pF
VR25	8000-00010-221	Resistor, Variable, 10k Ω
VR35	8000-00010-219	Resistor, Variable, 1M Ω
VR45	8000-00010-218	Resistor, Variable, 10k Ω
VR503	8000-00010-216	Resistor, Variable, 100k Ω
VR504	8000-00010-217	Resistor, Variable, 10k Ω
VR509	8000-00010-222	Resistor, Variable, 10k Ω
VR601	8000-00010-220	Resistor, Variable, 50k X 2 Ω
	8000-00010-236	Jack, 2-Pole
	8000-00010-237	Lamp, RIT
	8000-00010-238	Socket, 12-Pin
	8000-00010-239	Capacitor, Plate, 6KD6
	8000-00010-240	Meter, 300 μ A
	8000-00010-241	Motor, AC
	8000-00010-243	Knob, VFO
	8000-00010-244	Knob, Plate Load
	8000-00010-245	Knob, Pre-Selector
	8000-00010-246	Knob, Mac Gain
	8000-00010-247	Shield, Tube, 7-Pin Type
	8000-00010-248	Shield, Tube, 9-Pin Type
	8000-00010-249	Knob, Band Selector
	8000-00010-250	Knob, RF Gain
	8000-00010-261	Front Panel, Complete
	8000-00010-262	Feet, Rubber
	8000-00010-263	Feet, Metal
	8000-00010-264	Capacitor, Fixed, Electrolytic, 1000 μ F, 16V
	8000-00010-265	High Voltage Warning Tag
	8000-00010-266	Jack Strip, Accessory Output
	8000-00010-267	Terminal Strip, 4-Pose
	8000-00010-268	Socket, Lamp, Push-On Type
	8000-00010-269	Socket, Lamp, Bolt-On Type
	8000-00010-270	Core, Transformer slug
	8000-00010-271	Gear Assembly, VFO
	8000-00010-272	Bezel, Front Panel

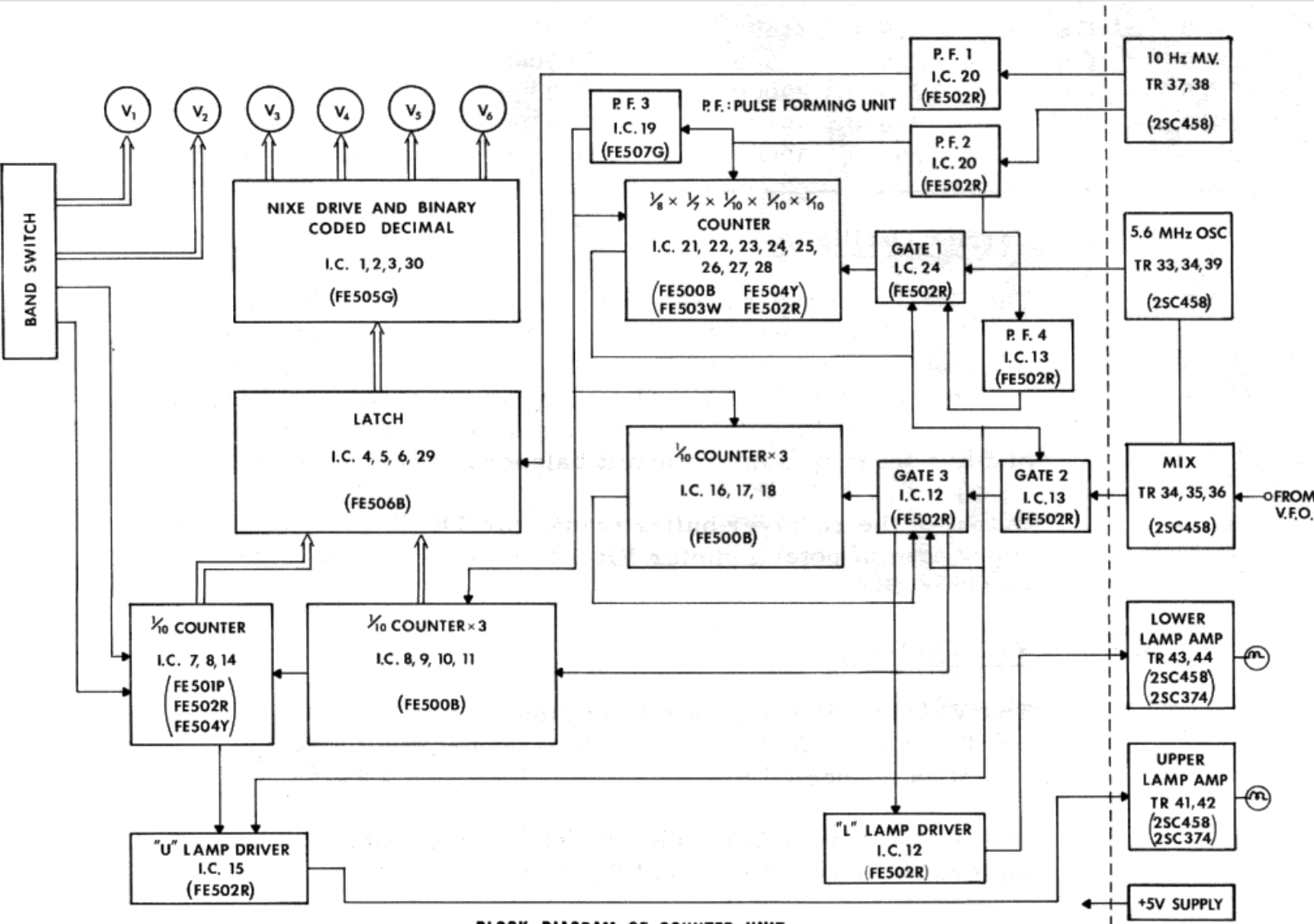

BLOCK DIAGRAM OF COUNTER UNIT

FIGURE 5.3

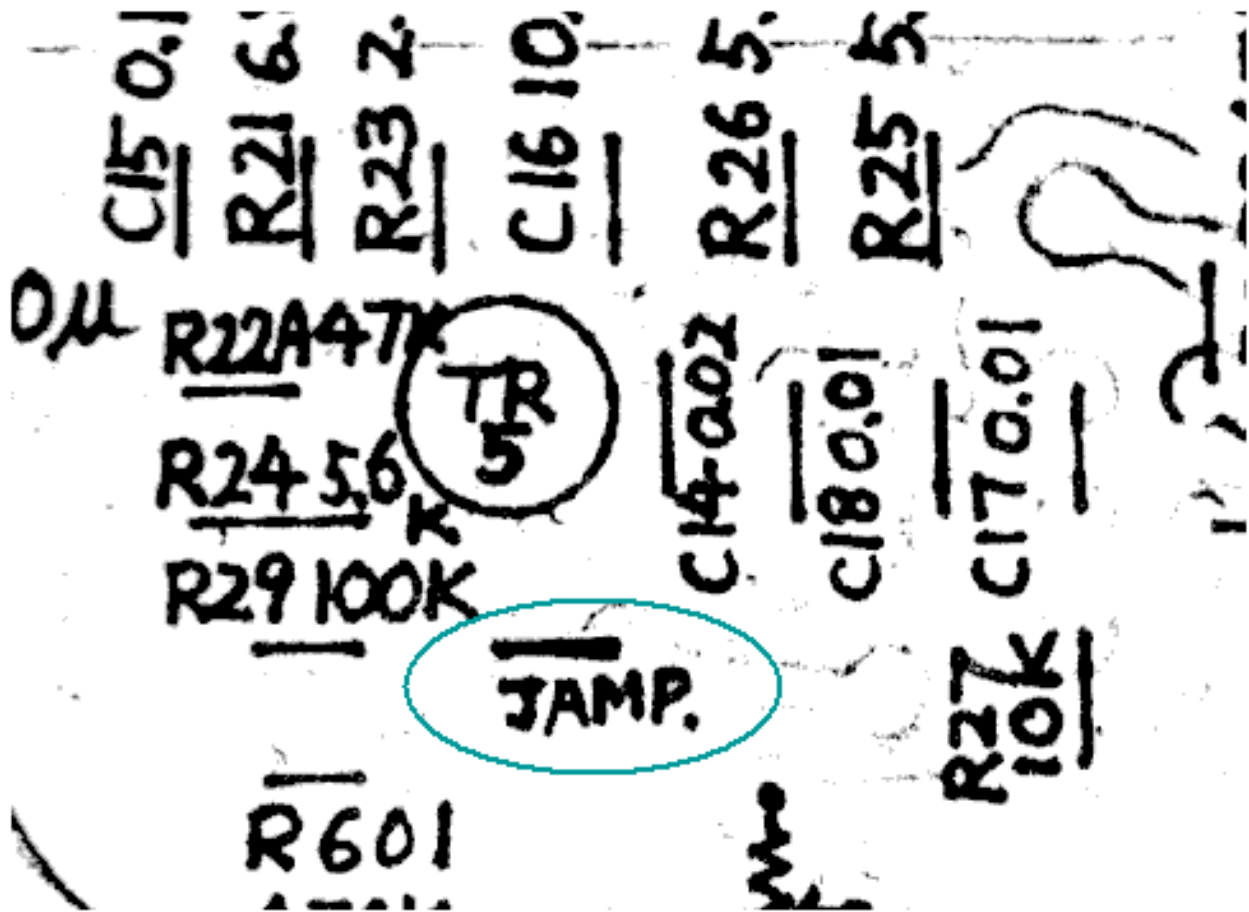

JAPANINGLISH FOUND IN SB-36 MANUAL
(SHOULD BE "JUMP.")

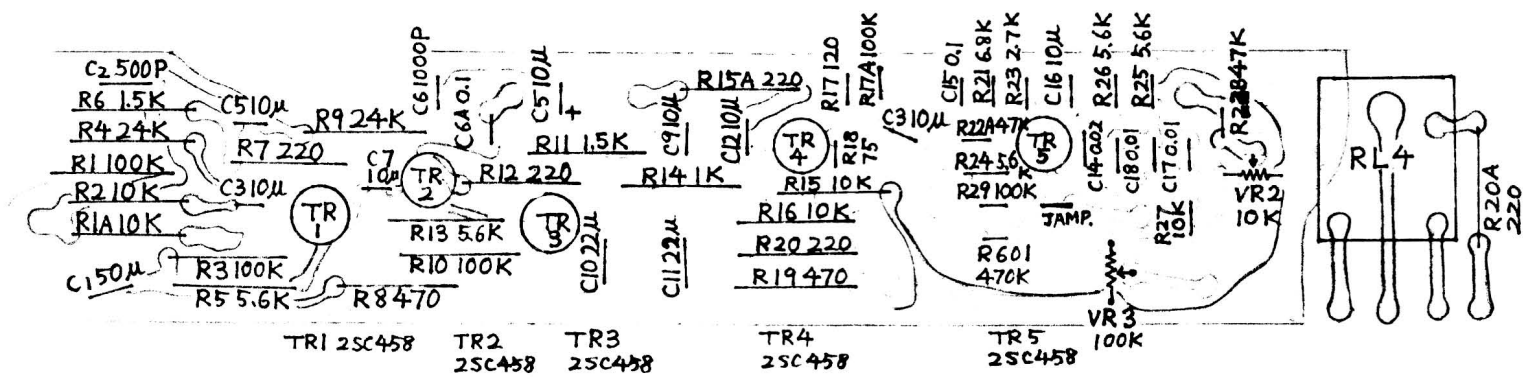

FEP 501
MICROPHONE AMPLIFIER/
SIDETONE OSCILLATOR

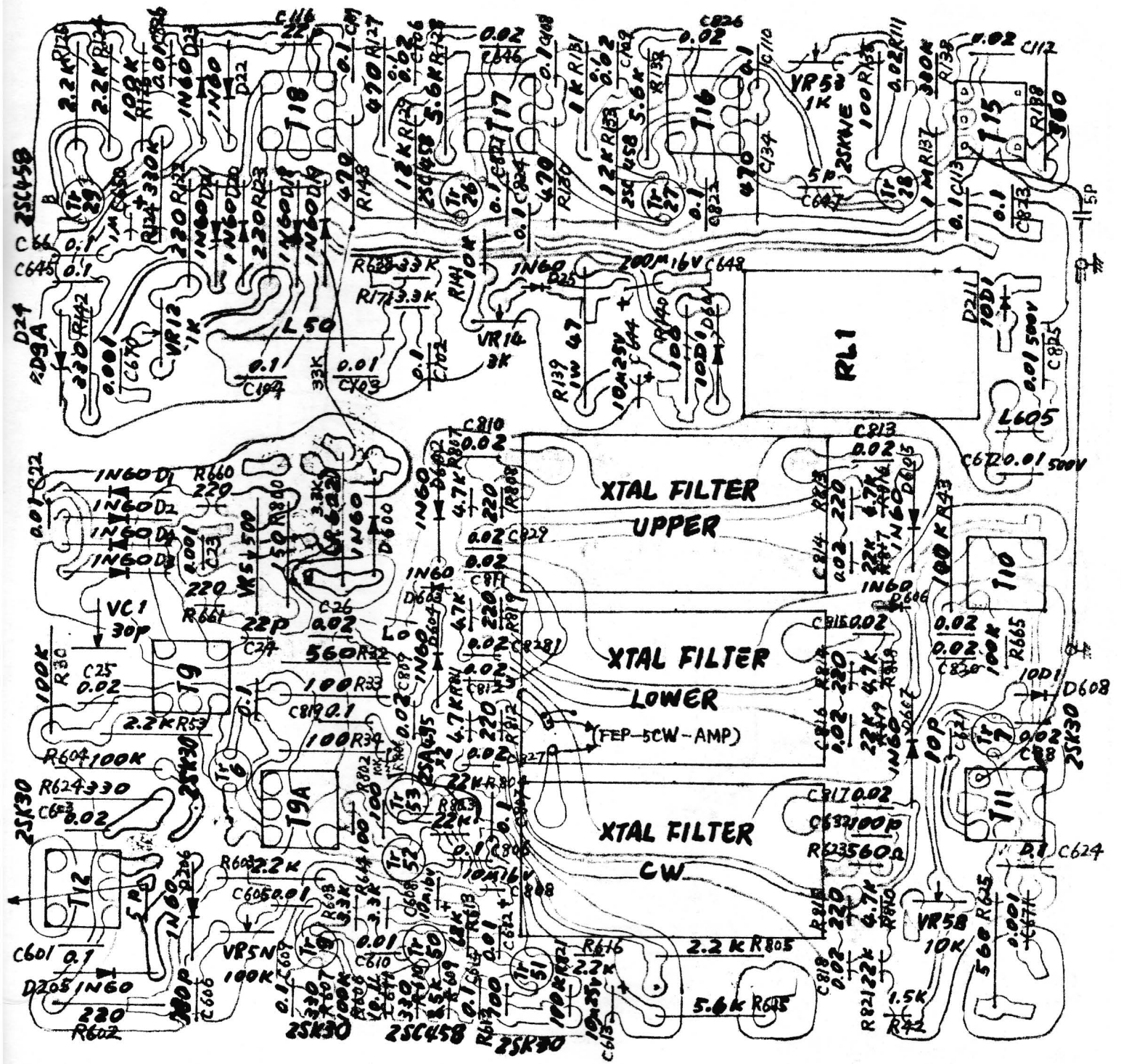

FEP-502 and 508
 TRANSMIT / RECEIVE
 9MHz AMPLIFIER

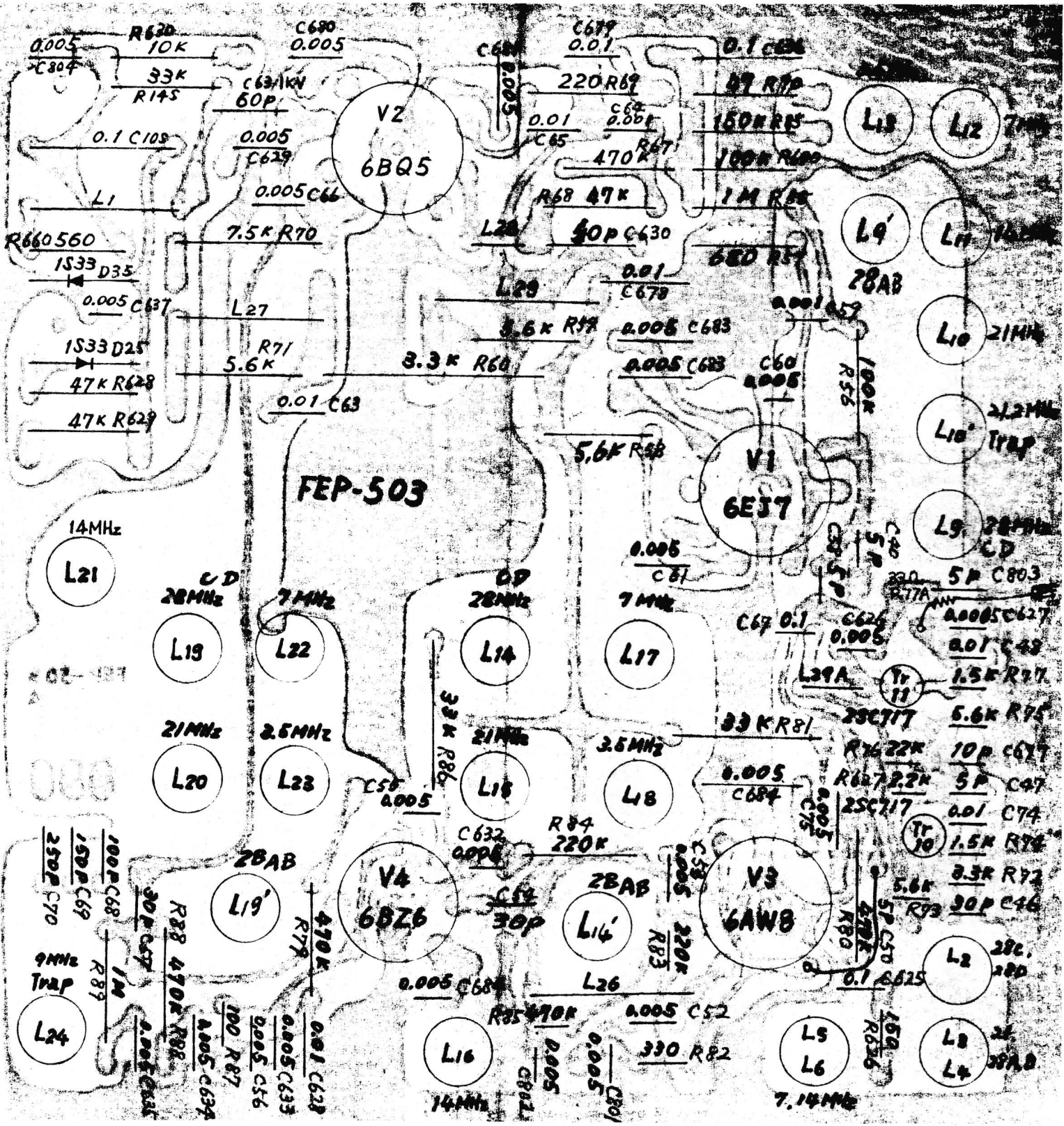

FEP-503
 TRANSMIT / RECEIVE
 RF AMPLIFIERS

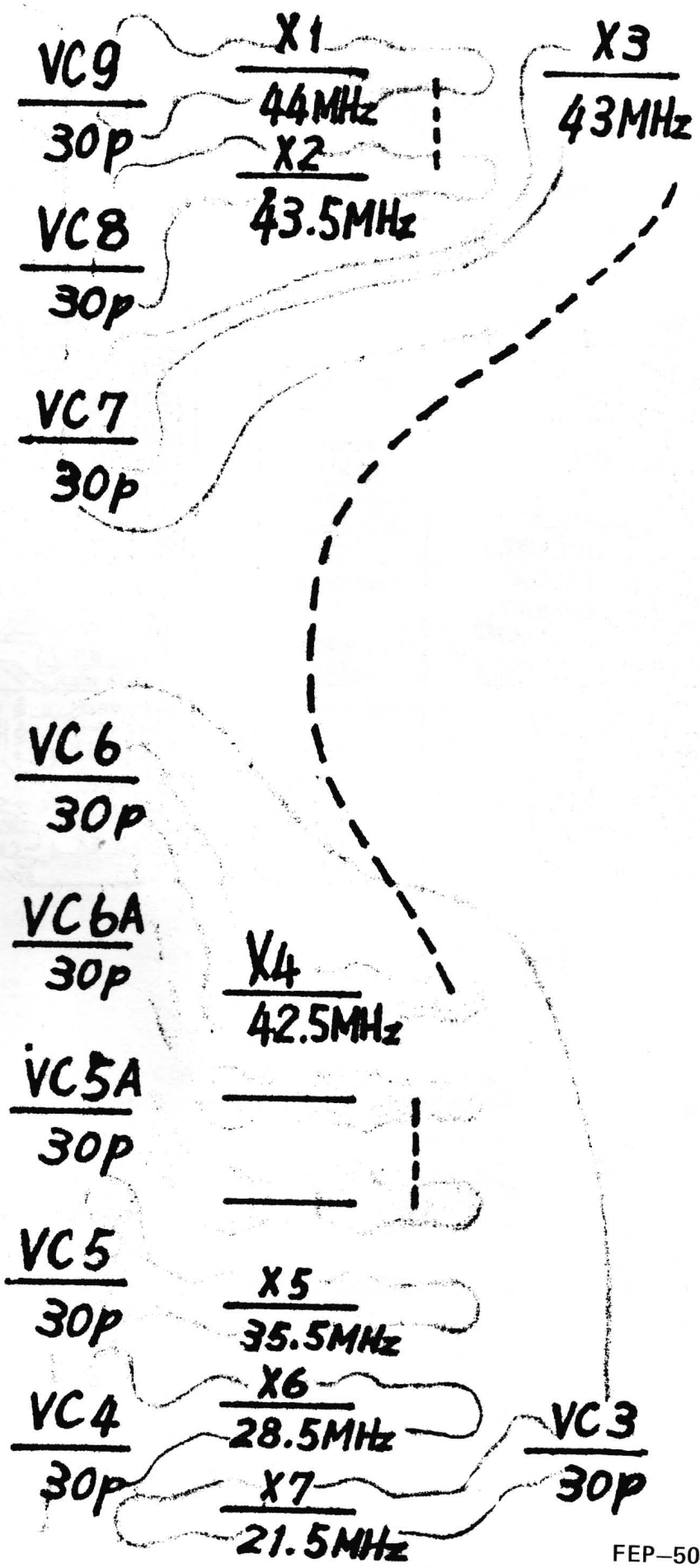

FEP-504A
HFO OSCILLATOR

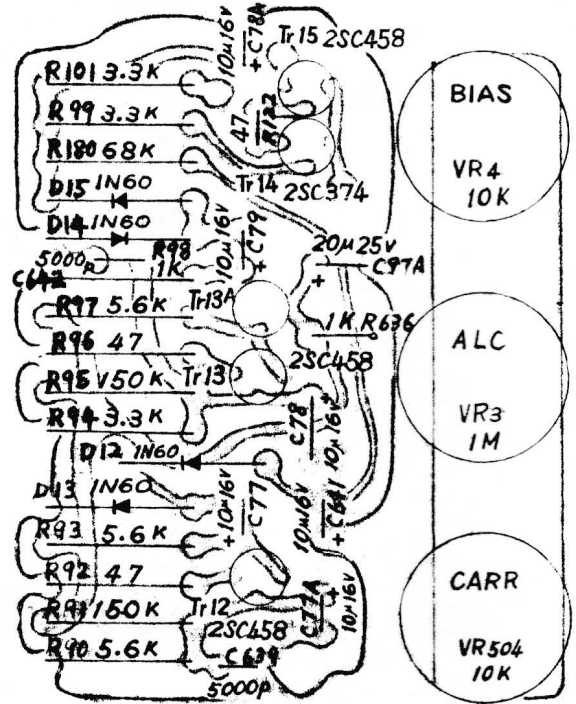
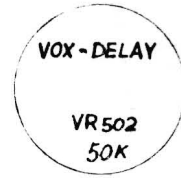
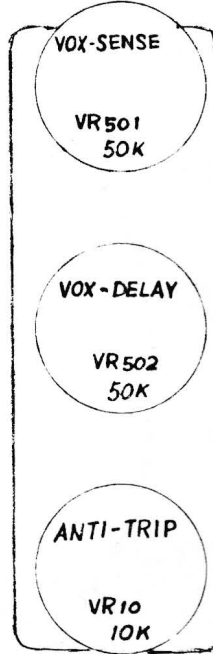
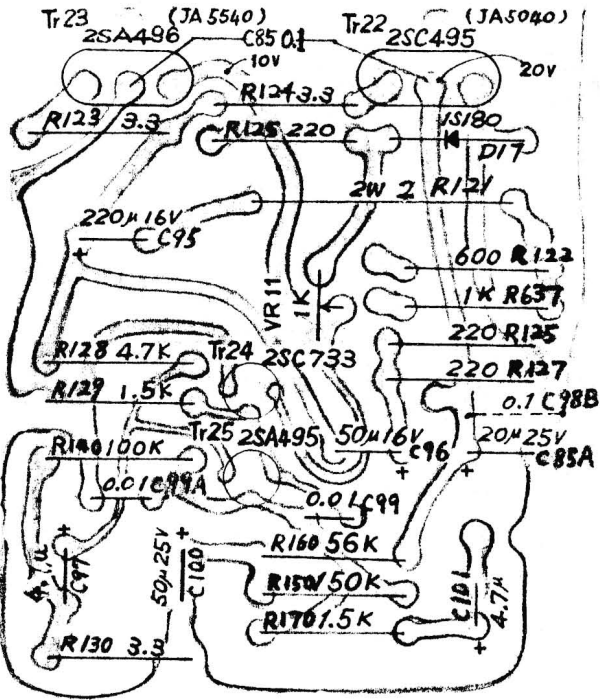

FEP-505/507
AF AMPLIFIER

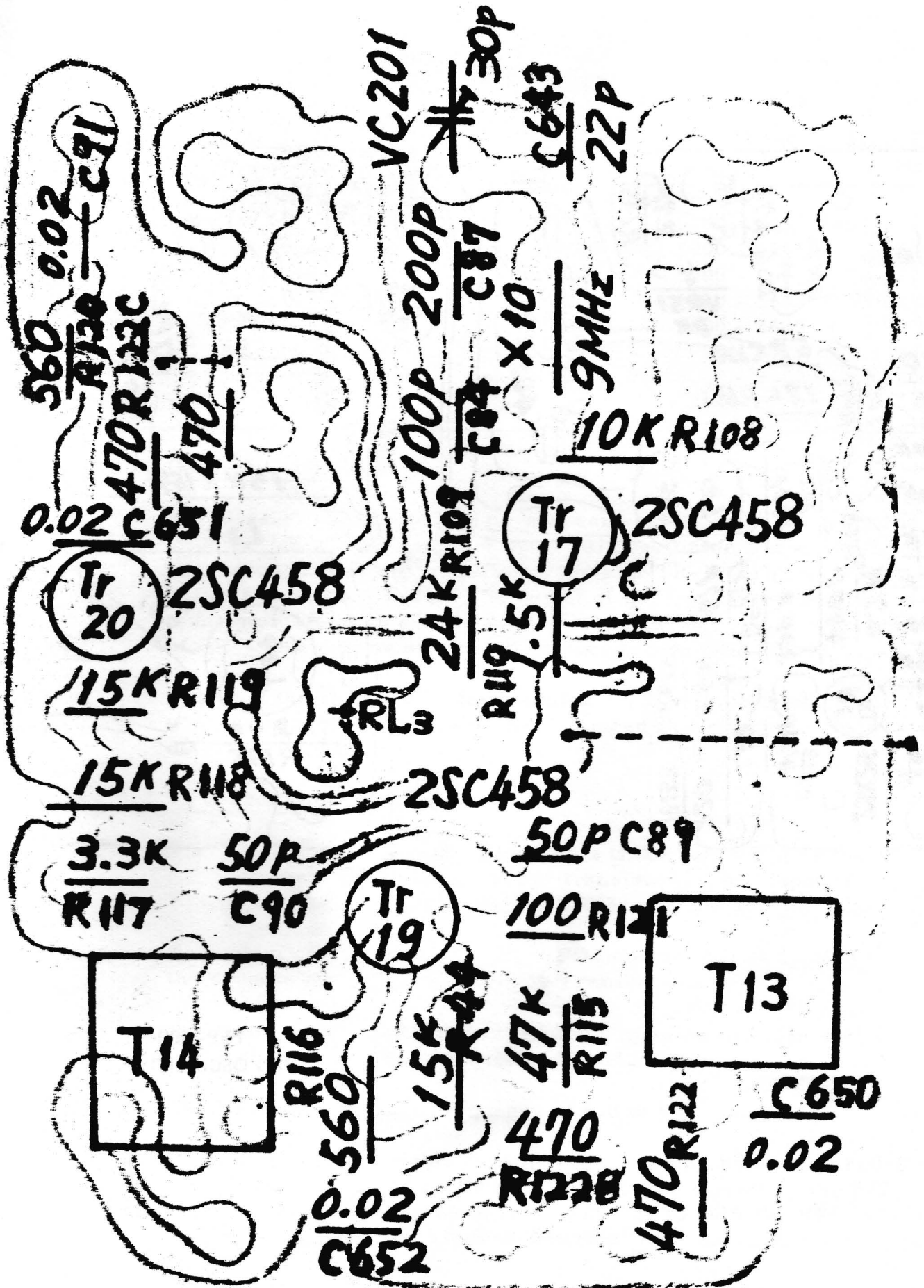

FEP-506
9MHz OSCILLATOR

Tx Frequency Adjustment

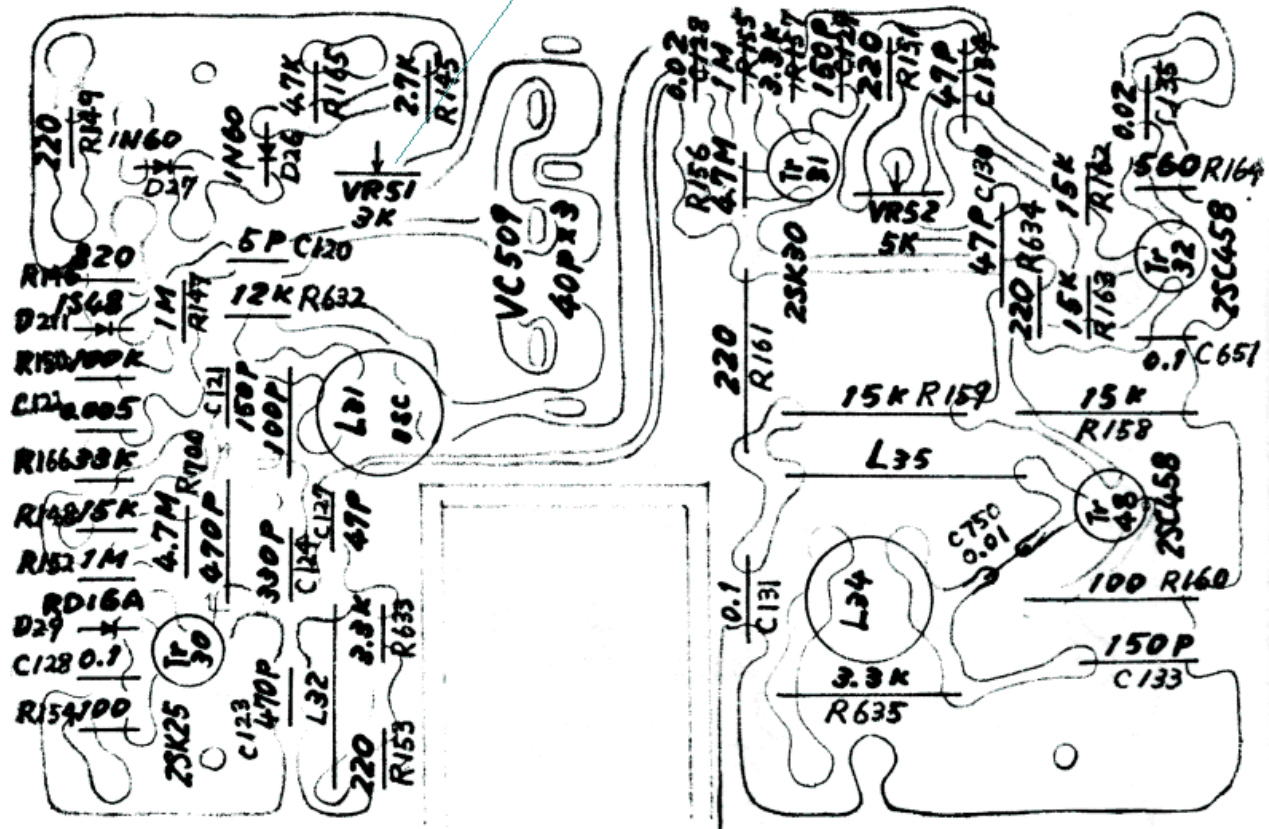

SBE SB-36 FEP-509 VFO BOARD

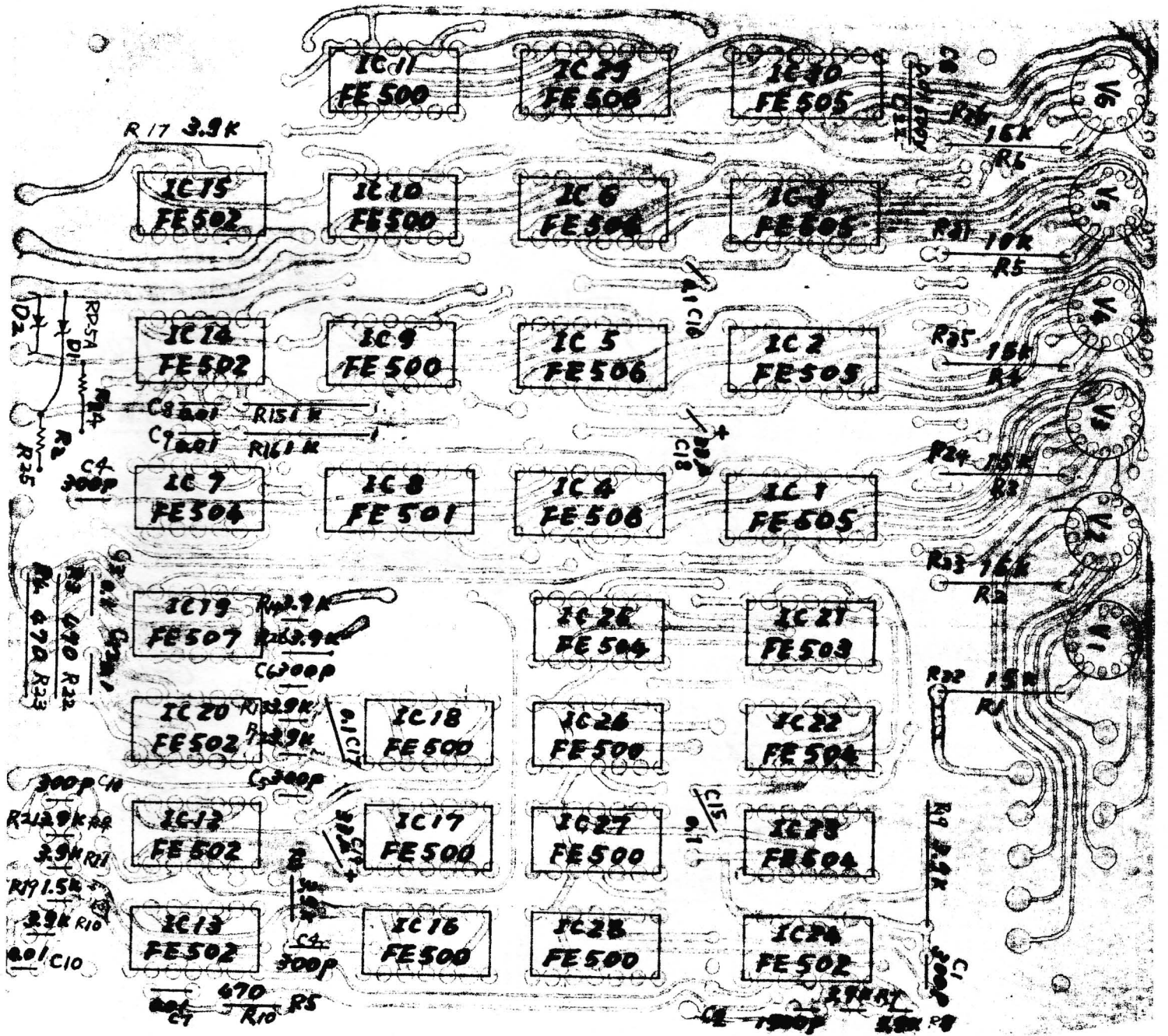

FEP-510
DIGITAL COUNTER

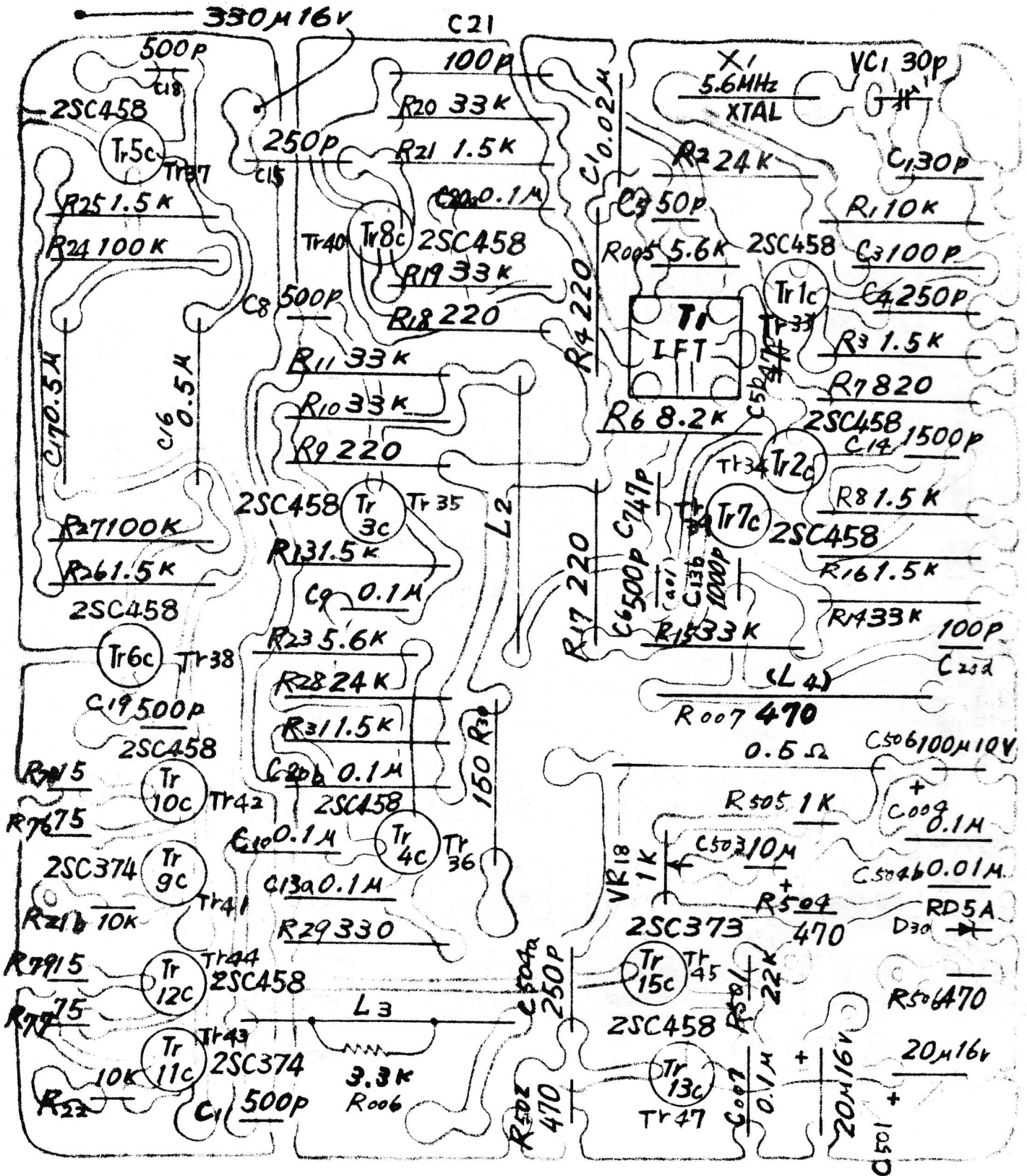

FEP-511

5.6 MHz OSCILLATOR /
UPPER AND LOWER LIMIT LIGHTS

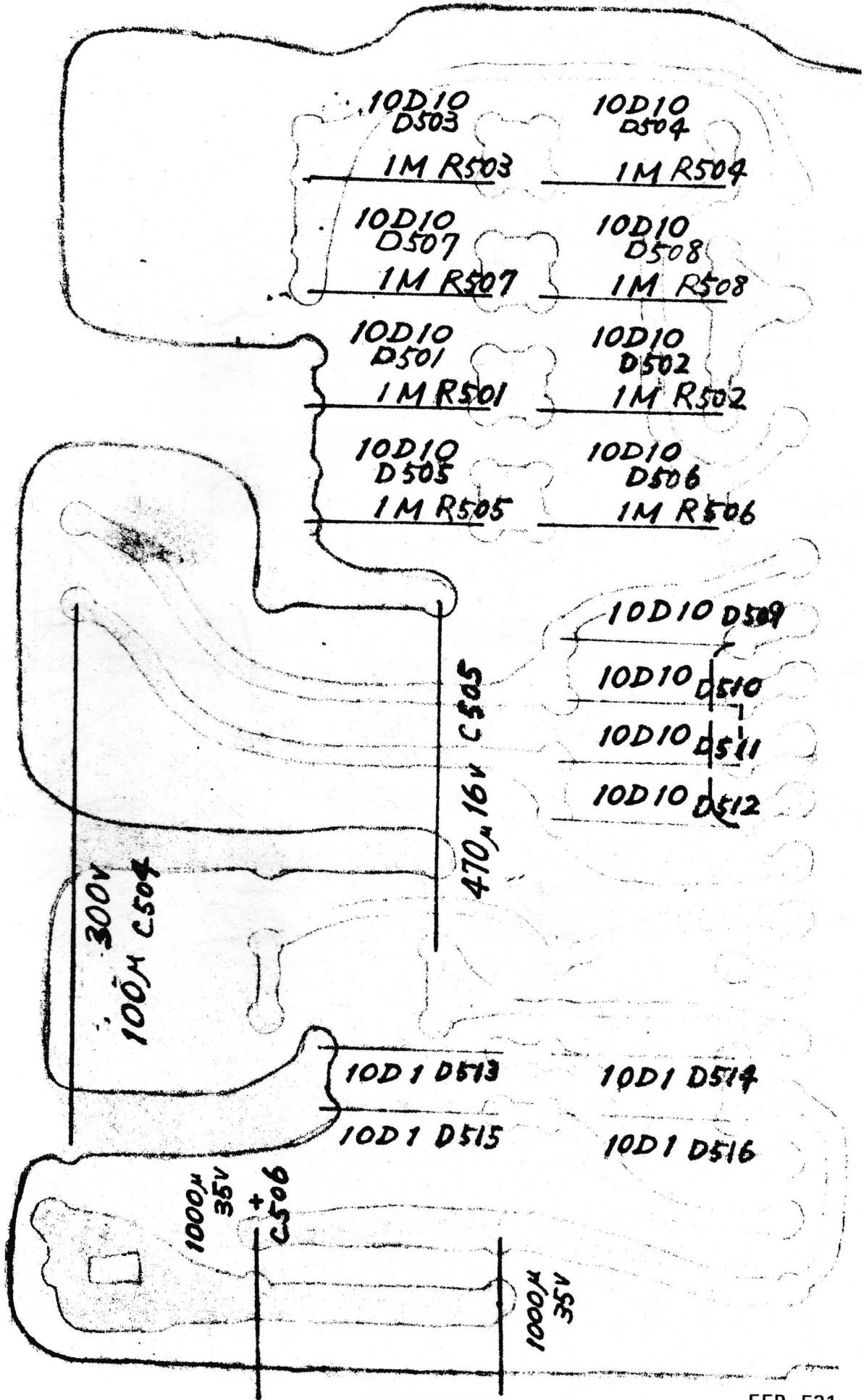

FEP-531

P/S HIGH-LOW
VOLTAGE RECTIFIERS

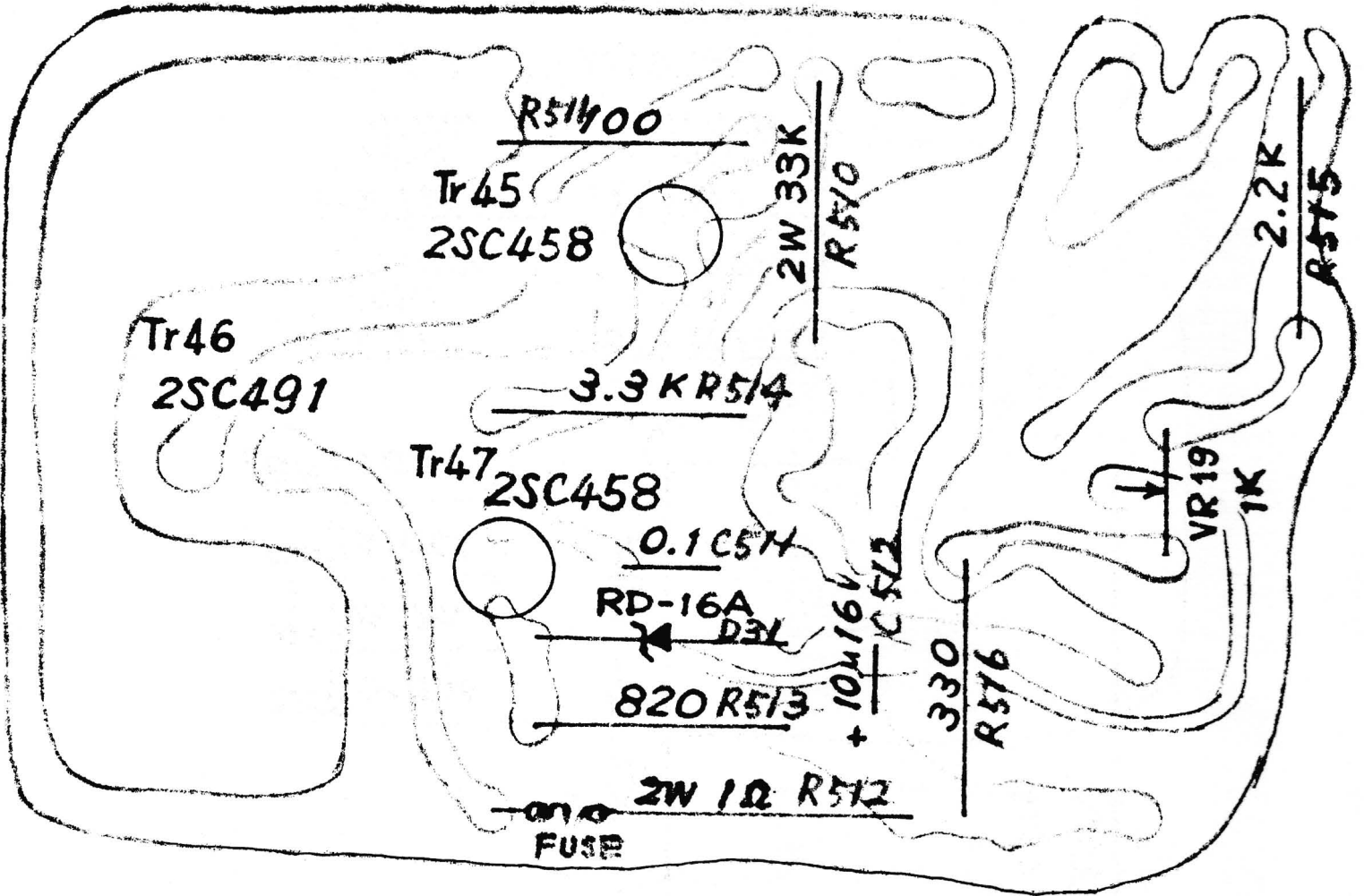

FEP-532
20V REGULATOR

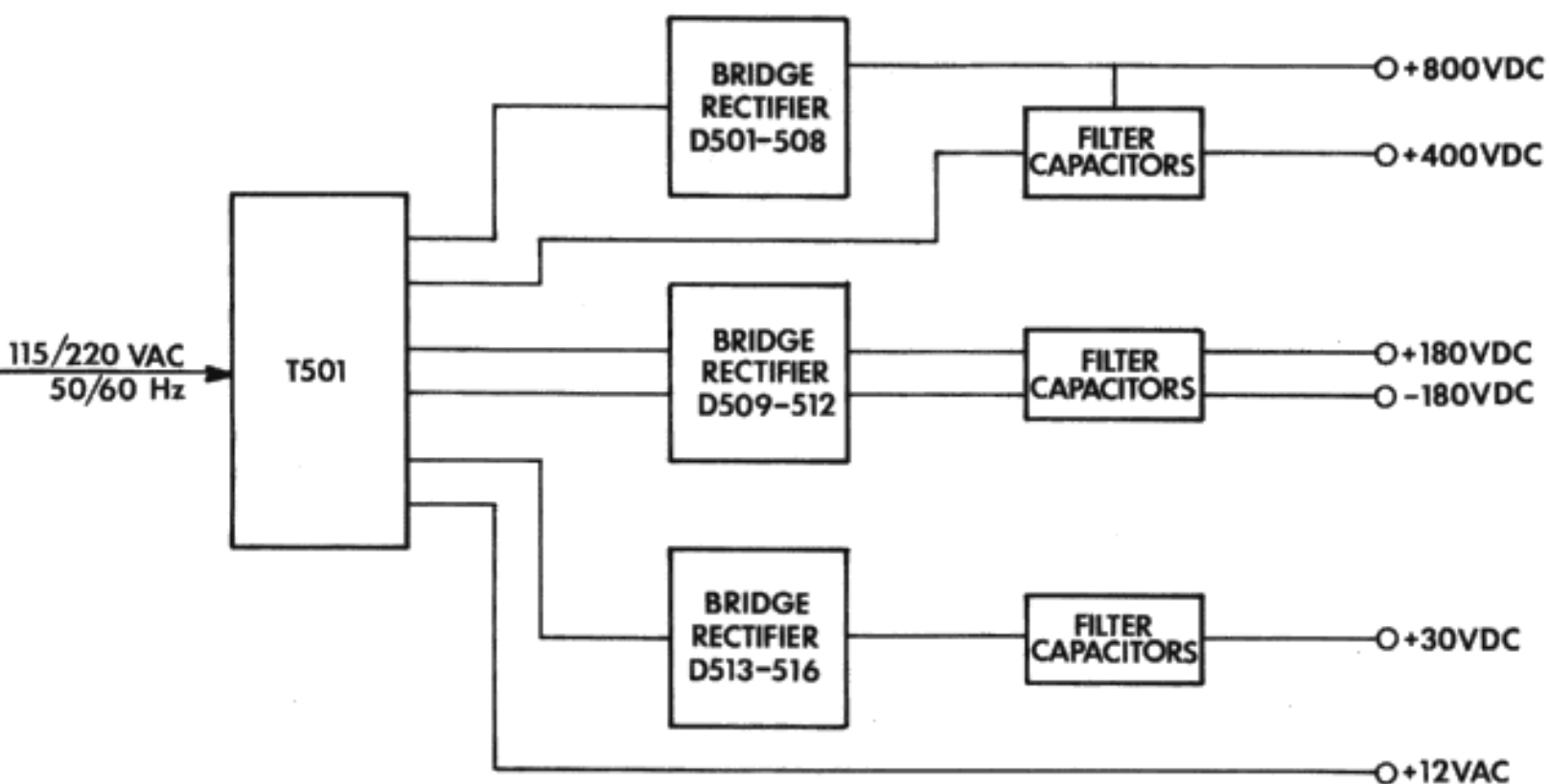

Sideband Engineers SB-36 Power Supply

NoobowSystemsLab. Tomioka, Japan 2003

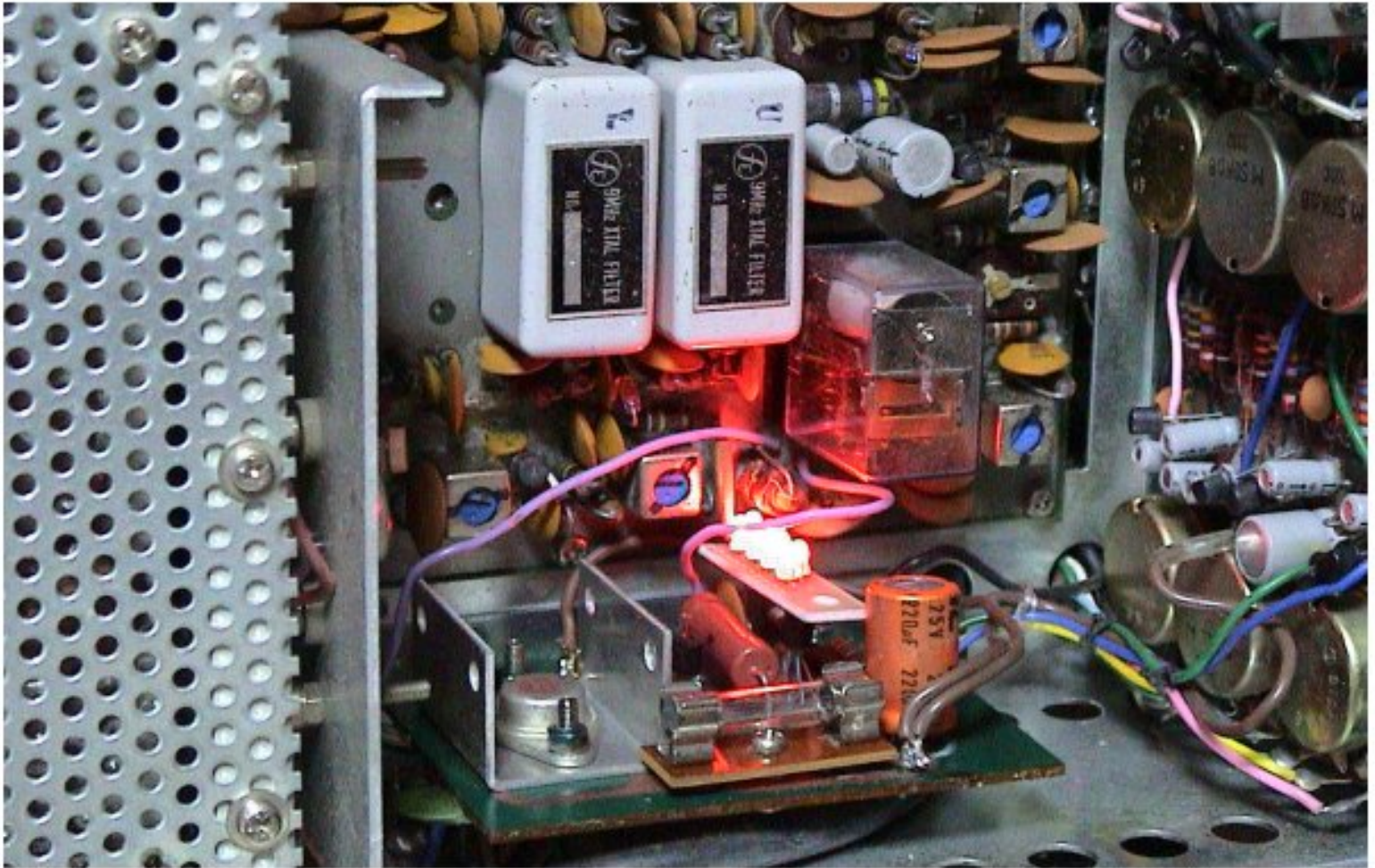

**SB-36 DC20V Regulator Board
with Voltage Reference using LEDs**

NoobowSystemsLab. Tomioka, Japan 2003

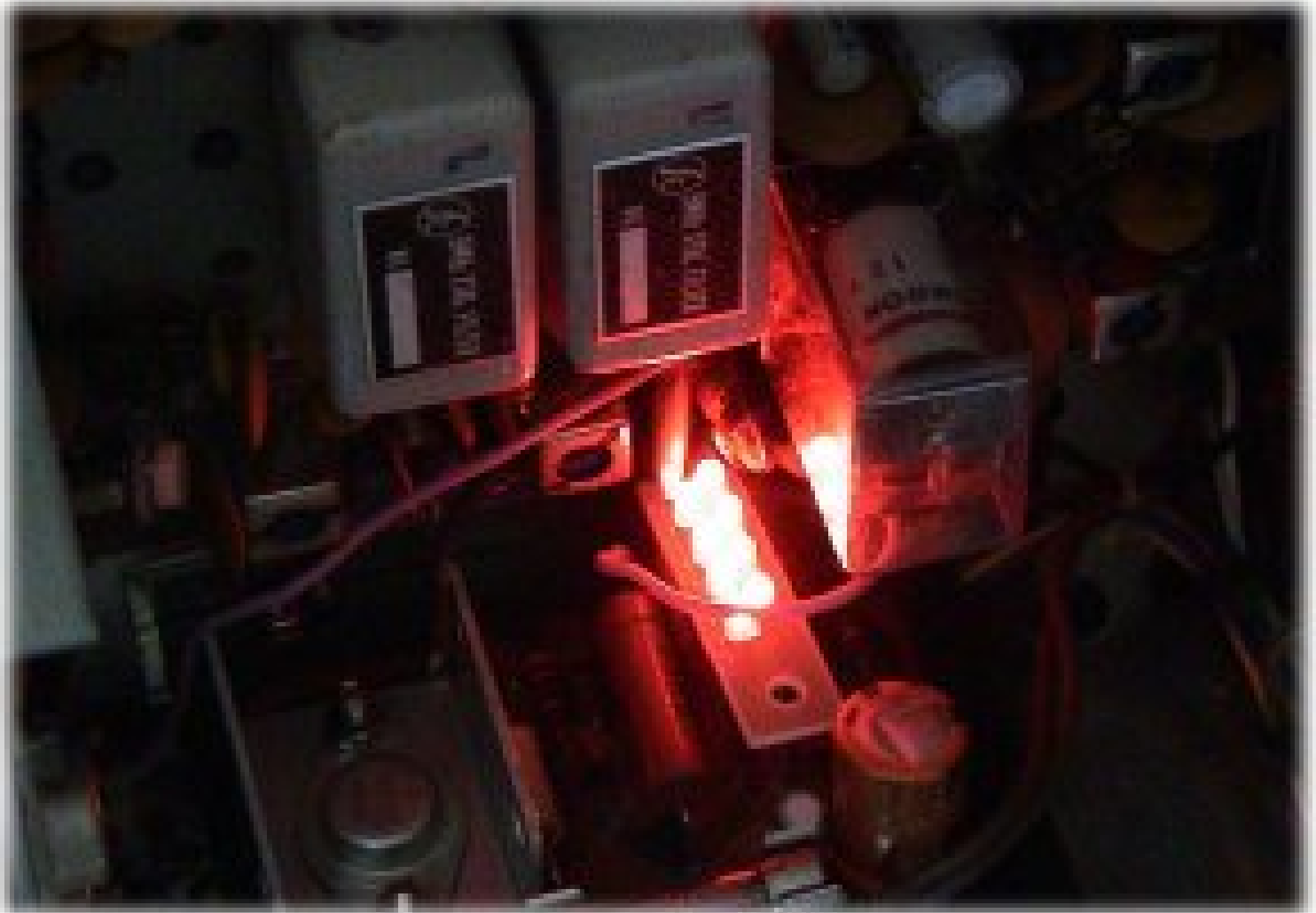

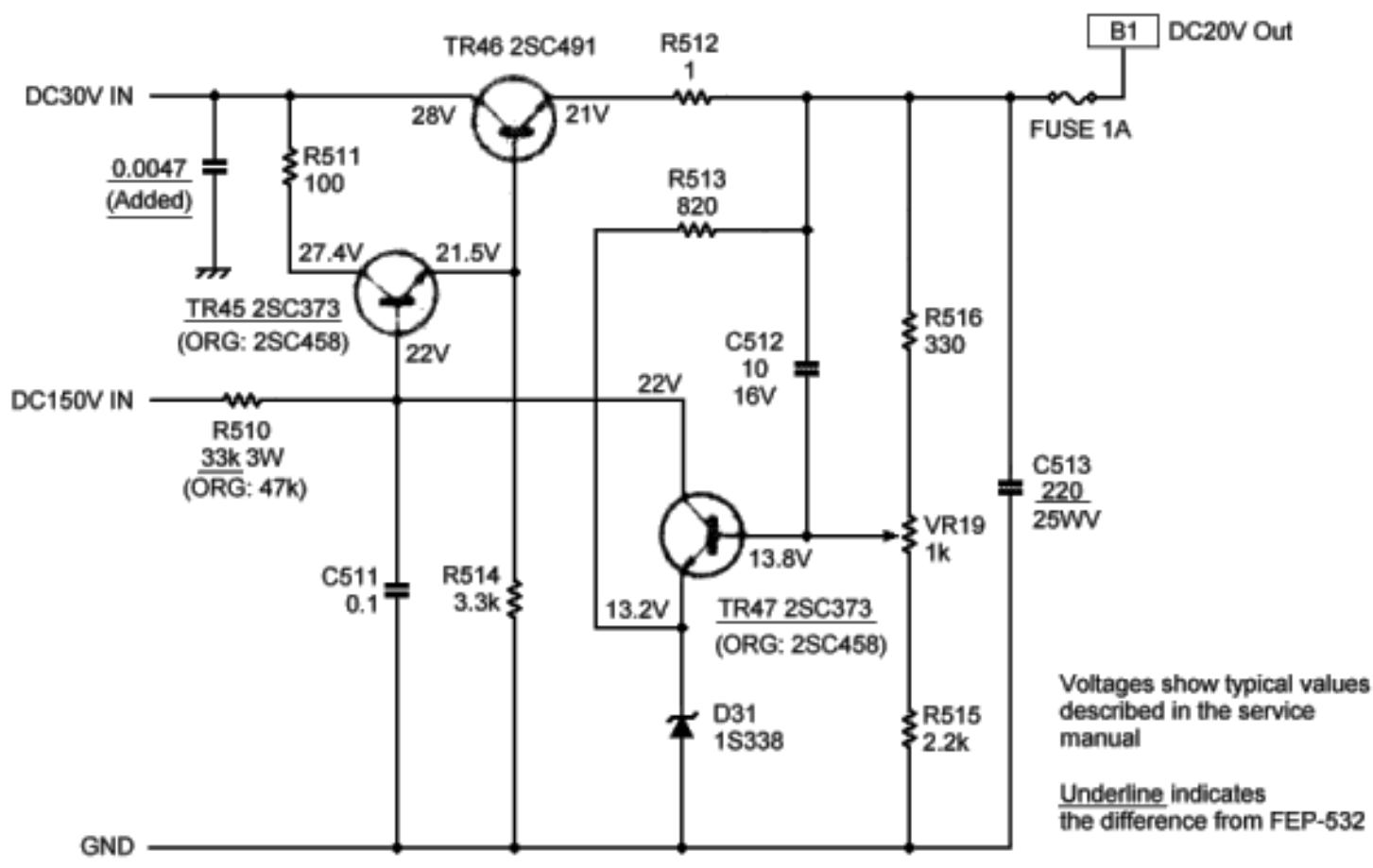

SideBand Engineers SB-36 FEP-532A DC20V Regulator Board

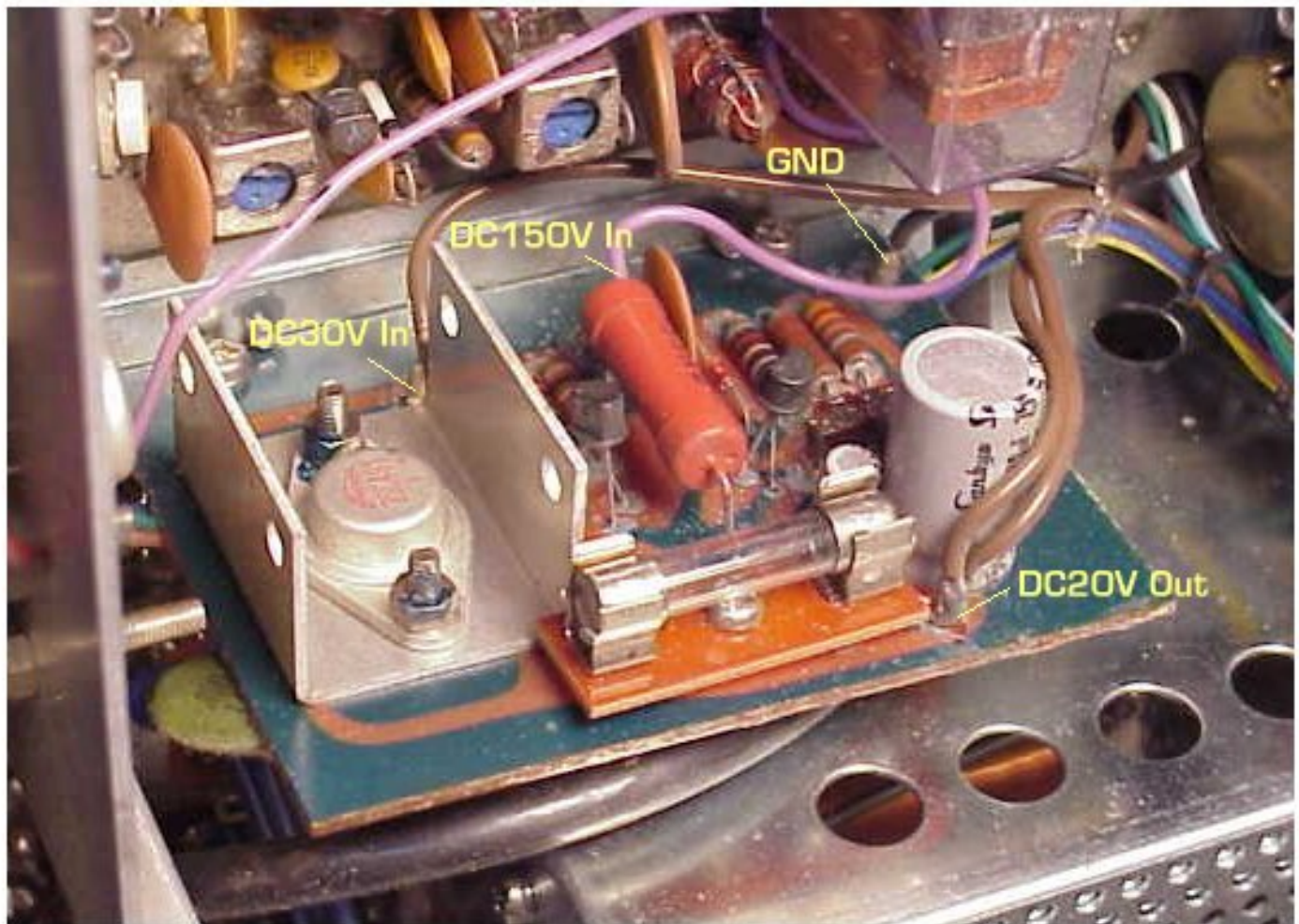

**SideBand Engineers SB-36
FEP-532A DC20V Regulator Board**

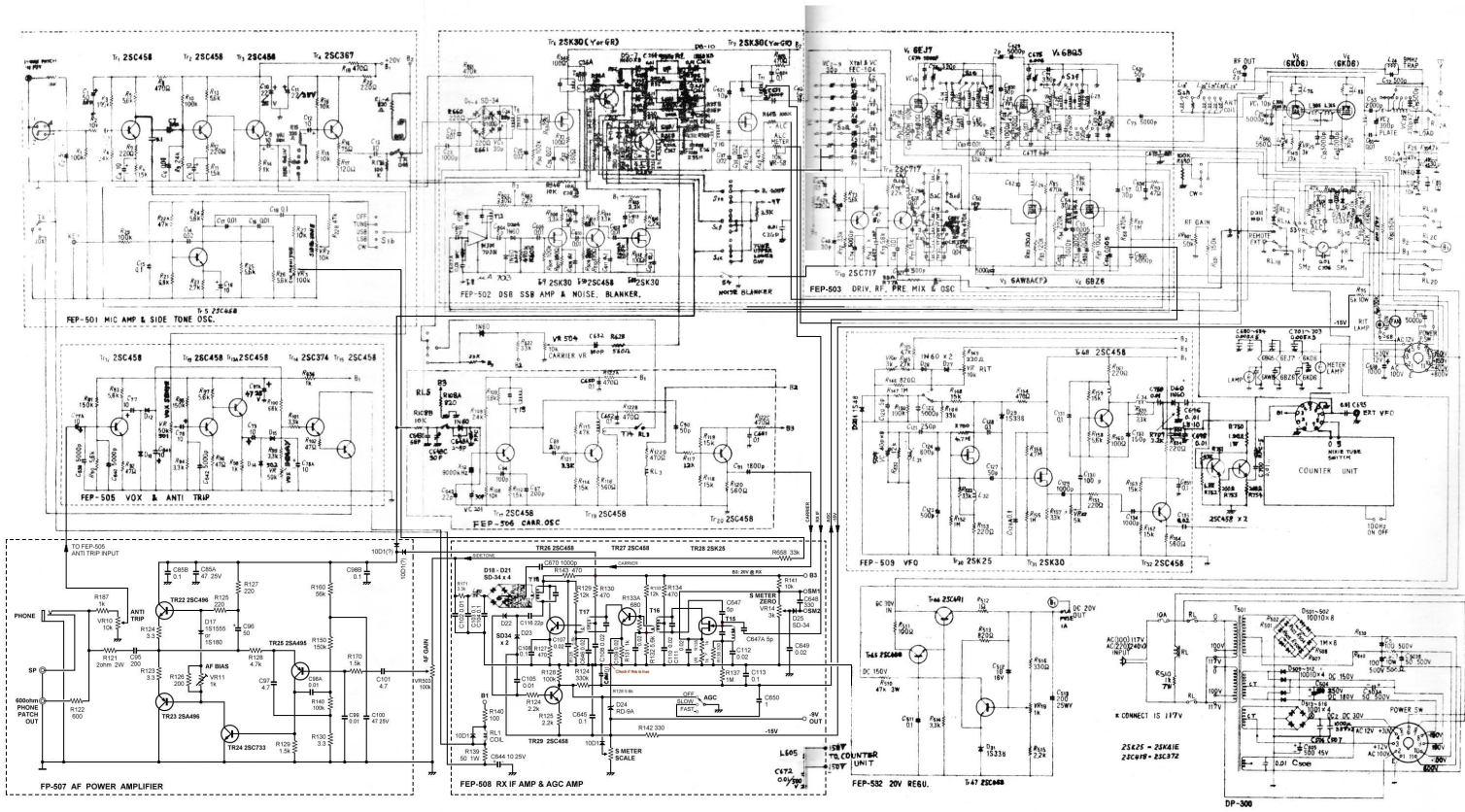

UNIT NAME: ARIAL 12pt Bold
 DEVICE NAME: Arial Sp1 Bold

LINEAR SYSTEMS SBE SB-36 SCHEMATIC DIAGRAM

2007-05-07 Release started
 2009-11-20 Preliminary release.

NOOBOYSYSTEMS LAB. TOMIOKA, JAPAN 2007, 2008

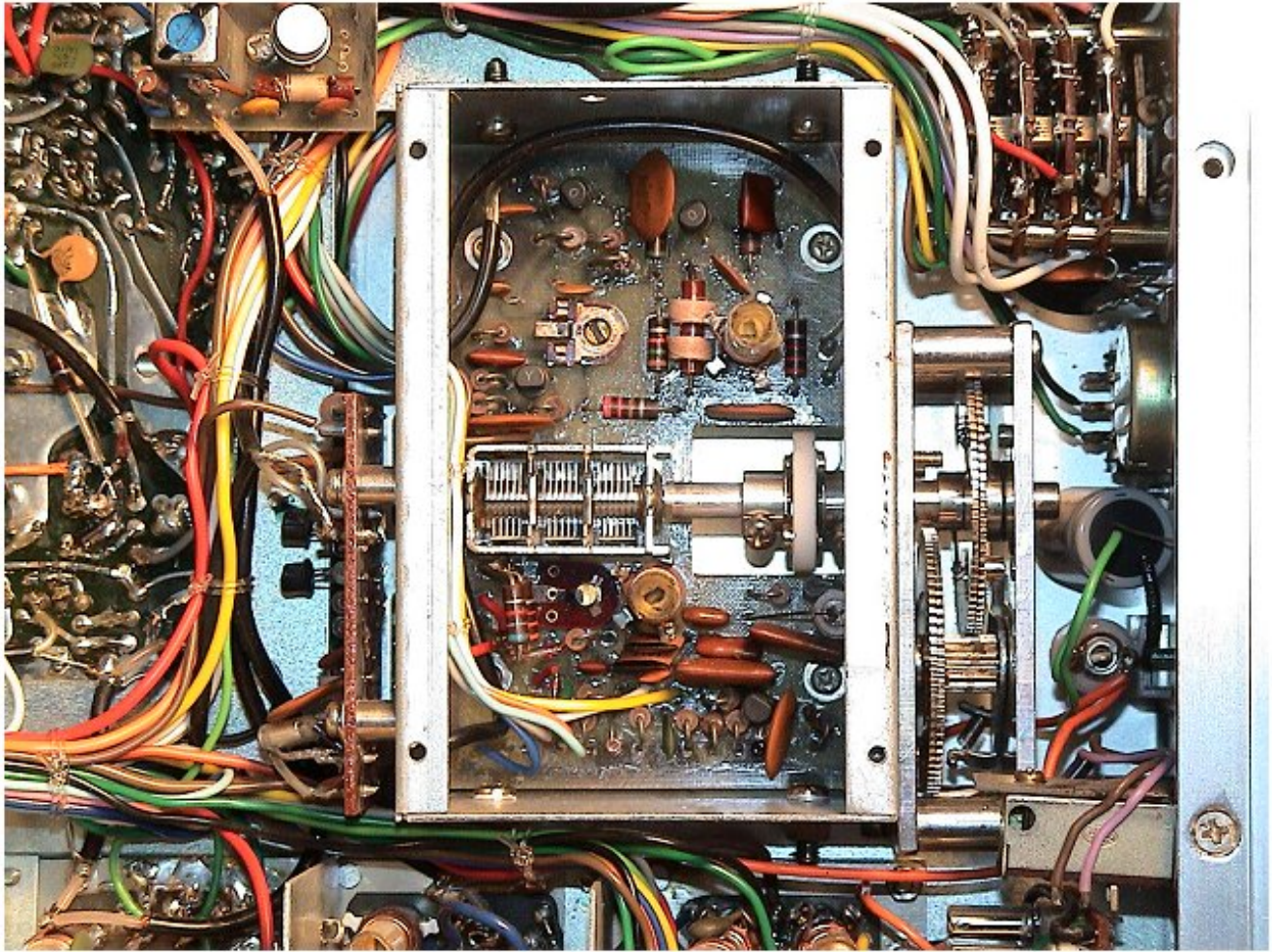

SBE SB-36 FEP-509 VFO UNIT