

LC53

“Z METER” CAPACITOR — INDUCTOR ANALYZER

Operation, Application, and Maintenance Manual



SENCORE
... the electronic instrument "analyzer people"

3200 SENCORE DRIVE, SIOUX FALLS, SOUTH DAKOTA 57107 • (605) 339-0100

TABLE OF CONTENTS

SAFETY PRECAUTIONS Inside Front Cover

SIMPLIFIED OPERATIONS 4

DESCRIPTION

Introduction 6
 Features 6
 Specifications 6
 Controls 8
 Supplied Accessories 10
 Optional Accessories 10

OPERATION

Introduction 12
 Power Connection 12
 Fuse Replacement 12
 Test Leads 12
 Test Lead Mounting Clip 12
Capacitor Testing
 Special Notes on Capacitor Testing 13
 Capacity Measurement Accuracy 13
 To Eliminate Lead Capacity 14
 Checking Capacitors Below 2 pF 14
 Interpreting "Z METER" Value Readings 14
 Testing Large Screw Terminal Lytics 15
 Checking Capacitors for Leakage 15
 Ceramic, Paper, Mica, and Film Types 16
 Aluminum Lytics 16
 Tantalum Lytics 16
 Leakage Charts 17
 Identifying Capacitor Types 17
 Tantalum Lytics 17
 Ceramic Discs 18
 Film Types 18
 Testing for Dielectric Absorption 18
 Reforming Lytics on the "Z METER" 19
 Reforming Lytics with a Power Supply 19
Capacitor Testing Application Tips
 No Value Reading on Small Value
 Capacitors 20
 Leakage in Ceramic, Paper, Film, and
 Mica Capacitors 20
 Checking for Leakage Between Sections
 of a Multi-Section Lytic 20
 Large Fluctuations in Lytic Leakage
 Readings 21
 Leakage Measurements of Non-Polarized
 Lytics 21
 Lytics Sitting in Stock 21
 Low Value Lytics Used in High
 Frequency Circuits 21
 Intermittent Capacitors 21

Time Required to Obtain a Value
 Reading on a Capacitor 22
 Checking Ceramic Capacitors for
 Temperature Sensitivity 22
 Checking Film Type Capacitors for
 Temperature Sensitivity 22
 Testing Capacity of Silicon Diodes
 and Transistors 22
 Testing High Voltage Diodes 23
 Testing Silicon Controlled Rectifiers
 (SCRs) and TRIACS 23
 Testing SCRs and TRIACS for
 DC Latching 23
 Testing SCRs and TRIACS for AC Latch
 and Unlatch Conditions 24
 Determining the Length of RF Coaxial
 Cable 24
 How to Find a Short in a Coaxial Cable .. 25
 How to Find the Inductance Per Foot of
 Coaxial Cable 25

Inductor Testing

Checking Inductors for Inductance
 Value 26
 Balancing Out Lead Inductance 26
 Checking Coils Below 2 Microhenrys 26
 Open Winding in a Coil 27
 Checking Inductance In-Circuit 27
 Testing Inductors on Printed Circuit
 Boards 27
 Mutual Inductance 28
 Value Reading on High Resistance
 Coils 28
 Inductor Coding 28
 Checking Inductors for Good or Bad
 With the Ringing Test 29

Inductor Testing Application Tips

Quality Testing on General Coils
 and Transformers 30
 Peaking Coils 30
 Coils in Metal Shields 31
 Ferrite Core Transformers and
 Coils 31
 Testing Flyback Transformers and Yokes
 With the Ringing Test 31
 In-Circuit Quick Test 31
 Testing Yokes with the Ringing Test 31
 Testing Horizontal Yoke Windings
 for Good or Bad 32
 Testing Vertical Yoke Windings for
 Good or Bad 33

MAINTENANCE

Introduction..... 34
Access/Disassembly 34
Equipment Required for Calibration..... 34
Meter Calibration..... 34
Input Protection Relay Trip Point Adjust..... 35
Inductance Calibration..... 35
Ringing Test Calibration 35
Capacitor Calibration 36

APPENDIX

Capacitor Theory and the "Z METER" 38
Capacitor Color Code and Marking Charts..... 42
Glossary of Terms 46

SERVICE AND WARRANTY Inside Back Cover

SIMPLIFIED OPERATIONS

CAPACITOR TESTS

5. Read VALUE of capacitor in pF or uF on Display

9. Read LEAKAGE in microamps on Display

8. Push Button

4. Push button

7. Select desired voltage for Leakage test

6. Select LEAKAGE RANGE

2. Adjust for 000 readout while pushing Capacitor Value button.

1. Open test leads

3. Connect capacitor to test leads

Model LC53
105-130 VAC 50-60Hz 25 WATTS

INDUCTOR TESTS

5. Read VALUE of coil in uH or mH on Display

4. Push Button

8. Read RINGING TEST on display 10 or more indicates good coil.

6. Push Button

7. Rotate to Red positions for Yoke & Flyback ALL positions for coils

2. Adjust for 000 readout while pushing Inductor Value button

1. Short test leads

3. Connect coil, yoke, or flyback

Model LC53
105-130 VAC 50-60Hz 25 WATTS

Notes

DESCRIPTION

INTRODUCTION

The use of capacitors in electronics has dramatically increased in the past few years and the forecast is for even a greater usage. The transistor has given way to the IC, but due to the nature and construction of the capacitor and the inductor, these are not replaced with ICs. The more ICs that are used, the more capacitors and inductors that will be used. The tolerance of the capacitor used to be 20%, but today, you will find circuits having 5% tolerance capacitors as standard. The use of electrolytic capacitors has also drastically increased as well as the capacity range. Capacities of 10,000 uF can be found in many consumer electronic items. Now more than ever, the need to measure capacity value, leakage of the capacitor, inductor value and quality of the inductor has become very important. Without a good measure of these important parameters, proper circuit operation becomes more difficult. Sencore has met the challenge head-on with its all new, autoranging "Z METER", the LC53. Now capacitors can be checked for value and for leakage at the rated working voltage on a digital readout. Inductors can be checked for inductance and for quality with the patented Sencore ringing test. The LC53 is truly the first complete capacitor and inductor analyzer.

FEATURES

The Sencore LC53 "Z METER" features advanced Digital Logic circuits that provide autoranging of the meter when checking the values of capacity or inductance. Simply hook up the capacitor or the inductor, press the proper VALUE button, and read the value on the large digital readout.

The "Z METER" also checks capacitors for leakage with two selectable current ranges at the rated working voltage from 3 Volts to 600 Volts. An LED (located between the LEAKAGE button and the APPLIED VOLTAGE switch) will flash on and off as a safety reminder when the leakage test voltage is set to 50 Volts or above.

The Sencore patented ringing test checks coils, deflection yokes, and non-iron core transformers with an accurate check of good or bad. There are six switch selectable impedance matching positions to match the coil to the test circuit from 10 uH to 10 H. Good coils will show 10 or more ringing cycles on the digital display while bad ones will show less than 10.

A special LEAD ZERO control lets you balance out the capacity or inductance of the test leads for those accurate readings of the very small capacitors and coils that you may encounter. The "Z METER" is also protected against accidental application of voltages to the test leads by a front panel replaceable fuse and a special relay inside the instrument.

SPECIFICATIONS

DIGITAL READOUT

TYPE: .5", 7 segment LED.

ACCURACY: Function accuracy \pm resolution error.

RESOLUTION: 3 significant digits \pm 2 counts on 3rd digit (3½ digits on capacitors of 100,000 uF to 200,000 uF).

AUTORANGING: Fully automatic decimal placement. One or two place holding zeros added as needed (does not affect accuracy) to provide standard value readouts of uF, pF, uH, or mH.

RANGE INDICATORS:

Type: LED.

Operation: Controlled by the autoranging circuits.

CAPACITORS (Out of Circuit):

Dynamic test of capacity value determined by measuring one RC time constant when capacitor is charged to +5V through:

10 Megohms for 0-9000 pF.

10 Kilohms for 9000 pF-90 uF.

100 Ohms for 90-199,900 uF.

ACCURACY: \pm 1% of reading + resolution error.
 \pm 5% of reading + resolution error for caps over 1000 uF.

RANGE: 1.0 pF to 199,900 uF in 10 automatically selected ranges.

CAPACITOR LEAKAGE

ACCURACY: \pm 5% + resolution error.

RANGES: 0 to 99.9 uA and 0 to 9.99K uA in two switch selectable ranges.

VOLTAGES: 12 selectable DC voltages from 3 VDC to 10 VDC filtered and from 15 VDC to 600 VDC, non-filtered. Available at test leads only when LEAKAGE pushbutton is depressed. Capacitor is automatically discharged when button is released.

INDUCTANCE (In- or Out-of Circuit)

Patent pending dynamic test of inductance value determined by measuring the EMF caused by a constantly varying current through the coil under test. Current rates are:

10 mA/usec - 0 to 90 uH.

1 mA/usec - 90 to 900 uH.

.1 mA/usec - 900 uH to 9 mH.

.01 mA/usec - 9 to 90 mH.

1 uA/usec - 90 to 900 mH.

.1 uA/usec - 900 to 9,990 mH.

ACCURACY: \pm 2% of reading + resolution error.

RANGES: 1.0 uH to 9,990 mH in 6 automatically selected ranges.

RINGING TEST

Dynamic test of inductor quality determined by counting the number of cycles the inductor rings before reaching a preset damping point after a given exciting pulse has been applied. (US patent 3,879,749).

EXCITING PULSE AMPLITUDE: Approximately 7
Volts peak.

ACCURACY: ± 1 count from readings of 8 to 13.

ACCESSORIES (Supplied)

- 39G143 Test Leads *
- 39G144 Test Lead Adaptor
- 39G145 Test Button Hold Down Rod (2 supplied) \
- 64G37 Test Lead Mounting Clip
- 68G34 Allen Wrench
- 44G20 Spare 1 Amp Slo-Blo Fuse

ACCESSORIES (Optional)

39G85 Touch Test Probe

GENERAL

TEMPERATURE RANGES (Typical): Calibrated at 70°F. Rated accuracy range: 50-90°F. Operating range: 32-130°F.

POWER: 105-130 VAC, 60 Hz, 25 Watts.

TEST LEAD INPUT: Fuse protected with in-line 1 Amp 3AG Slo-Blo fuse.

SIZE: 6" x 9" x 11.5" (15.24 cm x 22.86 cm x 29.21 cm)

WEIGHT: 7.75 lbs. (3.56 Kg).

"Specifications subject to change without notice."

CONTROLS

1. **Front panel digital readout**, first three digits read the value of capacity, inductance, leakage current or ringing test values, last two digits are place holders and only indicate 0 on larger values of capacity, inductance, or leakage current so all readings are given as pF, uF, uH, or mH.

2. a. **Indicator LED**, lights up when capacitor reading is in picofarads (pF).
- b. **Indicator LED**, lights up when capacitor reading is in microfarads (uF).
- c. **Indicator LED**, lights up when capacitor leakage reading is in microamps (uA).
- d. **Indicator LED**, lights up when inductor reading is in microhenrys (uH).
- e. **Indicator LED**, lights up when inductor reading is in millihenrys (mH).

3. **IMPEDANCE MATCH switch**, rotated through the last 4 test positions when making the ringing test on yokes and flybacks and through all 6 positions when testing other inductors. A reading of 10 or more indicates a good inductor.

4. **Power ON-OFF switch**, controls the AC line voltage to the "Z METER".

5. **RINGING TEST pushbutton**, depressed when making the patented Sencore ringing test on inductors, yokes, and flybacks to check the quality. Use IMPEDANCE MATCH switch (3).

6. **Test Lead Input jack**. Unscrew jack for access to input protection fuse.

7. **Inductor VALUE pushbutton**, depressed when testing inductors for value of inductance.

8. **Capacitor VALUE pushbutton**, depressed when testing capacitors for capacity value.

9. **Leakage chart on pull out.**

10. **LEAD ZERO adjust**, used to balance out the small value of capacity or inductance in the test leads when making precise measurements of small values of capacity or inductance.

11. **LEAKAGE test pushbutton**, depressed when testing capacitors for leakage after the APPLIED VOLTAGE switch (14) has been set to the working voltage of the capacitor and LEAKAGE RANGE switch (13) is set to the proper value as indicated in the leakage chart (9).

12. **Caution indicator LED**, blinks when the APPLIED VOLTAGE switch (14) is set to 50 Volts or higher as a warning to the user. Voltage is only present on test leads when LEAKAGE button (11) is depressed.

13. **LEAKAGE RANGE switch**, used to select the desired range of capacitor leakage current, 0 to 100 uA or 10K uA.

14. **APPLIED VOLTAGE SWITCH**, used for selecting the desired test voltage when making capacitor leakage tests.

REAR PANEL

15. **Rear panel meter zero adjust**. Adjust to zero digital readout with all buttons out.

16. **39G145 Test Button Hold Down Rod mounting clip.**

17. **39G144 Test Lead Adaptor mounting clip.**

18. **Cord wrapper for storing AC line cord and test leads.**

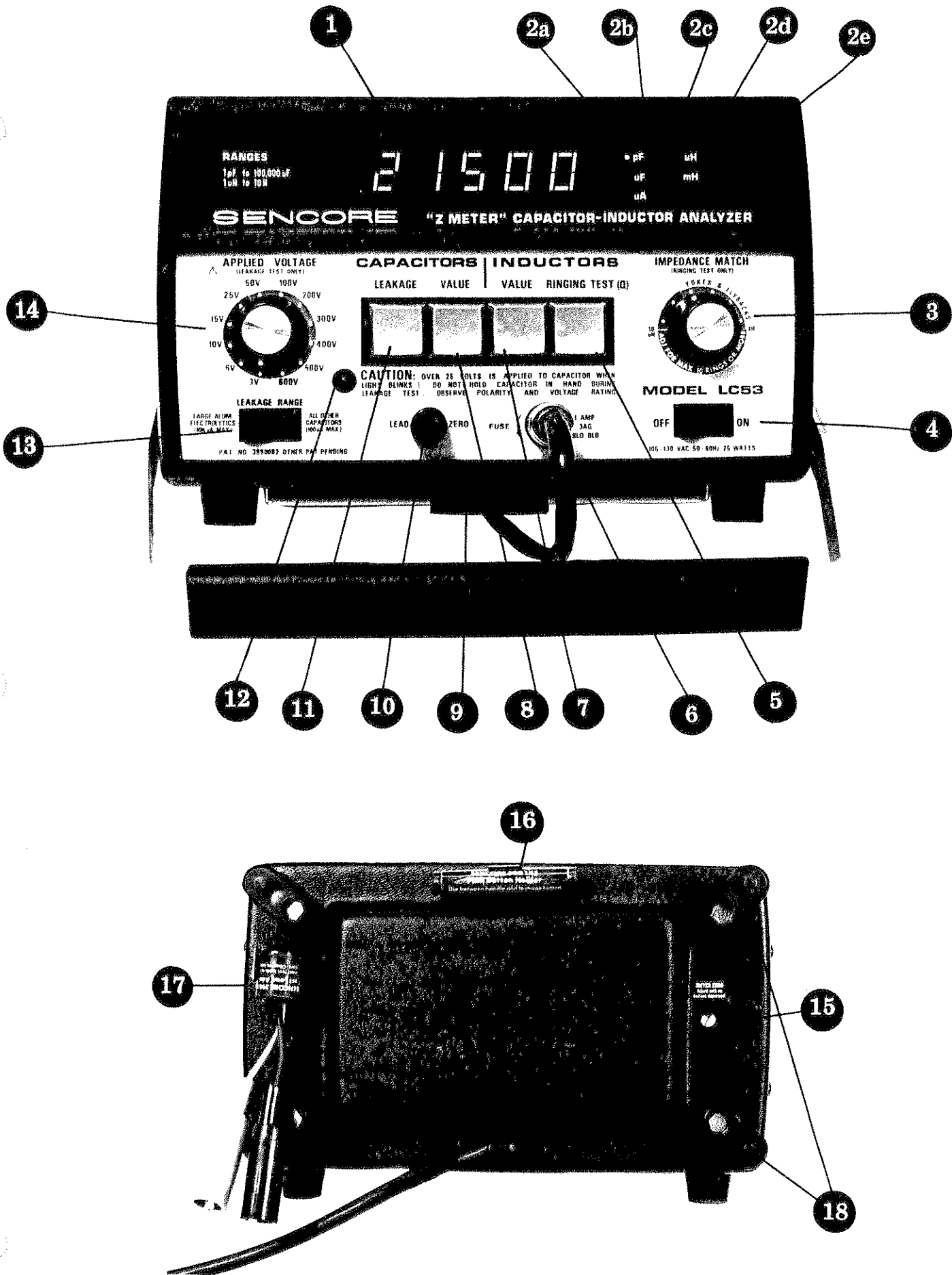

Fig. 1 — Location of controls and features of the LC53.

SUPPLIED ACCESSORIES

19. 39G145 Test Button Hold Down Rod. Used to hold LEAKAGE (11) button depressed when reforming lytics. (2 supplied — 1 in mounting clip, 1 in spare parts bag.)

20. 39G144 Test Lead Adaptor. Used to adapt test lead (21) clips to large screw terminals.

21. 39G143 Test Leads. Special low capacity cable with E-Z Hook® clips. Connect to Test Lead Input jack (6).

22. 64G37 Test Lead Mounting Clip.

23. 68G34 Allen Wrench. Used to tighten knobs.

24. 44G20 Spare Fuse. 1 Amp, Slo-Blo.

OPTIONAL ACCESSORIES

25. 39G85 Touch Test Probe for in-circuit testing of coils from foil side of P.C. board.

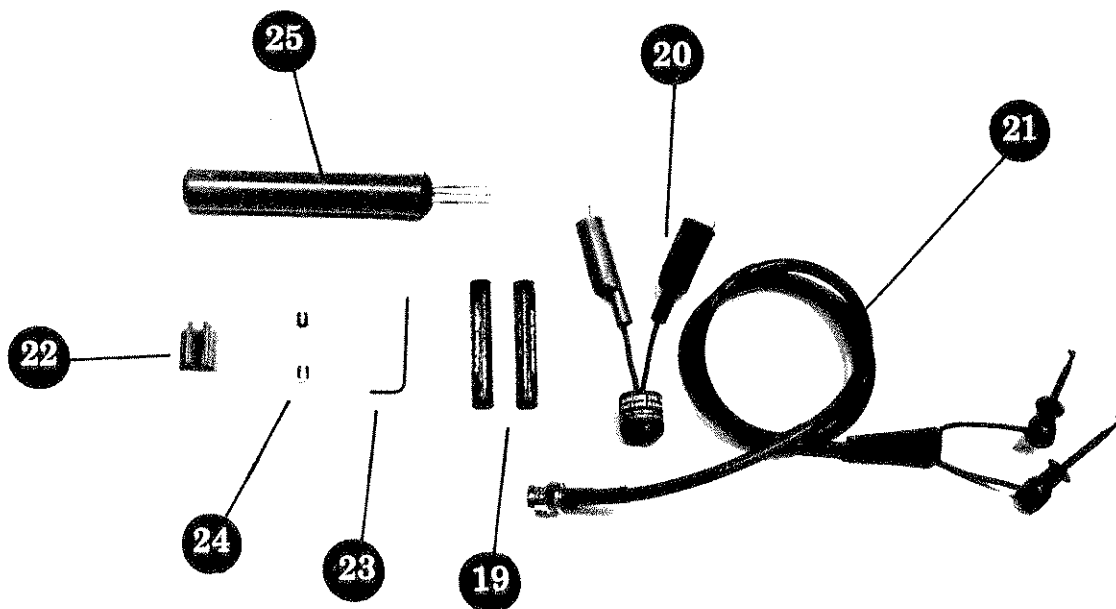

Notes

OPERATION

INTRODUCTION

Before using your LC53 "Z METER" for the first time, take a few minutes to read through the operations and applications section of the manual carefully to acquaint yourself with the features of the LC53. Once you are familiar with the general operations, most tests can be performed with the information provided on the LC53 front panel.

POWER CONNECTION

The LC53 is designed to be operated from 105-130 VAC (50/60 Hz). If 210-230 VAC operation is required, the unit may be modified (at additional cost) by the Sencore Service Department, 3200 Sencore Drive, Sioux Falls, SD 57107.

To operate the LC53 from the AC line:

1. Connect the AC line cord to a 117 VAC (or 220 VAC for modified units) outlet.
2. Turn the power switch on.
3. The LC53 is immediately ready to measure capacity or inductance. If precise measurements are to be made, the unit should be allowed to operate for at least 5 minutes to allow the circuits to stabilize.

FUSE REPLACEMENT

AC FUSE: The LC53 does not use an AC line fuse. The unit is protected by a special thermal switch in the power transformer. If the power transformer is overloaded, the thermal switch will open the primary, removing the voltage from the unit. Simply allow the unit to cool down and the thermal switch will close, applying power to the primary and allowing the unit to operate again. If your unit goes off, allow it to cool down and turn it on before any troubleshooting is started to allow the thermal switch to close if it has opened.

WARNING

Always replace the fuse in the test lead with a 1 Amp, 3 AG, Slo-Blo type. Any other type or current rating may cause internal damage to the unit and will void all warranties.

TEST LEAD FUSE: A 1 Amp, 3AG, Slo-Blo fuse is used in the test lead input on the "Z METER". This protects the input of the unit from voltage applied to the input accidentally. Replace with a 1 Amp, 3AG, Slo-Blo type only.

BLOWN FUSE CONDITIONS		
FUSE	TYPE	CONDITIONS
Test Lead Input	1 Amp 3 AG Slo-Blo	No Leakage readings Capacity reads a small negative value unchanged by LEAD ZERO adjustment Inductance shows flashing 888 with 0 following indicating open. No indication on Ringing Test.

TEST LEAD INPUT FUSE REPLACEMENT: The fuse for the test lead input is located behind the BNC input jack. The fuse holder may be removed by turning the BNC connector counter clockwise and unscrewing the connector until the fuse is free. The BNC connector of a set of test leads may be used as a "Wrench" to aid in the removal of the fuse holder. When replacing the fuse holder, make sure the holder is screwed in tightly to prevent the connector from turning when connecting and disconnecting test leads. Replace the fuse with a 1 Amp Slo-Blo 3AG fuse only.

OLD CAPACITOR IN HAND DURING POLARITY AND VOLTAGE RATING.

MODEL LC53

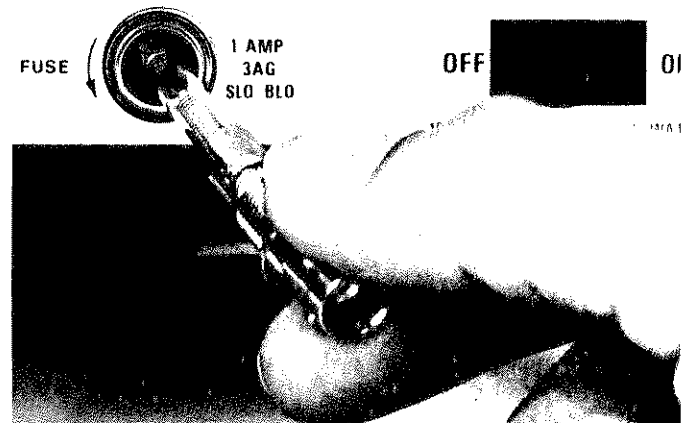

Fig. 2 — The 1 Amp, 3AG Slo-Blo fuse is located behind the test lead input jack.

TEST LEADS

39G143 TEST LEADS: The test leads (supplied with the meter) use a special low capacity cable. The use of any other cable will add extra capacity to the meter and may be out of range of the LEAD ZERO control. If the test leads ever need replacement, it is recommended that new leads (39G143) be ordered directly from the Sencore Service Department, 3200 Sencore Drive, Sioux Falls, SD 57107.

TEST LEAD MOUNTING CLIP

The special Test Lead Mounting Clip (64G37), included in the spare parts, may be mounted on the top of the "Z METER", on the side of the handle or on your work bench. The clip can then be used to hold the test leads

out of the way, but ready for use at any time. To mount the test lead clip, simply peel off the backing, place on the spot to be mounted, and press firmly.

NOTE: Do not mount the Test Lead Clip to the sides of the "Z METER" as it will interfere with the movement of the handle.

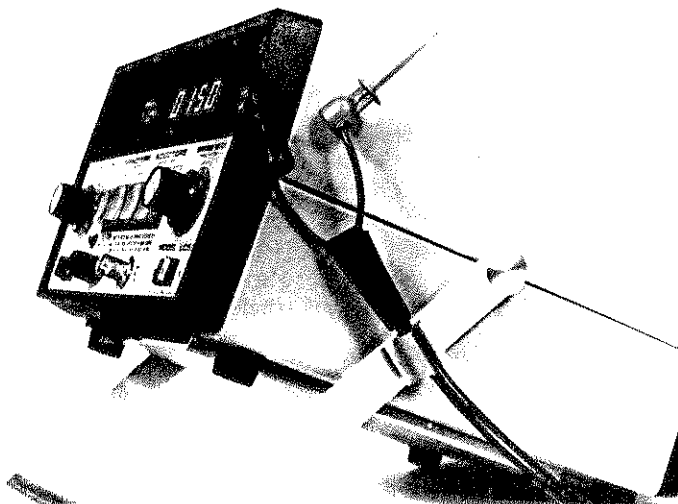

Fig. 3 — The special Test Lead Mounting Clip holds the test leads out of the way, but ready for use at any time.

CAPACITOR TESTING

The "Z METER" checks capacitors for their actual capacity with 6 automatically selected ranges. Simply connect the capacitor to the test leads, push the VALUE button under CAPACITORS and read the value on the digital readout.

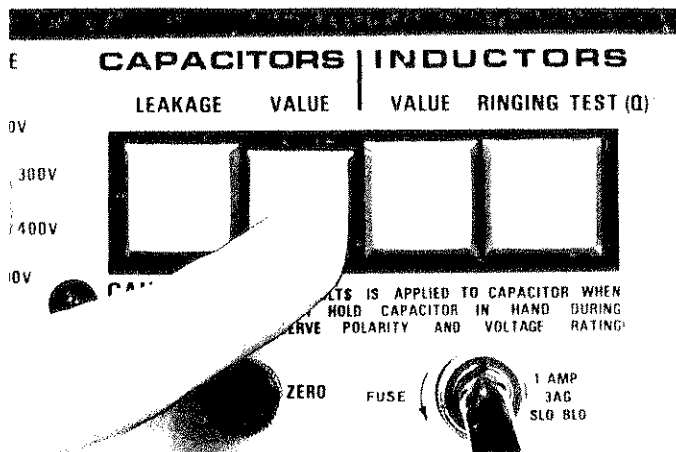

Fig. 4 — Just connect the capacitor to the test leads, depress the VALUE button, and read the capacity on the display; there are no range switches to set.

SPECIAL NOTES ON CAPACITOR TESTING:

1. Before operating the "Z METER", be sure to connect the AC line cord to a properly grounded AC outlet. The third wire ground on the "Z METER" provides more accurate readings of low level capacitors (below 1000 pF) with the third wire shielding. Defeating the third wire ground will not only result in lower accuracy value readings on capacitors below 1000 pF,

but void the warranty as well. If grounded outlet is unavailable, use a grounding adaptor and connect the third wire pigtail to a good earth ground such as a waterpipe.

2. The "Z METER" has been designed to give accurate readings of capacitor value out of circuit. Impedances found in the circuit will upset the "Z METER" readings. Capacitors cannot be checked in-circuit with any degree of accuracy or reliability with any known test method.

3. Remove the power from the circuit if a capacitor is to be checked that has one end removed but the other end still connected to the circuit. If the unit under test is AC operated, remove the AC line cord from the AC outlet. Whenever possible, remove the capacitor completely from the circuit.

CAPACITY MEASUREMENT ACCURACY

The Sencore "Z METER" has been designed to provide accurate measurements (within 1% of reading) of capacity using the most accurate method available. The "Z METER" measures the RC charging time of the capacitor with a precision charging resistor. This gives a true and accurate capacity measurement. The readings of the "Z METER" may or may not be the same as those of another instrument using a different measuring system. The bridge, for example, uses an AC signal and measures capacitive reactance, not the actual capacity. Two bridges with different frequency signals will give different capacity readings because the capacitive reactance changes with frequency. The higher the frequency, the lower the capacitive reactance and the lower the capacity reading. The Sencore "Z METER" will provide a true measure of capacity.

WARNING

When checking capacitors, connect the capacitor to the test leads before depressing the VALUE or LEAKAGE pushbutton.

To Check Capacitors for Capacity Value

1. Connect the test leads to the capacitor to be tested. Polarity of the test leads is only important if checking a polarized capacitor such as an electrolytic capacitor. When checking a polarized lytic, the red lead must be connected to the positive terminal.

2. Depress the VALUE button under the CAPACITORS section of the pushbutton switch.

3. Read the value of the capacitor on the front panel readout. The value of capacity will be in microfarads (uF) if the LED in front of the uF indicator is lit. The capacity is in picofarads (pF) if the LED in front of the pF indicator is lit.

NOTE: Most capacitor values will read very quickly, but extremely large electrolytic capacitors (over 50,000 μF) may take a few seconds to come up to a reading level. For example, a 50,000 μF will take about 5 seconds before a reading is seen on the digital readout. An extremely large (100,000 μF) computer-type lytic may take 10 seconds before the value is displayed on the readout. If the value does not read in the time listed above, then the capacitor is either shorted or very leaky. In either case, it is probably defective. Recheck the value again just to be sure.

This procedure provides accurate readings on the capacitors being tested. Small value readings (2 pF to 1000 pF) may be off slightly due to the capacity of the test leads. This capacity can be balanced out for extremely high accuracy readings with the LEAD ZERO control. The LEAD ZERO control is automatically switched out of circuit for capacity values above 10,000 pF.

TO ELIMINATE TEST LEAD CAPACITY

1. Place the test leads (with no capacitor connected) on the work area in such a way that they will not be moved when the capacitor to be tested is connected. Be sure that the test leads are not on a metal surface or near an AC power outlet or AC operated device. Stray AC may affect the reading of small values of capacitors.

2. Depress the VALUE button and adjust the LEAD ZERO control until the meter reads 00.0, with negative sign appearing occasionally.

3. Carefully connect the capacitor to be tested to the test leads. Depress the VALUE button and read the actual value of the capacitor on the meter.

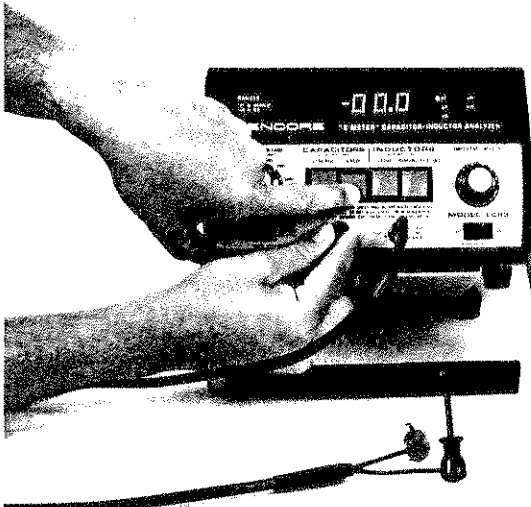

Fig. 5 — Test lead capacity can be zeroed out for extremely accurate readings on small value capacitors.

CHECKING CAPACITORS BELOW 2 PICO FARADS

The autoranging circuit in the “Z METER” will often show a “00.0” readout for capacitors less than 2 pF. This is due to the “zero window” that is necessary for

the autoranging circuit. Values below 2 pF can be read, however, by using the LEAD ZERO control to offset the meter zero.

To Read Capacitors Less Than 2 pF

1. Place the test leads (with no capacitor connected) on the work area in such a way that they will not be moved when the capacitor to be tested is connected. Be sure that the test leads are not on a metal surface or near AC power or an AC operated device.

2. Depress the VALUE button and adjust the LEAD ZERO control until the meter reads a positive number such as 2.0 pF. A negative number can be obtained on the readout but will give an incorrect reading.

3. Connect the capacitor to the test leads without disturbing their position on the work area.

4. Depress the VALUE button to obtain a reading on the meter. Subtract the setting of step 2 from the reading to get the actual value of the capacitor. For example, if the reading obtained was 2.6 and the setting in step 2 was 2.0, then the capacitor value is 2.6 minus 2.0 or 0.6 pF.

INTERPRETING “Z METER” VALUE READINGS

Some capacitor defects result in a reading much lower than the tolerance specified for the capacitor. Details on determining the tolerance of common capacitors are included in the Appendix section at the end of the manual. If the reading is outside this tolerance, the capacitor should be considered bad.

Some capacitors, especially aluminum electrolytics, may show an overrange indication (flashing 888). This reading indicates that the capacitor is defective.

The LC53 automatically displays the two most common capacitor values of picofarads (pF) and microfarads (μF). Capacitors from 1 pF to .089 μF will show as “pF”, and capacitors over .09 μF will show as “ μF ”. You may encounter some capacitors that are marked with the opposite multiplier. Some companies, for example, will mark the value of a given capacitor as “.047 μF ”, while others may mark the same type of capacitor as “4700 pF”. The following table will explain how to easily convert one reading to another. This conversion chart also appears on the pull-out chart on the bottom of the “Z METER” for your convenience.

CHANGE TO FROM	MICROFARADS	NANOFARADS	PICOFARADS
MICROFARADS		Move decimal 3 places right	Move decimal 6 places right
NANOFARADS	Move decimal 3 places left		Move decimal 3 places right
PICOFARADS	Move decimal 6 places left	Move decimal 3 places left	

Chart 1 — Capacitor multiplier conversion chart

TESTING LARGE SCREW TERMINAL LYTICS

Some lytics, especially in industrial applications, use rather large screw terminals rather than the conventional solder terminals. The 39G144 TEST LEAD Adaptor (supplied with the LC53) should be used to convert the small E-Z Hook® clips to large alligator clips to fit the large screw terminals. A special clip is mounted on the back of the LC53 to store the 39G144 when it's not in use.

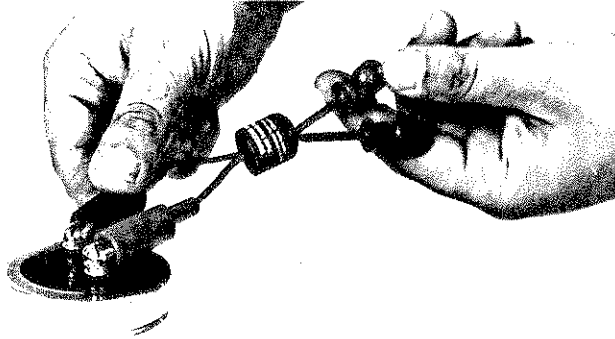

Fig. 6 — The 39G144 Test Lead adaptor allows even the large screw terminal capacitors to be connected to the LC53 for testing.

To Use the 39G144:

1. Connect the Red E-Z Hook® on the LC53 test leads to the red terminal of the 39G144 TEST LEAD ADAPTOR. Connect the Black clip to the other terminal.
2. Connect the Red alligator clip of the 39G144 to the positive screw terminal and the Black alligator clip to the negative terminal.
3. Test the capacitor in the usual manner.

CHECKING CAPACITORS FOR LEAKAGE

Capacitors will often read the correct value but exhibit leakage which may affect their operation in the circuit. The "Z METER" will check capacitors for this leakage at their rated working voltage up to 600 Volts. There are two leakage current ranges, 0 to 100 uA and 0 to 10K uA and 12 voltages from 3 Volts to 600 Volts DC. The voltage is applied to the test leads only when the LEAKAGE button is depressed. The capacitor is automatically discharged when the LEAKAGE BUTTON IS RELEASED.

WARNING

This instrument is to be operated by a technically trained person only — who understands the shock hazard of up to 600 Volts applied to the test leads during the capacitor leakage test. DO NOT hold the capacitor in your hand or touch the test leads or capacitor leads when making the leakage test with 50 Volts or more.

NOTE: The red area of the APPLIED VOLTAGE switch should be observed. Voltages in this area are 50 Volts and above and could cause a shock hazard. The blinking LED is an extra reminder that the APPLIED VOLTAGE switch is set to 50 Volts or greater. Always observe the red area of the switch in case the extra reminder LED is burned out.

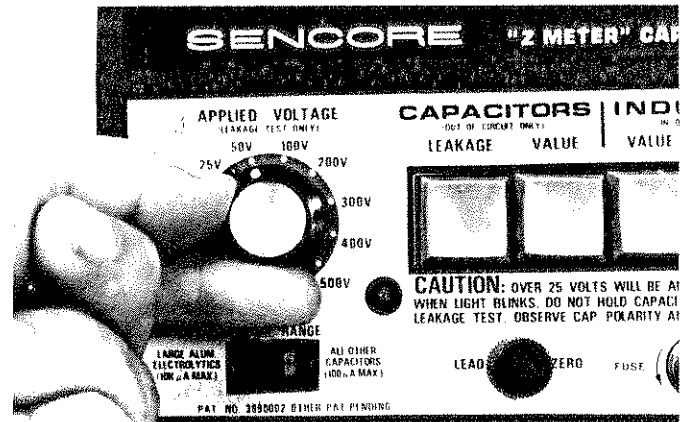

Fig. 7 — The LC53 can test capacitors for Leakage at the rated working voltage of the capacitor. Just set the APPLIED VOLTAGE switch, set the LEAKAGE RANGE, and depress the LEAKAGE button and read the leakage on the display in microamps.

To Check a Capacitor for Leakage

1. Connect the capacitor to be tested to the test leads. If the capacitor is polarized, such as an electrolytic capacitor, connect the positive end of the capacitor to the red lead and the negative end to the black lead.
2. Select the desired leakage range with the LEAKAGE RANGE switch. The ALL OTHER CAPACITORS (100 uA max) range is used for most small lytics, paper, mica, film, and ceramic capacitors. The LARGE ALUM. ELECTROLYTICS (100K uA max) range is used for large lytics. Consult the leakage chart to determine which range should be used. It is

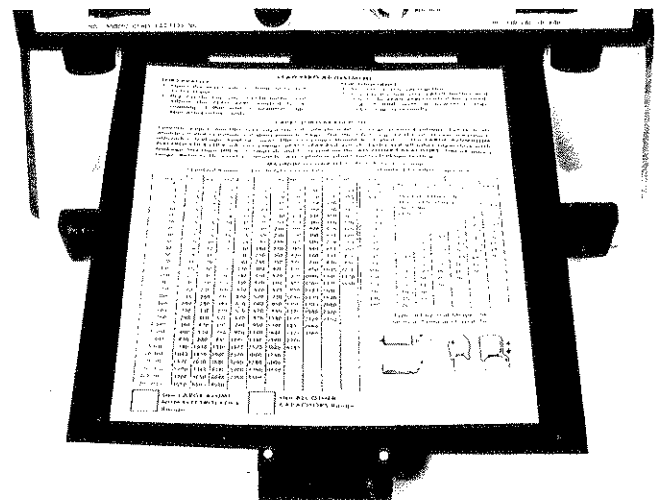

Fig. 8 — Simply consult the leakage chart on the pull out tab under the LC53 or the leakage chart in this manual for the maximum allowable leakage of aluminum and tantalum lytics.

best to start with the highest range (Large Aluminum Electrolytics) if you are not sure which range to use. If the display shows "000", then switch to the other range. You can switch ranges of the LEAKAGE RANGE switch while holding the LEAKAGE button in if you have selected the wrong range or merely wish to switch ranges.

3. Select the normal DC working voltage of the capacitor to be tested with the APPLIED VOLTAGE switch. If the normal working voltage of the capacitor falls between the ranges on the switch, select the next *lower* range. For example, if the working voltage of the capacitor to be tested is 35 Volts, select the 25 Volt position of the APPLIED VOLTAGE switch.

4. Depress the LEAKAGE button and read the value of leakage current in microamps on the display. Capacitors will take a specific amount of time to charge and give an accurate reading of the leakage current. Consult the type of capacitor you are testing in the following listing for time required to show a display.

CERAMIC, PAPER, MICA, AND FILM TYPES:

Use the ALL OTHER CAPACITORS position of the LEAKAGE RANGE switch when testing these capacitors for leakage. The leakage reading should take only 2 to 3 seconds for an accurate display. In some cases, with a very large value of capacity, a low leakage reading may appear in the first second or two and then change to 00.0. This is a normal condition and merely shows the capacitor is charging. If a reading is still present after about five seconds, the capacitor has excessive leakage and should be considered defective.

SPECIAL NOTE ON LOW VOLTAGE CERAMICS: Ceramic capacitors of 50 working volts or greater have a very high insulation resistance and should not show any leakage on the leakage test. Ceramic capacitors with a lower working voltage than 50 Volts have a much lower insulation resistance and may show leakage on the leakage test. The actual insulation resistance varies from manufacturer to manufacturer, but a general rule of thumb is: 16 working volt capacitors may show as much as 16 uA of leakage and be within tolerance. 25 Volt ceramic capacitors may show up to 2.5 uA of leakage. It is best to make a comparison test, if possible, with a known good capacitor and the suspect capacitor when in doubt. In most cases, these low voltage capacitors will only be used in circuits where this high leakage will not upset the circuit operation.

ALUMINUM LYTICS:

The aluminum lytic charging time will vary with the capacity and the applied leakage voltage. On larger lytics, the meter will overrange (showing flashing 888) until the charging current drops below 10 mA. The typical amount of time that the meter will overrange can be determined from chart 2. The display will usually begin at a high leakage reading and then drop with each update of the digital display. This shows the charging action of the capacitor through the impedance of the APPLIED VOLTAGE power supply

circuits. When a lytic is fully charged, the reading will change in small steps up and down showing the capacitor is charged. These small steps simply indicate that the capacitor under test is attempting to filter small changes in the AC power line voltage. It is not necessary, in most cases, to wait until the capacitor is fully charged to determine if it is good. Just depress the LEAKAGE button until the leakage drops below the maximum allowable level as shown on the chart in the manual or on the pull out table on the bottom of the "Z METER".

If the LARGE ALUM. ELECTROLYTIC (10K uA max) range is used first and the reading drops to 000, simply change the LEAKAGE RANGE switch to the ALL OTHER CAPACITORS (100 uA max) range while depressing the LEAKAGE button. Ignore the first two readings after changing ranges as the range switching changes the series impedance which in turn causes a momentary change in the charging rate.

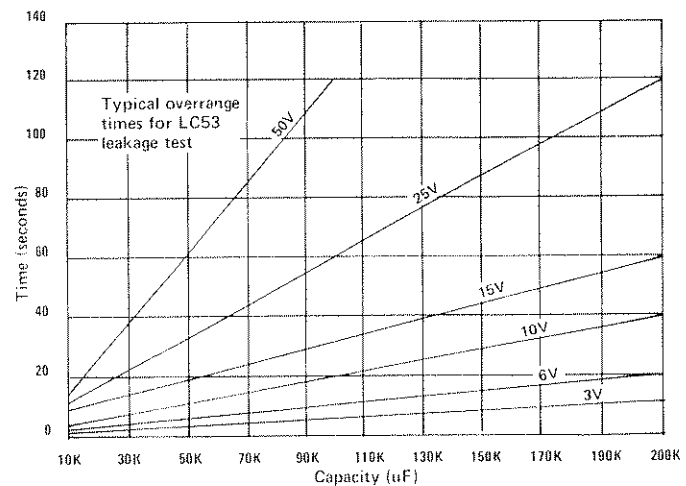

Chart 2 — Meter overrange time versus capacitor value and applied voltage.

NOTE: Some lytics may show a good value reading and a low leakage reading and be a questionable component. If the value is rechecked after the leakage is checked and the capacity is lower than first checked and begins to increase toward the original value, the lytic is exhibiting dielectric absorption. This generally occurs when the electrolite in the lytic begins to dry out. The capacitor does not completely discharge and the residual voltage reduces the charging time making the capacitor appear to be a smaller value. If a capacitor exhibits dielectric absorption, try reforming the capacitor as explained in "Reforming Lytics on the "Z METER" or "Reforming Lytics with a Power Supply" covered later in this manual. If the lytic still shows dielectric absorption after reforming, the lytic should be considered defective.

TANTALUM LYTICS:

Tantalum lytics have a much lower leakage compared to aluminum lytics for the same capacity and working voltage. Tantalum lytics should, in most cases, be checked on the ALL OTHER CAPACITORS range of the LEAKAGE RANGE switch. Tantalum lytics will give a leakage reading in a very short period of time, just a matter of 2 to 5 seconds.

LEAKAGE CHARTS

The following leakage charts are the same charts that you will find on the pull out tray on the LC53 "Z METER". They show the maximum allowable leakage of common lytics and tantalum lytics. Note that these figures are the worst case conditions as specified by the Electronics Industry Association (EIA) standards RS-345, and many lytics will show leakage values well below these figures.

Non-polarized lytics should be measured for leakage in both directions. Make the leakage test, then reverse the test leads and repeat the test. Some non-polarized lytics have one lead connected to the case. The allowable leakage on these types is twice that of a regular lytic of the same capacity and voltage rating in both directions.

MAXIMUM ALLOWABLE LEAKAGE (in microamps)																															
Standard Aluminum Electrolytic Capacitors										Standard Tantalum Capacitors																					
Capacity in μ F	3V	6V	10V	15V	25V	50V	100V	200V	300V	400V	Capacity in μ F	3V	6V	10V	15V	25V	50V														
1	5	5	5	5	5	5	5	10	15	20	1.5 and below	ALL CAPACITORS IN THIS AREA SHOULD SHOW NO LEAKAGE																			
3	5	5	5	5	5	8	15	30	45	200	2.2																1.5				
5	5	5	5	5	6	13	25	50	230	270	3.3																2				
10	5	5	5	8	13	25	50	270	330	380	4.7																1.5	2.5			
15	5	5	8	13	20	40	230	330	400	460	6.8																2	3.5			
20	5	6	10	15	25	50	270	380	460	540	10																2	2.5	5		
25	5	8	13	20	30	220	300	420	520	600	15																1.5	2.5	4	6	
30	5	9	15	25	40	230	330	460	570	660	22																1.5	2.5	3.5	5.5	10
35	6	10	18	28	45	250	360	500	620	700	33																2	3.5	5	8.5	14
40	6	12	20	30	190	270	380	540	660	760	47																1.5	3	5	7.5	12
50	8	15	25	40	210	300	420	600	730	850	68										2	4.5	7	11	15						
70	11	20	35	190	250	350	500	710	870	1000	100										3	6.5	10	16	20						
100	15	30	50	230	300	420	600	850	1040	1200	150										5	10	15	20							
150	22	45	230	280	370	520	730	1040	1300	1470	220										7	14	20								
200	30	200	270	330	420	600	850	1200	1470	1550	330										10.5	20									
250	40	230	300	370	470	670	950	1340	1640		470										15	22									
300	45	250	330	400	520	730	1040	1470	1800		680										20										
400	200	290	380	470	600	850	1200	1700	2080																						
500	230	330	420	520	670	950	1340	1900	2320																						
750	290	400	520	640	820	1160	1640	2320	2450																						
1,000	340	470	600	740	950	1340	1900	2680																							
1,500	400	570	740	900	1160	1640	2320	3280																							
2,000	470	660	850	1040	1340	1900	2700																								
5,000	740	1040	1340	1640	2120	3000	4240																								
10,000	1040	1470	1900	2320	3000	4240																									
20,000	1470	2070	2680	3290	4240	6000																									
50,000	1700	2340	4240	5200	6700	9500																									
100,000	3300	4650	6000	7350	9500																										
200,000	4650	6600	8500																												

■

Use LARGE ALUMI-NUM ELECTROLYTICS Range

□

Use ALL OTHER CAPACITORS Range

Chart 3 — Maximum allowable leakage for Aluminum and Tantalum lytics per EIA standards.

IDENTIFYING CAPACITOR TYPES

The capacitor has increased in use tremendously in the past few years. Many new types and improved versions are now in use. The following information is provided as a guide to aid in the identification of the type of capacitor and its value. The color code charts cover most of the variations that will be encountered. There may be others not covered here and in those cases, consult the manufacturer of the equipment for information.

TANTALUM LYTICS:

Tantalum lytics are being found in more electronic circuits than ever before. Its low leakage current and smaller physical size has made it a standout for solid-state circuits. The tantalum lytics can be made to tighter tolerances than aluminum lytics. Tantalums are not marked as such and the schematic generally does not indicate the lytic as a tantalum. The tantalum lytic is smaller (about one-half or less) than the same capacity and voltage aluminum lytic. The tantalum

comes in many sizes and shapes as shown in figure 9. Some use a color code like that shown in figure 9. Note that the color coding can show the positive lead. Some tantalums are marked with the value and a + on the positive lead. Other tantalums use the shape of the lead or a rounding of a corner to indicate the positive lead.

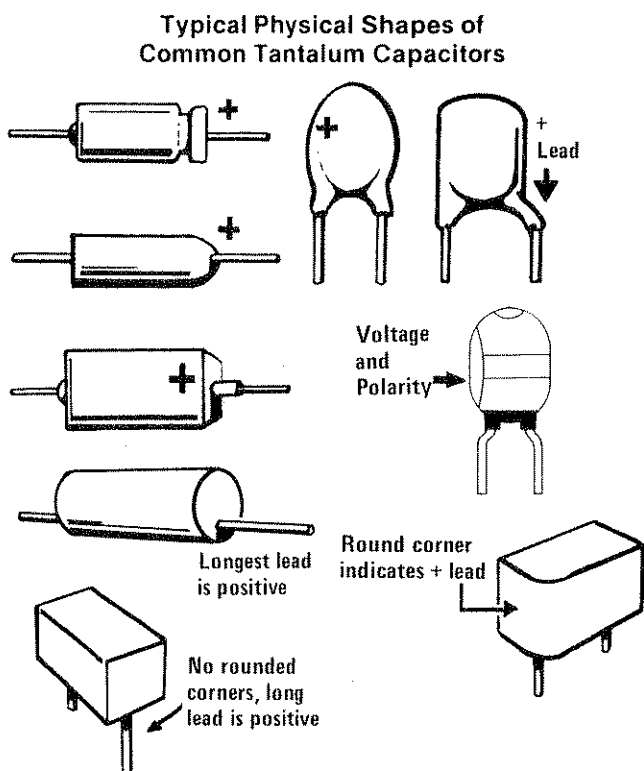

Fig. 9 — Tantalum lytics come in all sizes and shapes. The most common shapes are shown here for identification of the positive lead.

CERAMIC DISCS:

The ceramic disc is well-known and can be identified by its round shape and generally brown color. Some ceramic discs come in different colors such as blue and green due to a different coating material on the outside. Most ceramic discs are marked with the value and the tolerance. The most common working voltage (500 Volts) is generally not marked, but anything different is normally found on the capacitor body. There are other markings such as NPO, GMV, N1500, or similar. These are the temperature coefficients or how much the capacitor will change with a change in temperature. When replacing a ceramic disc, be sure to use the same exact type that was used in the original circuit. NPO stands for Negative-Positive-Zero or no change in capacity. GMV is Guaranteed Minimum Value and the actual value could be much higher. The letter N indicates that the capacity will decrease with an increase in temperature, and if you find one with a letter P, that one will increase in capacity with an increase in temperature. Further information will be found in the section on "Capacitor Theory and the 'Z METER'" and in the Glossary at the back of the manual.

FILM TYPES:

These are the hardest to identify as to the type of film being used. The type of film is not generally marked and it could be any one of at least five types. On these capacitors, you will have to consult the manufacturer's service information for the correct type. It should be noted that a Mylar® capacitor is not a universal replacement for any film type capacitor. Each film has different characteristics and must be replaced with the same type of film used in the circuit. This is especially true in those areas of schematics that are designed as "Safety Critical".

TESTING FOR DIELECTRIC ABSORPTION

Dielectric absorption is the inability of a capacitor to completely discharge to zero. This is sometimes called "battery action" or "capacitor memory" and is due to the dielectric of the capacitor retaining a charge. All capacitors have some dielectric absorption, but electrolytic capacitors have the highest amount and will often affect circuit operation if it becomes excessive. You can check lytics for dielectric absorption during the normal test for capacitor value and leakage by simply rechecking the value of the capacitor after the leakage test in the following manner.

1. Connect the capacitor to the test leads and test for the capacitor value in the normal manner. Note the value of the capacitor.
2. Test the capacitor for leakage at the rated working voltage of the capacitor. Allow the leakage current shown on the display to drop to the maximum allowable leakage or below as shown on the leakage chart in the manual or on the pull out tab under the meter.
3. Release the LEAKAGE button and allow the display to drop to 000 and then immediately depress the VALUE button and note the capacitor reading.

- a. If the capacity reading is within 5% of the original value and the reading increases slowly upward toward the original value, or there is no difference in the readings, the capacitor has very little dielectric absorption and is good.
- b. If the value reading difference is greater than 5% but less than 15%, the capacitor may require reforming as described later. Some of the dielectric oxide has deteriorated and reforming the lytic may bring it back to a useful life. Recheck for dielectric absorption often attempting to reform the capacitor.
- c. If the value reading difference is greater than 15% and the reading changes upward rapidly toward the original value, the capacitor has excessive dielectric absorption. Electrolytic capacitors exhibiting this much dielectric absorption may be reformed in some cases. If the capacitor exhibits similar dielectric absorption after reforming has been attempted, it should be replaced as it will give trouble in the circuit.

NOTE: If a mica or film type capacitor shows any dielectric absorption, it can be considered "bad" and should be replaced.

REFORMING LYTICS ON THE "Z METER"

Aluminum lytics will often show low value or high leakage if they have been sitting on a shelf for a long period of time. Generally any aluminum electrolytic capacitor sitting on the shelf for over one year will show up in this manner. This is caused by a loss of some of the oxide coating that forms the dielectric of the capacitor. In many cases, the oxide coating may be reformed with the application of a DC voltage for a period of time. The "Z METER" can reform the dielectric material by using the same DC power supply that is used for leakage testing. Reforming may require more than an hour before the capacitor returns to its normal condition. The 39G145 TEST BUTTON HOLD DOWN ROD is included with the "Z METER" to hold the LEAKAGE button down for reforming lytics. A special clip is mounted on the rear of the instrument for storage of the 39G145 when it is not in use.

WARNING

Use the 39G145 with extreme caution! Do not touch the test leads or the capacitor leads while the 39G145 is being used. Make sure that the capacitor being reformed will not touch any metal or come in contact with any metal object while it is being reformed. The voltage from the APPLIED VOLTAGE switch is present on the test leads when the LEAKAGE button is depressed.

NOTE: Observe the red area on the APPLIED VOLTAGE switch. This indicates a voltage of 50 to 600 Volts DC and can be dangerous. The special LED will also blink on and off to indicate that the APPLIED VOLTAGE switch is set to 50 to 600 Volts but rely on the red area of the switch in case the LED burns out.

To Use the 39G145 Test Button Hold Down Rod:

1. Connect the lytic to be reformed to the test leads observing polarity.
2. Select the proper voltage with the APPLIED VOLTAGE switch. Observe the above warning when using 50 Volts or more.
3. Depress the LEAKAGE button, and while holding the button in, place the 39G145 on the button. Bring the handle to the front of the meter and wedge the 39G145 between the handle and the LEAKAGE button so that the rod holds the LEAKAGE button depressed.
4. After the capacitor has been reformed for at least one hour, it should be allowed to discharge and sit for about 30 minutes. Then recheck the value and the leakage to see if the reforming processed has improved the capacitor.

SPECIAL NOTE: This method of holding the LEAKAGE button in provides a greater degree of safety than a "latching" type of switch. Always observe extreme caution when you see the handle in front of the switches as this will tell you voltage is being applied to the test leads and capacitor. Never attempt to operate any other function pushbuttons when the 39G145 is being used.

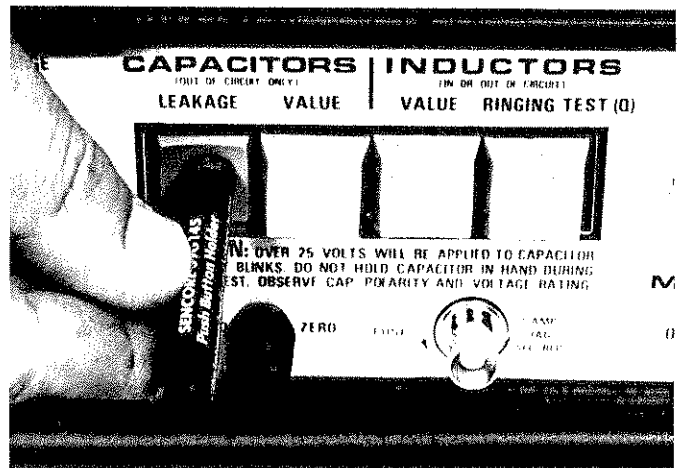

Fig. 10 — The 39G145 Test button Hold Down Rod can be used to keep the LEAKAGE button depressed when reforming a lytic on the "Z METER".

REFORMING LYTICS WITH A POWER SUPPLY

A separate DC power supply may be used to reform a capacitor. The power supply must have a voltage output equal to the capacitors working voltage, and should be adjustable from zero to allow the voltage to be increased slowly. The power supply should also have a DC current meter or an external meter must be used to monitor the charging current.

CAUTION

Always use a series limiting resistor when applying voltage from an external power supply. This will prevent the capacitor from charging too fast which may cause permanent damage to the capacitor.

WARNING

Voltages from 50 to 600 Volts can be dangerous. Do not touch the leads from the power supply or the leads of the capacitor. Do not allow the capacitor to come in contact with metal or any metal object while the voltage is being applied. A warning sign should be placed on or next to the unit while the capacitor is being reformed.

To Use the External Power Supply to Reform Lytics:

1. With the power supply turned OFF, connect the positive power supply terminal, through a 1000 Ohm, 5 Watt resistor and the external current meter (if required) to the positive terminal of the lytic to be reformed.

2. Connect the negative terminal of the power supply to the negative terminal of the lytic.

3. Set the output voltage control on the power supply to minimum.

4. Turn the power supply to ON and slowly increase the voltage while watching the current meter. Do not allow the charging current to go above 50 mA. If the meter reads higher than 50 mA, stop increasing the voltage until the current drops below this level. Then slowly increase the voltage again while watching the current meter until the DC working voltage of the capacitor is reached. Allow the capacitor to remain at its full rated working voltage for at least 30 minutes to one hour.

5. After one hour, turn the power supply off and allow the capacitor to discharge. After the capacitor has discharged for at least one hour, recheck the value and leakage on the "Z METER" to see if further reforming is necessary.

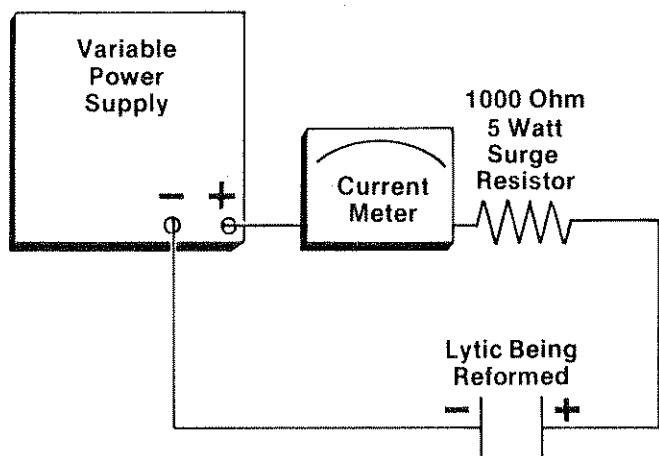

Fig. 11 — A lytic may be reformed with an external power supply being sure to use a series resistor and a current meter to monitor the reforming current.

CAPACITOR TESTING APPLICATION TIPS

NO VALUE READING ON SMALL VALUE CAPACITORS

A shorted capacitor will normally give a 000 readout. However, there are some capacitors, generally below 1000 pF, that are not shorted, but will still give a 000 readout on capacitor VALUE. If the leakage of these capacitors is measured, it will be discovered a low value leakage current is present. This small value of leakage current will upset the capacity measuring circuit of the "Z METER" and cause the 000 readout.

LEAKAGE IN CERAMIC, PAPER, FILM, AND MICA CAPACITORS

Ceramic, paper, film, and mica type capacitors should not show any leakage at all. The maximum allowable leakage is below the sensitivity of the measuring circuit. If any of these type capacitors exhibit leakage, they are defective.

CHECKING FOR LEAKAGE BETWEEN SECTIONS OF A MULTI-SECTION LYTIC

Multiple section lytics are common in many power supplies. Leakage sometimes develops between two or more sections of a multiple section type. This leakage may be due to an internal short circuit, or a build-up of dirt between the terminals on the outside of the capacitor. This type of leakage is particularly difficult to troubleshoot because the signal from one section of the capacitor is coupled to the other section which results in multiple symptoms in the operation of the device in which the capacitor is used.

An ohmmeter will often fail to show this leakage because it only occurs at or near the capacitor's operating voltage.

The "Z METER" will quickly locate this type of leakage while performing the standard leakage test. The sections that *are not being tested* for leakage are simply shorted out while the leakage of the first section is being monitored with the LC53 current meter. An increase in leakage indicates internal leakage between sections and a bad capacitor.

WARNING

The following procedure should only be performed by a qualified person who understands the potential hazard of up to 600 Volts being applied to the test leads while making the leakage test. Do not touch the Red test lead clip or the capacitor terminal it is connected to during the test or while the LEAKAGE button is depressed.

To test for leakage between sections of multi-section capacitor:

1. Connect one section of the capacitor to the test leads observing polarity.
2. Set the APPLIED voltage switch to the proper voltage for the section being tested. Be sure to use the correct voltage as many multi-section capacitors have different voltages for each section.
3. Depress the LEAKAGE button and observe the leakage current reading on the display.
4. Using a short jumper, connect one end to the common terminal of the capacitor and then while depressing the LEAKAGE button, connect the other end of the jumper to one of the other terminals of the capacitor not connected to the test leads. A good lytic will show no change in the leakage reading. A capacitor with leakage between sections will show an

increase in leakage when the short is applied to the untested terminal.

NOTE: Be sure to test all the terminals of the multi-section lytic against each other for leakage between sections.

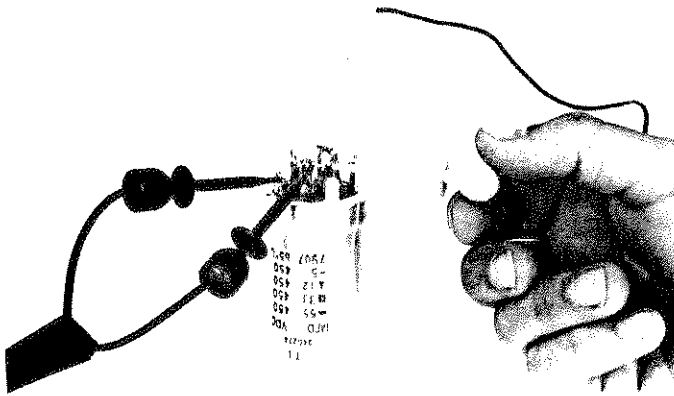

Fig. 12 — Test the leakage of one section and then short one of the other sections to ground. An increase in leakage current shows leakage between that section and the one under test.

LARGE FLUCTUATIONS IN LYTIC LEAKAGE READINGS

Leakage readings on lytics will normally start at some high value and then decrease as the capacitor charges up. When the capacitor is fully charged, there will be a small variation in the leakage reading indicating that the capacitor is trying to filter out the small variations in the line voltage. When the variations become rather large and change in large jumps, suspect an intermittent lytic. Lytics that exhibit this symptom will give trouble in the circuit and should be rejected.

LEAKAGE MEASUREMENTS OF NON-POLARIZED LYTICS

Leakage measurements on non-polarized lytics must be made in both directions. Simply make the leakage test, note the leakage current, and then reverse the leads and make the leakage test again. If both ends of the non-polarized lytic are insulated from the case, the maximum allowable leakage is the same as listed in the leakage chart. If one end is connected to the case, the allowable leakage is doubled.

LYTICS SITTING IN STOCK

Lytics that have been sitting on the shelf may show high leakage when checked. These lytics should be reformed according to the information in this manual under "Reforming Lytics with the 'Z METER'" or "Reforming Lytics with a Power Supply". Generally, a lytic that has been sitting and is checked for value and then leakage may indicate a larger capacity value when the value is rechecked. For example, the lytic may measure 1000 μF when tested before performing the leakage check. When the value is checked after the leakage test, the value may now be as high as 1100 μF . This indicates that the lytic was partially reformed when the leakage was tested. This type of lytic can

often be reformed to its original capacity with the "Z METER" or power supply or when placed in the circuit and allowed to run for a period of time.

LOW VALUE LYTICS USED IN HIGH FREQUENCY CIRCUITS

Low value lytics (1 μF to 1000 μF) used in high frequency filtering applications such as switching power supplies and AGC circuits in television can develop an above normal internal series resistance. In these applications, the series resistance will interfere with the filtering action of the capacitor and improper circuit action will result. In these rare occasions, the capacitor could be put to use in a conventional 60 Hertz power supply and function normally. Because these capacitors will function normally at 60 Hertz, they may not show up as bad on the "Z METER". In fact, the leakage of the high internal series resistance capacitor may even be lower than a good capacitor. If this is the case, connect a scope using the Lo Capacity probe across the capacitor and observe the ripple waveform when checking leakage. If the waveform has tips, as shown in Figure 13B, the capacitor has a series internal resistance that will interfere with circuit operation and should be replaced. If no tips are observed, as shown in Figure 13A, then the capacitor has very low or normal internal series resistance.

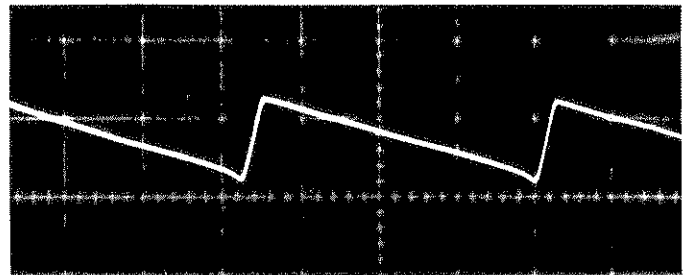

Good 2.2 μF leakage ripple .5V/Div.

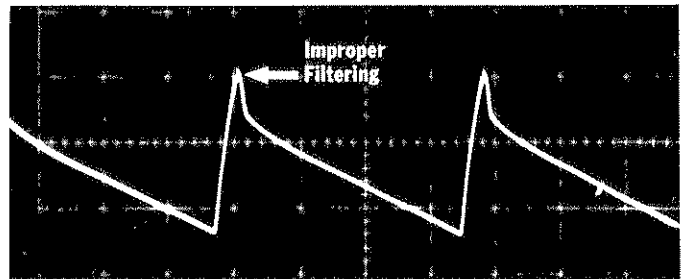

Defective 2 μF leakage ripple .5V/Div.

Fig. 13 — The scope waveform shown in A is a good capacitor with no internal series resistance. B shows a defective capacitor with internal series resistance as detected by the spikes at the top of the waveform.

INTERMITTENT CAPACITORS

Occasionally, a capacitor can become intermittent. A poor weld of the lead to the foil or other mechanical malfunction can cause the capacitor to operate in a random fashion. The leads of the suspected capacitor should be moved around or pulled on when making the Value test. A change in capacity indicates an intermittent problem.

An intermittent caused by a bad weld can sometimes show up as flashing 888 on the meter. This is due to the capacity changing at the time the VALUE button is depressed and the meter cannot lock in on a range.

INTERNAL CONSTRUCTION OF ALUMINUM ELECTROLYTIC

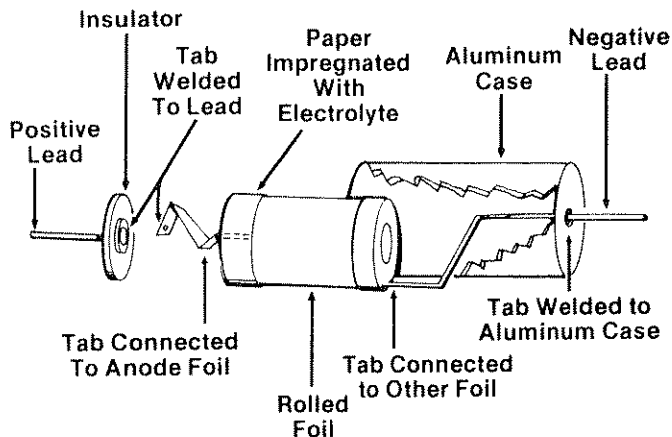

Fig. 14 — A lytic can become intermittent if the weld is not proper on either tab or becomes corroded after a long period of use.

TIME REQUIRED TO OBTAIN A VALUE READING ON A CAPACITOR

Capacitors of 1000 μF and below will read almost instantaneously. More time is required for capacitors above this value. The actual time depends upon the RC time constant of the capacitor. For example, a 50,000 μF will read in only 5 seconds and a 100,000 μF takes only 10 seconds. The meter will read 000 until the counting circuit has reached the proper level and then the capacity reading will appear on the display.

On very large capacitors, generally over 100,000 μF , the first reading may differ from later readings by as much as 10 percent. This is normal and caused by the dielectric absorption found in most types of capacitors. This slight change in readings should cause no problem because the tolerances of these capacitors are generally -20%, +80% which means that the first reading will be close enough to locate capacitors that have changed value outside the tolerance limits. If you require a very precise reading, simply leave the Capacitor VALUE button depressed until the "Z METER" has gone through at least 2 complete reading cycles.

CHECKING CERAMIC CAPACITORS FOR TEMPERATURE SENSITIVITY

Ceramic capacitors (often called disc capacitors because of their physical appearance) come in a wide variety of capacity values and temperature tolerances. By connecting the capacitor to the "Z METER" and checking the capacity and then applying heat from a

soldering iron or heat gun, the temperature variation can be seen. If the capacitor is marked COG or NPO, for example, the capacity should not change or change only slightly. If the capacitor is marked with an N, such as N1500, then the capacity will decrease as long as the heat is applied until the lower limit is reached. Capacitors marked with the letter P (not in common usage) will increase capacity with the application of heat.

CHECKING FILM TYPE CAPACITORS FOR TEMPERATURE SENSITIVITY

Film type capacitors can become temperature sensitive and cause problems in the circuit. By connecting the suspect capacitor to the "Z METER" and testing the capacity while applying heat from a soldering iron or heat gun or spraying with a "freeze spray", the change in capacity can be seen. Most film type capacitors should change very little in capacity. If a drastic change is seen, the capacitor has become temperature sensitive and should be replaced. A word of caution here — do not touch the soldering iron to the capacitor. The heat can damage the sensitive plastic film used as a dielectric and make the capacitor useless.

TESTING CAPACITY OF SILICON DIODES AND TRANSISTORS

The "Z METER" can measure the capacity of silicon diodes and transistors. The reverse leakage paths around the transistor and diode can also be measured within the limits of the leakage power supply of the "Z METER". The connections to measure capacity and leakage are the same and the proper lead connections are shown in figure 15. If the readout shows 000 when testing for capacity or flashing 888 when testing leakage, the leads are reversed. No precautions are necessary when testing capacity, but the following guidelines should be observed when testing leakage.

1. Use only the 3 Volt position of the APPLIED VOLTAGE switch when testing Ibeo.

2. Use the setting of the APPLIED VOLTAGE switch that matches the maximum applied voltage to the transistor when testing I_{cb0} or I_{ceo}. Do not exceed the ratings of the transistor. The transistor will go into a zener mode and give an incorrect leakage reading. If left in this manner, it could damage the transistor.

NOTE: The capacity of germanium transistors and diodes cannot be measured. The high leakage of these devices will upset the capacity measuring circuit of the "Z METER" and the readout will show flashing 888 when the VALUE button is depressed. The leakage of germanium devices can be measured with the leakage test the same as the silicon devices. Do not exceed the voltage rating of the device as germanium devices can be damaged quite easily.

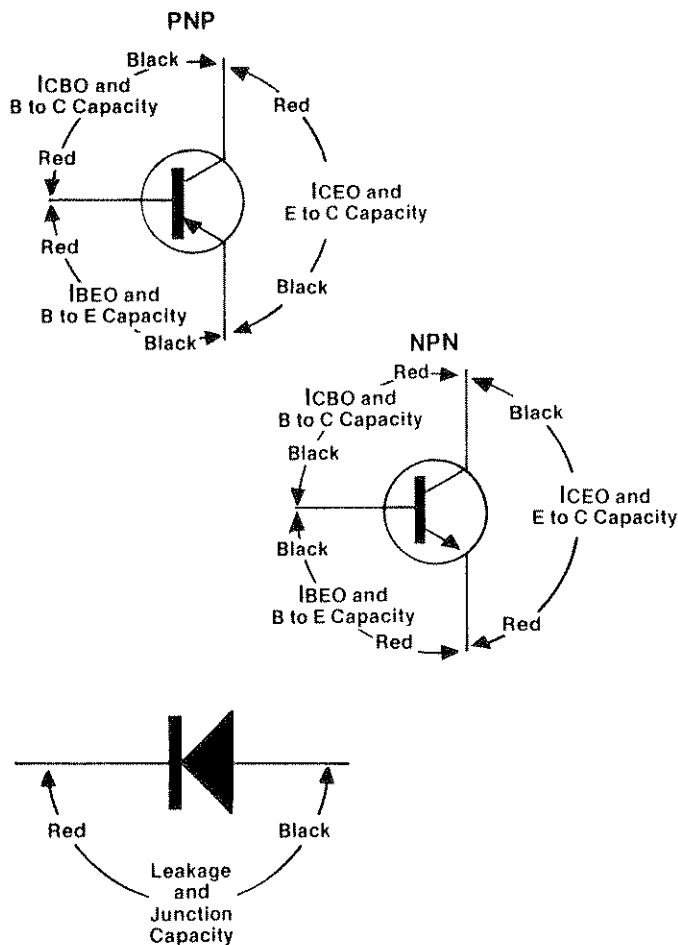

Fig. 15 — Capacity connections for measuring capacity of silicon junctions. Leakage paths are for both silicon and germanium type junctions.

TESTING HIGH VOLTAGE DIODES

High voltage diodes, such as found in TV high voltage and focus voltage sections, cannot be tested on a conventional ohmmeter because they require Voltages as high as 200 Volts before they begin to conduct. An ohmmeter, which typically supplies only 2 Volts, will simply show an open circuit no matter how the leads are connected.

The Leakage test of the LC53 provides sufficient Voltage to allow high voltage diodes to be tested for both forward conduction and reverse leakage. The diode should be tested for forward conduction first to confirm that it is not open. Then, it should be tested for reverse leakage.

WARNING

The following procedures should be performed only by a technically qualified person who understands the potential shock hazard of up to 600 Volts applied to the test leads when the LEAKAGE button is depressed.

To test a high Voltage diode:

1. Connect the red lead of the LC53 to the anode (- end) of the diode and the black lead to the cathode (+ end).

2. Begin with the APPLIED VOLTAGE switch in the 50 Volt position and depress the LEAKAGE button.

3. While holding the LEAKAGE button, increase the APPLIED VOLTAGE switch one step at a time until the digital display shows a leakage reading. Do not increase the Voltage past the point where the digital readout begins to read. Increased voltage may cause too much current to flow which may ruin the diode.

If you get all the way to 600 Volts and there is still no reading, the diode is open.

4. Release the LEAKAGE button and reverse the connection of the red and black test leads.

5. Increase the setting of the APPLIED VOLTAGE switch to the 600 Volt position.

6. Again depress the LEAKAGE button and observe the digital readout. The digital readout should stay at "000". Any leakage current indicates that the diode is leaky and should be considered defective.

TESTING SILICON CONTROLLED RECTIFIERS (SCRs) AND TRIACS

SCRs and TRIACs can be tested dynamically on the "Z METER" using the leakage function of the capacitor test. SCR's and TRIACs can be tested for turn on (latched) and turn off (unlatched) conditions and at the full rated working voltage of the device up to 600 Volts.

WARNING

The following procedures should be performed only by a technically qualified person who understands the potential shock hazard of up to 600 Volts applied to the test leads when the LEAKAGE button is depressed.

NOTE: All tests must be performed with the device out-of-circuit.

TESTING SCRS AND TRIACS FOR DC LATCHING

The following test will determine if the SCR or TRIAC will turn on and remain latched under DC conditions.

1. Connect the Red test clip lead to the anode of the SCR or to terminal 2 (MT2) of the TRIAC. Connect the Black test clip to the cathode of the SCR or to terminal 1 (MT1) of the TRIAC.

2. Set the LEAKAGE RANGE switch to the LARGE ALUMINUM ELECTROLYTICS (10K uA max) range.

3. Set the APPLIED VOLTAGE switch to the 10 Volt position and depress the LEAKAGE button. The display should show 0000, indicating no leakage.

a. If the Display shows an overrange condition of 888, the device under test is shorted.

b. If the Display shows a reading other than 0000, the device shows excessive leakage and should be replaced.

4. Connect an insulated jumper lead from the gate of the device being tested to the lead connected to the Red test clip (anode or MT2).

5. Depress the LEAKAGE button. The display should show an overrange condition of flashing 888 if the device is good or has latched ON. Remove the short with the LEAKAGE button still depressed. The display should still show flashing 888 indicating that the device is latched and will remain latched until the voltage is removed by releasing the LEAKAGE button. If the device does not show the flashing 888 when the short is removed, the gate is defective.

6. Release the LEAKAGE button. Depress the LEAKAGE button again without the short applied. The display should show 0000. This indicates that the device turned off when the DC voltage was removed. Any other reading indicates a defective device.

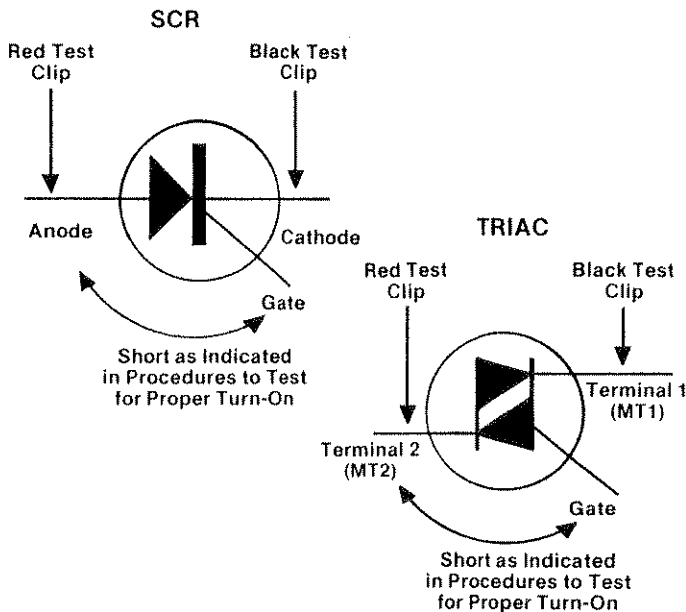

Fig. 16 — Load connections for testing SCRs and TRIACs.

TESTING SCRS AND TRIACS FOR AC LATCH AND UNLATCH CONDITIONS

The following test will determine if the SCR or TRIAC will turn on and off with the AC voltage as it should. The pulsating DC voltages of the LC53 were designed to make this test so that the SCR and TRIAC would be operated under normal operating conditions, just like they would be in-circuit.

NOTE: All tests must be performed with the device out-of-circuit.

1. Set the APPLIED VOLTAGE switch to the working voltage of the device to be tested.

NOTE: If the working voltage is unknown, use the 15 Volt setting of the APPLIED VOLTAGE switch.

2. Connect the Red test clip to the anode of the SCR or to terminal 2 (MT2) of the TRIAC. Connect the Black test clip to the cathode of the SCR or to terminal 1 (MT1) of the TRIAC.

3. Depress the LEAKAGE button. The display should show 0000, indicating no leakage at the rated voltage. Any leakage reading here indicates that the device is defective and should be replaced.

4. While depressing the LEAKAGE button, short the gate of the device being tested to the lead connected to the Red test clip with an insulated jumper. Observe the Warning notice above. The display should show an overrange condition of flashing 888, indicating the device has turned ON. Remove the short and the overrange should drop to 0000 in just a few seconds, indicating that the device has turned OFF.

NOTE: If the SCR or TRIAC does not show flashing 888 when the gate is shorted to the anode or terminal 2 (MT2) or does not drop to 0000 in just a few seconds when the short is removed from the gate, the device is defective and should be replaced.

DETERMINING THE LENGTH OF RF COAXIAL CABLE

The actual length of a piece of coaxial cable or the point at where a break exists can be determined very accurately with the "Z METER". Each type of coax has a nominal amount of capacity per foot of length. Simply measure the capacity of the cable unterminated and divide by the capacity per foot to find the length or the point of the break in the cable. The "Z METER" will measure the break point capacity regardless if the break is in the shield or the center conductor. The break point can be found by the simple steps below. If at all possible, measure from both ends of the cable to pinpoint the break much closer.

1. Measure the capacity of the cable (must be open and unterminated) with the "Z METER". Connect the red test clip to the center conductor and the black test clip to the shield braid.

2. Divide the reading from the "Z METER" by the cable capacity per foot. This gives the distance or length of the cable from the measuring point in feet.

NOTE: The accuracy of the measurement depends upon the cable capacity tolerance since the value listed is a nominal figure and can vary slightly with manufacturer. The normal tolerance is within 2%. If the cable has several locations where there is excessive crimping or clamping, the capacity will change at those points and will affect the overall reading. If the cable is shorted or terminated, the "Z METER" will not be able to read the capacity. The following section indicates how to locate a short.

**RF COAXIAL CABLE
50 - 55 Ohm**

RG/U Cable Type	Nominal Impedance	Nominal Cap in pF/FT	Nominal Inductance
5B/U	50	29.5	
8U	52	29.5	
8U Foam	50	26	
8A/U	52	29.5	
10A/U	52	29.5	
18A/U	52	29.5	
58/U	53.5	28.5	
58/U Foam	50	26	
58A/U	50	30.8	
58C/U	50	29.5	
58C/U Foam	50	26	
74A/U	52	29.5	
174/U	50	30-30.8	
177/U	50	30	
212/U	50	29.5	
213/U	50	30.5	
214/U	50	30.5	
215/U	50	30.5	
219/U	50	30	
225/U	50	30	
224/U	50	30	

Chart 4 — Capacity of typical RG Coaxial Cable.

**RF COAXIAL CABLE
70 - 75 Ohm**

RG/U Cable Type	Nominal Impedance	Nominal Cap in pF	Nominal Inductance uH/FT
6A/U	75	20	
6A/U Foam	75	20	
11U	75	20.5	
11U Foam	75	17.3	
11A/U	75	20.5	
12A/U	75	20.5	
13A/U	74	20.5	
34B/U	75	20	
35B/U	75	20.5	
59/U	73	21	
59/U Foam	75	17.3	
59/U Double Shield	75	17.3	
59/BU	75	20.5	
164/U	75	20.5	
216/U	75	20.5	
82 Channel	73	17.5	

**RF COAXIAL CABLE
90 - 125 Ohm**

RG/U Cable Type	Nominal Impedance	Nominal Cap in pF	Nominal Inductance uH/FT
62/U	93	13.5	
62A/U	93	13.5	
63B/U	125	10	
71B/U	93	13.5	
79B/U	125	10	

HOW TO FIND A SHORT IN A COAXIAL CABLE

A break in a coaxial cable may be located with the Capacity test as indicated in the previous section. A shorted cable, however, will not read on the Capacity test. The Inductance test should be used to locate a short.

The amount of inductance per foot is generally not published by the cable manufacturer. This value may be determined by using the "Z METER" to measure a known length of the cable (as explained in the next section) before performing the Inductance test. Space has been left in the charts above for the inductance per foot to be added as you encounter different cables.

To find the approximate distance to a short:

1. Measure the inductance of the shorted cable. The red test clip should be connected to the center conductor and the black test clip to the shield braid.
2. Divide the reading obtained by the inductance per foot that you have measured to find the distance in feet from the measuring point to the short.

HOW TO FIND THE INDUCTANCE PER FOOT OF COAXIAL CABLE

A known length of cable should be measured with the "Z METER" to find the value of inductance per foot. A length of at least 20 to 25 feet is recommended to obtain a more accurate reading. A length of 10 feet may be too short to give a good inductance value.

1. Connect the known length of cable to the "Z METER", the center conductor to the red test clip, and the shield braid to the black test clip. Short the center conductor to the shield at the opposite end.
2. Measure the inductance. Divide the reading obtained by the length of the cable. Record this figure in the chart for future reference.

NOTE: The inductance may vary slightly with the same type of cable due to the variations in manufacture. The measuring tolerance to the point of a short should be within 2% in most cases. For finding a short, it is recommended that the cable be measured from both ends to pinpoint the short closer.

INDUCTORS

The "Z METER" measures the actual inductance of coils using a patent-pending circuit. Simply connect the test leads to the coil and depress the VALUE button and read the inductance in uH or mH on the display.

WARNING

Do not connect the test leads to a circuit having power applied. Be sure the power is "OFF" by disconnecting the AC line cord to the equipment under test.

CHECKING INDUCTORS FOR INDUCTANCE VALUE

1. Connect the test leads to the coil or transformer to be tested.
2. Depress the Inductors VALUE button.
3. Read the value of inductance of the coil or transformer on the digital display. The LED will light in front of uH if the value is in microhenrys or in front of the mH if the value is in millihenrys.

NOTE: A reading of flashing 888 with a steady zero indicates an open circuit. Recheck your lead connections to make sure you are connected to the proper terminals.

The above procedure provides accurate readings on inductors over 1000 uH. Small value inductors between 2 uH and 1000 uH may be off slightly due to the inductance of the test leads. This inductance may be balanced out for high accuracy readings with the LEAD ZERO control.

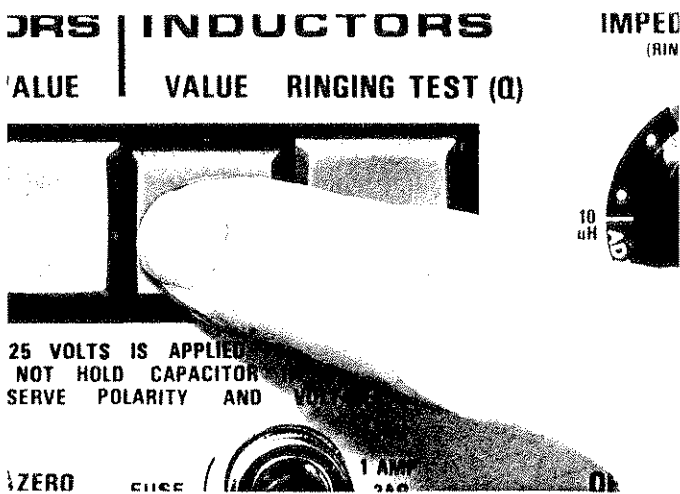

Fig. 17 — Simply connect the inductor to be tested to the test leads, push the VALUE button and read the inductance value on the display. There is no range switches on the LC53.

BALANCING OUT LEAD INDUCTANCE

1. Place the test leads on the work area in such a way that they will not be moved when connecting a coil. Be sure the leads are not on a metal surface, near AC power or an AC operated device. Short the test lead clips together.

2. With the test leads shorted, depress the Inductance VALUE button and adjust the LEAD ZERO control until the display reads 00.0 with the negative sign appearing occasionally.

NOTE: Adjust the LEAD ZERO control slowly as the LC53 requires about 2 seconds between readings when the test leads are shorted.

3. Carefully connect the coil to the test leads being careful not to disturb the position of the leads if possible. Depress the Inductors VALUE button and read the inductance value on the display.

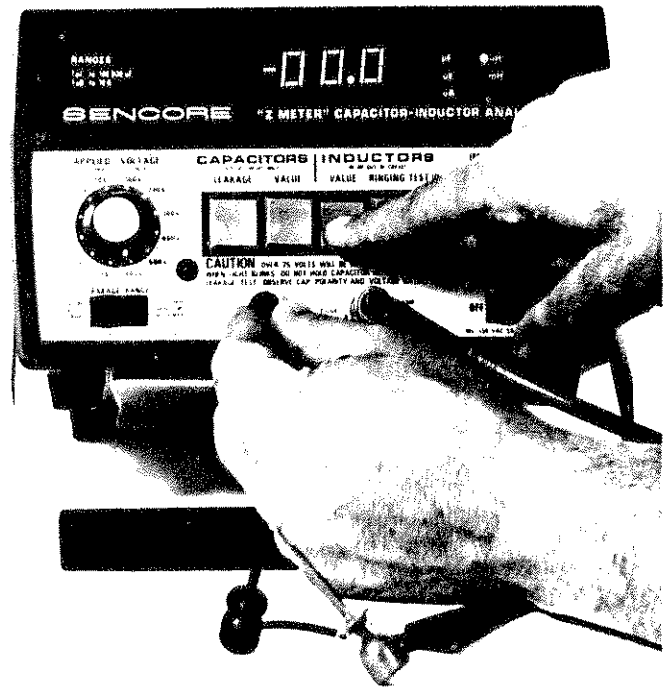

Fig. 18 — The inductance of the test leads can be balanced out for accurate readings of small value inductors.

CHECKING COILS BELOW 2 MICROHENRYS

The "Z METER" may show a reading of 00.0 for coils under 2 uH in value. This is due to the "zero window" that is necessary in the autoranging circuit. Values of coils below 2 uH can be read by offsetting the meter with the LEAD ZERO control.

To Read Value of Coils Below 2 uH:

1. Place the test leads on the work area in such a way that they will not be moved when the coil is connected.

2. Short the test leads together. Depress the Inductors VALUE button and adjust the LEAD ZERO control until the display shows a reading of 2.0 uH.

NOTE: If the LEAD ZERO control is turned in the wrong direction, a negative sign will appear in front of the reading. Adjust the LEAD ZERO control for a positive reading.

3. Unshort the test leads and carefully connect the coil to the test leads without disturbing their position.

4. Depress the Inductor VALUE button and obtain a reading on the digital display. Subtract the 2 uH set up in step 2 from the reading on the display for the actual inductance value of the coil. For example, if the display shows a reading of 2.8 uH, the actual value is 2.8 minus the 2.0 or 0.8 uH.

OPEN WINDING IN A COIL

Open windings in coils are easily spotted with the "Z METER". Just hook up the "Z METER" to check the inductance value. If the display shows flashing 888 with a stationary 0, then the coil is open. Check the lead connections to the coil to be sure. If the coil is a small wire type, be sure to check the fine wires that go to the solder lugs on the coil form. The fine wire can be broken easily from tension or extreme heat and cold variations.

On large transformers that have several taps or windings in series, simply check from top to bottom for an open. The actual open can be isolated by moving one lead down the series of taps until the "Z METER" gives an inductance reading. The tap above this point has the open winding.

NOTE: On multitap transformers such as flyback transformers, check the terminals the test leads are connected to. If the "Z METER" shows an open, you may be connected to the wrong terminals.

CHECKING INDUCTANCE IN-CIRCUIT

WARNING

Do not connect the test leads to a circuit having power applied. Be sure the power is "OFF" by disconnecting the AC line cord to the set under test.

The "Z METER" can check the value of inductors in-circuit for the actual inductance value. Simply connect the test leads to the coil and depress the Inductors VALUE button and read the inductance value on the display. Circuit impedance will have some effect on the readings. The values of resistors that can be paralleled with the inductor and decrease the inductance value by only 10% are as follows:

2 to 90 uH — 100 Ohms
90 uH to 9 mH — 300 Ohms
9 mH to 90 mH — 1.5K Ohms
90 mH to 900 mH — 5K Ohms
900 mH to 10 H — 10K Ohms

If the value of resistor is larger than that listed, the measuring error will be less than 10%.

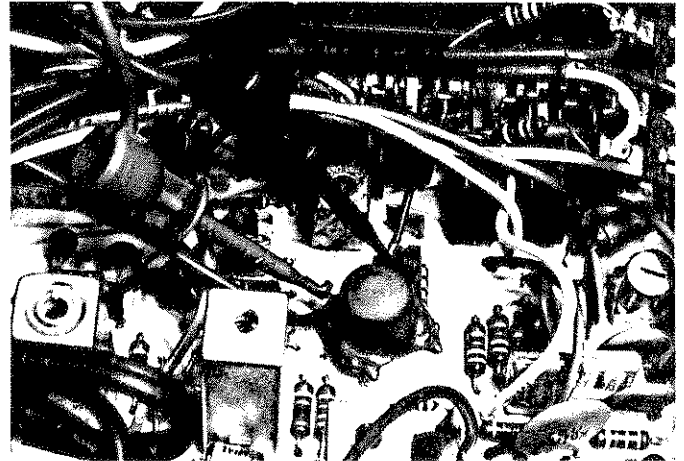

Fig. 19 — Inductance values can be checked in-circuit with the LC53 inductance test.

Coils in a television or two-way radio can be checked quickly and easily for value. If a coil is open and shunted by a resistor (something that might be missed with an ohmmeter), the "Z METER" will not read the correct value, but a much higher value. For example, the coils in a CB transceiver will normally run around .2 or .5 uH. If the coil is open, the "Z METER" will read flashing 888 with the stationary 0 if there is no resistor shunting the coil. If a 1K Ohm resistor is shunting the coil, the "Z METER" will read about 2.8 mH.

TESTING INDUCTORS ON PRINTED CIRCUIT BOARDS

On most PC boards, the leads to any components are very short which may make connections difficult. The E-Z Hook® clips used with the "Z METER" will connect to many of the coils that you wish to test. When there is no lead to connect to, you can use the Sencore 39G85 Touch Test Probe (optional accessory) to make contact with the leads of the coils. Connect the 39G85 to the "Z METER" test leads as follows:

1. Connect the Red clip of the test leads to the R point on the top of the 39G85. Connect the Black clip to the Y point on the top of the 39G85.

NOTE: These are the two longest probe points and will make it easier to use when checking coils.

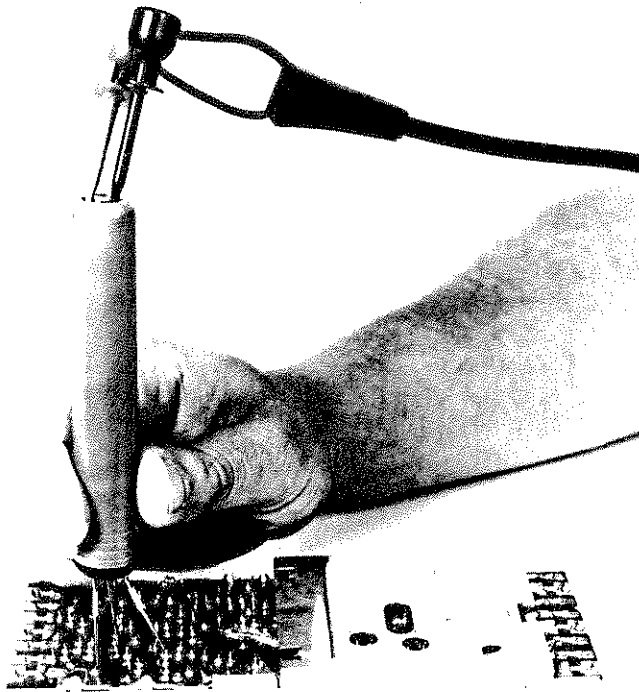

Fig. 20 — The 39G85 (optional accessory) can be used with the "Z METER" to check the inductance and ringing of coils that are mounted flat to the PC board.

2. Make contact to the point on the PC board for one side of the coil to be tested with the Red probe point and apply slight pressure to hold it in place. Then make contact to the other coil point with the Yellow probe point and apply pressure to hold the 39G85 in place.

3. Depress the Inductors VALUE button and read the inductance on the digital display.

MUTUAL INDUCTANCE

If two or more coils are wound on the same form and connected either internally or externally, the total inductance measured from end to end with the "Z METER" will not be equal to the measured inductance of the individual windings. The measured value may be higher or lower than the measured value of the individual windings due to the mutual inductance of the coils. The measured value of the total will be affected by the spacing between the windings, the type of windings used, and the core material used to wind the coils on. The actual value cannot be pre-determined by simply looking at the coils. The "Z METER" will measure the actual inductance of the combination of coils just as the circuit would see it.

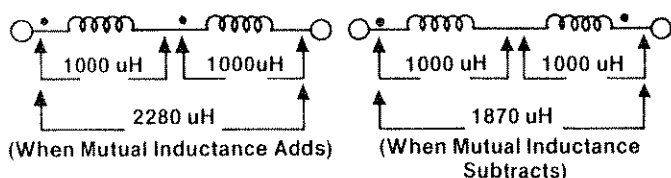

Fig. 21 — The inductance readings of the "Z METER" will show the actual inductance of two coils with mutual inductance. Mutual inductance can either add or subtract for the individual readings of the windings.

VALUE READINGS ON HIGH RESISTANCE COILS

Coils with high internal resistance will cause most types of inductor testers (including bridges) to read the actual inductance value slightly off-value. The special (patent-pending) inductance test provided by the "Z METER" compensates for the series resistance of the majority of all coils tested. There are, however, a few coils whose DC resistance is larger than the range of resistance compensation that can be built into the "Z METER" without affecting accuracy on standard low resistance coils.

The following table lists the DC resistance necessary to affect the accuracy of the "Z METER" reading. Notice that each of the six auto-ranged inductance scales has a different correction factor applied by the "Z METER" to compensate for larger resistance values on higher inductance coils. This assures the highest possible accuracy for the majority of coils tested.

COIL RESISTANCE EFFECT ON INDUCTANCE VALUE READING

Coil Inductance	ACCURACY FOR COIL RESISTANCE	
	2% or Better	2 - 5%
1 uH - 90 uH	4 Ohms or less	4 - 10 Ohms
100 uH - 900 uH	40 Ohms or less	40 - 100 Ohms
1 mH - 9 mH	40 Ohms or less	40 - 100 Ohms
10 mH - 90 mH	170 Ohms or less	170 - 400 Ohm
100 mH - 900 mH	500 Ohms or less	500 - 2000 Ohms
1000 mH - 9000 mH	1500 Ohms or less	1500 - 6000 Ohms

Chart 5 — Accuracy of LC53 versus resistance of coil.

INDUCTOR CODING

Inductors can be found with several different color codes of which the two most common are shown here. The strip code on the postage stamp coils may also be a series of dots. The two codes shown here are by no means all the codes that may be encountered. When a strange code is found, consult the manufacturer's service literature for the values.

Charts on following page.

TUBULAR ENCAPSULATED RF CHOKES

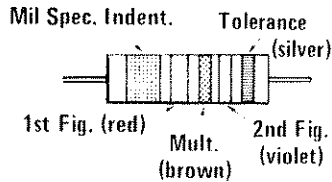

Example shown is for 270 uH 10% choke

Color	Figure	Multiplier	Tolerance
Black	0	1	
Brown	1	10	
Red	2	100	
Orange	3	1,000	
Yellow	4		
Green	5		
Blue	6		
Violet	7		
Gray	8		
White	9		
None			20%
Silver			10%
Gold			5%

Multiplier is the factor by which the two color figures are multiplied to obtain the inductance value of the choke coil in uH.

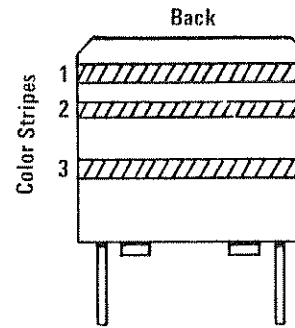

"POSTAGE STAMP" FIXED INDUCTORS

Color	1st Digit 1st Strip	2nd Digit 2nd Strip	Multiplier 3rd Strip
Black or (Blank)	0	0	1
Brown	1	1	10
Red	2	2	100
Orange	3	3	1,000
Yellow	4	4	10,000
Green	5	5	100,000
Blue	6	6	
Violet	7	7	
Gray	8	8	
White	9	9	
Gold			X.1
Silver			X.01

Values will be in uH.

Chart 6 — Typical Inductor color codes.

CHECKING INDUCTORS FOR GOOD OR BAD WITH THE RINGING TEST

The patented Ringing test allows you to determine if a coil (without an iron core) is good or bad with an accurate but easy to perform test of the quality or "Q" factor. A special impedance matching circuit establishes a reference for all coils larger than 10 uH. A good coil should show a reading of 10 or more on the digital display. A bad coil will show less than 10 ringing cycles.

The Ringing test measures the "Q" factor by applying a reference pulse to the coil and then digitally counting the number of ringing cycles produced until the signal is damped to a preset level. A shorted turn in a coil will lower its Q and cause the ringing to dampen faster than in a good coil. An open coil will show no ringing.

The patented Sencore Ringing test is based on the Q of the coil, but the readings on the "Z METER" will not agree with those obtained with a bridge or a Q meter. The reason is simply that the Q test has been simplified to make the number 10 a reference point.

IMPEDANCE MATCH

(RINGING TEST ONLY)



Fig. 22 — The IMPEDANCE MATCH switch is divided into two sections, the four positions in red for TV yokes and flybacks, or all six positions for other type coils and transformers.

The Ringing Test IMPEDANCE MATCH switch is divided into two sections. The four positions marked in red are the only positions that should be used for testing television yokes and flybacks. The sensitivity of the Ringing test circuits in these positions is matched

to the impedance and frequency specifications of these special coils.

All six positions should be used for testing other types of coils. The two positions marked in blue have additional sensitivity to allow small value coils to be tested accurately. The four red positions will match properly to large value coils.

SPECIAL NOTES

1. The Ringing test should be not be used on coils and transformers having laminated iron cores such as power transformers, audio output transformers, and filter chokes. The iron core in these types of transformers and coils absorbs the ringing energy of the coil and results in low readings that are unreliable.

2. Good coils below 10 uH in value may not ring 10 cycles. The low inductance of these coils generally allows only about 2 to 4 cycles. A comparison test should be made on a known good coil to see if the Q factor results are correct.

3. Some coils above 10 uH may not show 10 or more rings due to the nature of the construction or core material used in the coil. These may show 8 or 9 rings and still be good. The quality of these coils may be confirmed by adding a "shorted turn" and rechecking the ringing of the coil. If the coil is bad, the number of rings will not change or change very little, indicating the coil already has a shorted turn. If the number of rings drops off drastically, then the coil is good. A good "shorted turn" can be made from a piece of solder wrapped around the coil tightly and twisted together at the ends. Small diameter wire or stranded wire does not give the same affect and could give misleading results. Be sure to use solder or a heavy gauge solid wire for the "shorted turn".

To Test the Quality of a Coil with the Ringing Test:

1. Connect the test leads to the inductor to be tested.

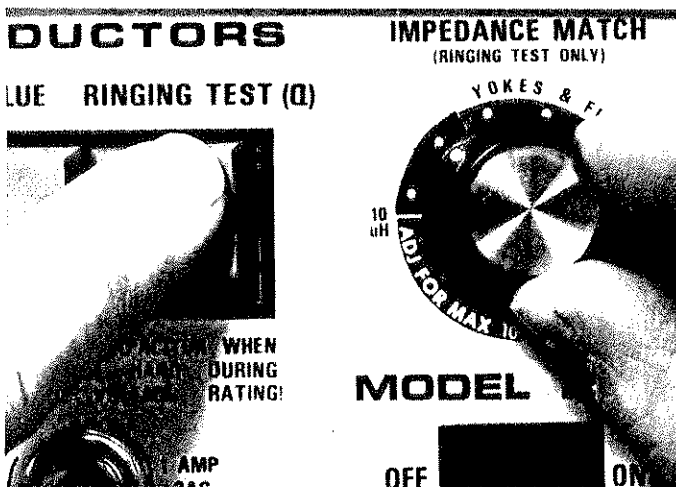

Fig. 23 — An inductor can be checked for quality by simply connecting the inductor to the test leads, depressing the RINGING TEST button and rotating the IMPEDANCE MATCH switch and watching the display for the number of ringing cycles.

2. Depress the RINGING TEST button. Hold the button down and rotate the IMPEDANCE MATCH switch through all 6 positions for regular inductors or through the last 4 positions for TV yokes and flybacks.

3. If a reading of 10 or more appears on the display in one or more positions of the IMPEDANCE MATCH switch, the inductor is good. If a reading of less than 10 is displayed on all positions of the switch, the inductor is defective. Refer to the Inductor Testing Applications and the section on testing yokes and flybacks for further information.

NOTE: The "Z METER" may show a continuously changing reading when using the two most sensitive positions of the IMPEDANCE MATCH switch in the presence of high AC power radiation. This can occur if: 1.) The coil is open and near a source of high level AC power radiation, 2.) The leads are not connected properly or connected to the wrong terminal or not making proper contact and picking up AC radiation, 3.) Touching the Red test clip and injecting AC into the "Z METER", and 4.) Depressing the Ringing Test button with the leads not connected to anything and near a source of high level AC power radiation. If the continuously changing reading occurs, move the coil being tested to a location away from the source of AC radiation and check the connections to the coil. If you suspect that the coil may be open or the leads not connected properly, merely recheck the inductance value. If the readout shows a flashing 888 with a stationary 0, the coil is open or the leads are not connected properly.

INDUCTOR TESTING APPLICATIONS TIPS

The patented Ringing test on the Sencore "Z METER" has been designed to test coils and transformers for an indication of good or bad. The ringing test can be made in-circuit as well as out of circuit for fast troubleshooting. The following application tips cover special situations you may encounter when testing in-circuit. Review these notes carefully before making any in-circuit tests. The applications tips are divided into two sections, one on general coils and transformers and the other devoted to TV flyback transformers and yokes.

QUALITY TESTING ON GENERAL COILS AND TRANSFORMERS

PEAKING COILS

Coils wound on resistors (peaking coils) may not give a good indication on the Ringing test due to the damping action of the resistor. The lower the value of the resistor, the lower the Ringing test will read. For example, a 1000 uH coil wound on a 10K Ohm resistor will just make 10 rings. The action of the resistor is to dampen out the oscillations or ringing in the circuit and it will do the same on the Ringing test.

COILS IN METAL SHIELDS

Coils and transformers that are shielded with a metal shield may not show good on the Ringing test. The metal shield may absorb the ringing energy depending on how close the shield is to the coil. You should consider a shielded coil good if it shows 10 or more rings. If the coil shows less than 10 rings in all positions of the IMPEDANCE MATCH switch, you should either remove the shield and repeat the test or make a comparison test on a known good shielded coil. Be sure the coil is identical to the one in the circuit being tested for accurate results.

FERRITE CORE TRANSFORMERS AND COILS

Coils and transformers that use ferrite cores will normally show good ringing if the coil is good. The value of the coil or transformer must be above 10 uH to show a ringing test of 10 or more just like regular coils.

TESTING TV FLYBACK TRANSFORMERS AND YOKES WITH THE RINGING TEST

The patented Sencore Ringing test allows the testing of yokes and flybacks in- or out-of-circuit. Simply connect the yoke or flyback to the test leads, depress the RINGING TEST pushbutton and rotate the IMPEDANCE MATCH switch through the four yoke and flyback positions (marked in red). A display of 10 or more on any one of the four positions indicates a good yoke or flyback. If the reading is less than 10 in all four positions of the IMPEDANCE MATCH switch, the Ringing test will help locate the cause of the low reading, a shorted turn or a circuit loading the yoke or flyback down.

WARNING

Do not connect the "Z METER" test leads to the yoke or flyback in the set until ALL power to the set has been removed. For your safety, disconnect the AC line cord to the receiver from the AC outlet.

IN-CIRCUIT QUICK TEST

1. Connect the red clip to:
 - a. Plate cap of a tube set.
 - b. Collector or input to the tripler of a solid-state set.
2. Connect the black clip to:
 - a. The cathode of the damper tube or anode of the boosted boost rectifier or similar locations that is DC connected to the plate cap through the windings of the flyback for a tube set.
 - b. The B+ input to the horizontal output transistor or to ground. If the set uses an isolated ground, connect to the B+ input point only.

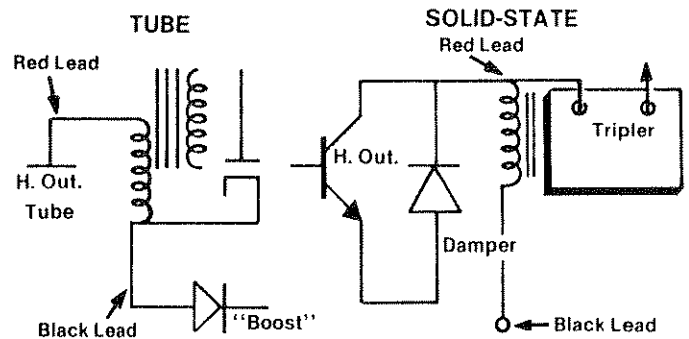

Fig. 24 — The "Z METER" can be connected for a quick-in-circuit ringing test in tube or solid-state.

3. If the set has a high voltage rectifier tube, remove it as the filaments may act as a short and cause the "Z METER" to give a false reading of less than 10.

4. Depress the RINGING TEST pushbutton and hold it down while rotating the IMPEDANCE MATCH switch through the four yoke and flyback positions marked in red. If the meter reads 10 or more in one or more positions of the switch, the flyback is good. If the display shows less than 10 in all four positions of the switch, a short or load on the flyback is indicated.

NOTE: The first four steps will identify a good flyback. If a reading of less than 10 is indicated, the flyback may still be good but a circuit could be loading it. Use the remaining steps to locate the defect.

5. If the test results in the previous steps result in a readout of less than 10 in all four positions, unplug or unsolder the yoke leads from the horizontal windings and repeat the test.

6. If the readout is still less than 10 on a solid state set, disconnect one end of the damper diode and repeat the Ringing test.

7. If the readout is still less than 10, unplug the convergence coils and repeat the Ringing test.

8. If the readout is still less than 10, start disconnecting the other coils from the flyback (such as the AGC winding) one at a time. Perform the Ringing test each time a load is disconnected until you either find: 1.) the flyback begins to read good, or 2.) all the leads have been removed from the flyback and it still tests bad. If all the leads have been removed and the display still shows less than 10 in all four positions, the flyback is defective. If, on the other hand, the flyback begins to read good after a load has been removed, the flyback itself is good. The last load to be disconnected should be tested as there is a short which is loading the ringing circuit. The flyback may be tested out of circuit using the same procedure.

NOTE: The flyback will test "bad" if: 1.) the coil under test is open, 2.) the coil under test has one or more shorted turns, or 3.) any other coil in either the primary or the secondary of the transformer has one or more

shorted turns. This third point is true because a shorted turn in any coil will lower the Q of all the other coils through mutual inductance.

A coil in the secondary may occasionally open rather than short. This type of failure will only affect the coil that is open and will not affect the other coils. If the operation of the receiver indicates the possibility of an open winding, there are two ways to test each individual winding. First, you can ring each coil separately. Second and faster procedure is to leave the "Z METER" connected to the primary winding and apply a short circuit to each of the other windings in the transformer.

An externally applied short will lower the Q of all the other windings, just like an internal short. Simply note the number of ringing cycles displayed with no external short applied. Then use a small jumper to short out the secondary you wish to test. Repeat the Ringing test with the external short applied. You do not need to rotate the IMPEDANCE MATCH switch for these additional tests. Simply leave it in the position that gave the highest number of rings when the coil was tested without the external short.

If the secondary coil you are testing is open, you will not see any change in the reading when you depress the RINGING TEST pushbutton when the external short is applied. If, on the other hand, the coil is good, you will see fewer ringing cycles displayed. Repeat this test on all the secondary coils.

NOTE: If the transformer has several coils connected in series, simply connect across the ends of the series connected coils. An open in any coil will result in no change in the number of ringing cycles displayed.

SPECIAL NOTES:

A few of the newer yokes and flybacks have been designed with very low inductance for use in certain solid-state receivers. These yokes and flybacks may not ring 10 or more times but may show only 8 or 9 rings even when good. The question of good or bad can be answered quickly by adding a "shorted turn" and rechecking the number of rings. If the number of rings does not change or changes only slightly, then the yoke or transformer already has a shorted turn. If, the number of rings drops off drastically, then the yoke or flyback is good. This method can be used on any suspected yoke, flyback, or inductor.

A simple "shorted turn" is a piece of solder. Simply form it into a loop and press it close to the windings of the yoke or wrap it around the core or windings of the flyback. Do not use a fine wire or stranded wire as they do not give the same affect and could give misleading results. Be sure to use solder or a heavy gauge solid wire for the "shorted turn".

Some of the newer flybacks are being made with the High Voltage rectifier diodes built right into the flyback itself. The Diodes are included as part of the transformer winding. Because of the reverse breakdown of the diodes, the high voltage winding

cannot be checked directly with the Ringing test. The flyback must be checked from the primary windings to determine if it is good or bad.

If there is a lack of high voltage and the flyback shows good ringing, one of the diodes is open. If the high voltage is several thousand volts low and the flyback shows good ringing, one of the diodes is shorted. In both cases, the flyback must be replaced as the diodes are not replaceable.

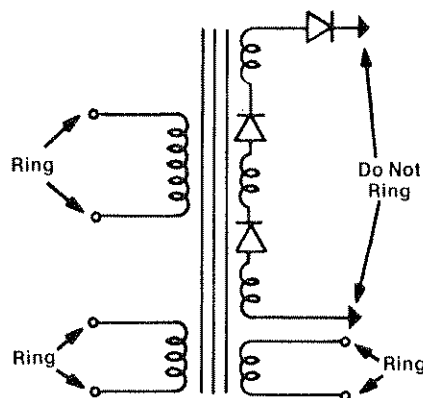

Fig. 25 — Ring only the primary and the individual windings of the transformers with built-in high voltage rectifiers. The high voltage winding cannot be rung because of the breakdown potential of the diodes.

TESTING YOKES WITH THE RINGING TEST

If the flyback checked bad and then checked good when the yoke was disconnected or the symptoms on the screen indicate a possible bad yoke, the yoke should be tested with the Ringing test to be sure.

WARNING

Do not connect the "Z METER" to the yoke or flyback in the set until ALL power to the set has been disconnected. For your safety, remove the AC line cord of the receiver from the AC outlet.

SPECIAL NOTE:

The yoke should be tested while it is still mounted on the CRT. Occasionally, there is a short caused by the pressure of the mounting of the yoke. Removing the yoke from the CRT will relieve the pressure and the short may disappear. The results if the yoke is removed before it is tested is a yoke that is bad when mounted, but tests good when off the CRT.

TESTING HORIZONTAL YOKE WINDINGS FOR GOOD OR BAD

1. Disconnect the yoke leads from the circuit. On sets with a yoke plug, simply pull the plug. If the leads are soldered to the flyback or PC board, carefully unsolder them noting where they were connected.

2. Connect the test leads from the "Z METER" to the horizontal windings of the yoke. Depress the RINGING TEST pushbutton and hold down. Rotate the IMPEDANCE MATCH switch through the four

positions for yoke and flybacks (marked in red). A display of 10 or more on any one of the four positions indicates a good yoke winding. A display of less than 10 on all four positions of the switch indicates a defective yoke.

NOTE: The horizontal windings of the yoke can check good and still have a bad yoke if the vertical windings are bad. Be sure to check both the vertical and the horizontal windings of the yoke with the Ringing test.

TESTING VERTICAL YOKE WINDINGS FOR GOOD OR BAD

1. Disconnect the yoke from the circuit. On sets with a yoke plug, simply pull the plug. If the leads are soldered to the vertical output transformer or the PC board, unsolder them noting where they were connected so that they may be reconnected or the new yoke connected to the proper points.

2. Check the yoke for damping resistors. Some yokes use a damping resistor across the vertical windings. These should be disconnected at one end as they will swamp out the ringing test and possibly give erroneous results.

3. Connect the test leads from the "Z METER" to the vertical windings of the yoke. Depress the RINGING TEST button and read the number of ringing cycles on the display. A reading of 10 or more rings in any of the four positions of the IMPEDANCE MATCH switch for yokes and flybacks (marked in red) indicates that the yoke is good. A display of less than 10 in all four positions indicates a defective yoke.

NOTE: On series connected vertical yoke windings, the windings should be tested individually. If there is an imbalance of more than 3 rings or the inductance is more than 10% different between the two windings, the yoke will give trouble in the receiver. A good yoke will give almost identical readings on both windings.

MAINTENANCE

WARNING

These servicing instructions are for use by qualified personnel only. To avoid electric shock, do not perform any servicing other than that contained in the operating instructions unless you are qualified to do so.

INTRODUCTION

This Maintenance and Service section of the manual will help you maintain your LC53 within the published specifications. The schematic, parts list, and board lay-outs are included on separate sheets.

CHECKING THE LC53 ACCURACY

The accuracy of the LC53 should be checked against lab type standards to insure that the accuracy is correct. If lab type standards are not available, use stable type capacitors that have been measured with the "Z METER" when it was new and compare them on an annual or semi-annual schedule. Do not use aluminum electrolytic capacitors as a reference. These will change with age and the capacity will not be consistent. Polypropylene or polystyrene are recommended as they will have the best temperature characteristics.

NOTE: This is recommended only as a check and not as a standard to be used for calibration.

ACCESS/DISASSEMBLY

See Warning on page 37!

Access to the interior of the LC53 for recalibration and/or service may be obtained using the following procedure.

1. Unplug the unit from the AC line.
2. Remove the four screws (two on each side) at the rear of the instrument.
3. Place the unit on end with the handle and front panel pointing upward. Pull gently on the handle while holding the back portion of the case. The case will now slip from the chassis and rear portion exposing the printed circuit boards and all the calibration controls.

There is no need to further disassemble the unit unless access to both sides of a printed circuit board is required for service. If this is the case, then proceed as follows:

4. Unplug all the connectors from both boards. There are several single terminal connectors that must also be disconnected.
5. Remove the four screws (one at each corner) of the top printed board.
6. Carefully lift the rear of the printed board assembly

and pull away from the front of the unit. The two PC boards will come out as an assembly from the unit.

7. To separate the two PC boards, remove the two screws at the rear of the assembly. Carefully lift the top PC board from the bottom board. Lift carefully so that the pins of the plug connecting the two boards are not damaged.

8. To reassemble, reverse the order of the procedure.

EQUIPMENT REQUIRED FOR CALIBRATION

The following equipment is recommended for use in calibrating the "Z METER". These are high accuracy standards and will allow the calibration of the meter to the specifications in the front of the manual. Lower accuracy standards will reduce the accuracy of the "Z METER". If capacitors and inductors of known values are available, they may be used for calibration.

If known values of capacitors and inductors or the following equipment is not available, the meter may be returned to the Sencore Service Department for check out and recalibration for a small service charge.

GenRad model ^{1490D} 1491G Standard Inductor (covers all ranges except the 100 uH range of the "Z METER").

Hewlett Packard model HP16481A 56 uH Standard Inductor.

Hewlett Packard model ^{GR1419K} 4440B Standard Capacitor Decade (covers all ranges except the 800 uF for the top range of the "Z METER").

^{NO} 800 uF film type capacitor (can be made up of 20 - 25 uF film capacitors and then checked out by a calibration lab).

Digital Voltmeter such as the DVM37 or DVM38.

Voltage source capable of outputs of .09 and .9 Volts DC.

1000 Hertz sine wave signal source variable to 4.0 Volts peak-to-peak.

Calibrated Scope such as the PS29 or PS163 to measure the amplitude of the 1000 Hertz signal.

METER CALIBRATION

See Warning on page 37!

The internal meter (readout) calibration should be checked and adjusted if necessary before calibration of any of the ranges of the "Z METER".

NOTE: Do not depress any of the pushbuttons on the "Z METER" when adjusting the meter zero on the rear or the meter calibration controls.

1. Turn the "Z METER" on and allow a 10 to 15 minute warm-up period.

2. If the readout does not show 000 with the negative sign appearing occasionally, adjust the rear panel meter zero control until the negative sign is just off or appears intermittently.

3. With the output control of the DC supply set to minimum, connect the positive lead to the ungrounded end of R1082. Connect the negative lead to the grounded end of R1082. Connect a DVM such as the VM37 or DVM38 to the same points. Adjust the power supply for a reading of 0.9 Volts DC across R1082.

4. Adjust R1035 on the "Z METER" for a readout of 900 on the display.

5. Reduce the power supply output to 0.09 Volts DC and adjust R1031 for a readout of 089 on the display.

6. Repeat steps 3, 4, and 5 two or three times as the controls will have some interaction.

INPUT PROTECTION RELAY TRIP POINT ADJUSTMENT *ADJ ONLY IF QUESTIONED*

The input protection relay trip point adjustment should be made before calibrating the other ranges of the LC53. The following procedure sets up the trip point at which the relay will open the input to the LC53 when an external voltage is applied to the test leads.

1. Connect a DVM to the sixth pin from the front panel on the LEAKAGE pushbutton, on the side of the switch closest to the outside of the instrument. This is accessible from the side of the instrument.

2. Connect a power supply set to 7 Volts DC capable of delivering 250 mA of current to the test leads. Connect the positive lead to the red test lead, the negative to the black test lead.

3. Adjust R1107 counterclockwise so that the DVM reads plus 7 Volts DC. Slowly rotate R1107 clockwise until the relay opens and the DVM reads 0 Volts. Then adjust R1107 counterclockwise until the voltage just returns.

INDUCTANCE CALIBRATION

The following procedure requires the use of standard inductors or inductors of known value. The inductors of known value must be close to the values shown in the procedure to insure that the proper range is calibrated. Each time a control is to be adjusted, the VALUE pushbutton must be depressed on the front panel.

1. Set all inductance cal pots to midrange (R1019, R1025, R1023, R1027, R1029, and R1070).

2. Connect the test leads to a standard 80 mH coil. Adjust R1025 for a readout of 80.0.

3. Connect the test leads to a standard 10 mH coil. Adjust R1070 for a readout of 10.0.

4. Repeat steps 2 and 3 at least two to three times as the controls will interact with each other. This sets the linearity of all the inductance ranges of the "Z METER" and calibrate the 10-100 mH range.

5. Short the test leads together, depress the VALUE button and adjust the front panel LEAD ZERO control for a readout of 000 with the negative sign appearing occasionally.

6. Connect the test leads to a standard 80 uH coil. Adjust R1019 for a readout of 80.0 uH.

7. Connect the test leads to a standard 800 uH coil. Adjust R1021 for a readout of 800 uH.

8. Connect the test leads to a standard 8 mH coil. Adjust R1023 for a readout of 8.00 mH.

9. Connect the test leads to a standard 800 mH coil. Adjust R1027 for a readout of 800 mH.

10. Connect the test leads to a standard 8 Henry coil. Adjust R1029 for a readout of 8000 mH.

RINGING TEST CALIBRATION *ONLY IF REQUIRED*

The calibration of the Ringing test is dependent upon the accuracy of the scope used to measure the 1000 Hertz sine wave input on the second half of the procedure.

1. Short the test leads together and set the IMPEDANCE MATCH switch to any one of the BLUE positions.

2. Connect a DVM to the collector of TR217.

3. Depress the RINGING TEST button and adjust R1081 for a 6.0 to 6.5 VDC reading.

4. Unshort the test leads. Set the IMPEDANCE MATCH switch to any one of the RED (Yoke & Flyback) positions. Connect the vertical input from a scope and the output of an audio generator to the input of the "Z METER". The input of the scope and the hot lead of the generator are connected to the red test clip and the ground leads to the black test clip.

5. Set the audio generator to sine wave and the frequency to 1000 Hertz.

6. Depress the RINGING TEST button and adjust the output of the audio generator for 3.6 Volts peak-to-peak.

7. Adjust R1054 with the RINGING TEST button depressed so the front panel display on the "Z METER" is counting. Slowly back off until the counting appears to be intermittent or the readout shows some number. The actual number is meaningless and only shows that you have reached the proper trip point in the ringing circuit. Carefully check that the point is the correct one by adjusting the control above and below the point to see that the counting starts and stops.

*DVM
RANGE
USE
100 uH
500 mH*

NO!

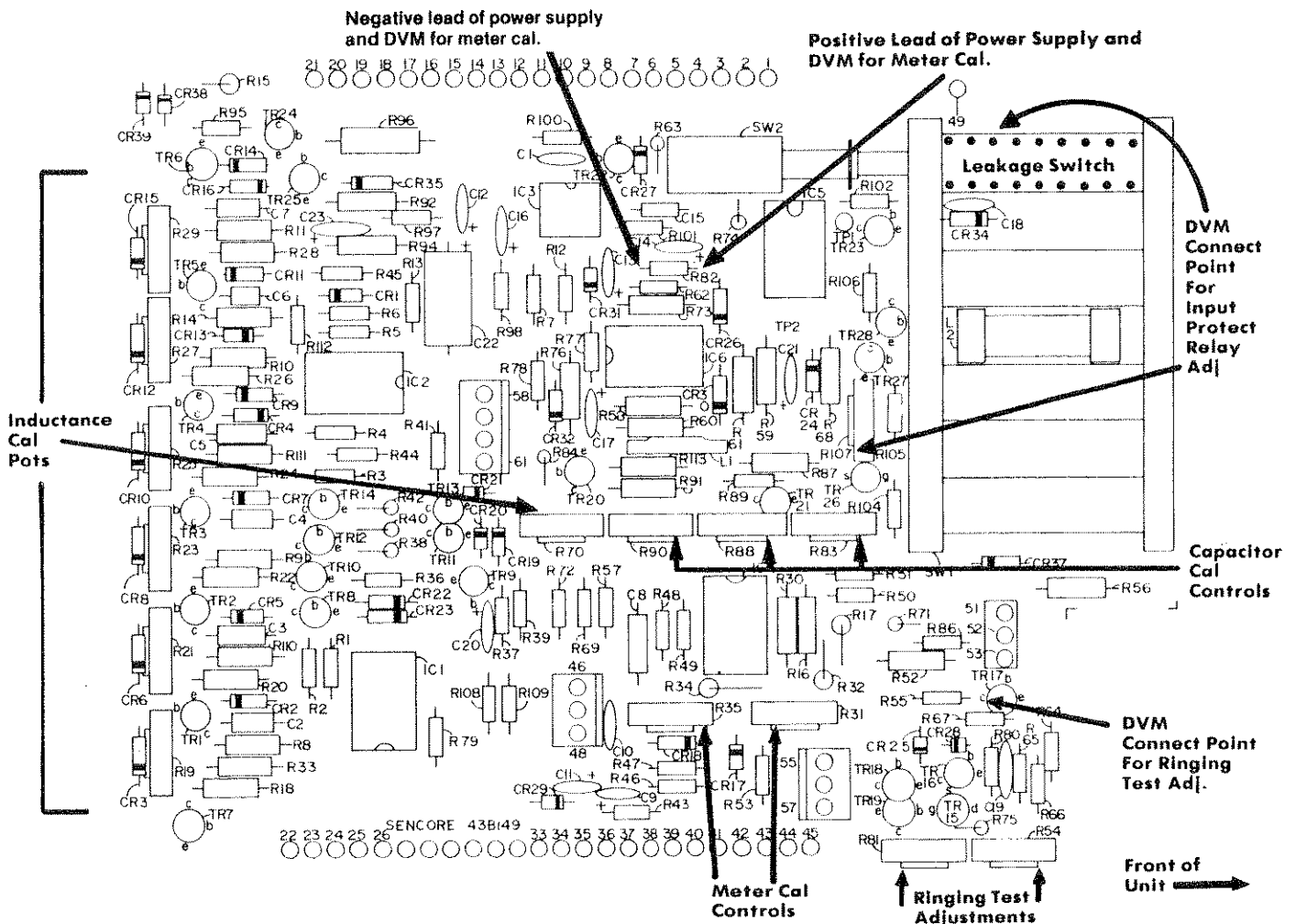

Fig. 26 — Component view of the 1000 board, 43B149 showing the location of the calibration controls and the point of connecting the DVM for the input relay trip point adjustment.

CAPACITOR CALIBRATION

Use of the standards listed in the beginning of the procedure are recommended. If calibration must be done with known value capacitors, be sure that the three capacitors are close in value to the ones recommended. Calibrate the meter to read the value of the capacitor used regardless of the value listed for the most accurate readings.

1. Short the test leads together and depress the VALUE button under INDUCTANCE. Check to see that the meter is zeroed. If not, reset the front panel LEAD ZERO control until the readout shows 000 with

the negative sign appearing occasionally. Do not touch the front panel LEAD ZERO again until after the next step.

2. Open the test leads and depress the VALUE button under CAPACITORS and adjust the internal capacity-inductance balance control R133 until the readout shows 000 with the negative sign appearing occasionally. This puts the inductance and capacitance lead zero at the same point on the front panel LEAD ZERO control.

3. Connect a standard 8000 pF capacitor to the test leads and depress the VALUE button under CAPACITORS.

4. Adjust R1083 for a readout of 8000 pF.

5. Connect a standard 0.8 uF capacitor to the test leads and depress the VALUE button under CAPACITORS.

6. Adjust R1088 for a readout of .800 uF.

7. Connect a standard 800 uF capacitor to the test leads and depress the VALUE button under CAPACITORS.

8. Adjust R1090 for a readout of 800 uF.

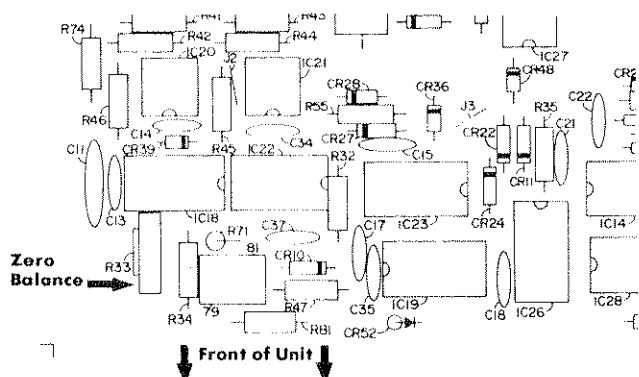

Fig. 27 — Component view of the corner of the 100 board showing the location of the lead zero balance control R133 and indicating the front of the unit or display board for a reference.

APPENDIX

CAPACITOR THEORY AND THE "Z METER"

The capacitor is one of the most common components used in electronics, but less is known about it than the other component in electronics. The following is a brief explanation of the capacitor, how it works, and how the "Z METER" measures the important parameters of the capacitor.

The basic capacitor is a pair of metal plates separated by an insulating material called the dielectric. The size of the plates, the type of dielectric, and the thickness of the dielectric determines the capacity. To increase capacity, you can increase the size of the plates, increase the number of plates, use a different dielectric or a thinner dielectric. The closer the plates, or the thinner the dielectric, the larger the capacity for a given size plate. Because flat plates are rather impractical, capacitors are generally made by putting an insulating material between two foil strips and rolling the combination into a tight package or roll.

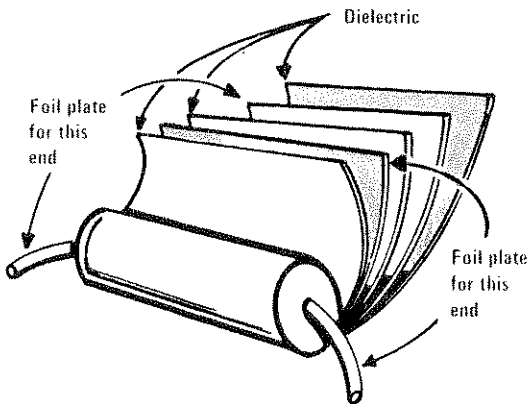

Fig. 28 — Most capacitors are made up of layers of foil separated by a dielectric and then rolled into a tight package.

The old explanation of how a capacitor works had the electrons piling up on one plate forcing the electrons off of the other to charge a capacitor. This made it difficult to explain other actions of the capacitor. Faraday's theory more closely approaches the way a capacitor really works. He stated that the charge is in the dielectric material and not on the plates of the capacitor. Inside the capacitor's dielectric material, there are tiny electric dipoles. When a voltage is applied to the plates of the capacitor, the dipoles are stressed and forced to line up in rows creating stored energy in the dielectric. The dielectric has undergone a physical change similar to that of soft iron when exposed to current through an inductor when it becomes a magnet. If we were able to remove the dielectric of a charged capacitor and then measure the voltage on the plates of the capacitor, we would find no voltage. Reinserting the dielectric and then measuring the plates, we would find the voltage that the capacitor had been charged to before we had removed the dielectric. The charge of the capacitor is actually

stored in the dielectric material. When the capacitor is discharged, the electric dipoles become re-oriented in a random fashion, discharging their stored energy.

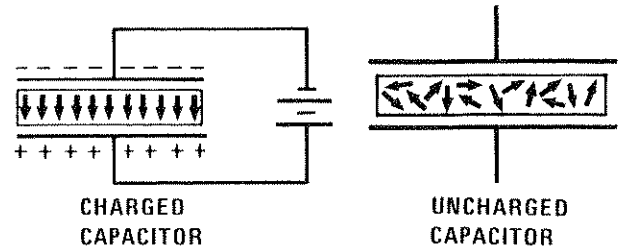

Fig. 29 — When a potential is applied to a capacitor, the dielectric dipoles in the dielectric line up in the direction of the applied potential. When the capacitor is discharged, the dipoles return to a random order and are not lined up.

When a capacitor is connected to a voltage source, it does not become fully charged instantaneously, but takes a definite amount of time. The time required for the capacitor to charge is determined by the size or capacity of the capacitor and the resistor in series with the capacitor or its own internal series resistance. This is called RC time and is capacity in Farads times resistance in Ohms equals time in seconds. The curve of the charge of the capacitor is the RC charge curve.

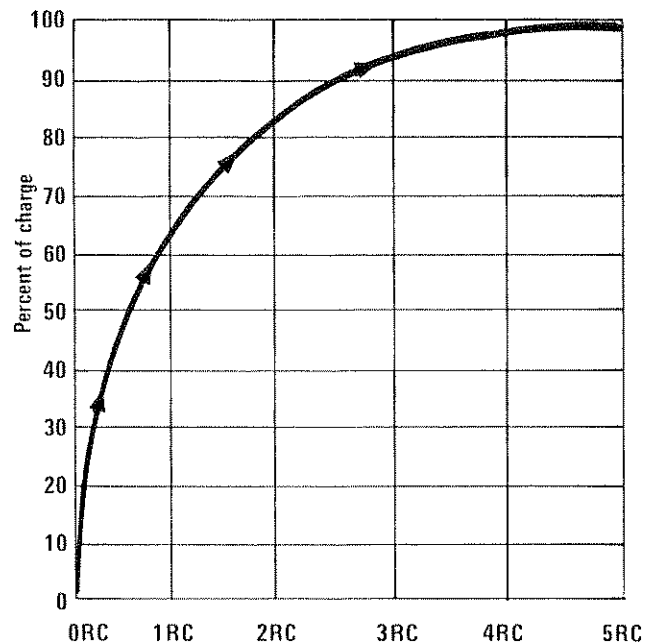

Fig. 30 — A capacitor does not charge up "instantaneously", it requires time. The time and rate of the charge is the RC charge time whose curve is shown here.

The "Z METER" makes use of this charge curve to measure the capacity of a capacitor. By applying a

pulsating DC voltage to the capacitor under test and measuring the time on its RC charge curve, the capacity of the capacitor can be determined very accurately.

Paper and mica were for years the standard dielectric materials for capacitors. Ceramic became popular due to its stability and controlled characteristics and lower cost over mica. Today, there are many new dielectrics with different ratings and uses in capacitors. Paper is still used today. It is impregnated with a wax or special oil to reduce the air pockets and the moisture absorption of the paper.

Plastic films of Polyester, Polycarbonate, Polystyrene, Polypropylene, and Polysulfone are used in many of the newer large value, small size capacitors. Each film has its own special characteristics and is chosen to be used in the circuit for this special feature. Some of the plastic films are also metalized by vacuum plating the film with a metal. These are generally called self-healing type capacitors and should not be replaced with any other type.

Ceramic dielectric is the most versatile of all. Many variations of capacity can be created by altering the ceramic material. Capacitors that increase, stay the same value, or decrease value with temperature changes can be made. If a ceramic disc is marked with a letter P such as P100, then the value of the capacitor will increase 100 parts per million per degree centigrade increase in temperature. If the capacitor is marked NPO or COG, then the value of capacity will remain constant with an increase in the temperature.

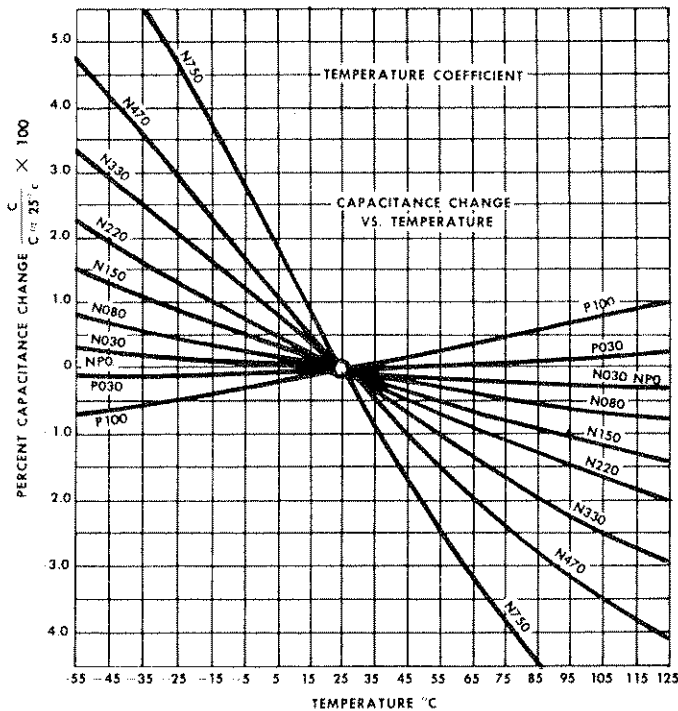

Fig. 31 — Temperature change versus capacity change of P100 to N750 Temperature compensated ceramic disc capacitors.

Ceramic disc capacitors marked with an N such as N1500 will decrease in capacity as the temperature increases. The negative temperature coefficient is

important in many circuits such as the tuned circuits of the radio and television IF. The temperature coefficient of an inductor is positive and the inductance will increase as the temperature rises. If the tuning capacitor across the coil is a negative coefficient, then the net result will be a zero or very little change.

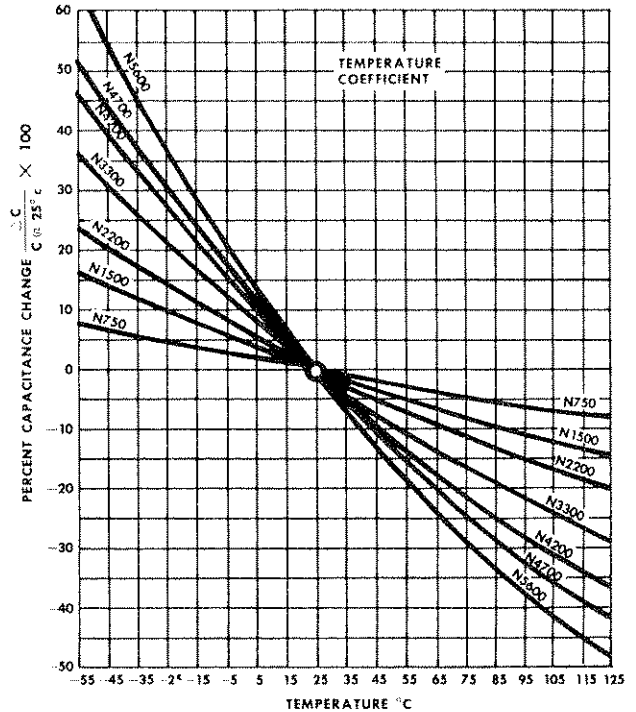

Fig. 32 — Temperature change versus capacity change of N750 to N5600 Temperature compensated ceramic disc capacitors.

General type ceramic discs are often marked with such letters as Z5U, Z5F, Y5V, X5V, and so forth. This indicates the type of temperature curve for that particular capacitor. Ceramic capacitors that are not NPO or rated with N or P type characteristics will have wider temperature variations and can vary both positive and negative with temperature changes. The Z5U probably has the greatest change and will only be found in non-critical applications such as bypassing of B+ points. These type of capacitors should not be used in critical applications such as oscillator and timing circuits.

A ceramic capacitor marked GMV means that the marked value on the capacitor is the Guaranteed Minimum Value of capacity at room temperature. The actual value of the capacitor can be much higher. This type of capacitor is used in bypass applications where the actual value of capacity is not critical.

Ceramic capacitors have been the most popular capacitors in electronics because of the versatility of the different temperature coefficients and the cost. When replacing a ceramic disc capacitor, be sure to replace the defective capacitor with one having the same characteristics and voltage rating.

The aluminum electrolytic capacitor or "Lytic" is a very popular component. A large value capacity in a small case can be obtained quite easily. The aluminum electrolytic is used in power supply filtering, audio, and video coupling and in bypass applications. Anywhere a large

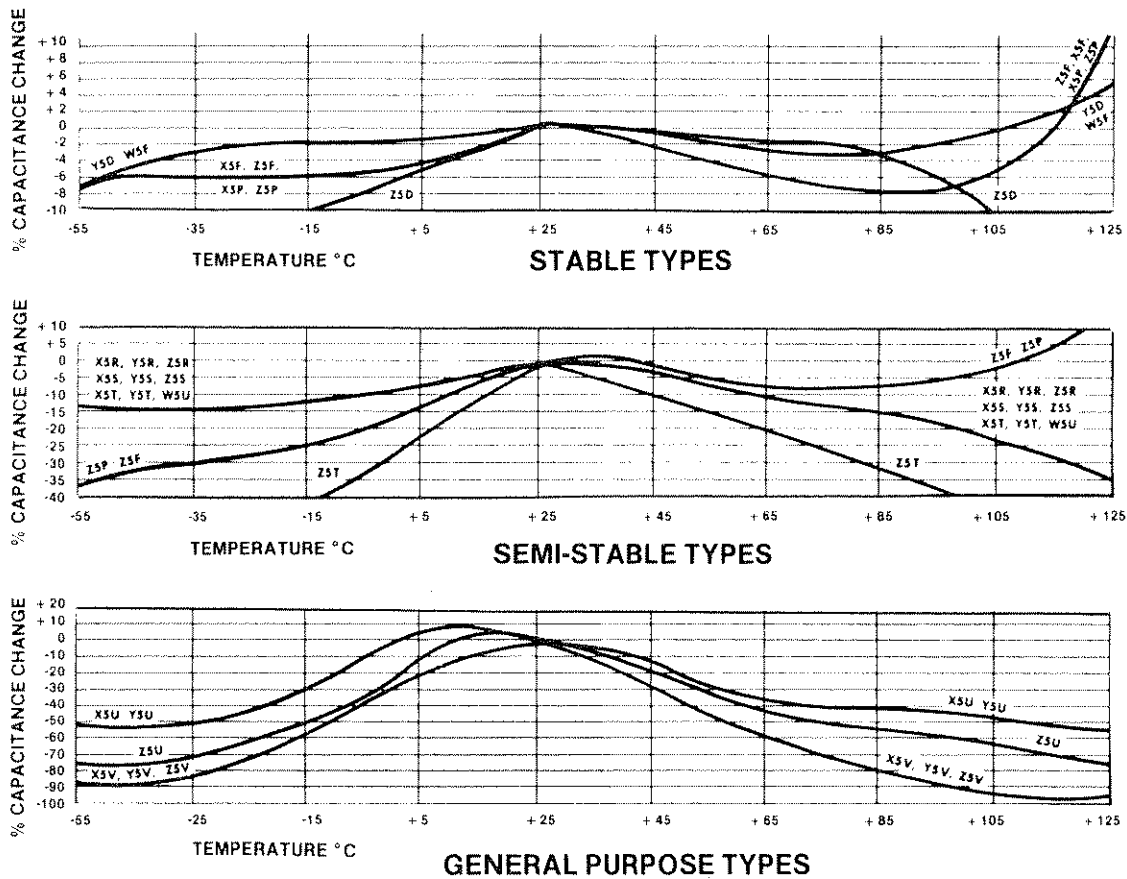

Fig. 33 — Temperature change versus capacity change of Non-Temperature compensated ceramic disc capacitors.

value of capacity is required with a small space availability, the lytic fits right in.

The aluminum lytic is made by using a pure aluminum foil wound with a paper soaked in a liquid electrolyte. When a voltage is applied to the combination, a thin layer of oxide film forms on the pure aluminum forming the dielectric. As long as the electrolyte remains liquid, the capacitor is good or can be reformed after sitting for a while. When the electrolyte dries out, the leakage goes up and the capacitor loses capacity. This can happen to aluminum lytics just sitting on the shelf. When an aluminum lytic starts drying out, the capacitor begins to show dielectric absorption.

Although the aluminum electrolytic is very popular, the tantalum lytic is gaining ground. Just a short time ago, the tantalum lytic was very high in cost compared to the aluminum lytic, but mass production technology has brought the cost down on tantalum lytics. The leakage in the aluminum lytic is very high due to the nature of its construction. The tantalum, on the other hand, is very low in leakage and can be constructed with much tighter tolerances than the aluminum lytic. The tantalum is also much smaller in size for the same capacity and working voltage than an aluminum lytic. Tantalum lytics have become very popular in timing circuits and for critical coupling where high capacity is required with low leakage. The capacity of the tantalum lytic is limited and for extremely large values of capacity for power supply filtering, the aluminum lytic is still the first choice.

There are many different types of capacitors, using different types of dielectrics, each with its own best capability. When replacing capacitors, it is best to replace with a capacitor having not only the same capacity and tolerance, but the same type of dielectric and temperature characteristics as well. This will insure of continued performance equal to the original.

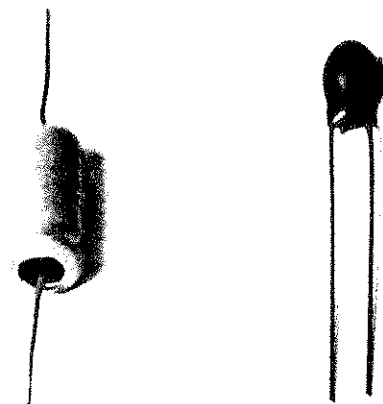

Fig. 34 — The tantalum lytic, shown on the right, is much smaller in size than the aluminum lytic for the same capacity and working voltage.

The "Z METER" will measure leakage in the dielectric of a capacitor and will also show dielectric absorption. The DC leakage is measured in two ranges with the value displayed on the digital readout in microamps.

Dielectric absorption will show up mostly in electrolytics as a changing capacitor value. If the capacitor is checked for leakage and then checked for value, the meter will show a lower value capacitor at first and then the reading will increase slowly upward. This indicates that the electric dipoles in the dielectric are resisting the discharge of the capacitor and remaining polarized in the dielectric. This is dielectric absorption and sometimes called capacitor memory. It can also be referred to as battery action of a capacitor. What is actually happening is that the small voltage from the dielectric absorption is changing the RC charge curve and making the meter see a smaller value of capacitor. As the test continues, the dielectric charge or memory is slowly dissipated in the charge and recharge of the capacitor, increasing the length of the RC charge curve and allowing the meter to read a higher and higher value capacitor. This indicates that the electrolyte is drying out in an electrolytic capacitor which will indicate a future problem with this component. Dielectric absorption will not normally show up in film or ceramic capacitors, but if it does show up with the "Z METER", then the capacitor is a suspect. This will generally be associated with a high leakage as well.

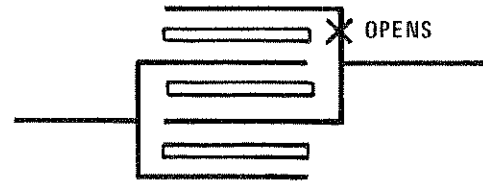

Fig. 36 — On multi-layer foil capacitors, a break in one of the foil connections to the lead can cause a reduction of capacity.

Capacitors can change value. On some multi-layer foil capacitors, poor welding or soldering of the foil to the leads can cause an open to one of the foils at a later date due to stress of voltage or temperature. These type can lose almost one-half of their rated or marked capacity. Ceramic disc capacitors can also change value by a small value or a large value depending upon where a fissure or crack is located. Small fissures or cracks in the ceramic insulating material can be created by thermal stress or exposure to heat and cold. Sometimes very small fissures can be created and then not effect the capacitor until much later. Note that the crack will reduce the capacitor to a smaller value. Although the ceramic is still connected to the leads, the actual value of capacity could be a very small portion of the original value depending upon where the crack occurs. The "Z METER" will let you know what the value of the capacitor is regardless of its marked value.

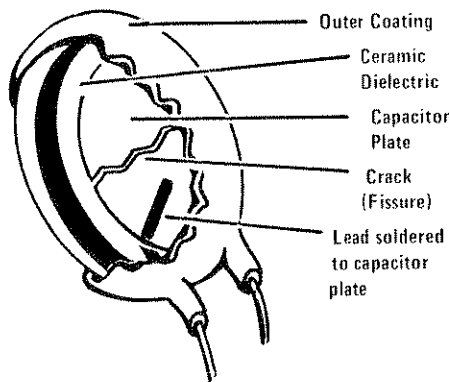
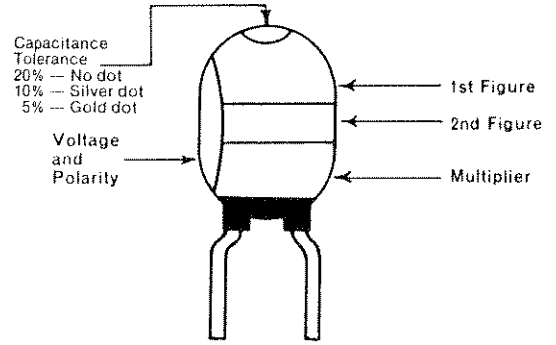

Fig. 35 — A ceramic disc is made up of the ceramic dielectric coated with silver for the plates and then covered with a protective coating. Sometimes a crack or fissure can occur in the dielectric material large enough to reduce the value of capacity.

Dipped Tantalum Capacitors

Color	Rated Voltage	Capacitance in Picofarads		Multiplier
		1st Figure	2nd Figure	
Black	4	0	0	—
Brown	6	1	1	—
Red	10	2	2	—
Orange	15	3	3	—
Yellow	20	4	4	10,000
Green	25	5	5	100,000
Blue	35	6	6	1,000,000
Violet	50	7	7	10,000,000
Gray	—	8	8	—
White	3	9	9	—



Ceramic Disc Capacitors

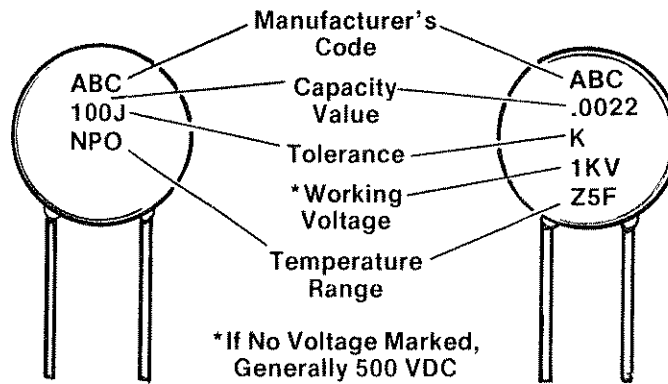

Typical Ceramic Disc Capacitor Markings

Low Temp.	Letter Symbol	High Temp.	Numerical Symbol	Max. Capac. Change Over Temp. Range	Letter Symbol
+ 10°C	Z	+ 45°C	2	+ 1.0%	A
-30°C	Y	+ 65°C	4	± 1.5%	B
-55°C	X	+ 85°C	5	± 1.1%	C
		+ 105°C	6	± 3.3%	D
		+ 125°C	7	± 4.7%	E
				± 7.5%	F
				± 10.0%	P
				± 15.0%	R
				± 22.0%	S
				+ 22%, -33%	T
				+ 22%, -56%	U
				+ 22%, -82%	V

1st & 2nd Fig. of Capacitance	Multiplier	Numerical Symbol	Tolerance on Capacitance	Letter Symbol
	1	0		
	10	1		
	100	2	± 5%	J
	1,000	3	± 10%	K
	10,000	4	± 20%	M
	100,000	5	+ 100%, -0%	P
		—	+ 80%, -20%	Z
		—		
	.01	8		
	.1	9		

Temperature Range Identification of Ceramic Disc Capacitors

Capacity Value and Tolerance of Ceramic Disc Capacitors

Film Type Capacitors

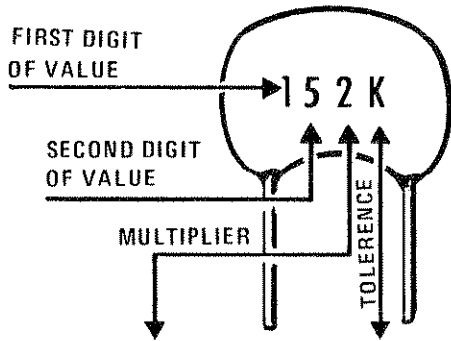

MULTIPLIER		TOLERANCE OF CAPACITOR		
For the Number	Multiplier	Letter	10 pF or Less	Over 10 pF
0	1	B	± 0.1 pF	
1	10	C	$\pm .25$ pF	
2	100	D	± 0.5 pF	
3	1,000	F	± 1.0 pF	$\pm 1\%$
4	10,000	G	± 2.0 pF	$\pm 2\%$
5	100,000	H		$\pm 3\%$
8	0.01	J		$\pm 5\%$
		K		$\pm 10\%$
9	0.1	M		$\pm 20\%$

EXAMPLES:

152K = $15 \times 100 = 1500$ pF or .0015 uF, $\pm 10\%$

759J = $75 \times 0.1 = 7.5$ pF, $\pm 5\%$

NOTE: The letter "R" may be used at times to signify a decimal point; as in: 2R2 = 2.2 (pF or uF).

Ceramic Feed Through Capacitors

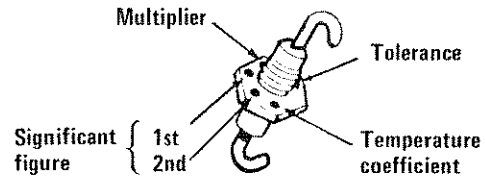

Color	Significant Figure	Multiplier	Tolerance 10 pF or Less Over 10 pF	Temperature Coefficient
Black	0	1	2 pF	0
Brown	1	10	0.1 pF	N30
Red	2	100	—	N60
Orange	3	1,000	—	N150
Yellow	4	10,000	—	N220
Green	5	—	5 pF	N330
Blue	6	—	—	N470
Violet	7	—	—	N750
Gray	8	0.001	0.025 pF	P30
White	9	0.1	1 pF	+ 120 to -750 (RETMA) + 500 to -330 (JAN)
Gold	—	—	—	P100
Silver	—	—	—	Bypass or coupling

Postage Stamp Mica Capacitors

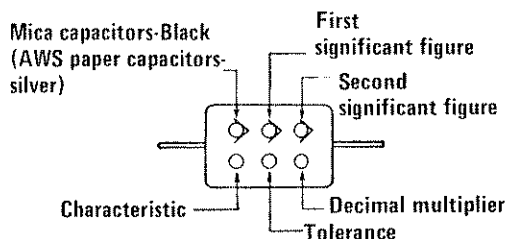

AWS and JAN fixed capacitors
(First dot silver or black)

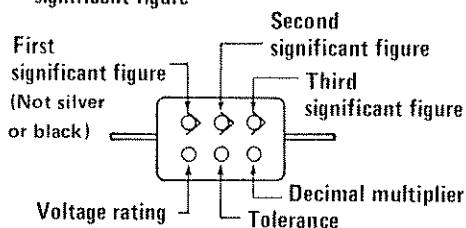
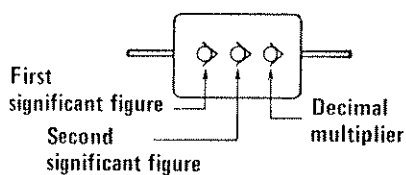

Color	Significant Figure	Multiplier	Tolerance (%)	Voltage Rating
Black	0	1	—	—
Brown	1	10	1	100
Red	2	100	2	200
Orange	3	1,000	3	300
Yellow	4	10,000	4	400
Green	5	100,000	5	500
Blue	6	1,000,000	6	600
Violet	7	10,000,000	7	700
Gray	8	100,000,000	8	800
White	9	1,000,000,000	9	900
Gold	—	0.1	5	1000
Silver	—	0.01	10	2000
No color	—	—	20	500

Standard Button Mica

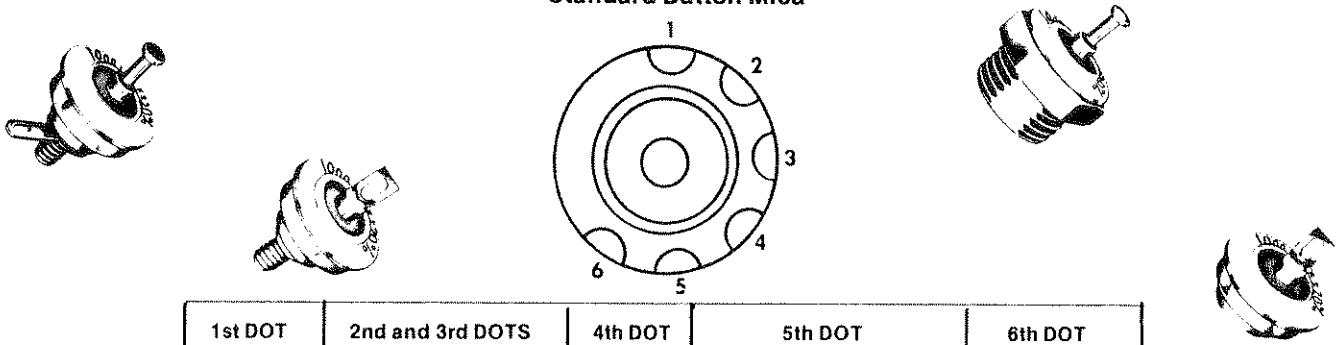

1st DOT	2nd and 3rd DOTS		4th DOT	5th DOT		6th DOT	
Identifier	Capacitance in pF		Multiplier	Capacitance Tolerance		Temp. Characteristic	
	Color	1st & 2nd Sig. Figs.		Percent	Letter Symbol		
Black	Black	0	1	± 20%	F		
	Brown	1	10	± 1%	F		
NOTE: Identifier is omitted if capacitance must be specified to three significant figures.	Red	2	100	± 2% or ± 1 pF	G or B		
	Orange	3	1000				
	Yellow	4				+ 100	
	Green	5					
	Blue	6				-20 PPM/°C	
	Violet	7				above 50 pF	
	Gray	8	0.1			± 100 PPM/°C	
	White	9			± 5%		J
	Gold				± 10%		K
	Silver					below 50 pF	

Radial or Ayal Lead Ceramic Capacitors (6 Dot or Band System)

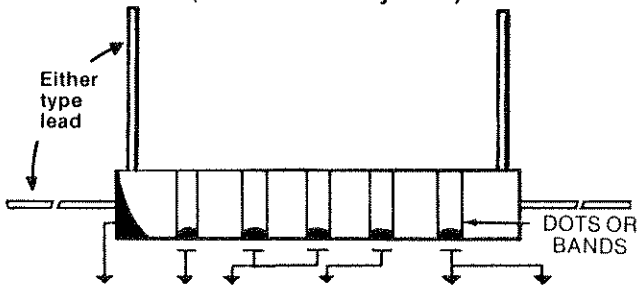

5 Dot or Band Ceramic Capacitors

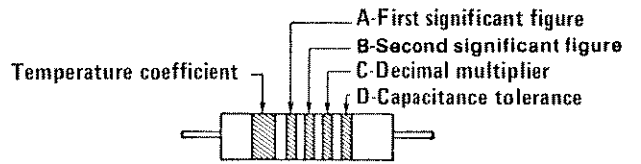

Fixed ceramic capacitors, 5 dot or band system

Color Code for Ceramic Capacitors

Temp. Coefficient	Capacitance					Nominal Capacitance Tolerance		
	1st Color	2nd Color	1st and 2nd Sig. Fig.	Multiplier	Color	10 pF or Less	Over 10 pF	Color
P100	Red	Violet	0	1	Black	± 2.0 pF	± 20%	Black
P030	Green	Blue	1	10	Brown	± 0.1 pF	± 1%	Brown
NP0	Black	Brown	2	100	Red		± 2%	Red
			3	1,000	Orange		± 3%	Orange
N080	Red		4	10,000	Yellow	± 0.5 pF	+ 100% -0%	Yellow
N150	Orange		5		Green		± 5%	Green
N220	Yellow	Green	6		Blue			Blue
			7		Violet			Violet
N470	Blue	Violet	8	.01	Gray	± 0.25 pF	+ 80% -20%	Gray
			9	.1	White	± 1.0 pF	± 10%	White
N1500	Orange	Orange						
N2200	Yellow	Orange						
N3300	Green	Orange						
N4200	Green	Green						
N4700	Blue	Green						
					Orange			
N5600	Green	Black						
N330 ± 500	White							
N750 ± 1000	Gray							
N3300 ± 2500	Gray	Black						

Color	1st & 2nd Significant Figure	Multiplier	Capacitance Tolerance		Temp. Coeff.
			Over 10 pF	10 pF or Less	
Black	0	1	± 20%	2.0 pF	0
Brown	1	10	± 1%		N30
Red	2	100	± 2%		N80
Orange	3	1000			N150
Yellow	4				N220
Green	5				N330
Blue	6		± 5%	0.5 pF	N470
Violet	7				N750
Gray	8	0.01		0.25 pF	P 30
White	9	0.1	± 10%	1.0 pF	P500

Notes

GLOSSARY

Aging — operating a component or instrument at controlled conditions for time and temperature to screen out weak or defective units and, at the same time, stabilize the good units.

Anode — the positive electrode of a capacitor.

Capacitance — the measure of the size of a capacitor. Usually expressed in microfarads and picofarads. Determined by the size of the plates, and the dielectric material.

Capacitive reactance — the opposition to the flow of a pulsating DC voltage or AC voltage. Measured in ohms.

Capacitor — an electronic component consisting of two metal plates separated by a dielectric. Can store and release electrical energy, block the flow of DC current or filter out or bypass AC currents.

Cathode — the negative electrode of a capacitor.

Charge — the quantity of electrical energy stored or held in a capacitor.

Clearing — the removal of a flaw or weak spot in the dielectric of a metalized capacitor. The stored energy in the capacitor vaporizes the material in the immediate vicinity of the flaw. Also called self-healing or self-clearing.

COG — same as NPO. Very small capacity change for large temperature changes.

Coil — an inductor wound in a spiral or circular fashion. Can be wound on a form or without a form such as an air coil.

CV product — the capacitance of a capacitor multiplied by its working voltage. Used when determining the leakage allowable in electrolytic capacitors. The CV product is also equal to the charge that a capacitor can store at its maximum voltage.

Dielectric — the insulating or non-conducting material between the plates of a capacitor. Typical dielectrics include air, impregnated paper, plastic films, oil, mica, and ceramic.

Dielectric absorption — the measure of the reluctance of a capacitor to completely discharge. The charge that remains after a determined discharge time is expressed in a percentage of the original charge. Can also be called "Capacitor Memory" or "Battery Action".

Dielectric constant — the ratio of capacitance between a capacitor having a dry air dielectric and the given material. A figure for determining the efficiency of a given dielectric material. The larger the dielectric constant, the greater the capacity with a given size plate.

Disc capacitor — a small single layer ceramic capacitor consisting of disc of ceramic insulator with silver deposited on both sides as the plate. The ceramic material can be of different compositions to give different temperature curves to the capacitor.

Dissipation factor (DF) — the ratio of the effective series resistance of a capacitor compared to its reactance at a given frequency, generally given in percent.

Electrolyte — a current conducting liquid or solid between the plates or electrodes of a capacitor with at least one of the plates having an oxide or dielectric film.

Electrolytic capacitor (aluminum) — a capacitor consisting of two conducting electrodes of pure aluminum, the anode having an oxide film which acts as the dielectric. The electrolyte separates the plates.

Equivalent series resistance (ESR) — used in capacitor calculations. All internal series resistances of a capacitor are lumped into one resistor and treated as one resistor at one point in the capacitor.

Farad — the measure or unit of capacity. Too large for electronic use and is generally measured in microfarads or picofarads.

Fissures — cracks in the ceramic dielectric material of disc capacitor, most often caused by thermal shock. Some small fissures may not cause failure for a period of time until exposed to great thermal shock or mechanical vibration for a period of time.

Fixed capacitor — a capacitor designed with a specific value of capacitance that cannot be changed.

Gimmick — a capacitor formed by two wires or other conducting materials twisted together or brought into close proximity of each other.

GMV — Guaranteed Minimum Value. The smallest value this ceramic capacitor will have. Its value could be much higher.

Henry — The unit of the measure of inductance. Also expressed in microhenry and millihenry.

Inductor — a device consisting of one or more windings with or without a magnetic material core or introducing inductance into a circuit.

Inductance — the property of a coil or transformer which induces an electromagnetic force in that circuit or a neighboring circuit upon application of an alternating current.

Inductive reactance — the opposition of an inductor to an alternating or pulsating current.

Impedance — the total opposition of a circuit to the flow of an alternating or pulsating current.

Insulation resistance — the ratio of the DC working voltage and the resulting leakage current through the dielectric. Generally a minimum value is specified, usually in the several thousand megohms range.

Iron core — the central portion of a coil or transformer. Can be a powdered iron core as in small coils used in RF to the large iron sheets used in power transformers.

Leakage current — stray direct current flowing through the dielectric or around it in a capacitor when a voltage is applied to its terminals.

Metalized capacitor — one in which a thin film of metal has been vacuum plated on the dielectric. When a breakdown occurs, the metal film around it immediately burns away. Sometimes called a self-healing capacitor.

Monolithic ceramic capacitor — a small capacitor made up of several layers of ceramic dielectric separated by precious metal electrodes.

Mutual inductance — the common property of two inductors whereby the induced voltage from one is induced into the other. The magnitude is dependent upon the spacing.

NPO — an ultra stable temperature coefficient in a ceramic disc capacitor. Derived from "negative-positive-zero". Does not change capacity with temperature changes.

Padder — a high capacity variable capacitor placed in series with a fixed capacitor to vary the total capacity of the circuit by a small amount.

Power factor — the ratio of the effective resistance of a capacitor to its impedance.

Reactance — the opposition of a capacitor or inductor to the flow of an AC current or a pulsating DC current.

Self-healing — term used with metalized foil capacitors.

Solid tantalum capacitor — an electrolytic capacitor with a solid tantalum electrolyte instead of a liquid. Also called a solid electrolyte tantalum capacitor.

Surge voltage — the maximum safe voltage in peaks to which a capacitor can be subjected to and remain within the operating specifications. This is not the working voltage of the capacitor.

Temperature coefficient (TC) — the changes in capacity per degree change in temperature. It can be positive, negative, or zero. Expressed in parts per million per degree centigrade for linear types. For non-linear types, it is expressed as a percent of room temperature.

Time constant — the number of seconds required for a capacitor to reach 63.2% of its full charge after a voltage is applied. The time constant is the capacity in farads times the resistance in ohms is equal to seconds ($T=RC$).

Trimmer — a low value variable capacitor placed in parallel with a fixed capacitor of higher value so that the total capacity of the circuit may be adjusted to a given value.

Variable capacitor — a capacitor that can be changed in value by varying the distance between the plates or the useful area of its plates.

Voltage rating — see working voltage.

Wet (slug) tantalum capacitor — an electrolytic capacitor having a liquid cathode.

Working voltage — the maximum DC voltage that can be applied to a capacitor for continuous operation at the maximum rated temperature.

Notes