

TRIPPLET



Instruction Manual
Model 625-NA
Volt-Ohm-Milliammeter

MANUAL ONLY • \$1.25

TABLE OF CONTENTS

	Page
Ranges & General Description	3
Operation Instructions	4
General	4
Volts DC-AC	4-5
Ohms	6
Milliamperes Measurement	7
Amperes	7
Decibels	7
Microfarads	8-9
Operation Chart	10-11
Maintenance	12-13
Wiring Diagram	14
Parts Location	15
Replaceable Parts	16-17
Warranty	18

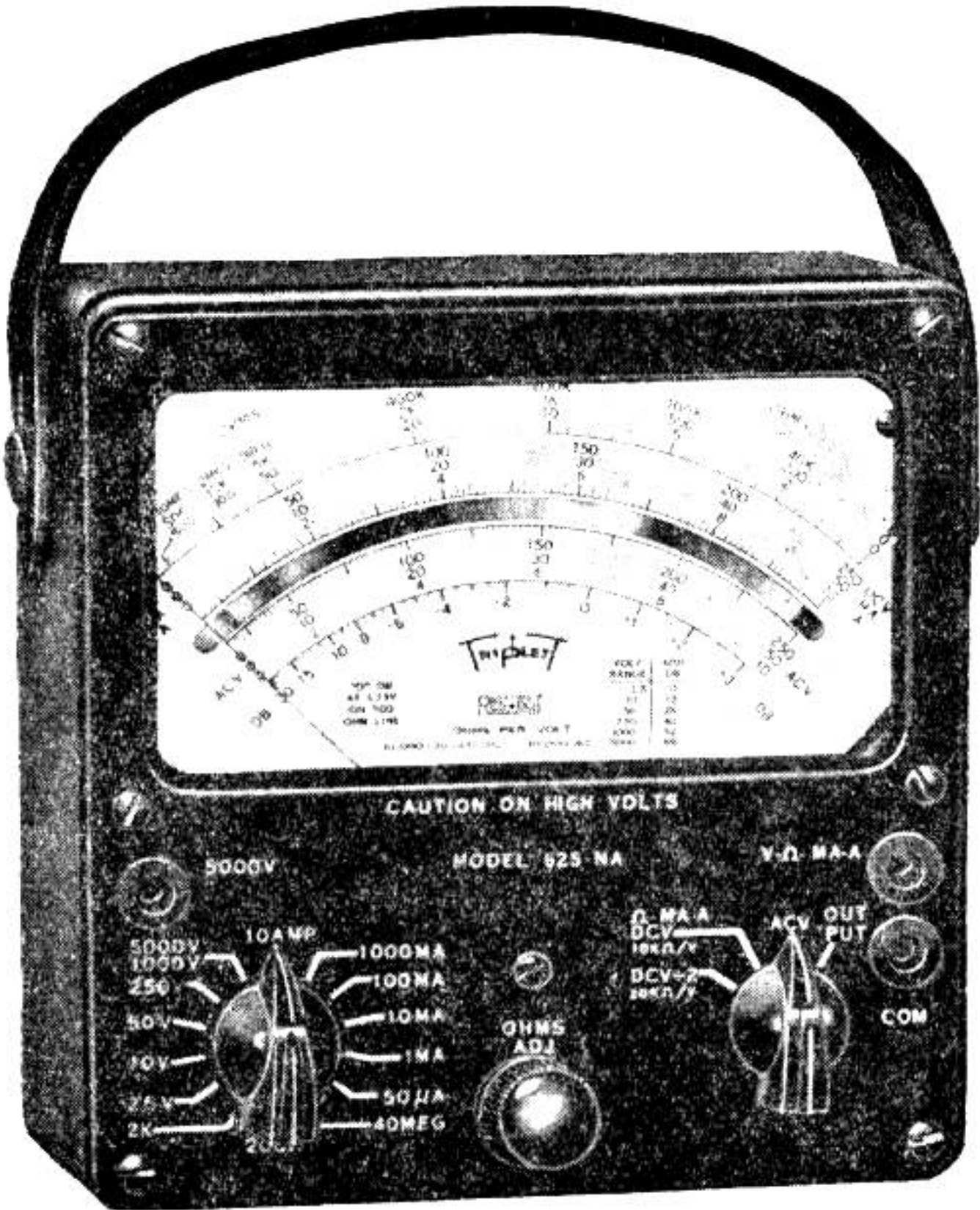

Model 625-NA

RANGES

- D.C. Volts:** 0-1.25-5-25-125-500-2500, at 20,000 ohms per volt.
0-2.5-10-50-250-1000-5000, at 10,000 ohms per volt.
- A.C. Volts:** 0-2.5-10-50-250-1000-5000, at 10,000 ohms per volt.
- D.C. Microamperes:** 0-50, at 250 millivolts.
- D.C. Milliamperes:** 0-1-10-100-1000, at 250 millivolts.
- D.C. Amperes:** 0-10, at 250 millivolts.
- Ohm:** 0-2000-200,000
.....(12-1200 at center scale)
- Megohm:** 0-40
.....(240,000 Ohms at center scale)
- Decibels:** -20, +10, +22, +36, +50, +62, +76 on 600 Ohm line at 1Mw.
- Output:** Condenser in series with A.C. Volt ranges.

GENERAL DESCRIPTION

- Instrument**—6" 0-50 Microamps.
- Mirror Scale**—for excellent readability. Black markings on white except AC are red and OHMS are green on white.
- Molded, Insulated Case**—Black molded 2½" x 5½" x 6". Removable strap handle.
- Panel**—Black molded with white markings.
- Batteries**—Self-contained, One 15 V. Minimax Eveready No. 411; one 1.5 V. No. 935 Eveready, or equivalent.
- Weight**—3 lbs.



Operating Instructions

for 625-NA

Volt-Ohm-Milliammeter

GENERAL DESCRIPTION

The Model 625-NA Volt-Ohm-Milliammeter is a long scale multi-range instrument in a compact portable case. It provides the ranges commonly used in servicing radio and TV receivers as well as those used in the experimental laboratory or at a radio transmitting station.

The selection of all ranges except 5000V is obtained by rotating the two bar knobs on the front of the panel. The Selector Switch knob is on the left side of panel. The 5000 AC or DC volt ranges require changing jack connections in addition to setting the switches. The red jacks are the positive leads for DC, and the "COM" is always negative.

The "Range Switch" is more or less self explanatory.

The "Selector Switch" requires a little more explanation. Position No. 1 (DCV \div 2, 20K Ω /V) indicates you divide the scale reading by 2 according to the position of the range switch setting, etc. If the range switch is on 50V, the selector switch on (DCV \div 2, 20K Ω /V) position and your meter reads 30 on the 50V scale, the true voltage would be 15 volts. With this feature you

OHMS

Connect test leads together and adjust "OHMS ADJ." for full scale deflection before measuring ohms. This ohms control adjusts for variations in voltage of the self-contained batteries. The "K" on the dial designates 1000. Follow the Operation Chart as noted.

Condensers may be checked for shorts or leakage resistance with the ohm ranges. *Discharge Condensers Before Making Test.* The tests are made at 1.5 volts on the "2K" and "200K" ohm ranges, and at 15 volts on the "40 MEG" range.

To extend the ohm range from 0-40 megohms to 0-400 megohms, connect a 150 volt battery and a 2.2 megohm resistor in series with one of the test leads. Figure 1. Set Range switch to "40 MEG", adjust ohms control and read on 0-40 megohm scale multiplied by 10.

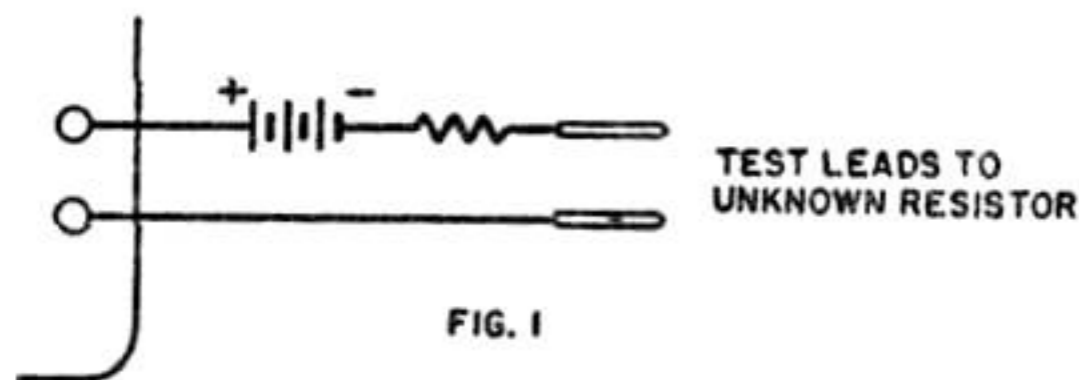

MILLIAMPERE MEASUREMENTS

Do not test directly across any potential circuits when on milliampere ranges as this may burn out the instrument and shunt.

RESISTANCE MEASUREMENTS

Under no condition apply voltage between leads when on ohmmeter position as the instrument will thereby be overloaded and damaged.

AMPERES

For 0-10 Amp DC, see Operation Chart.

Plug the desired external 250 millivolt shunt into the "Com" and the "V-O-MA-A" jacks and set the range switch on the 10 Ma. position. Connect the test leads or the line to be measured to the binding posts on the shunt. Triplett plug-in shunts are not supplied with the tester but may be obtained to special order.

MEASURING OUTPUT VOLTS (DB)

Output is generally measured in units called the decibel, a terminology used to indicate power levels in amplifiers or telephone work.

Do not confuse the DB with the VU (Volume Unit). The VU is based on .001

watt dissipated in a 600 ohm line and is measured with a meter having special ballistic characteristics.

Rotate the selector switch to the appropriate AC volt range. Refer to the small chart on the meter dial for the range to use. Always start with the highest range if in doubt as to the approximate number of decibels.

MICROFARADS

Set right hand Selector Switch to "ACV" and connect a 0.5 mfd. condenser across the "Com" and the "V-O-MA-A" jacks. Connect this combination in series with the unknown condenser and a 110 volt 60 cycle line as shown in Figure 2. Read capacitance as noted below on the 0-10 "ACV" scale.

CAUTION: This test is for paper condensers only!

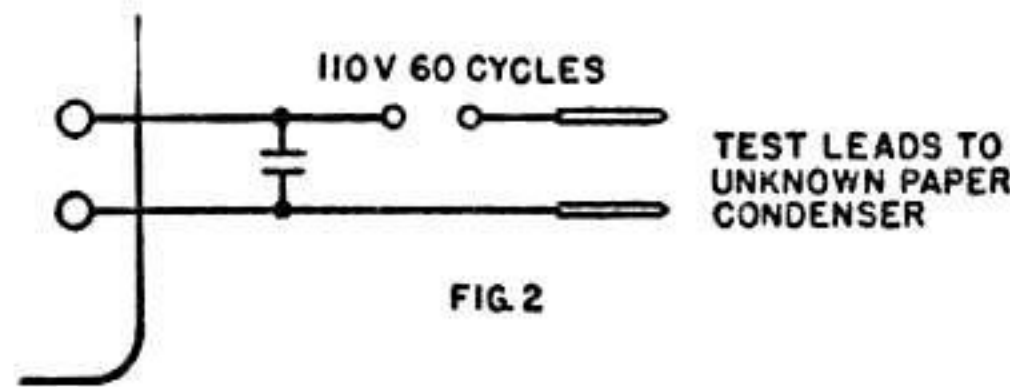

MODEL 625-NA EXTERNAL CONNECTIONS

TO MEASURE MFD.	SET LEFT HAND RANGE SWITCH TO	DEFLECTION ON RED 0-10 "ACV" SCALE
.002	2.5V	1.65
.004		3.05
.006		4.65
.008		6.15
.010		7.80
.012		9.60
.020	10.0V	4.50
.04		7.80
.05		9.90
.08	50V	3.00
0.10		3.70
0.2		6.30
0.4		9.60
0.6	250V	2.45
0.8		2.70
1.0		2.95
2.0		3.50
4.0		3.90
6.0		4.10
10.0		4.25

OPERATION CHART

TO MEASURE	SET RIGHT HAND SELECTOR SWITCH TO	SET LEFT HAND RANGE SWITCH TO	USE BLACK JACK	USE RED JACK	READ ON	EACH SCALE DIV. EQUALS
10,000Ω/V	ΩMA-A DCV 10,000Ω/V	2.5 V	Com	V-O-MA-A	BLACK SCALE	
0-2.5 Volts DC		10 V			0-250 DC÷100	0.025 Volt
0-10 Volts DC		50 V			0-10 DC×1	0.10 Volt
0-50 Volts DC		250 V			0-50 DC×1	0.5 Volt
0-250 Volts DC		1000-5000 V			0-25 DC×1	2.5 Volts
0-1000 Volts DC		1000-5000 V			0-10 DC×100	10 Volts
0-5000 Volts DC			Com	5000V	0-10 DC×500	50 Volts
20,000Ω/V	DCV÷2 20,000Ω/V	2.5 V	Com	V-O-MA-A	BLACK SCALE	
0-1.25 Volts DC		10 V			0-250 DC÷200	0.0125 Volt
0-5 Volts DC		50 V			0-50 DC÷10	0.05 Volt
0-25 Volts DC		250 V			0-250 DC÷10	0.025 Volt
0-125 Volts DC		1000-5000 V			0-250 DC÷2	1.25 Volt
0-500 Volts DC		1000-5000 V			0-50 DC×10	5 Volts
0-2500 Volts DC			Com	5000V	0-250 DC×10	25 Volts
10,000Ω/V	ACV	2.5 V	Com	V-O-MA-A	RED SCALE	
0-2.5 Volts AC		10 V			0-250 AC÷100	0.025 Volt
0-10 Volts AC		50 V			0-10 AC×1	0.10 Volt
0-50 Volts AC		250 V			0-50 AC×1	0.5 Volt
0-250 Volts AC		1000-5000 V			0-250 AC×1	2.5 Volts
0-1000 Volts AC		1000-5000 V			0-10 AC×100	10 Volts
0-5000 Volts AC			Com	5000V	0-50 AC×100	50 Volts
0-50 UA DC	ΩMA-A DCV 10,000Ω/V	50 UA	Com	V-O-MA-A	BLACK SCALE	
0-1 MA DC		1 MA			0-50 DC×1	0.5 UA
0-10 MA-DC		10 MA			0-10 DC÷10	0.01 MA
0-100 MA DC		100 MA			0-10 DC×1	0.10 MA
0-1000 MA DC		1000 MA			0-10 DC×10	1.0 MA
0-10 Amps DC		10 Amps			0-10 DC×100	10 MA
0-2000 Ohms	ΩMA-A DCV 10,000Ω/V	2K	Com	V-O-MA-A	GREEN SCALE	
0-200,000 Ohms		200K			0-2K ohms×1	
0-40 Megohms		40 Meg			0-200K ohms×1	
					0-40 Megohms×1	
-20 to +10 DB	Output	2.5 V	Com	V-O-MA-A	BLACK SCALE	
-8 to +22 DB		10 V			-20 to +10 DB plus 0	
+6 to +36 DB		50 V			-20 to +10 DB plus 12	
+20 to +50 DB		250 V			-20 to +10 DB plus 26	
+32 to +62 DB		1000 V			-20 to +10 DB plus 40	
+46 to +76 DB		5000 V			-20 to +10 DB plus 52	
			Com	5000V	-20 to +10 DB plus 66	

MAINTENANCE

BATTERY REPLACEMENT

One battery 1.5 volt and one 15 volt battery are provided for the ohmmeter circuit. These batteries may be easily replaced by removing the six screws holding the panel. When the ohmmeter circuit can no longer be adjusted by means of the variable resistance on the panel, replace the 1.5V battery with Eveready No. 935 or its equivalent, and the 15V battery with Eveready No. 411 or its equivalent.

Two connecting leads each 4 ft. long are provided for connecting to the jacks of the tester. For utmost safety, do not touch these leads when they are connected to a high voltage supply.

Two alligator clips are provided for fastening to the end of the test prods to make clip-on connections.

CARRYING CASE

Model 629 leather case for 625-NA

CAUTION

For Maximum Safety Do Not Handle Tester or Leads When Connected to High Voltages.

TESTER POSITION: Operate in a horizontal position for greatest accuracy.

HANDLING: Do not drop or severely jar the tester, as the pivots, jewels or moving element may be damaged.

POINTER SETTING: Be sure instrument pointer is on zero before taking any readings. The pointer may be set on zero by turning the bakelite screw just above the "OHMS ADJ."

HIGH VOLTAGE MEASUREMENTS: Exercise extreme caution. Make connections only with apparatus turned off. Make certain that no condensers are charged to a high voltage, such as filter condensers or power packs. Make certain switch is on 1000-5000V position.

High Voltage Testing Probes

Part T-79-83.....	0-10,000	D. C. Volts
Part T-79-74.....	0-10,000	A. C. Volts
Part T-79-130.....	0-25,000	D. C. Volts
Part T-79-75.....	0-25,000	A. C. Volts

Replacement Leads

LEADS for Models 630, 630-A, 666-HH, 666-R and 625-NA. Rubber (T-79-127).

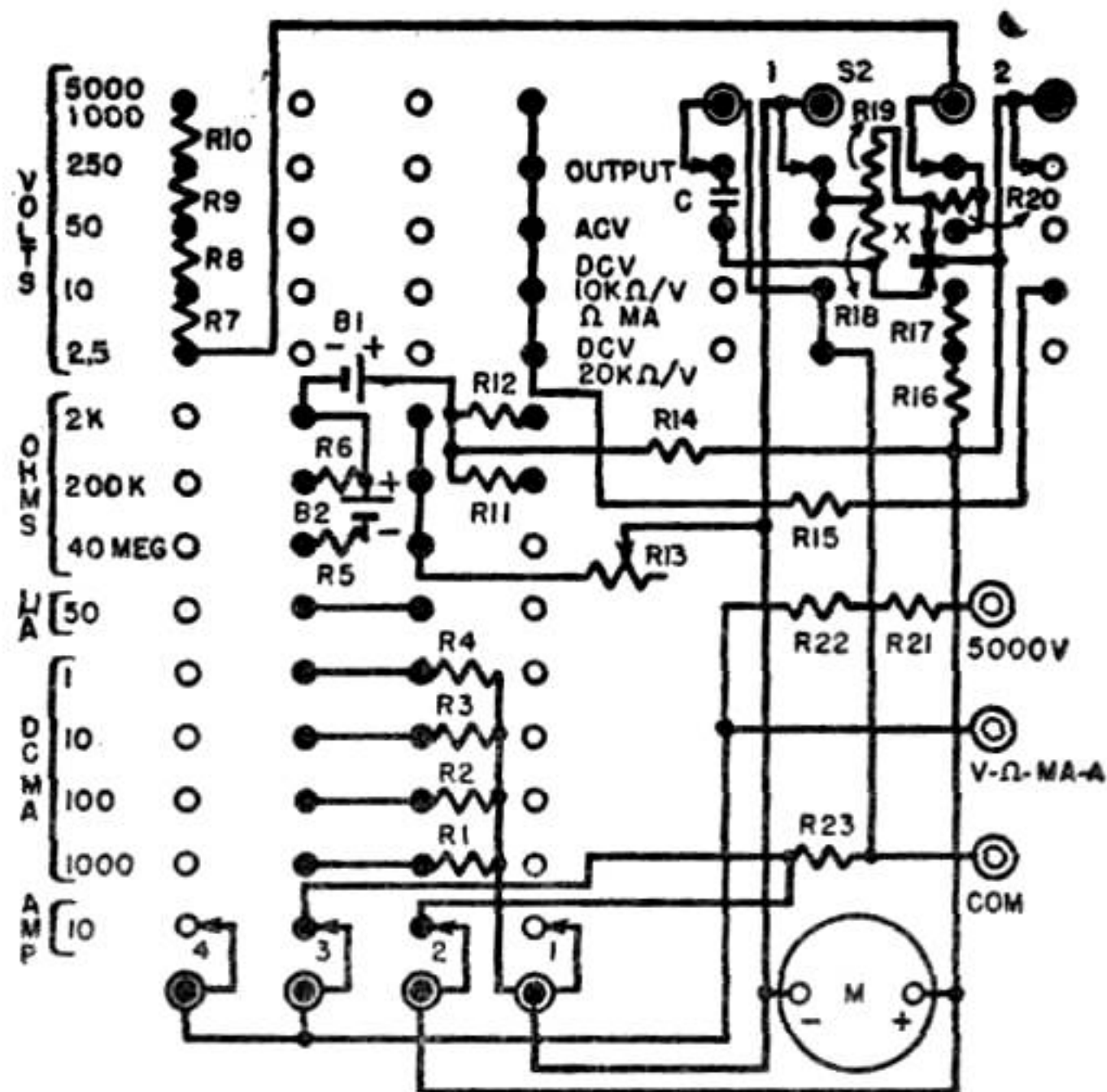

MODEL 625-NA WIRING DIAGRAM

PARTS LOCATION

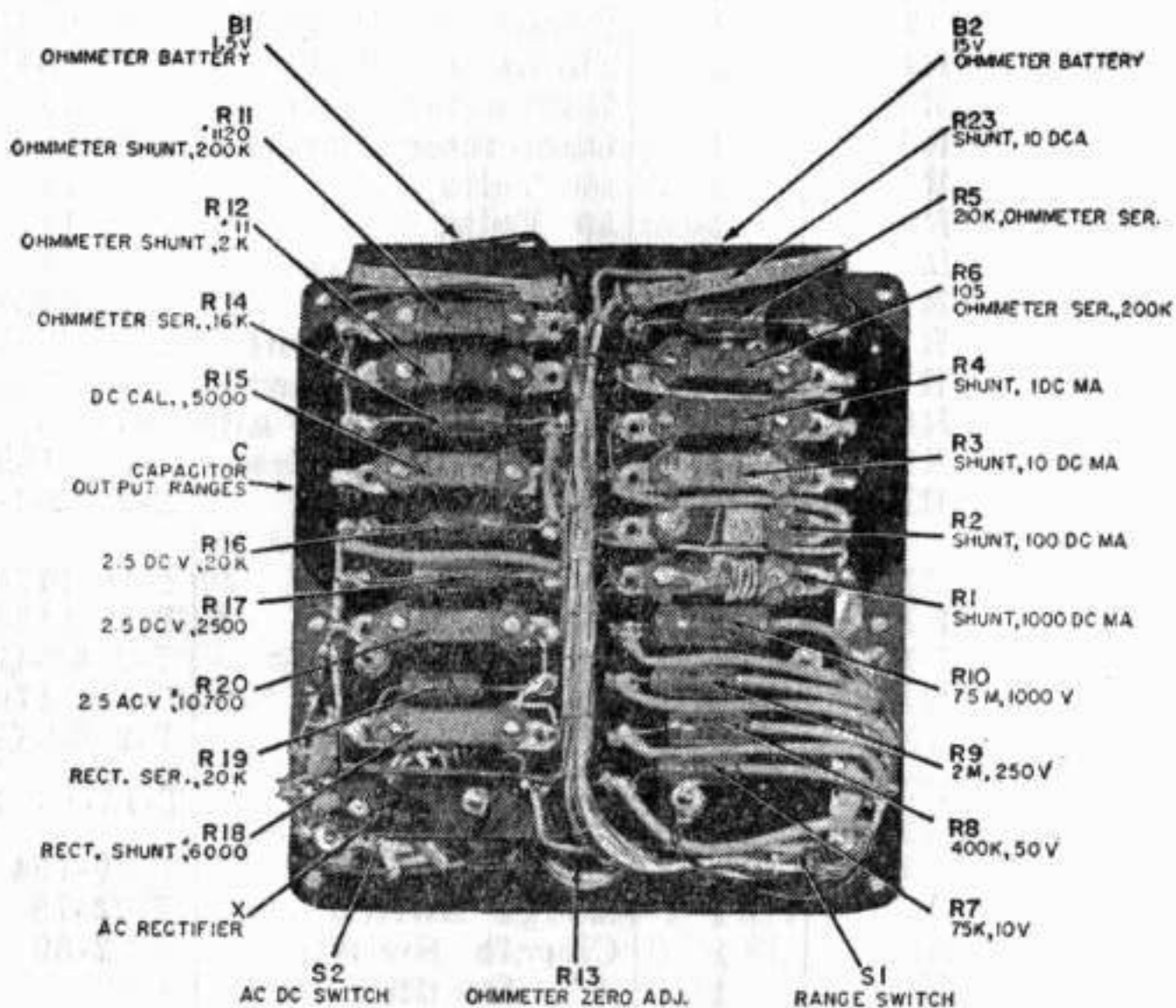

* APPROX. VALUE CALIBRATION RESISTOR

Model 625-NA

REF. NO.	QUAN.	FUNCTION	TRIPLETT PART NO.	PART NAME	DESCRIPTION
B1	1	Ohmmeter Battery	T-2426-2	Battery	1.5V Eveready 935 or equivalent
B2	1	Ohmmeter Battery	T-37-16	Battery	15V Eveready 411 or equivalent
C	1	Output Ranges	T-2631-P8	Capacitor	.1 Mfd 600 DCWV, paper
M	1	Indication	T-52-416	Instrument	50 Ua, 250 MV with panel
R1	1	Shunt 1000 DCMA	T-2603-C-.263	Resistor	.263* ohm wirewound 1W
R2	1	Shunt 100 DCMA	T-2603-C-2.63	Resistor	2.63* ohm wirewound 1W
R3	1	Shunt 10 DCMA	T-2603-C-26.31	Resistor	26.31* ohm wirewound 1W
R4	1	Shunt 1 DCMA	T-2603-C-263.1	Resistor	263.1* ohm wirewound 1W
R5	1	Ohmmeter Series	T-15-1165	Resistor	210K ohm $\pm 1\%$ Film $\frac{1}{2}$ W
R6	1	Ohmmeter Series	T-2603-C-105	Resistor	105* ohm Wirewound 1W
R7	1	10 Volts	T-15-1166	Resistor	75K ohm $\pm 1\%$ Film $\frac{1}{2}$ W
R8	1	50 Volts	T-15-1167	Resistor	400K ohm $\pm 1\%$ Film $\frac{1}{2}$ W
R9	1	250 Volts	T-15-1168	Resistor	2 Megohm $\pm 1\%$ Film $\frac{1}{2}$ W
R10	1	1000 Volts	T-15-1006	Resistor	7.5 Megohm $\pm 1\%$ Film 1W
R11	1	Ohmmeter Shunt	T-2603-C-1120	Resistor	1120* ohm wirewound 1W
R12	1	Ohmmeter Shunt	T-2603-C-11	Resistor	11* ohm Wirewound 1W
R13	1	Ohmmeter Zero Adj	T-16-24	Resistor	20K ohm Variable
R14	1	Ohmmeter Series	T-15-1169	Resistor	16K ohm $\pm 1\%$ Film $\frac{1}{2}$ W
R15	1	DC Calibrating 1000 ohm/V	T-2603-1-5000	Resistor	5K ohm $\pm 1\%$ Wirewound 1W
R16	1	2.5V DC	T-15-1170	Resistor	20K ohm $\pm 1\%$ Film $\frac{1}{2}$ W
R17	1	2.5V DC	T-15-1134	Resistor	2500 ohm $\pm 1\%$ Film $\frac{1}{2}$ W
R18	1	Rectifier Shunt	T-2603-C-6000	Resistor	6000* ohm Wirewound 1W
R19	1	Rectifier Series	T-15-1170	Resistor	20K ohm $\pm 1\%$ Film $\frac{1}{2}$ W
R20	1	2.5V AC	T-2603-C-10700	Resistor	10700* ohm Wirewound 1W
R21 } R22 }	2	5000 Volts	T-15-1674	Resistor	20 Megohm $\pm 1\%$ Film 2W
R23	1	Shunt 10A DC	T-90-164	Shunt	10 Amp 250 MV Strip type
S1	1	Range Switch	T-22-78	Switch	14 Pos. 4 Deck Cutoff
S2	1	Circuit Switch	T-22-80	Switch	14 Pos. 2 Deck 4 Pole 4 Throw
X	1	AC Rectifier	8679	Rectifier	Copper Oxide, Conant BT-160 3 Lead
	1	Tester Housing	T-10-599	Case	Bakelite with strap handle
	2	Connections	T-2563-A	Clip	Alligator, Mueller No. 60
	2	Connections	T-33-13	Jack	Red for banana plug
	2	Connections	T-33-12	Jack	Black for banana plug
	2	Switch Knobs	5804	Knob	Bar $1\frac{1}{4}$ " long
	1	Ohms Adj. Knob	T-2558-1	Knob	Round $11/16$ OD
	1 Pr.	Connections	T-79-127	Leads	Banana plug type

*Approx. Value Calibration Resistor

CONDITIONS OF SALE

The Triplet Electrical Instrument Company warrants instruments manufactured by it to be free from defective material or factory workmanship and agrees to repair or replace such instruments which under normal use and service, disclose the defect to be the fault of our manufacturing. Our obligation under this warranty is limited to repairing or replacing any instrument or test equipment which proves to be defective, when returned to us transportation prepaid, within ninety (90) days from date of original purchase.

This warranty does not apply to any of our products which have been repaired or altered by unauthorized persons or service stations in any way so as, in our judgment, to injure their stability or reliability or which have been subject to misuse, negligence, or accident, or which have had the serial number altered, effaced, or removed. Neither does this warranty apply to any of our products which have been connected, installed, or adjusted otherwise than in accordance with the instructions furnished by us. Accessories including all vacuum tubes and batteries not of our manufacture used with this product are not covered by this warranty.

The Triplet Electrical Instrument Company reserves the right to discontinue models at any time, or change specifications or design, without notice and without incurring any obligation.

Upon acceptance of the material covered by this invoice the purchaser agrees to assume all liability for any damages and bodily injury which may result from the use or misuse of the material by the purchaser, his employees, or others, and that The Triplet Electrical Instrument Company shall incur no liability for direct or consequential damage of any kind.

This warranty and conditions of sale are in lieu of all others expressed or implied and no representative or person is authorized to assume for us any other liability in connection with the sale of our products.

TRIPLETT V-O-M for every need in Laboratory - Production - Maintenance Servicing

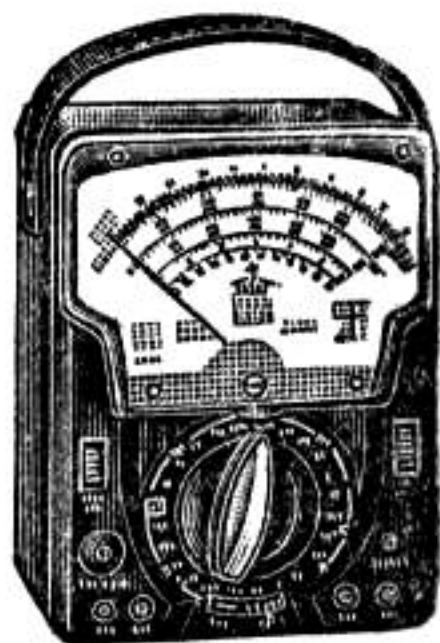

631

**Combination
V-O-M—VTVM**

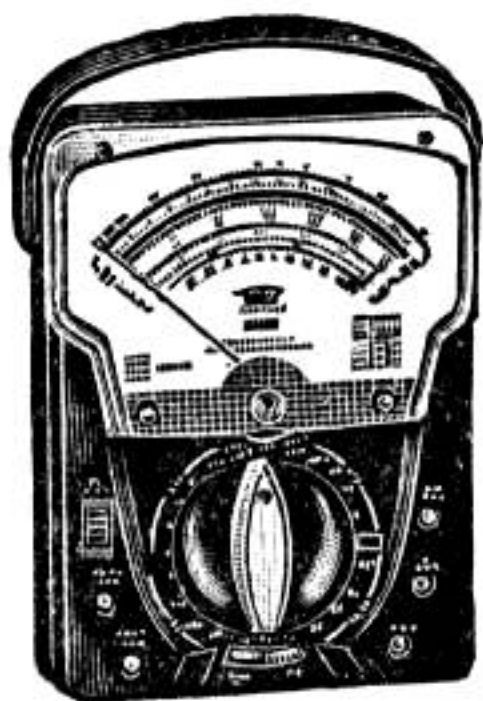

630-NA

**For Best Testing
Around The Lab.
Production Line
or Bench**



310

**The Smallest
Complete V-O-M
With Switch**

**TRIPLETT ALSO MANUFACTURES
A COMPLETE LINE OF TEST
EQUIPMENT AND PANEL METERS**

**The Triplett Electrical Instrument Co.
BLUFFTON, OHIO**

Printed in U. S. A.

Part No. 84-16-022059-23